

Capitán Hairs

ATLAS

PERTENECIENTE

al tratado de la teoría y fabricación

DE LA

PÓLVORA EN GENERAL,

LAS PIEZAS DE ARTILLERÍA

Y

LOS PROYECTILES DE HIERRO,

POR LOS CORONELES GRADUADOS, CAPITANES DE ARTILLERÍA

DON CLAUDIO DEL FRAXNO y DON JOAQUIN DE BOULIGNY,

profesor y ayudante de la clase de ciencias naturales de la academia de su arma.

SEGUIDO

del artículo sobre fundición de artillería de bronce, redactado de orden superior por el Coronel 1.^{er} Comandante del mismo cuerpo

DON PEDRO LUJAN,

fundidor mayor de Sevilla.

PARA SERVIR DE TESTO EN LA ENSEÑANZA DE LOS CABALLEROS CADETES DE ARTILLERÍA.



SEGOVIA:

IMPRESA DE D. EDUARDO BAEZA.

1848.

1/ Audite
c-7



R. 124041

ATLAS

PERTENECIENTE

al tratado de la teoría y fabricación

DE LA

PÓLVORA EN GENERAL,

LAS PIEZAS DE ARTILLERÍA

Y

LOS PROYECTILES DE HIERRO.

POR LOS CORONELES GRADUADOS, CAPITANES DE ARTILLERÍA

DON CLAUDIO DEL FRAXNO y DON JOAQUIN DE BOULIGNY,

profesor y ayudante de la clase de ciencias naturales de la academia de su arma.

SEGUIDO

del artículo sobre fundición de artillería de bronce, redactado de orden superior por el Coronel 1.^{er} Comandante del mismo cuerpo

DON PEDRO LUJAN,

fundidor mayor de Sevilla.

PARA SERVIR DE TESTO EN LA ENSEÑANZA DE LOS CABALLEROS CADETES DE ARTILLERÍA.



SEGOVIA:

IMPRENTA DE D. EDUARDO BAEZA.

1848.

ATLAS

PERUANO

de la teoría y fabricación

DE LA

PÓLVORA EN GENERAL,

Y SUS VARIAS ESPECIES

LOS PROYECTILES DE HIERRO.

LOS AUTORES DON CLAUDIO DEL BRAZZO Y DON JOSE DE BOLLIGNY

DON CLAUDIO DEL BRAZZO Y DON JOSE DE BOLLIGNY

Profesor y ayudante de la clase de ciencias militares de la Academia de Artillería

SEGUNDO

del artículo sobre fundición de artillería de bronce, redactado de orden superior por el Coronel J. Co- mandante del mismo cuerpo

DON PEDRO LAYAN

Impreso en la imprenta de la Real Academia de Artillería

HAZ SEPTIEMBRE DE 1845 EN LA IMPRENTA DE LA REAL ACADEMIA DE ARTILLERÍA



PERUANO

DE LA

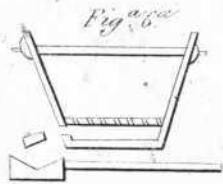
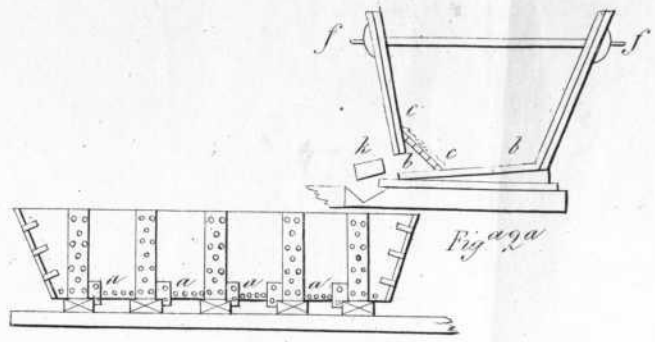
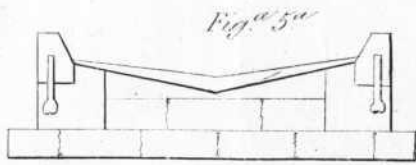
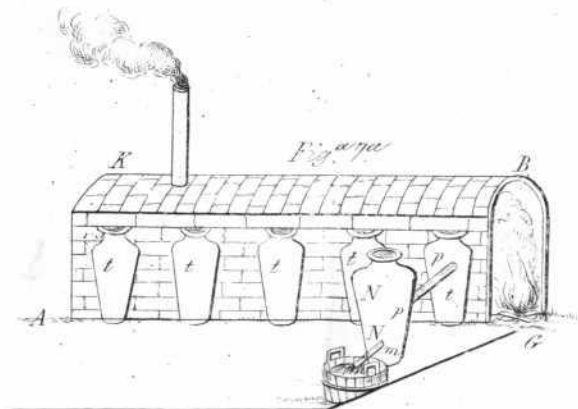
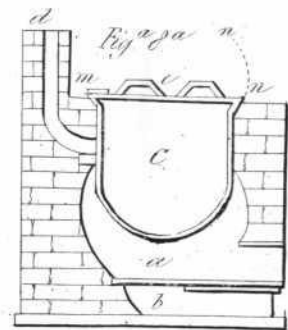
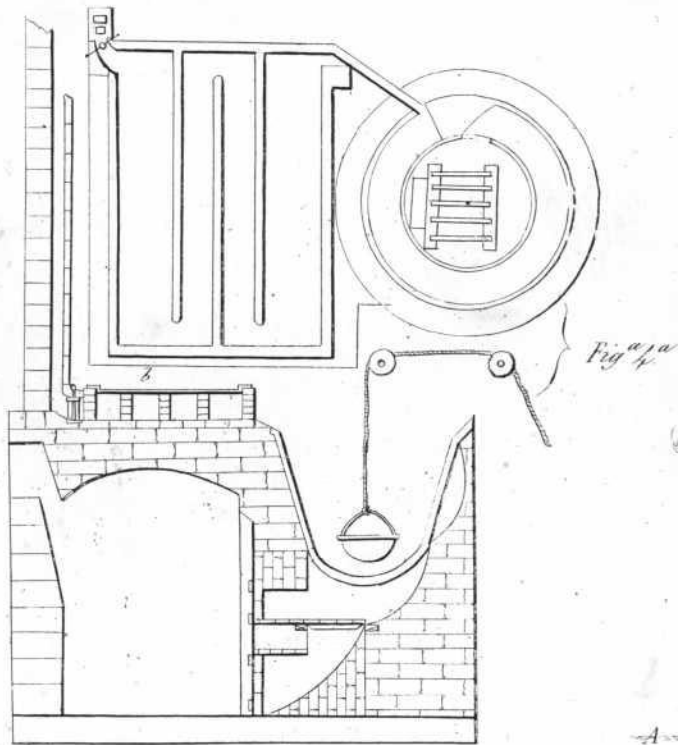
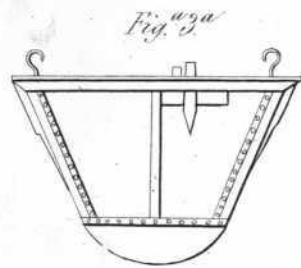
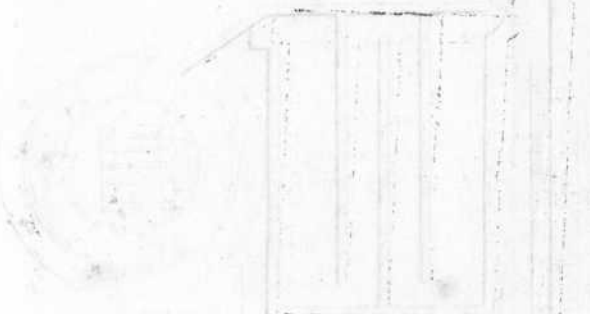
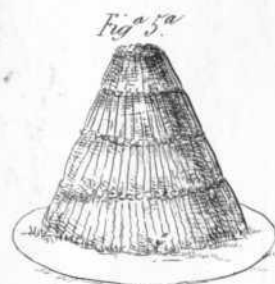
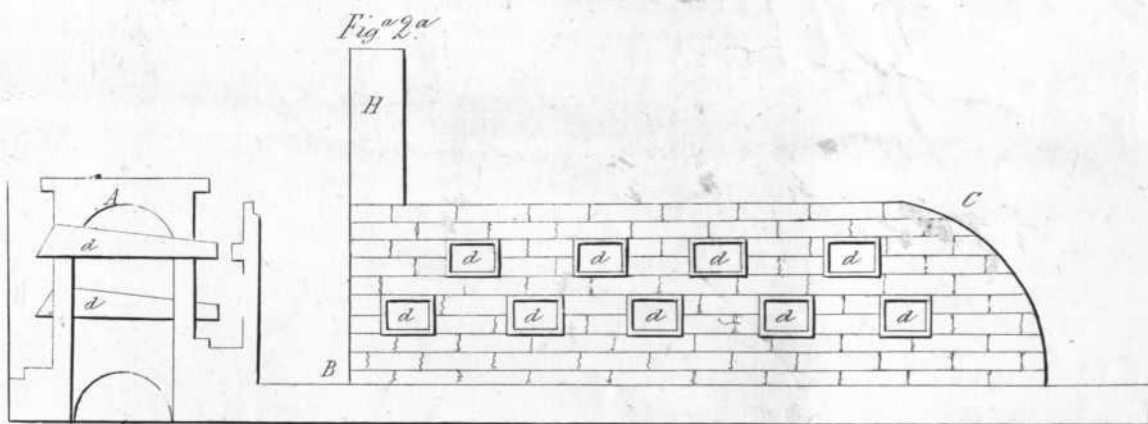
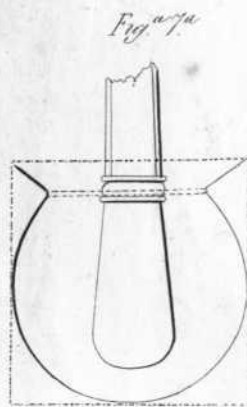
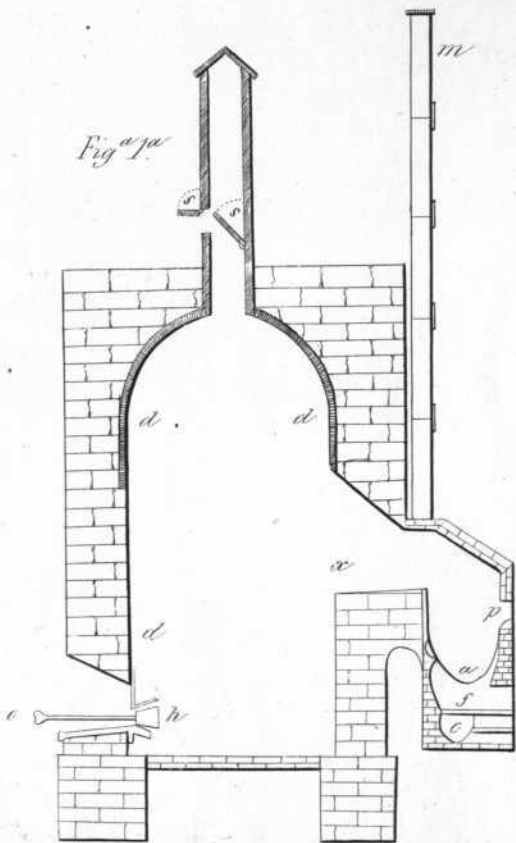


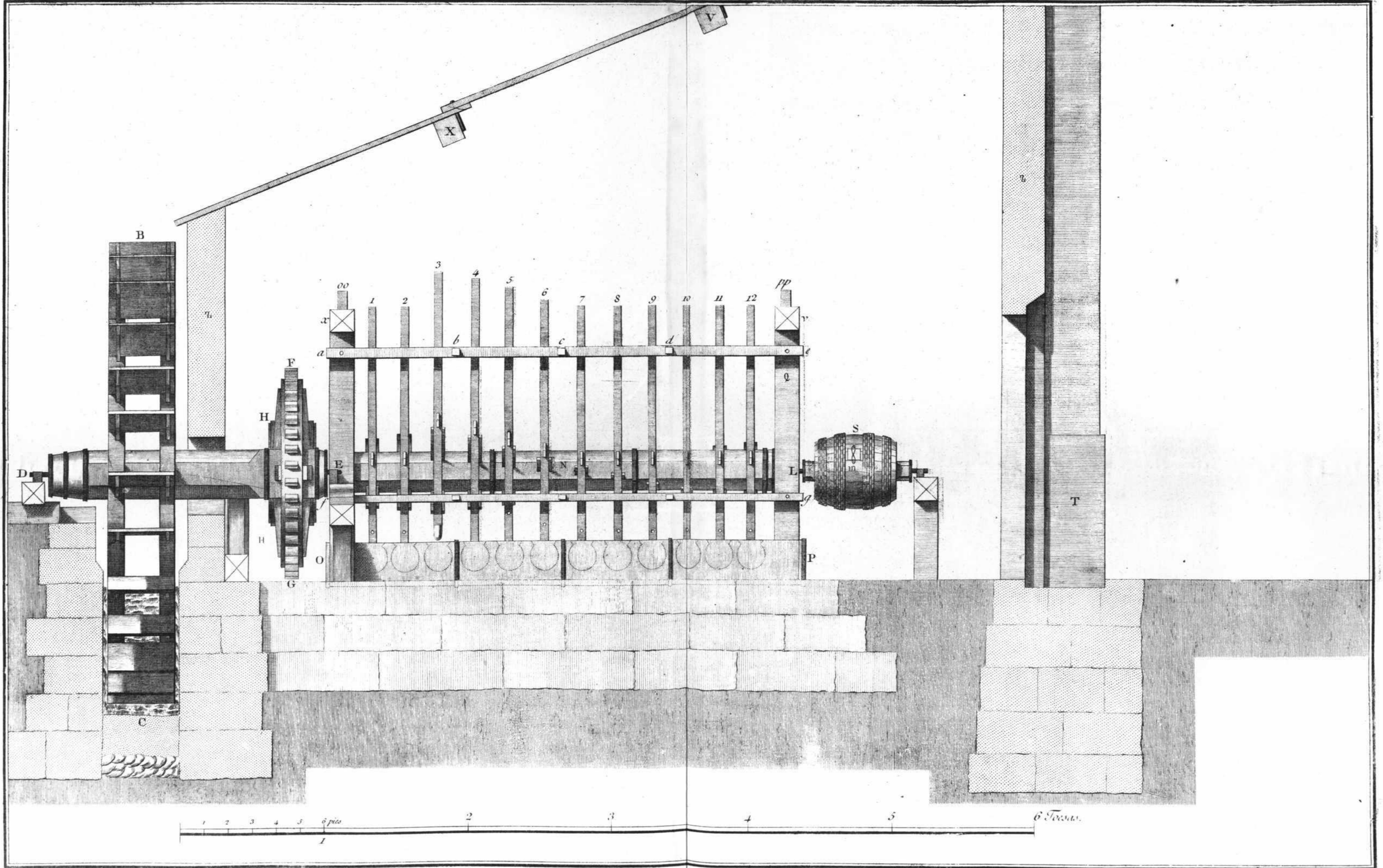
Fig. 1^a

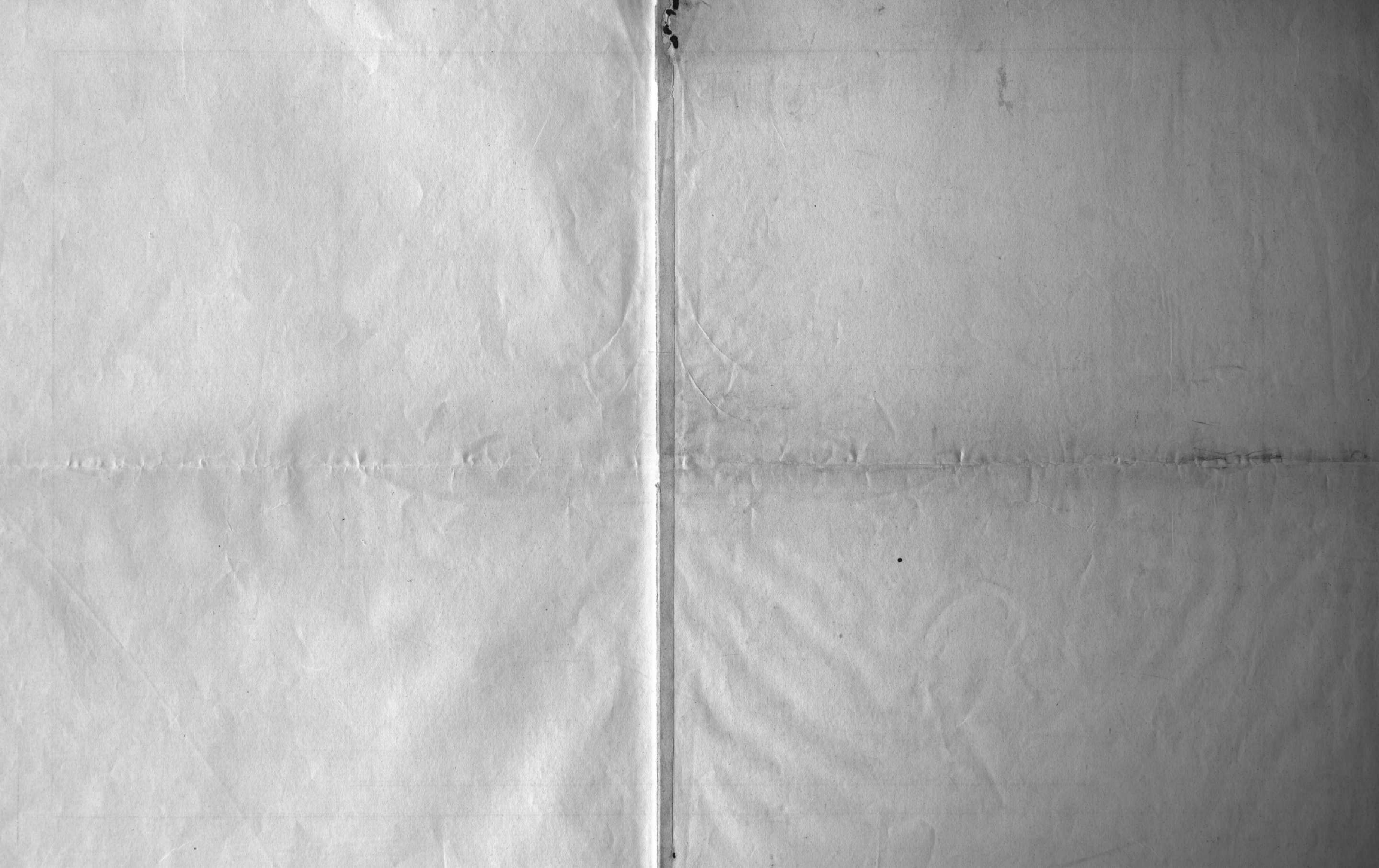


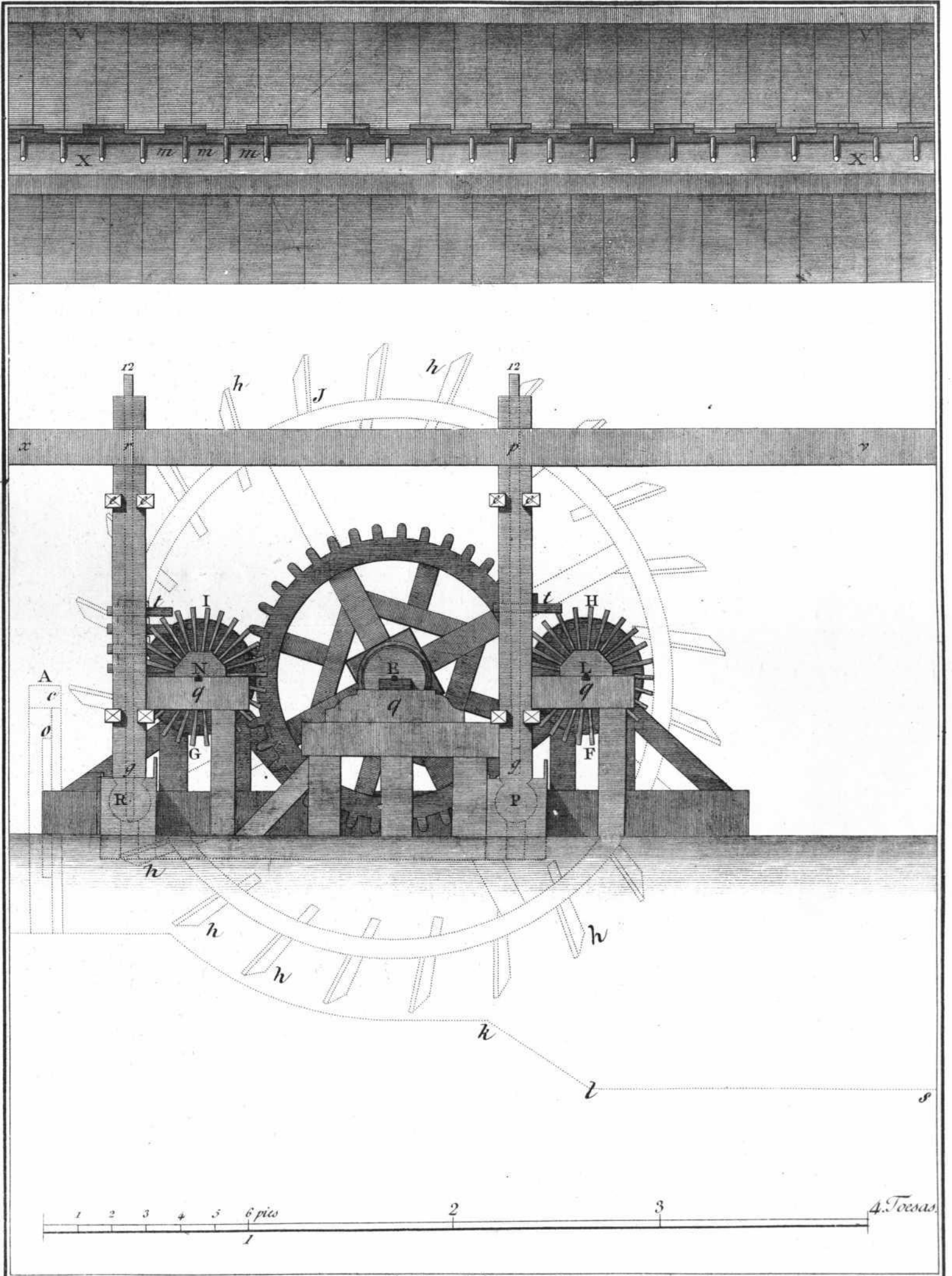












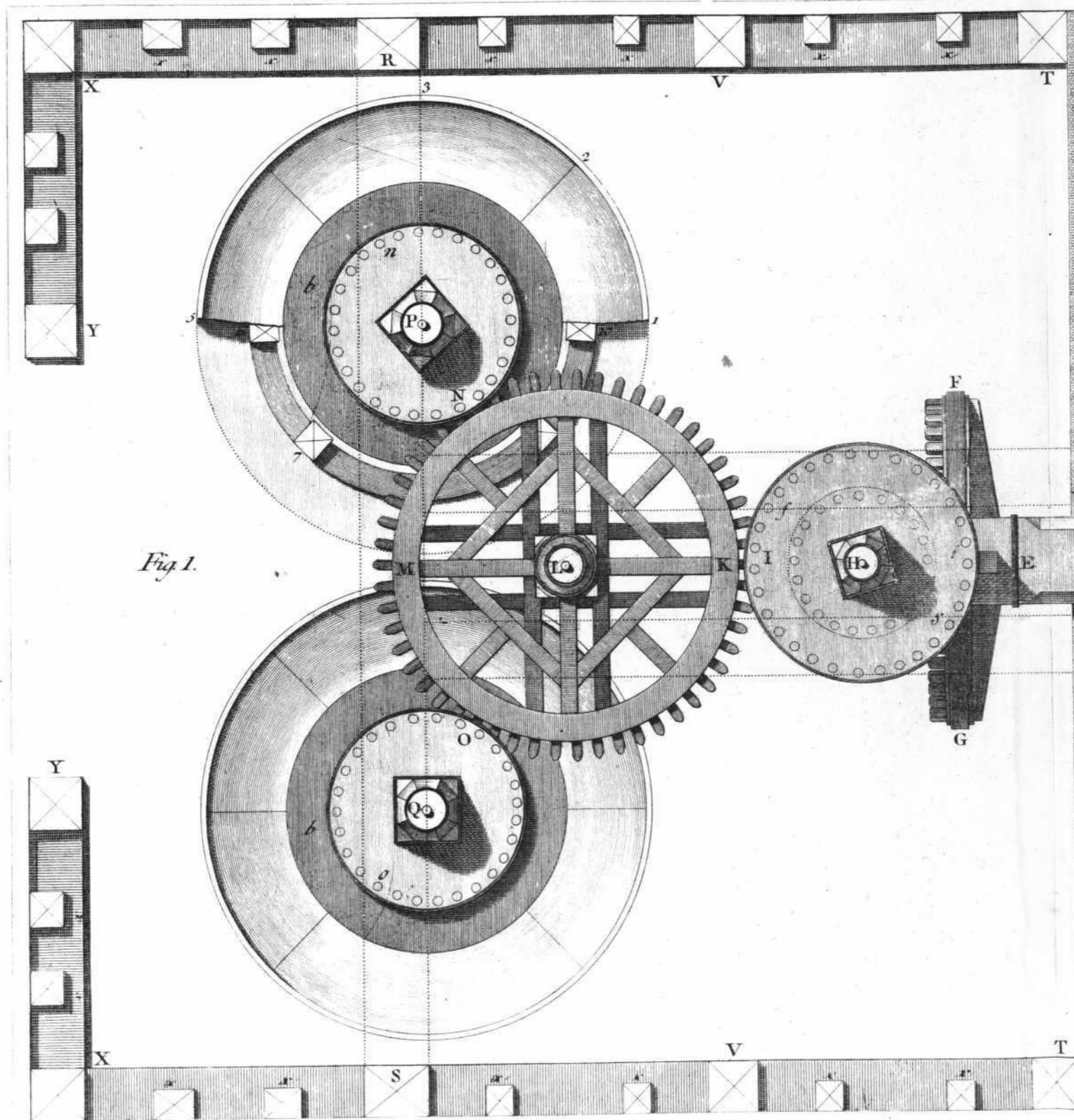


Fig. 1.

1 2 3 4 5 6 pices
 1 2 3 Toises.

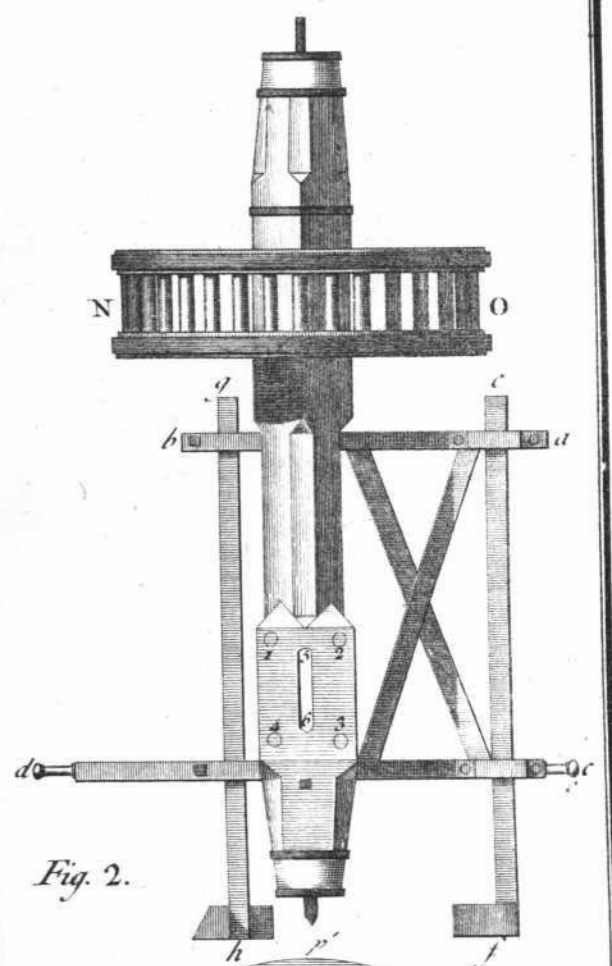
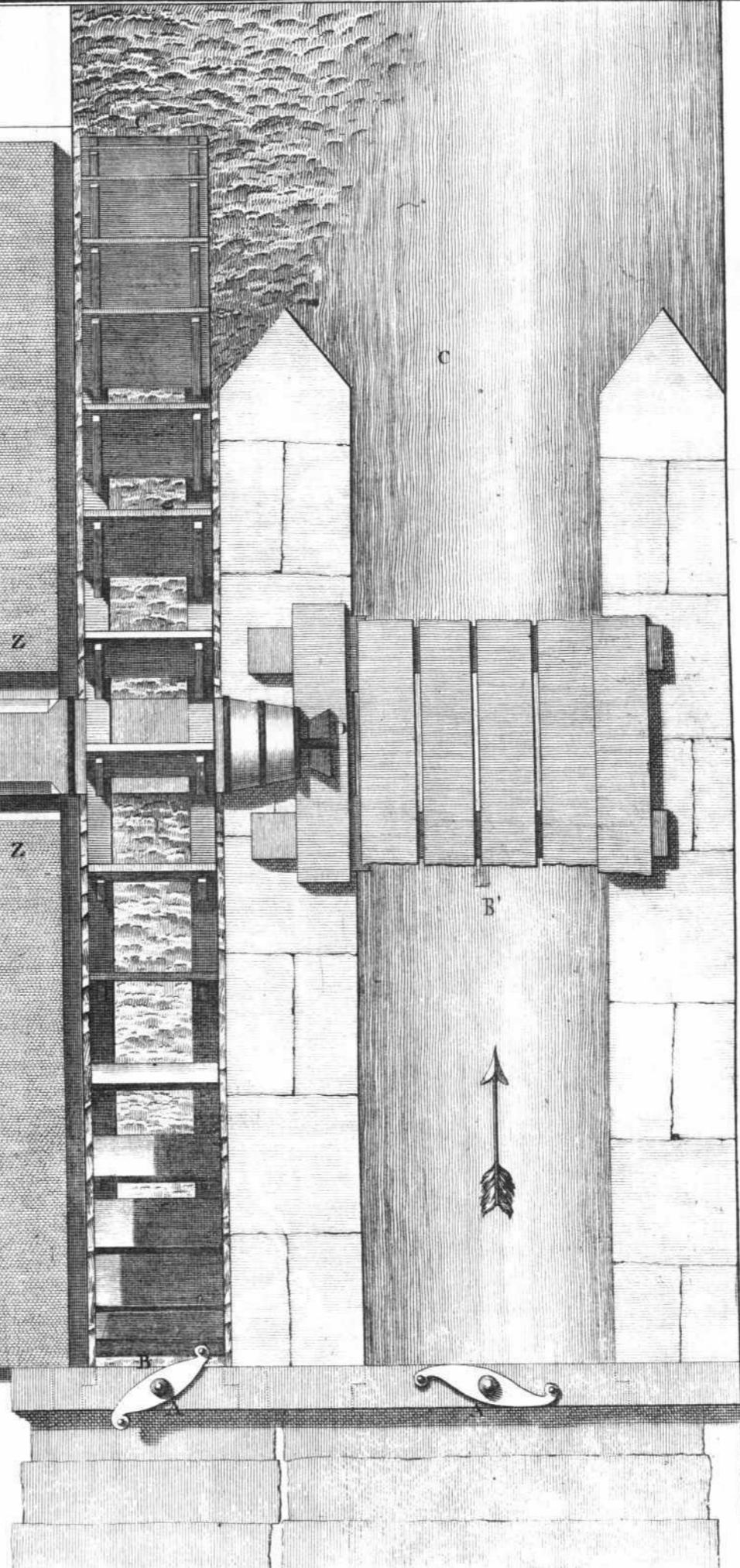


Fig. 2.

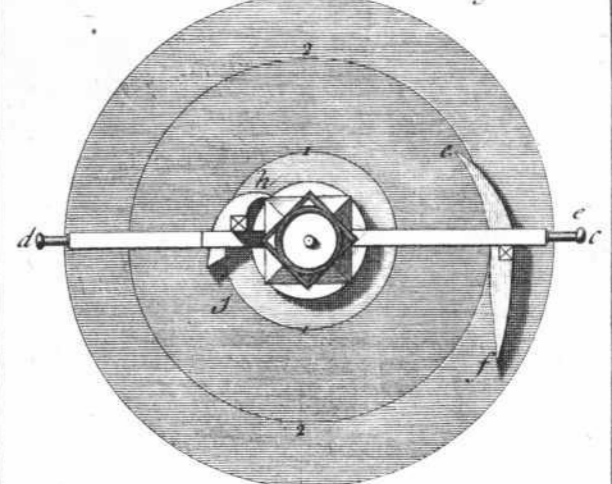
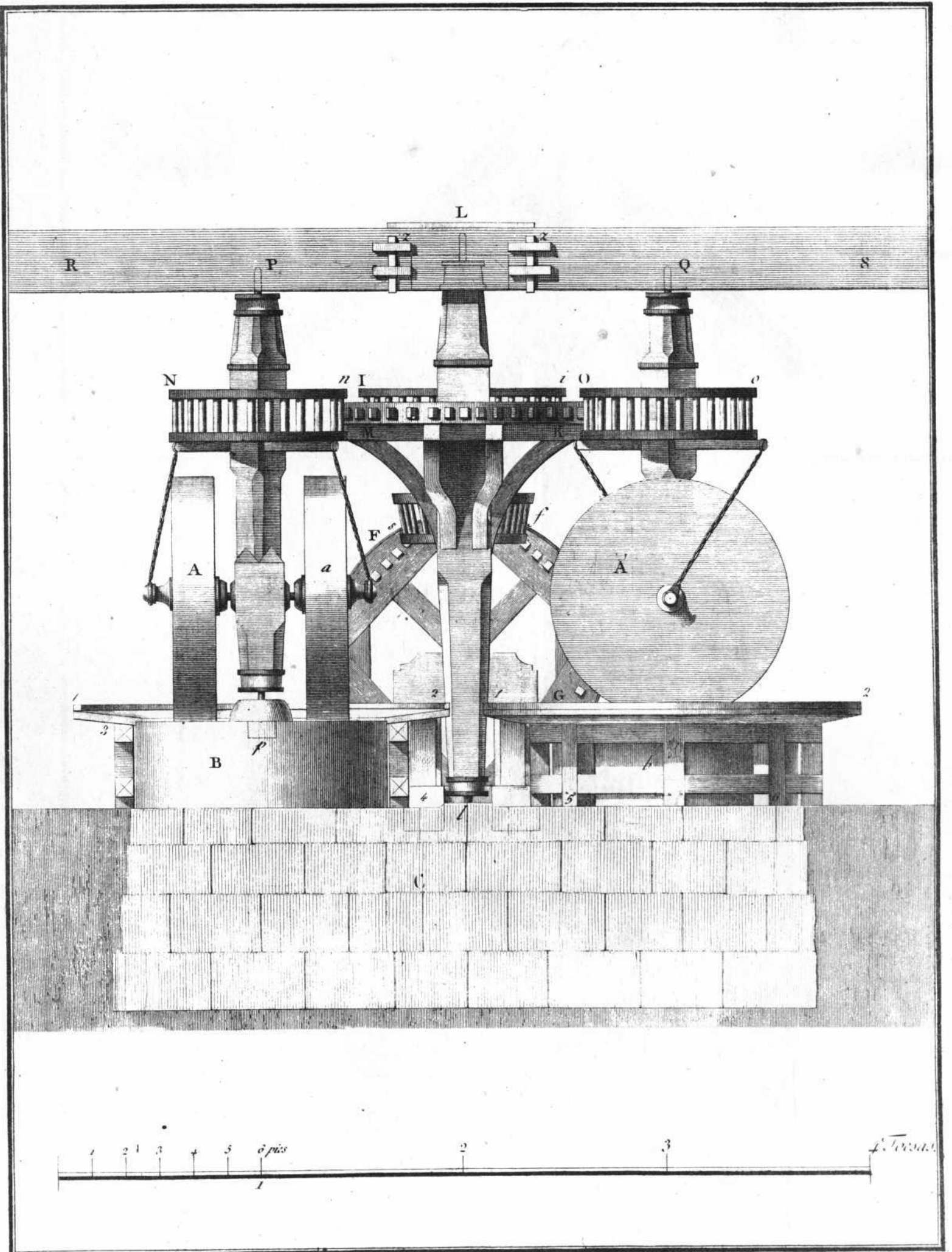
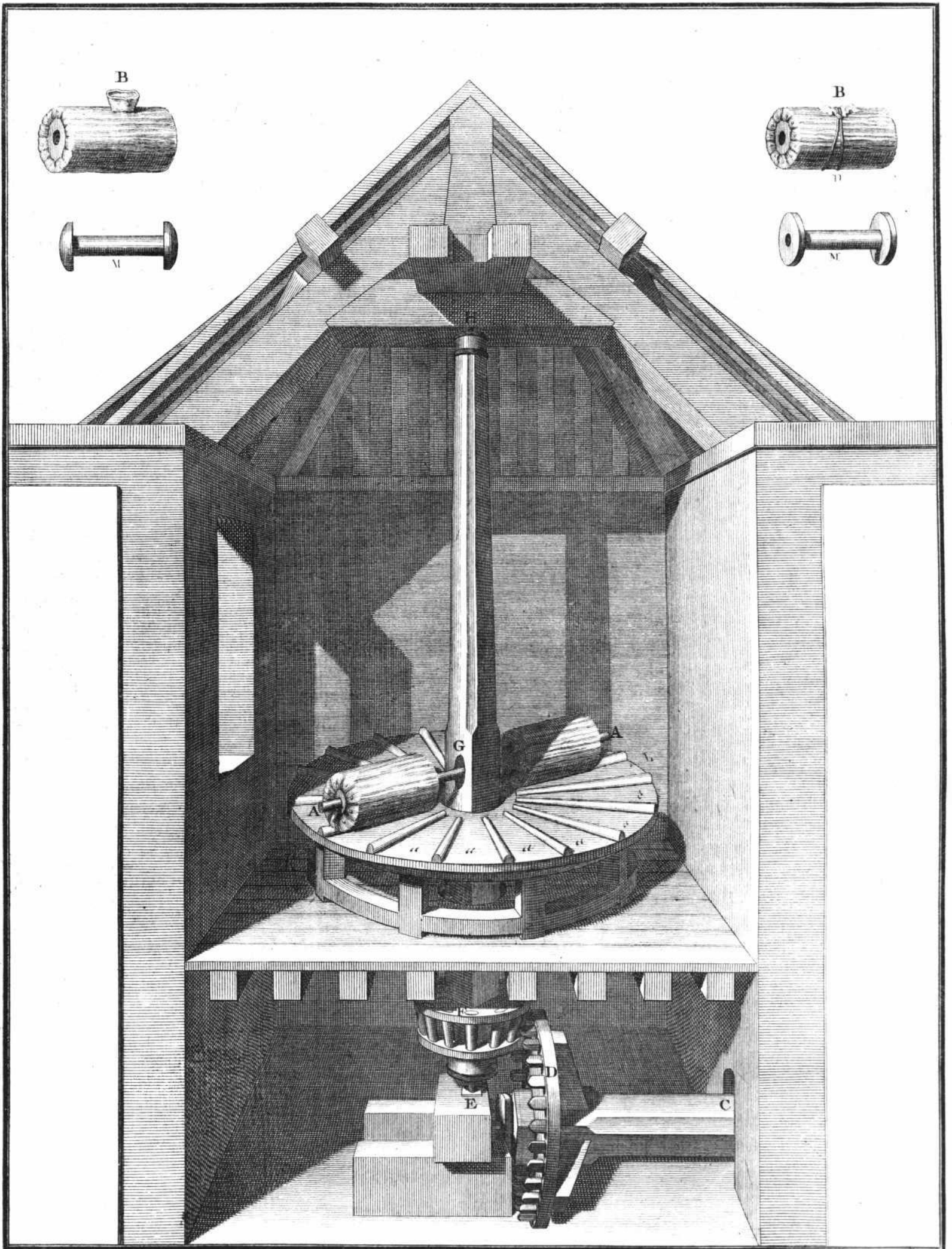


Fig. 3.

1 2 3 4 5 6 pices
 1 Toises.







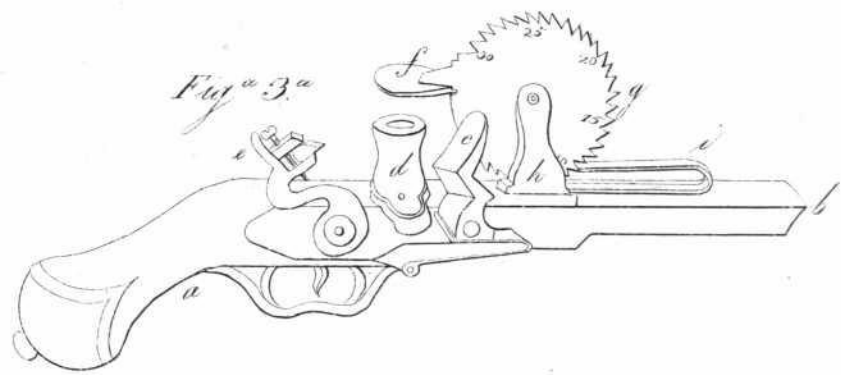
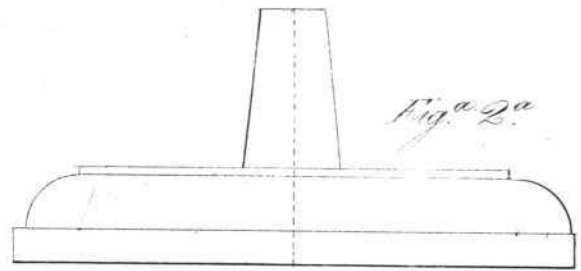
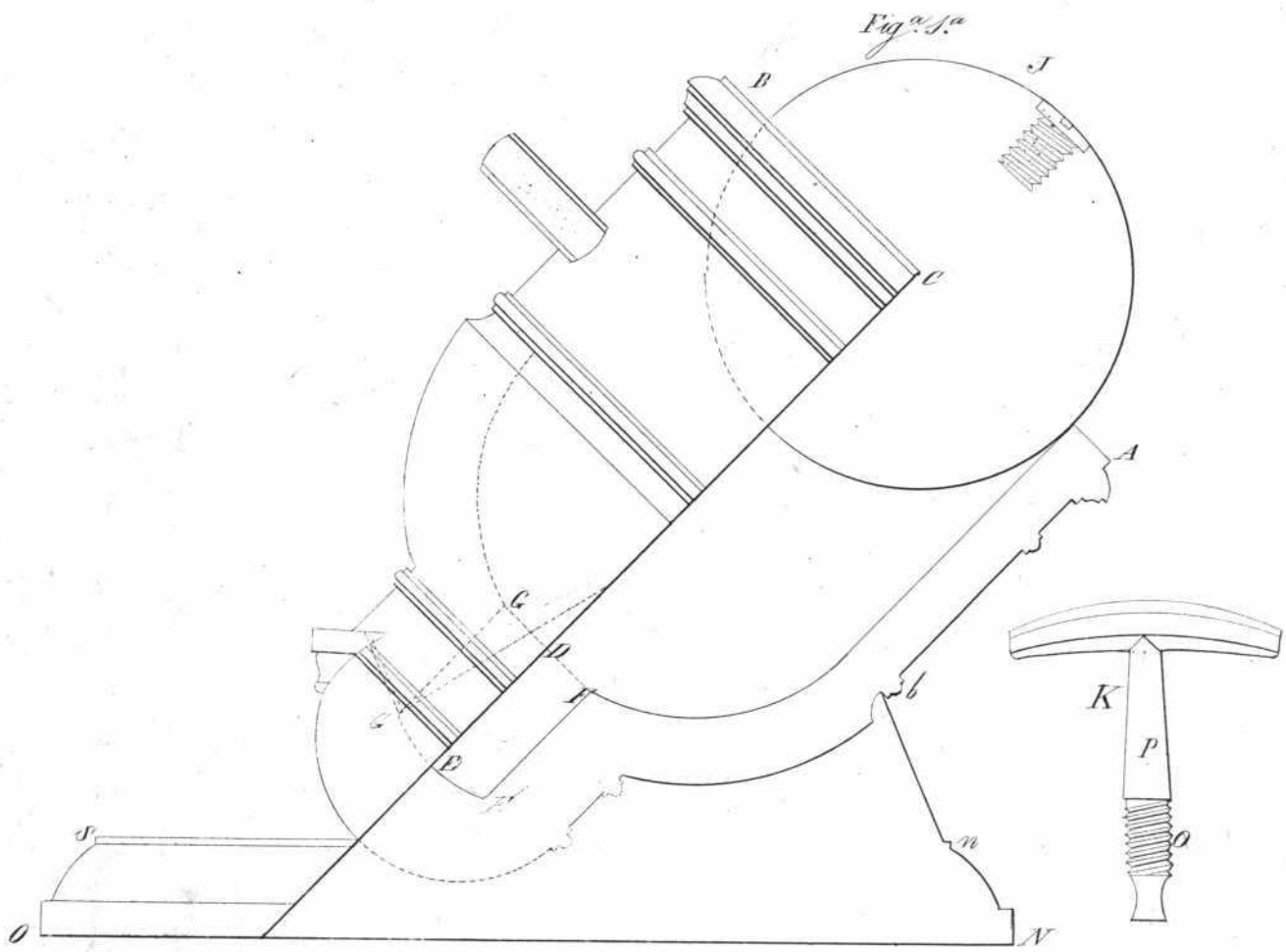


Fig. 1.

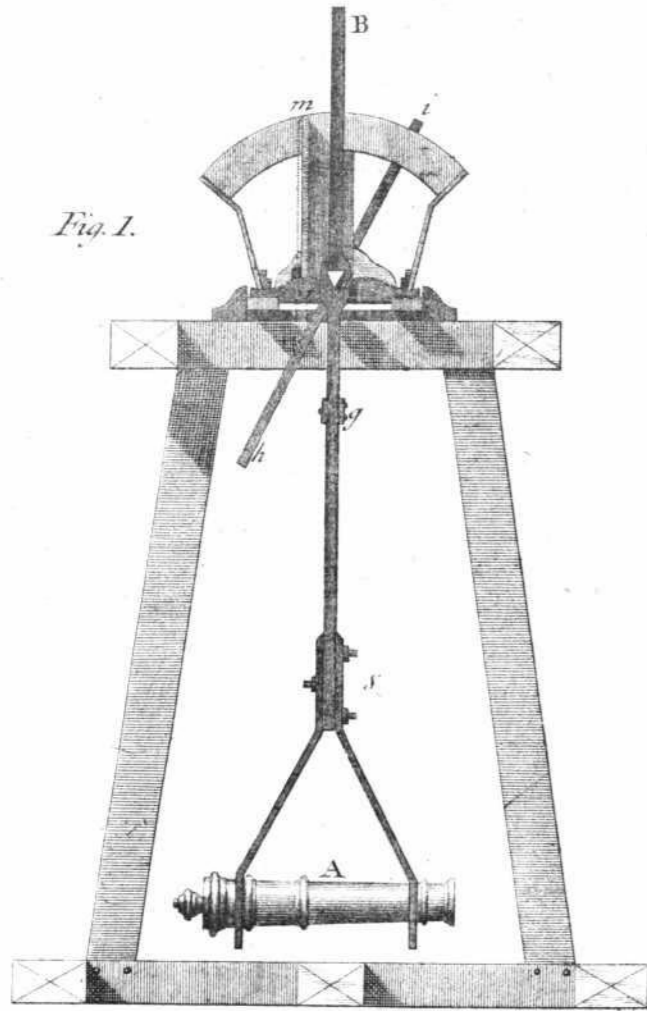


Fig. 2.

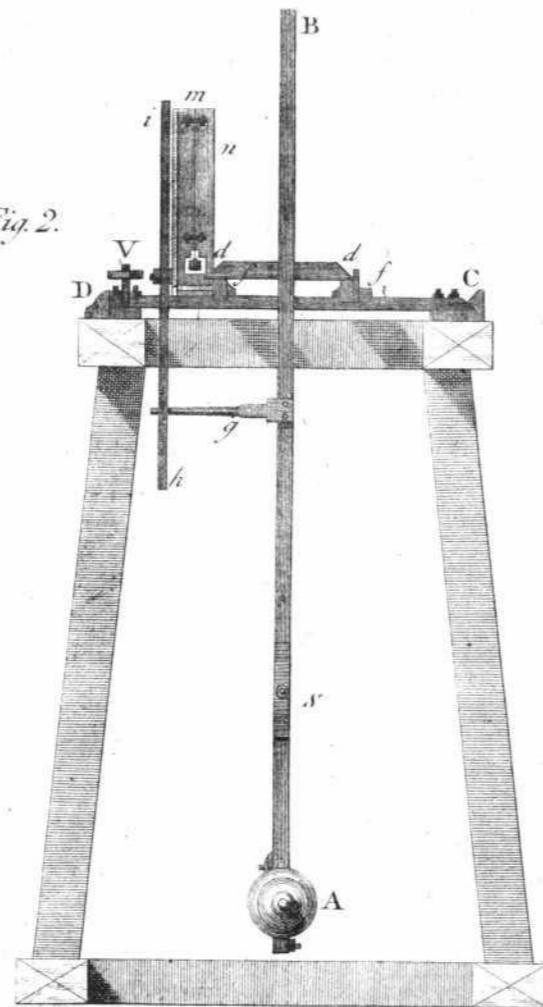


Fig. 4.

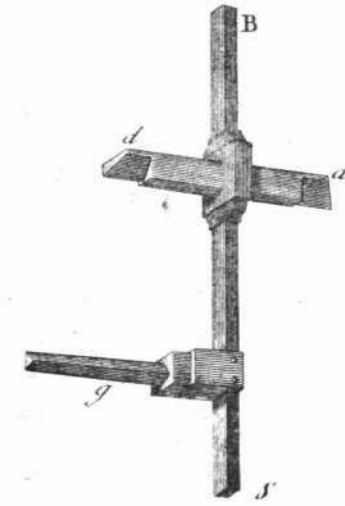
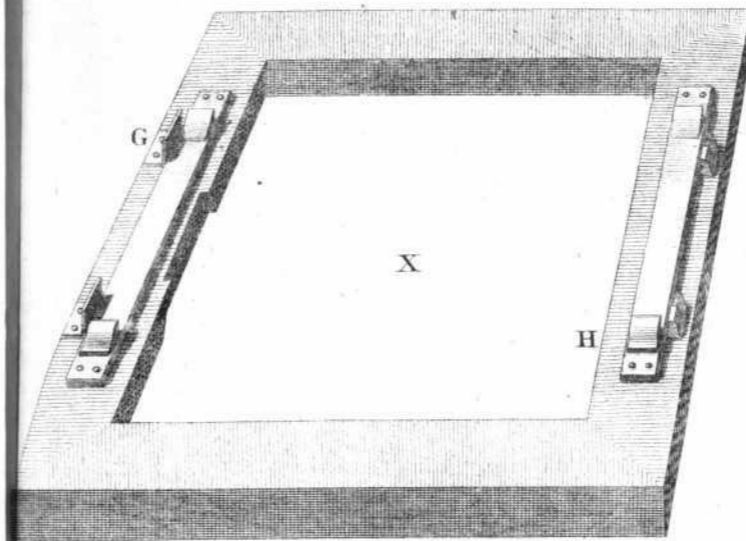


Fig. 6.

Fig. 3.

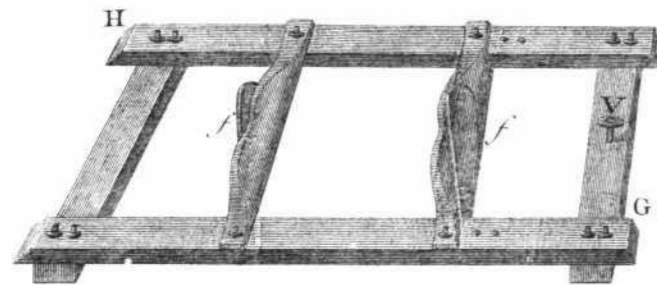


Fig. 5.

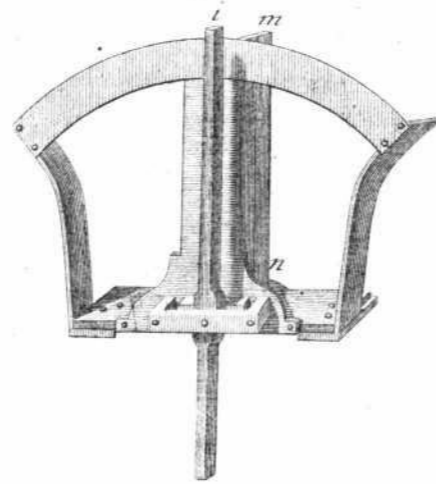
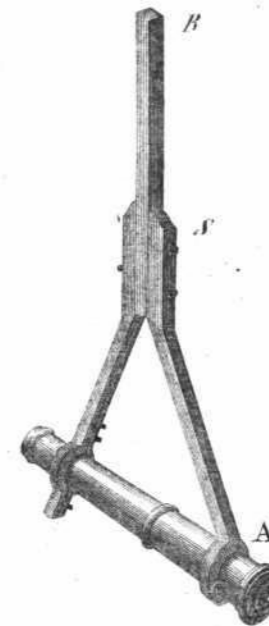
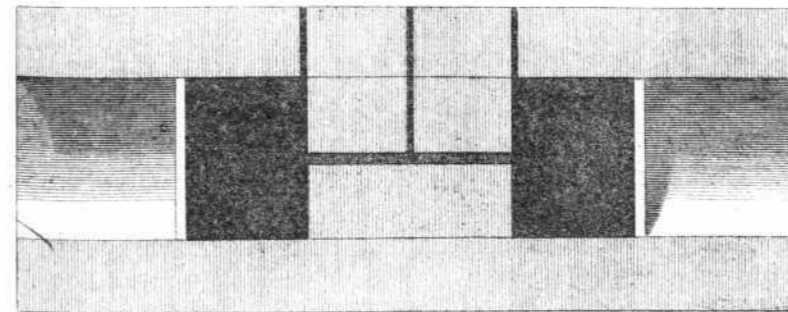
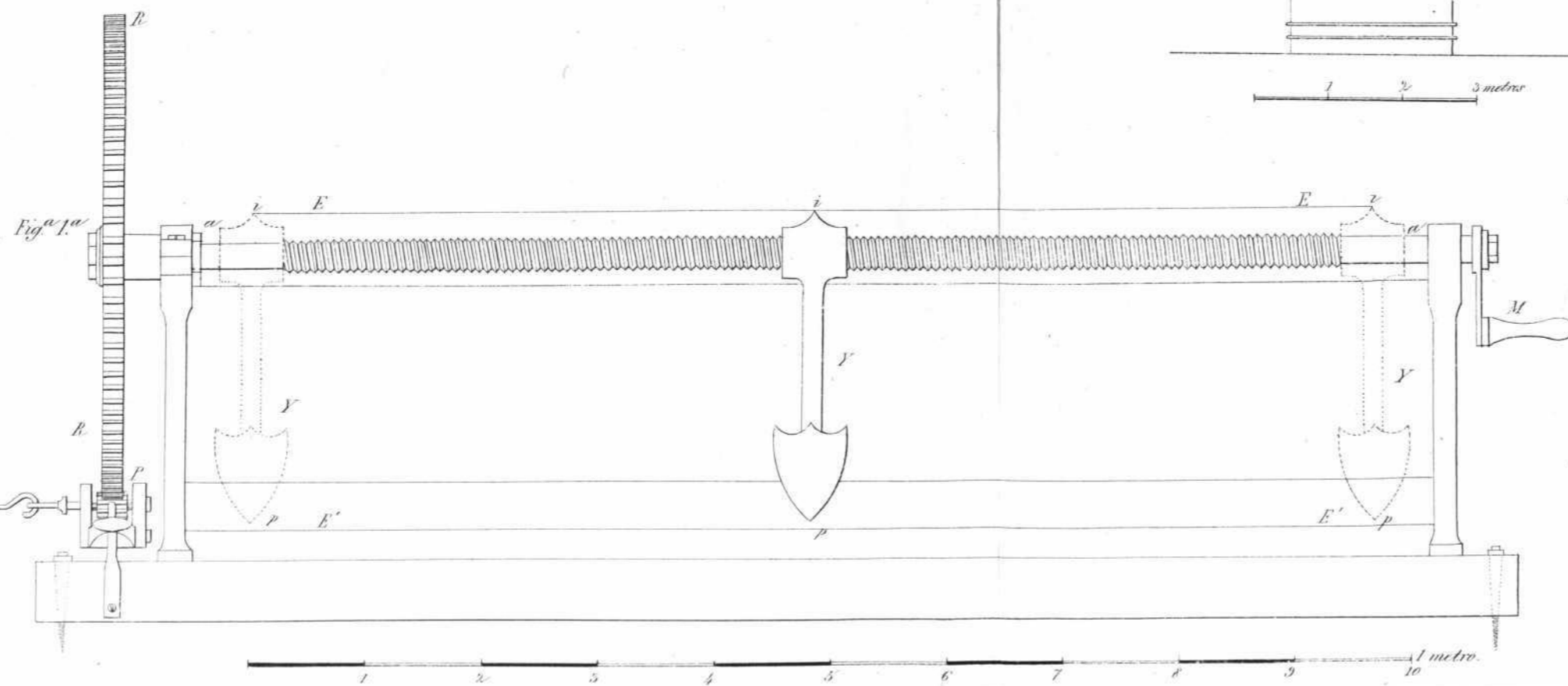
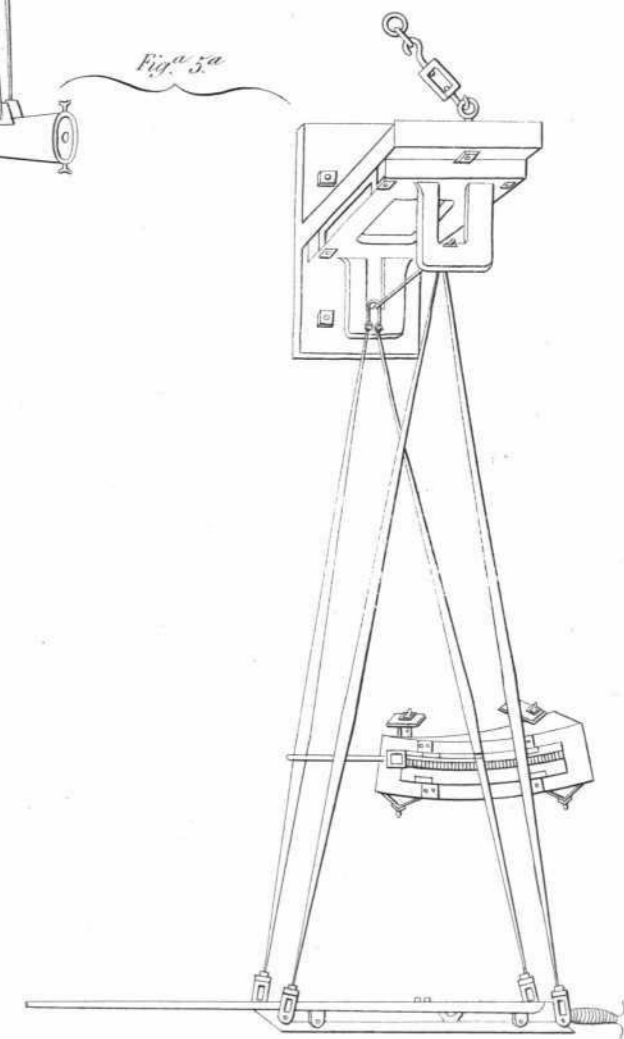
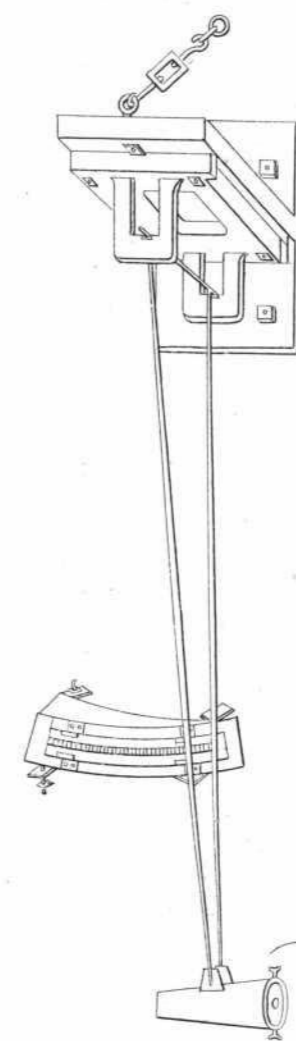
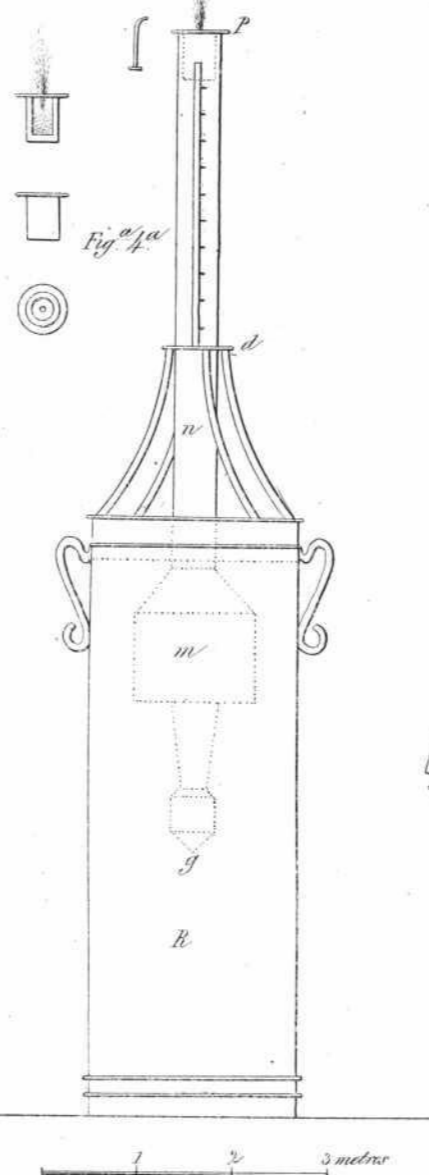
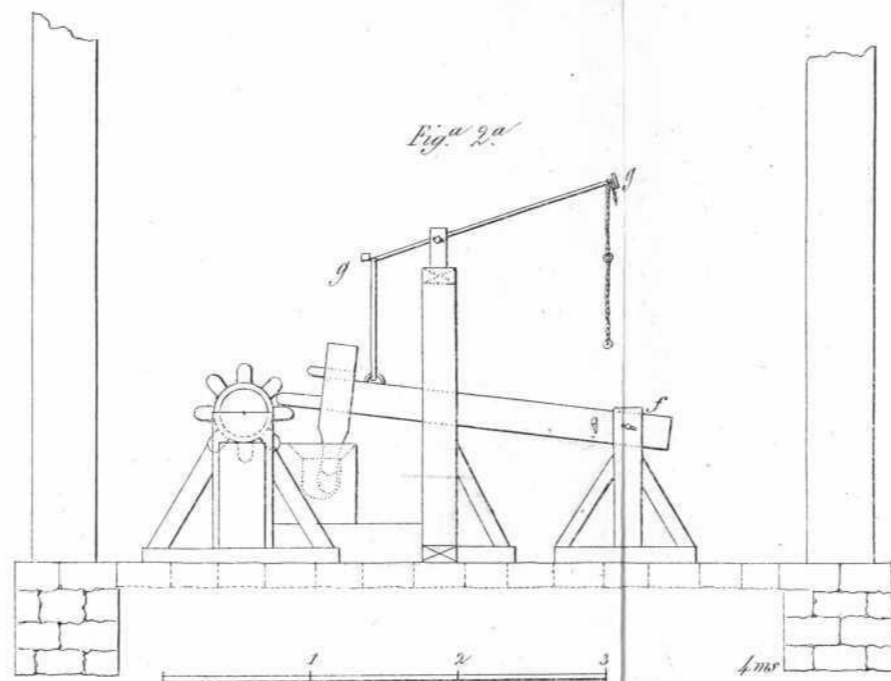
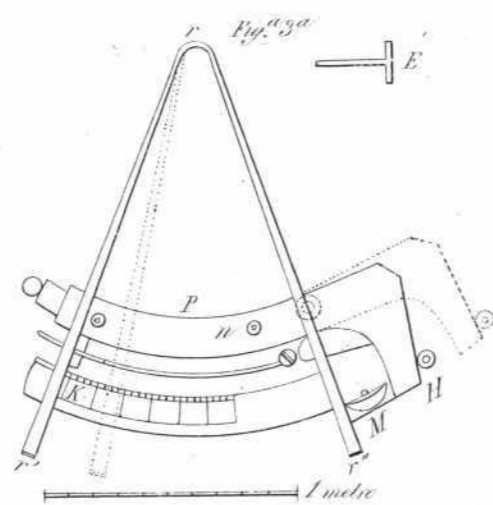
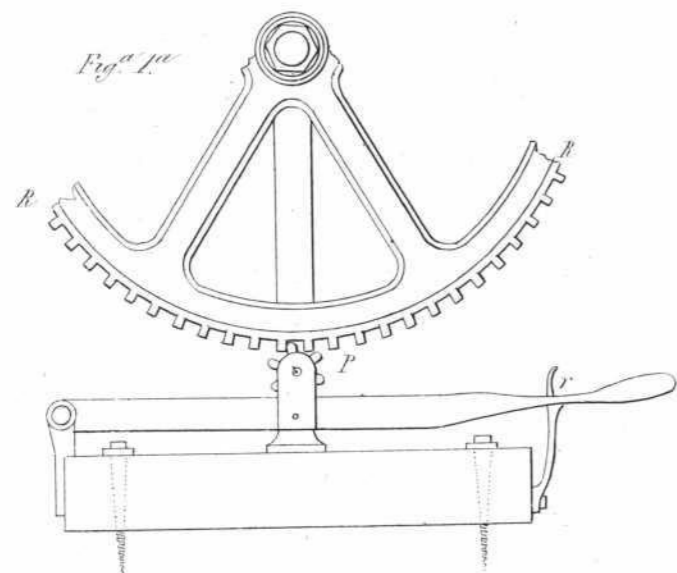
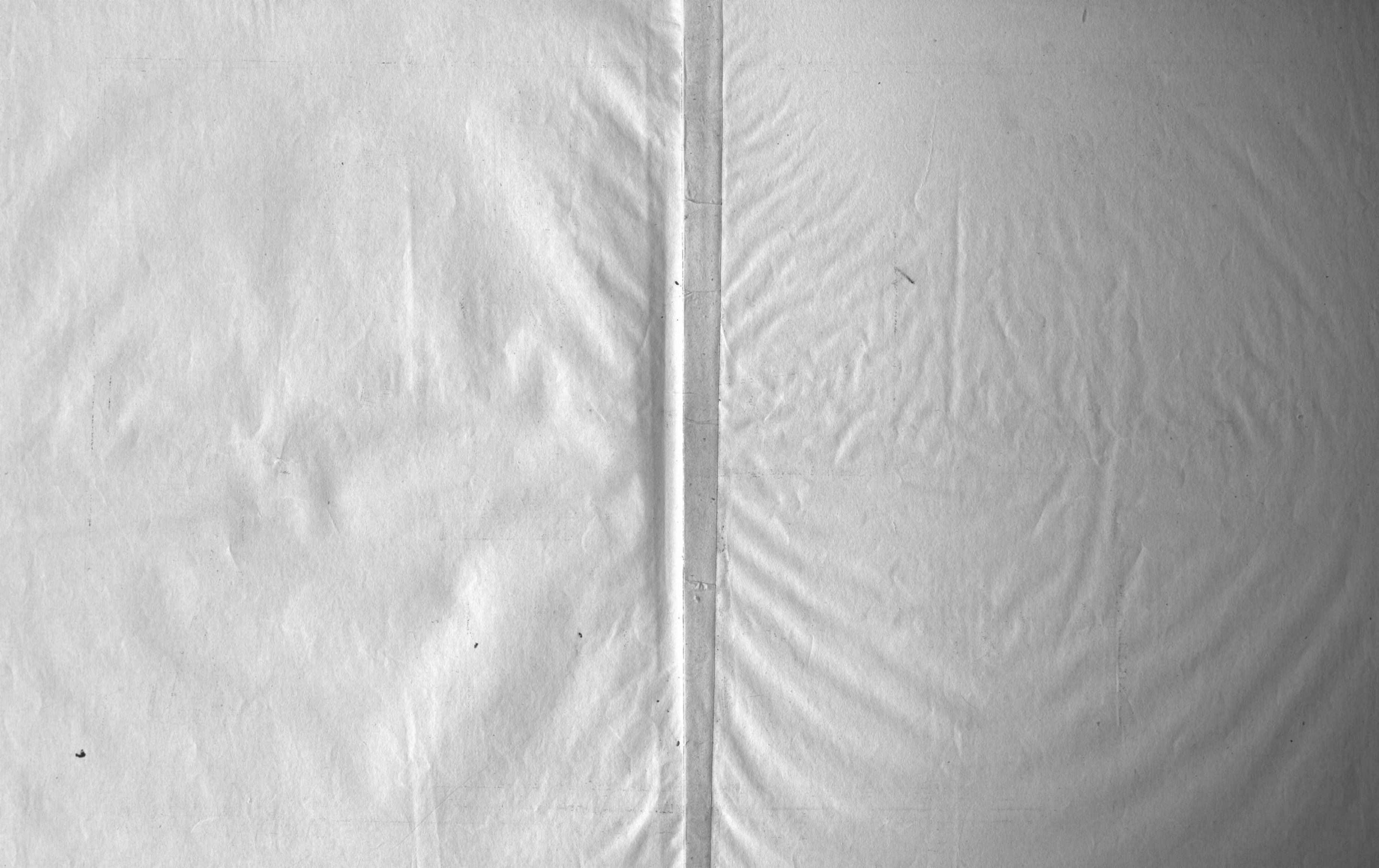


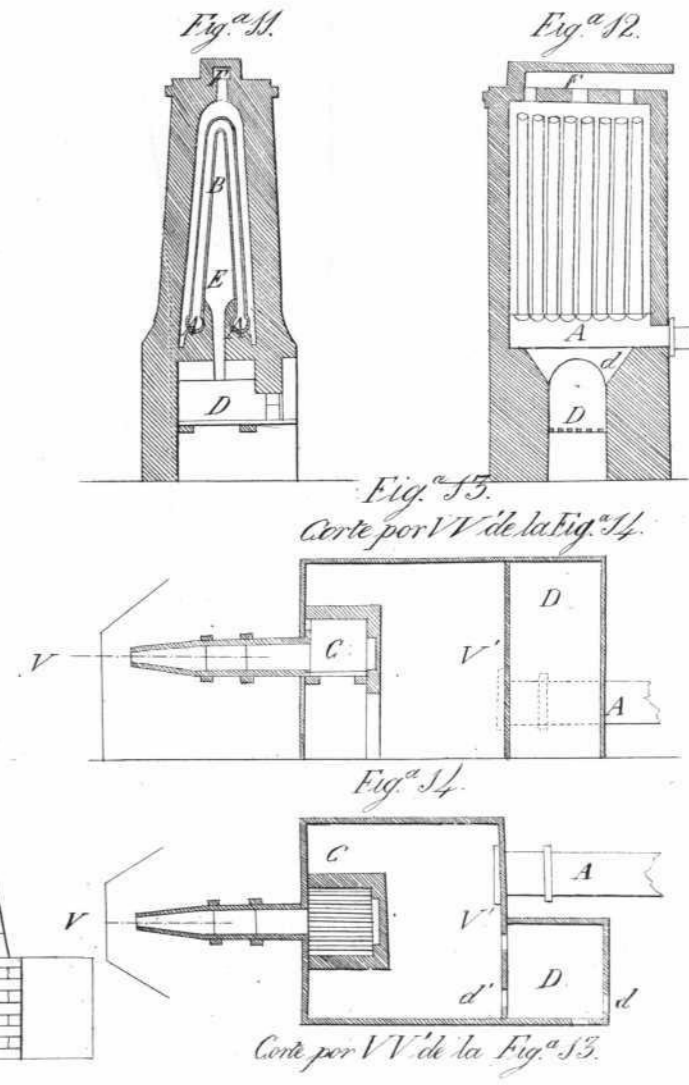
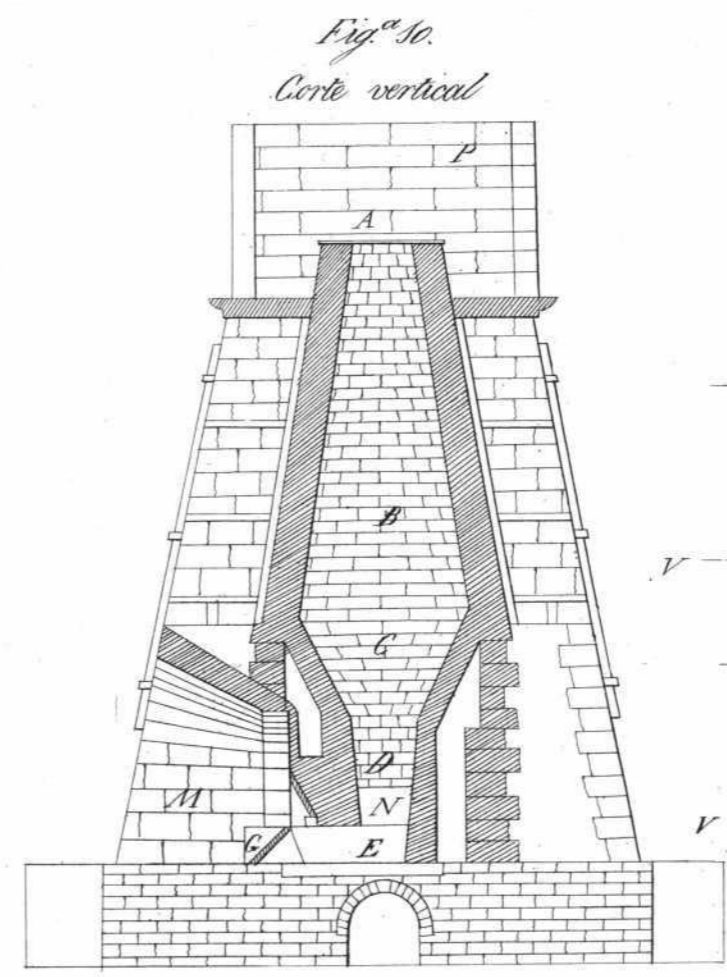
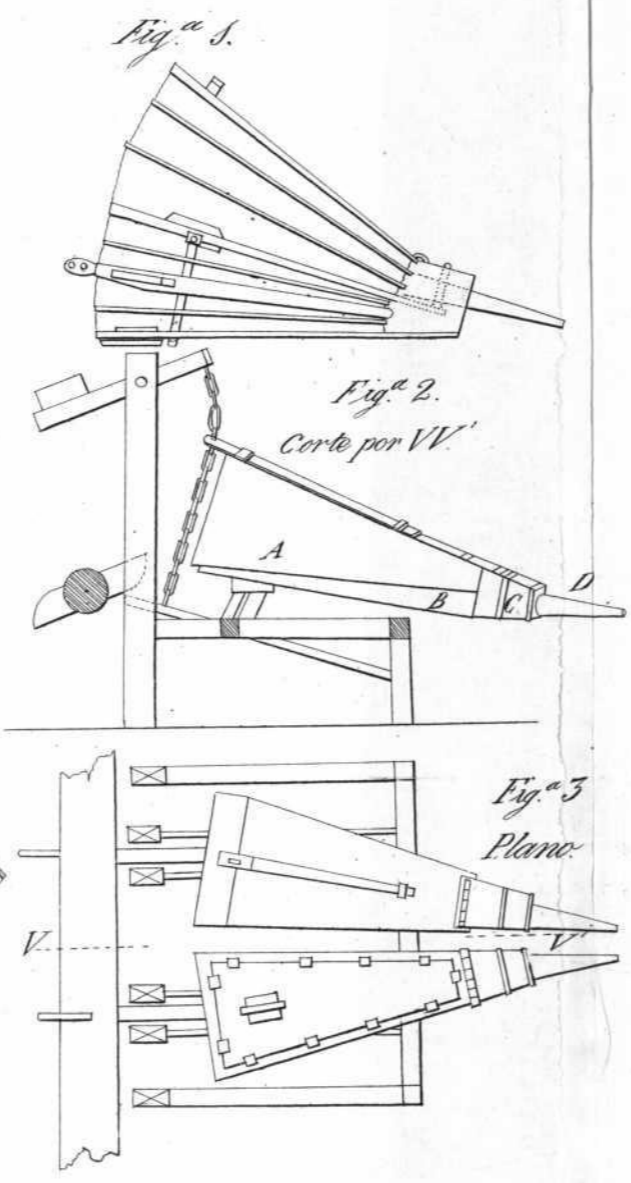
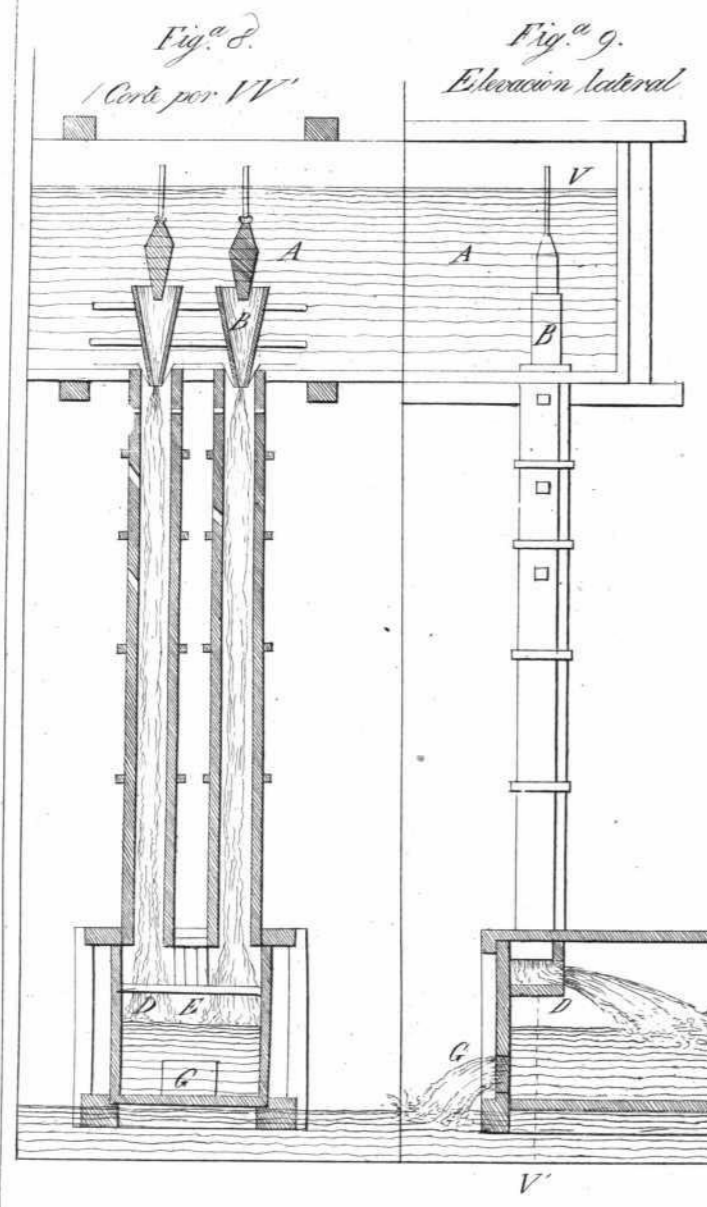
Fig. 7.



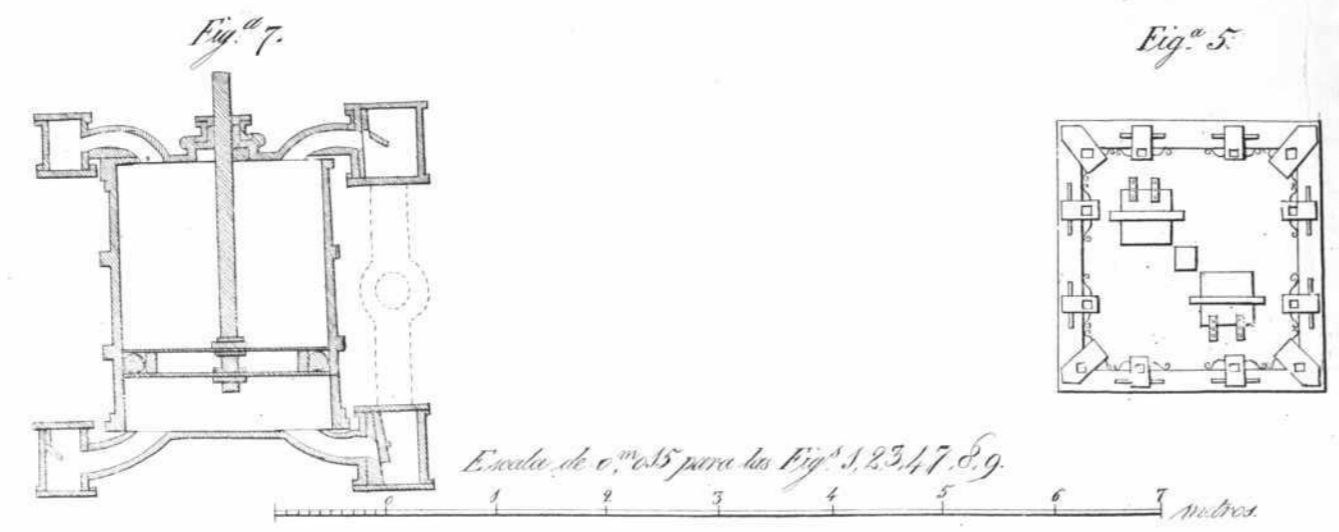




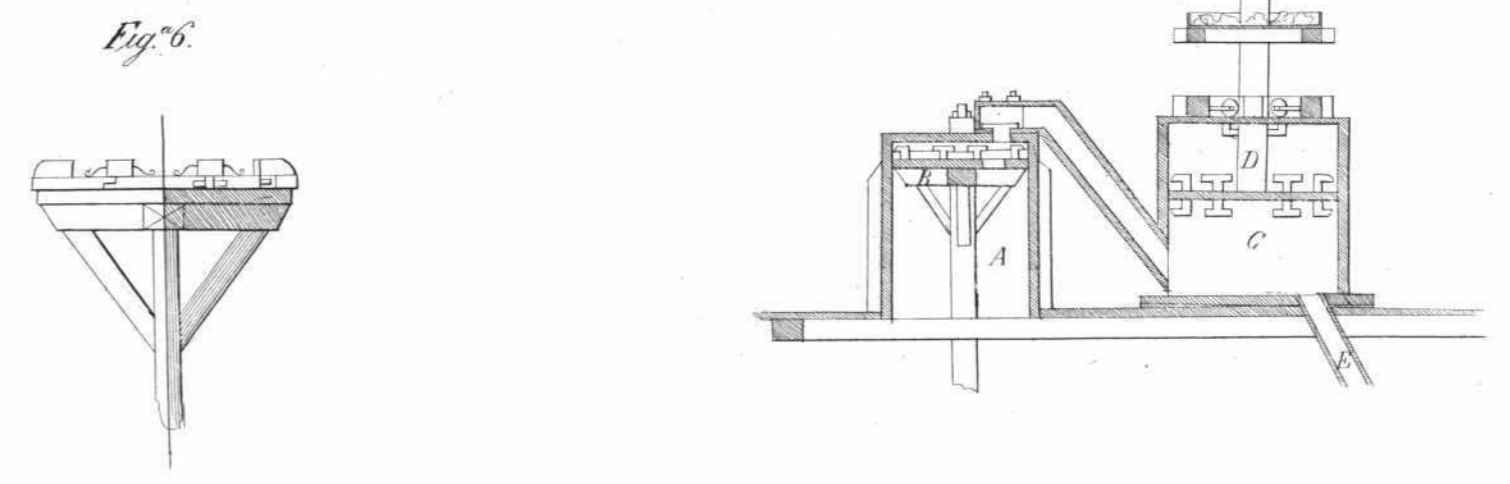




Escala de 0.^m al p.^o las Fig.^a 10, 11, 12, 13, y 14.



Escala de 0.^m al 5 para las Fig.^a 7, 5, 17, 8, y 9.





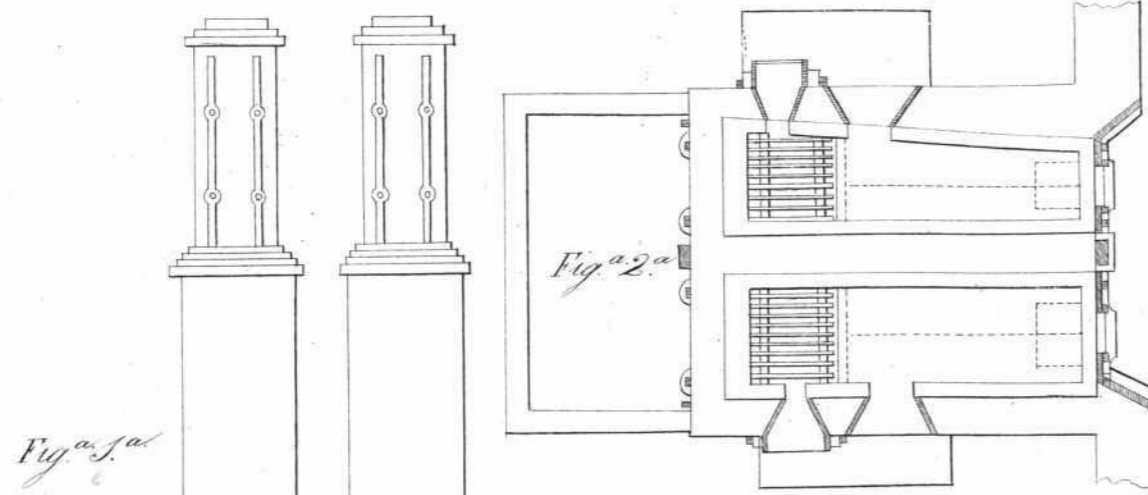


Fig. 1a

Fig. 2a

Figuras 1, 2, y 3, horno de Laja

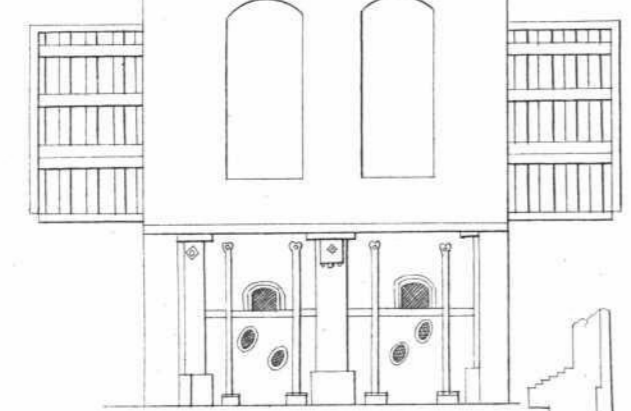


Fig. 3a

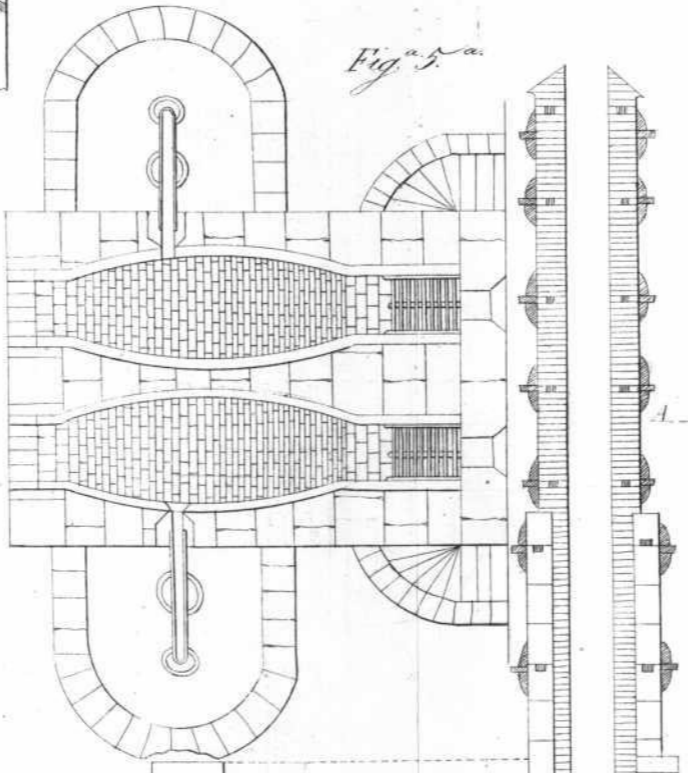


Fig. 4a

Fig. 5a

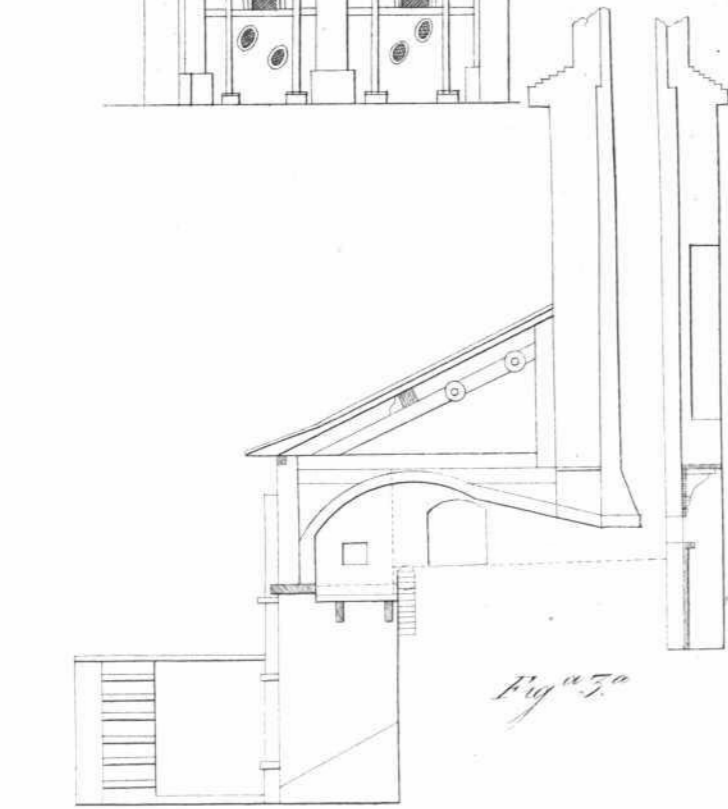


Fig. 6a

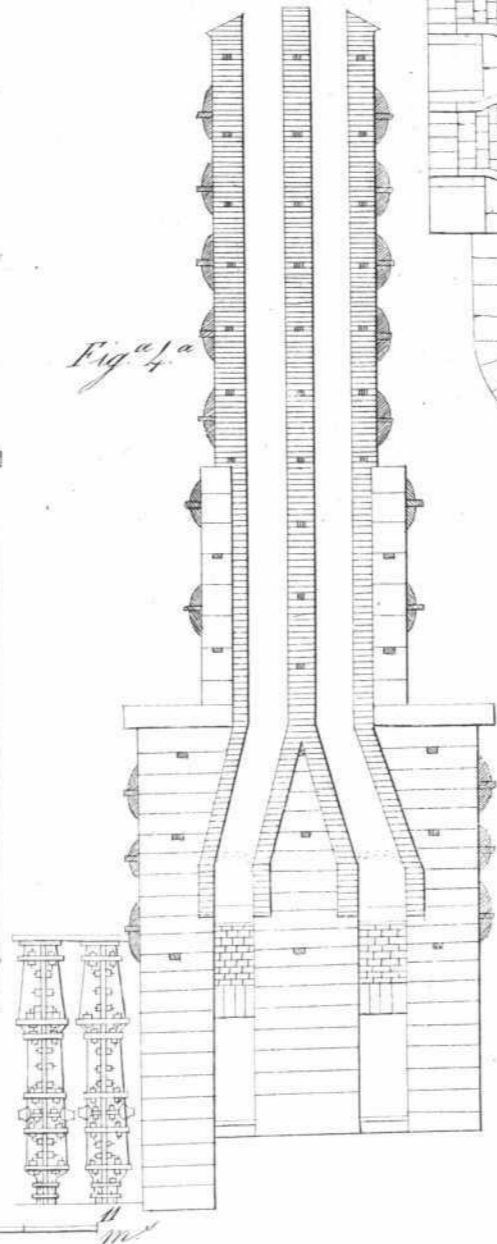


Fig. 7a

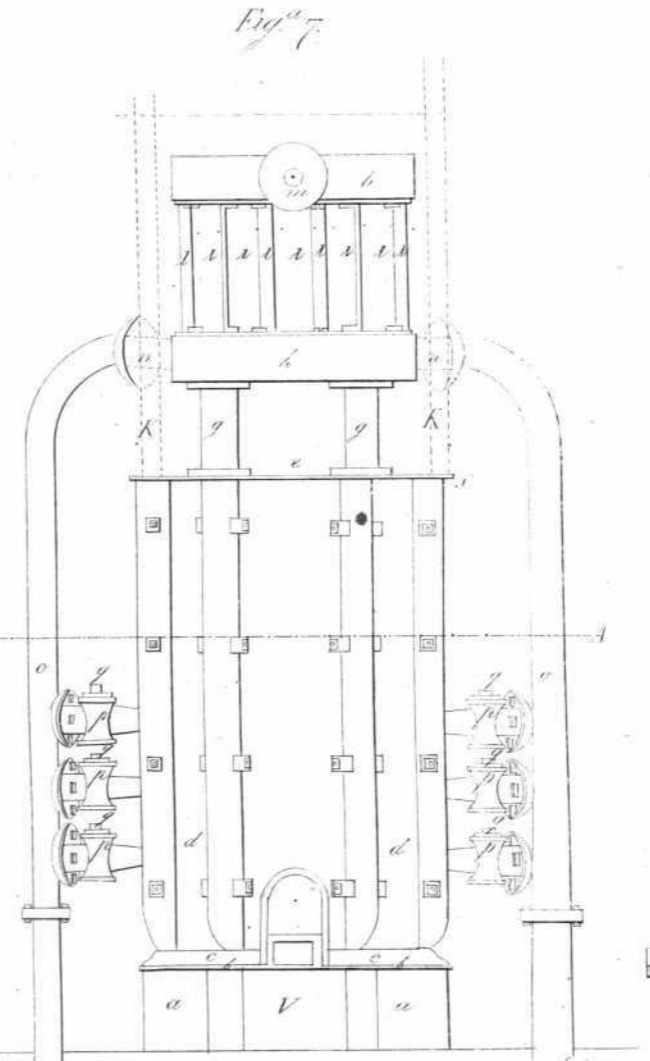


Fig. 8a

Fig. 8a

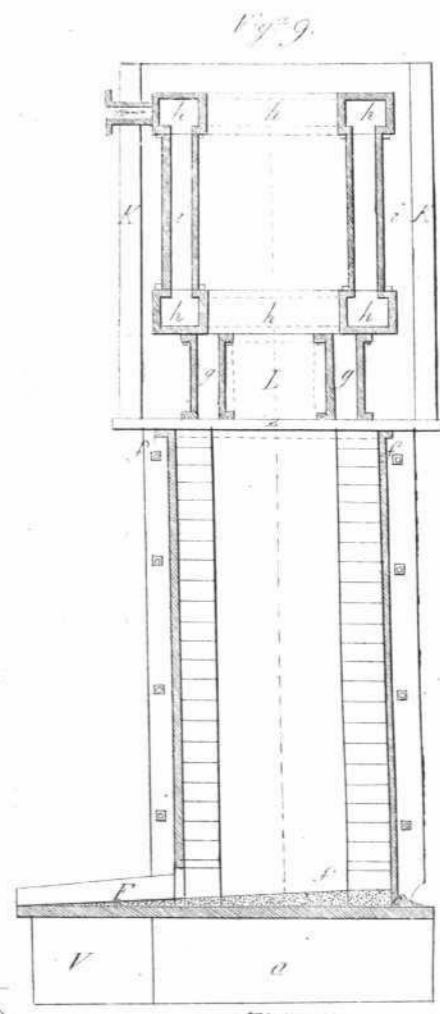
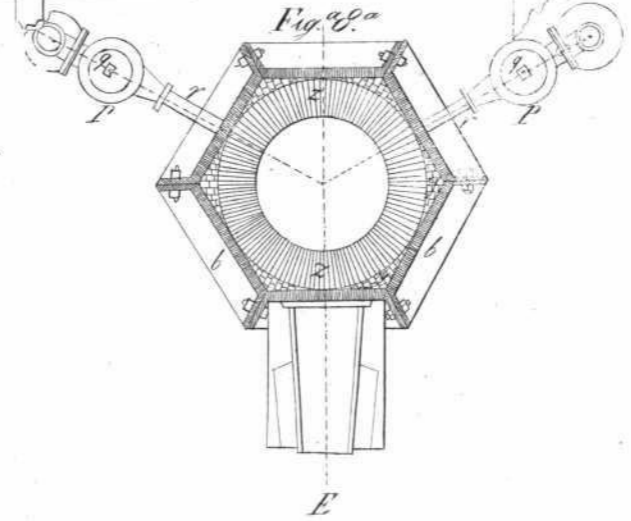


Fig. 9a

Fig. 9a



E

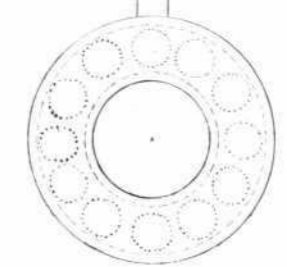
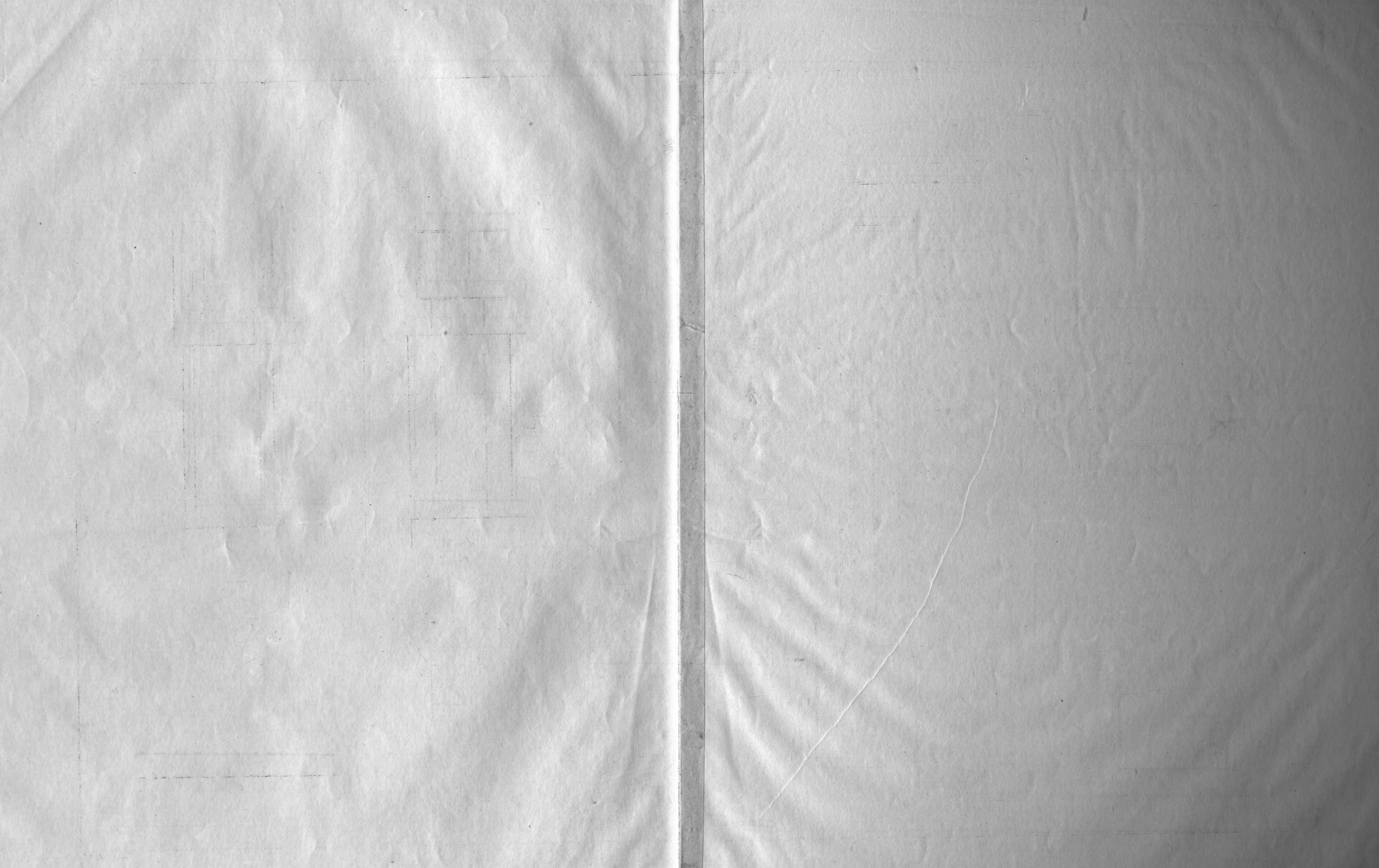


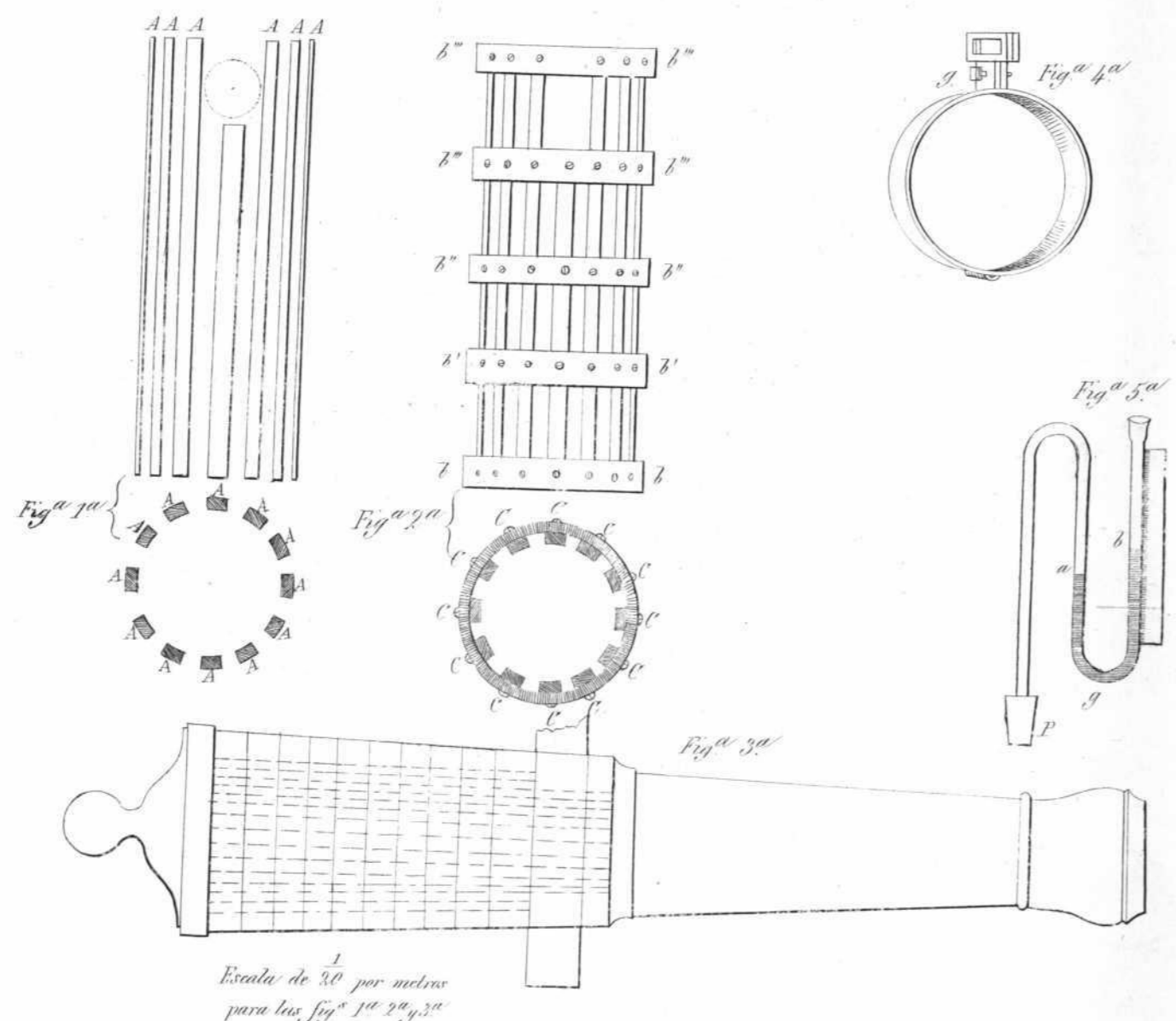
Fig. 11a

0 1 2 3 pies por metro

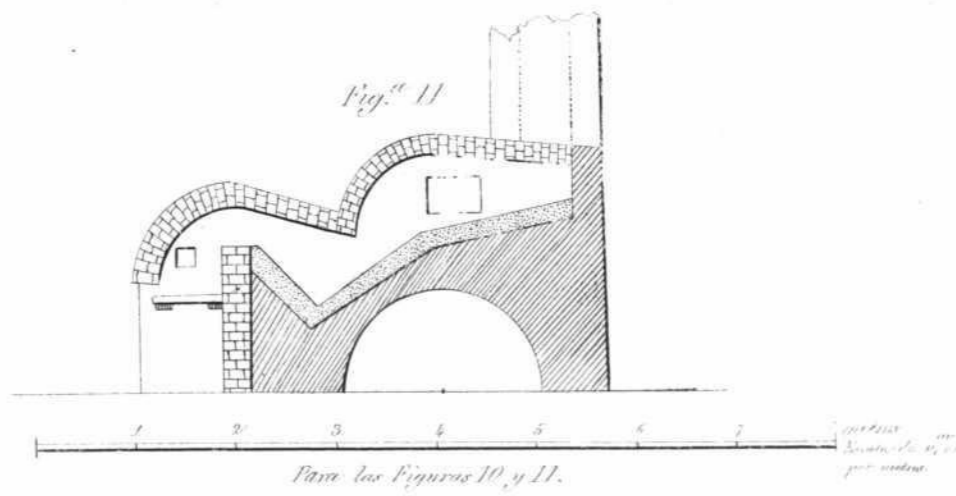
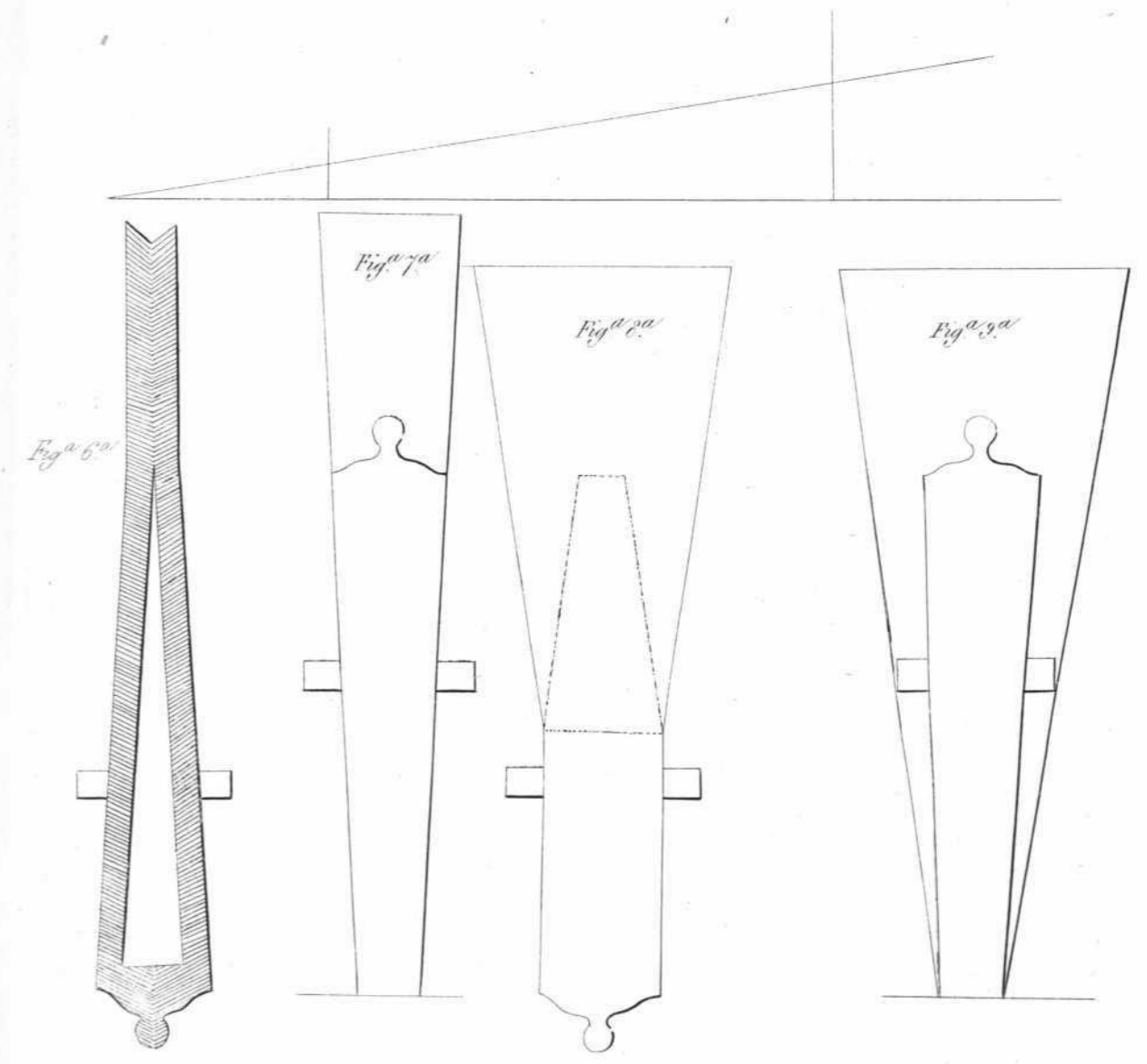
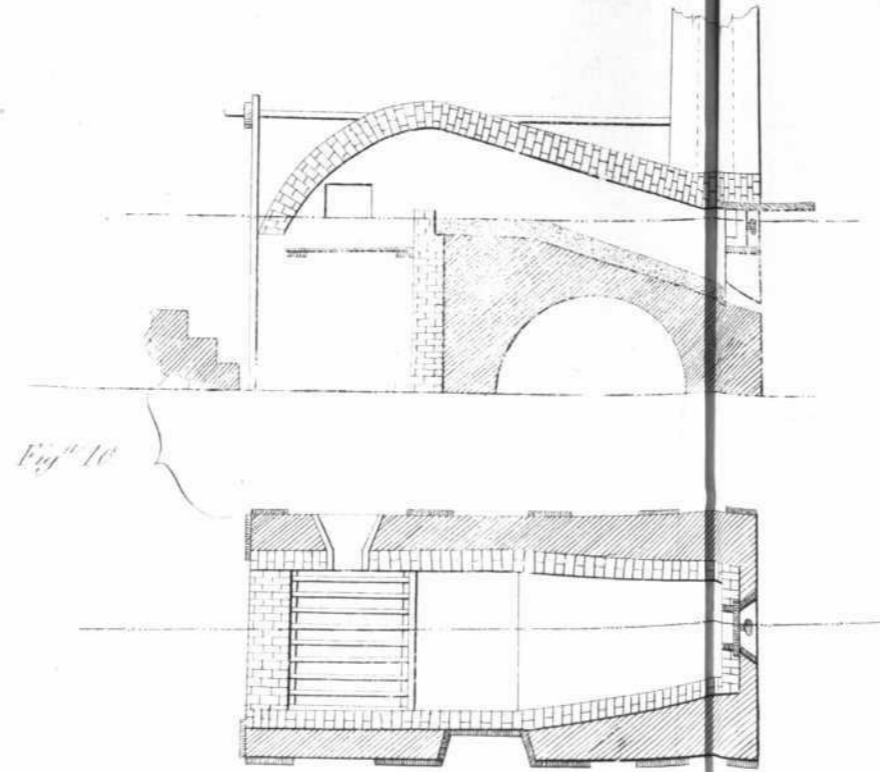
0 1 2 3 pies

Escala de $\frac{1}{50}$ del natural.

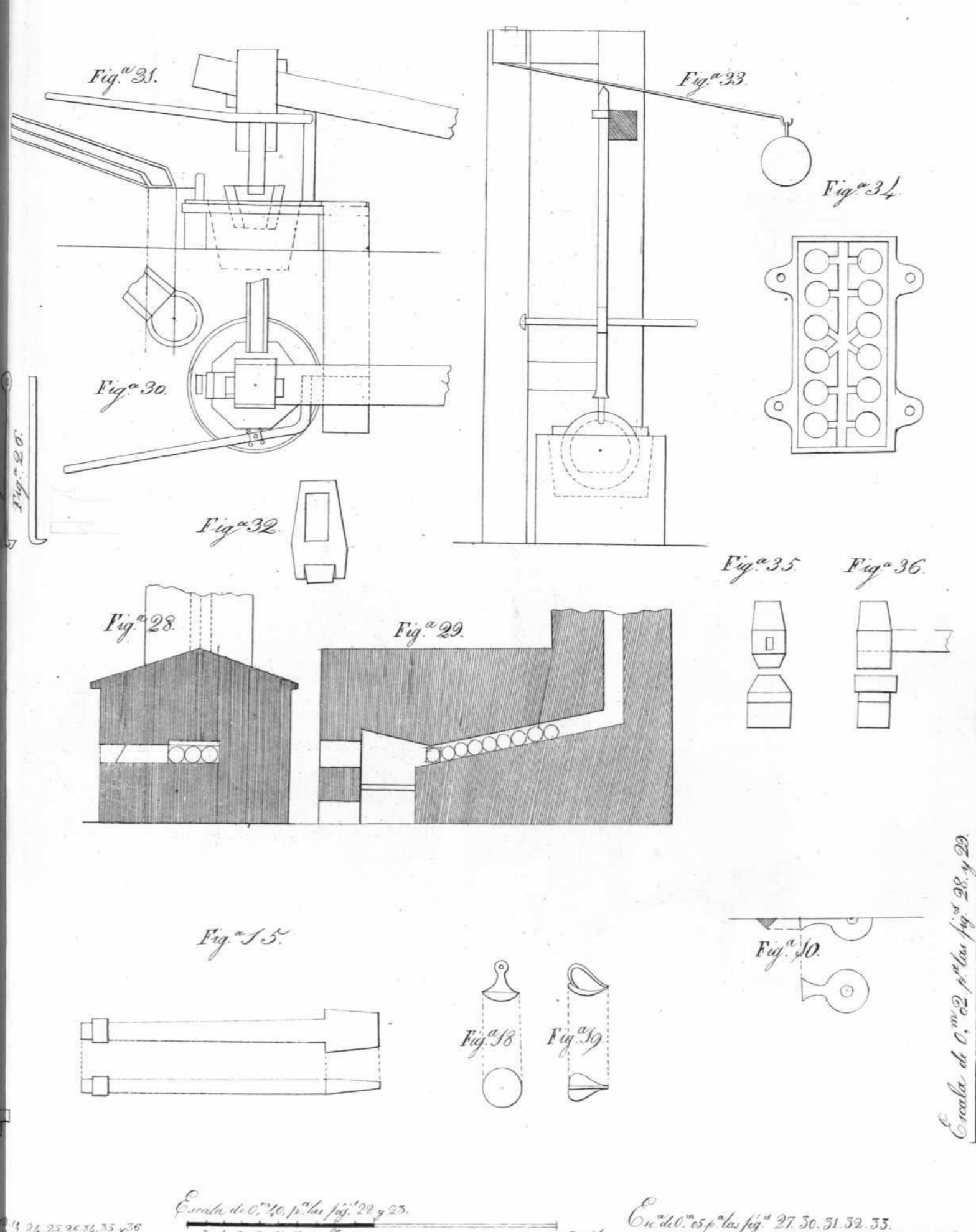
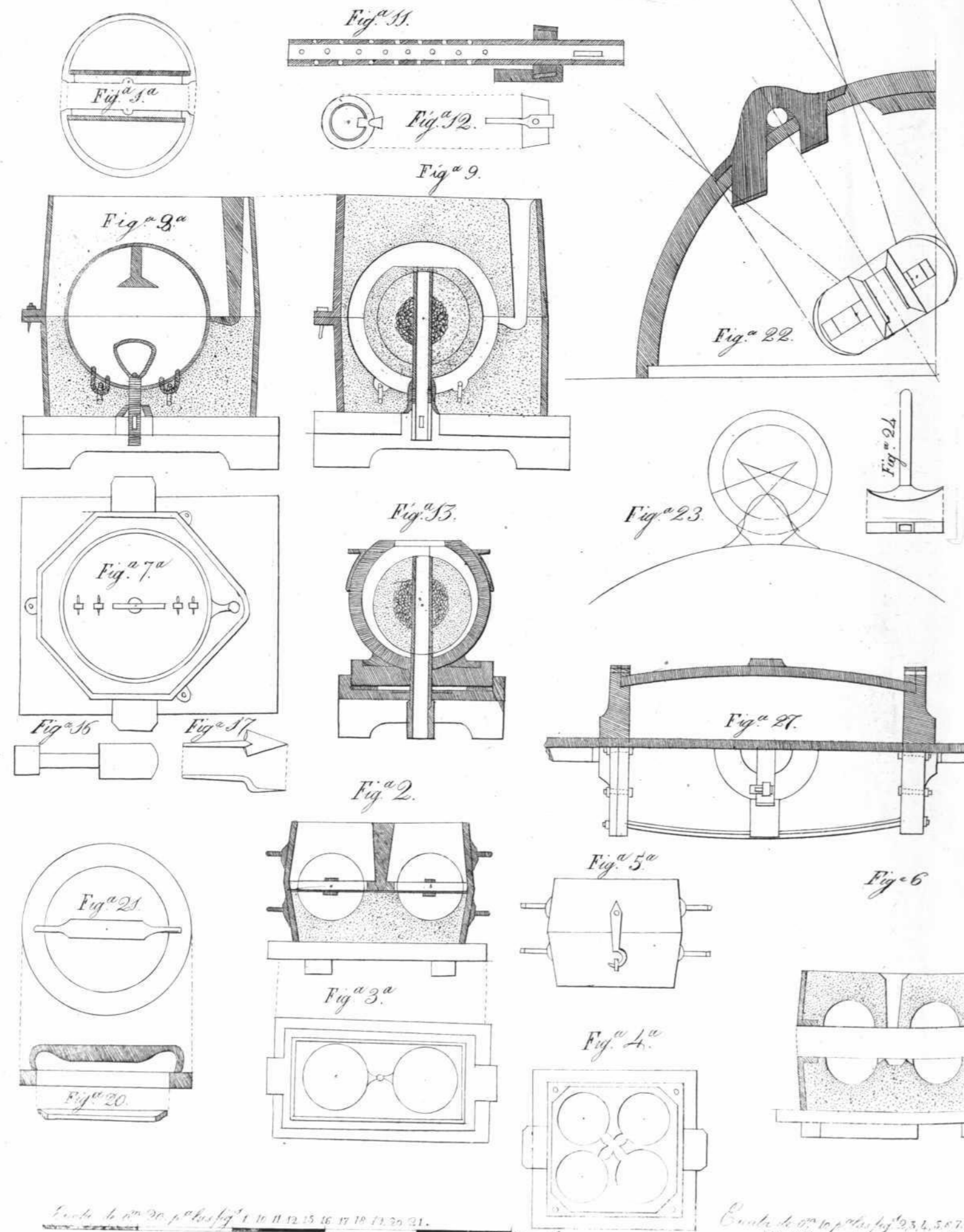




Escala de $\frac{1}{30}$ por metros para las fig^s 1^a, 2^a, y 3^a







Escala de 0.^m 20 p.^{ta} las fig.^s 1, 11, 12, 13, 16, 17, 18, 19, 20, 21.

Escala de 0.^m 10 p.^{ta} las fig.^s 2, 3, 4, 5, 6, 7, 8, 9, 10, 22, 23, 24, 25, 26, 27, 28, 29, 30, 31, 32, 33, 34, 35, 36.

Escala de 0.^m 40 p.^{ta} las fig.^s 22 y 25.

Escala de 0.^m 05 p.^{ta} las fig.^s 27, 30, 31, 32, 33.

Escala de 0.^m 02 p.^{ta} las fig.^s 28 y 29.

Elaborado de Arce.

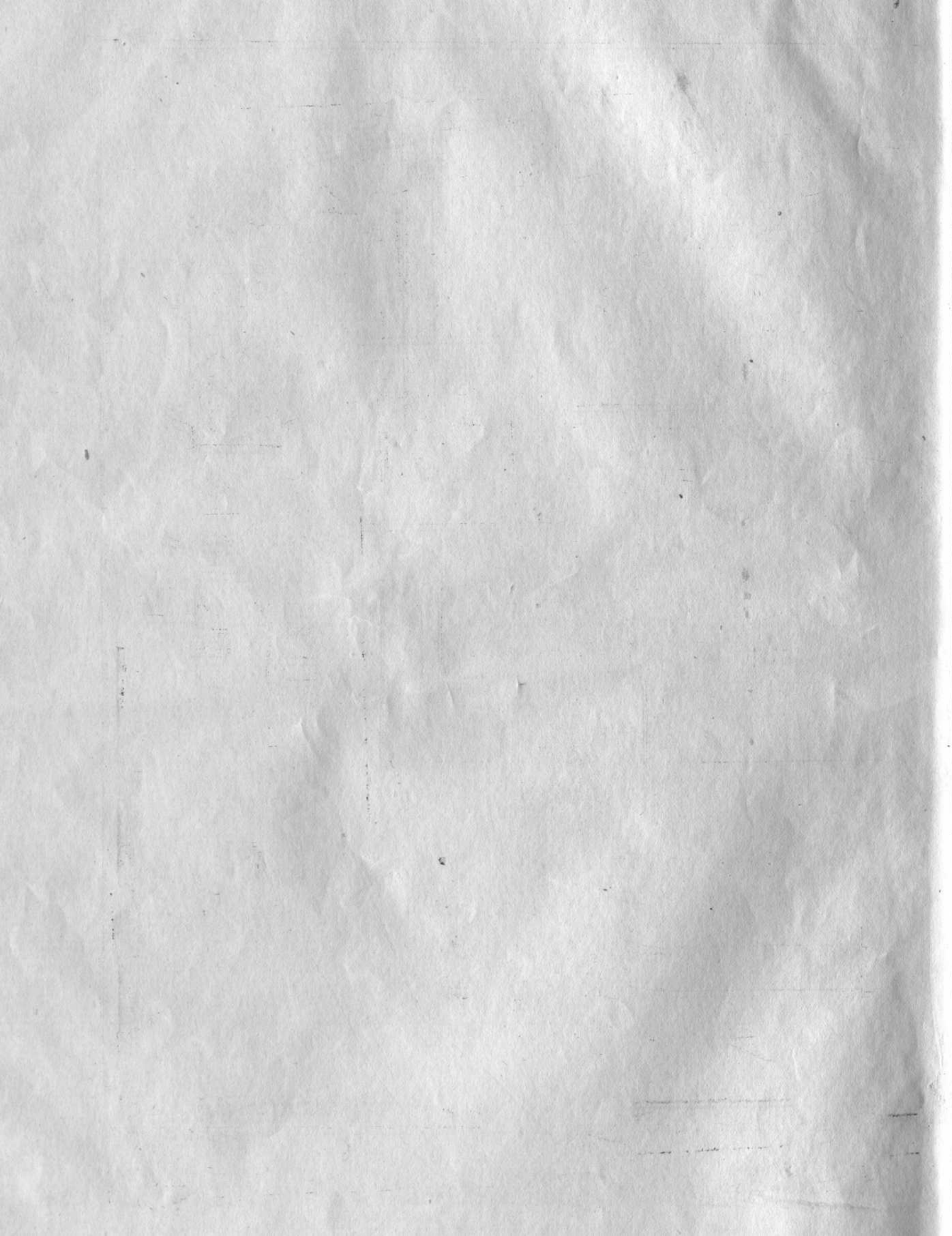


Fig. 3.

Fig. 4.

Fig. 1.

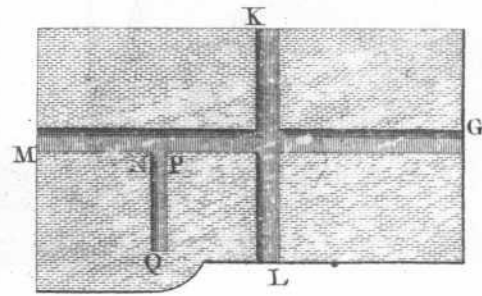
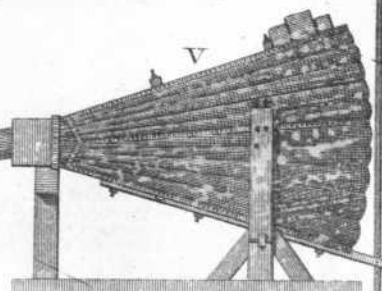
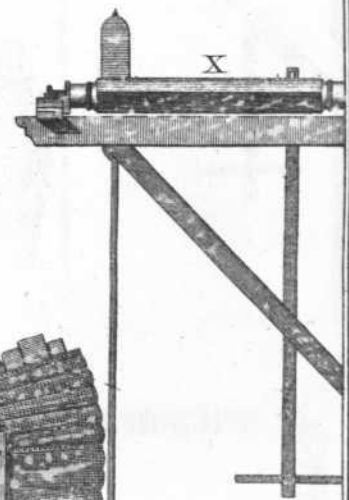
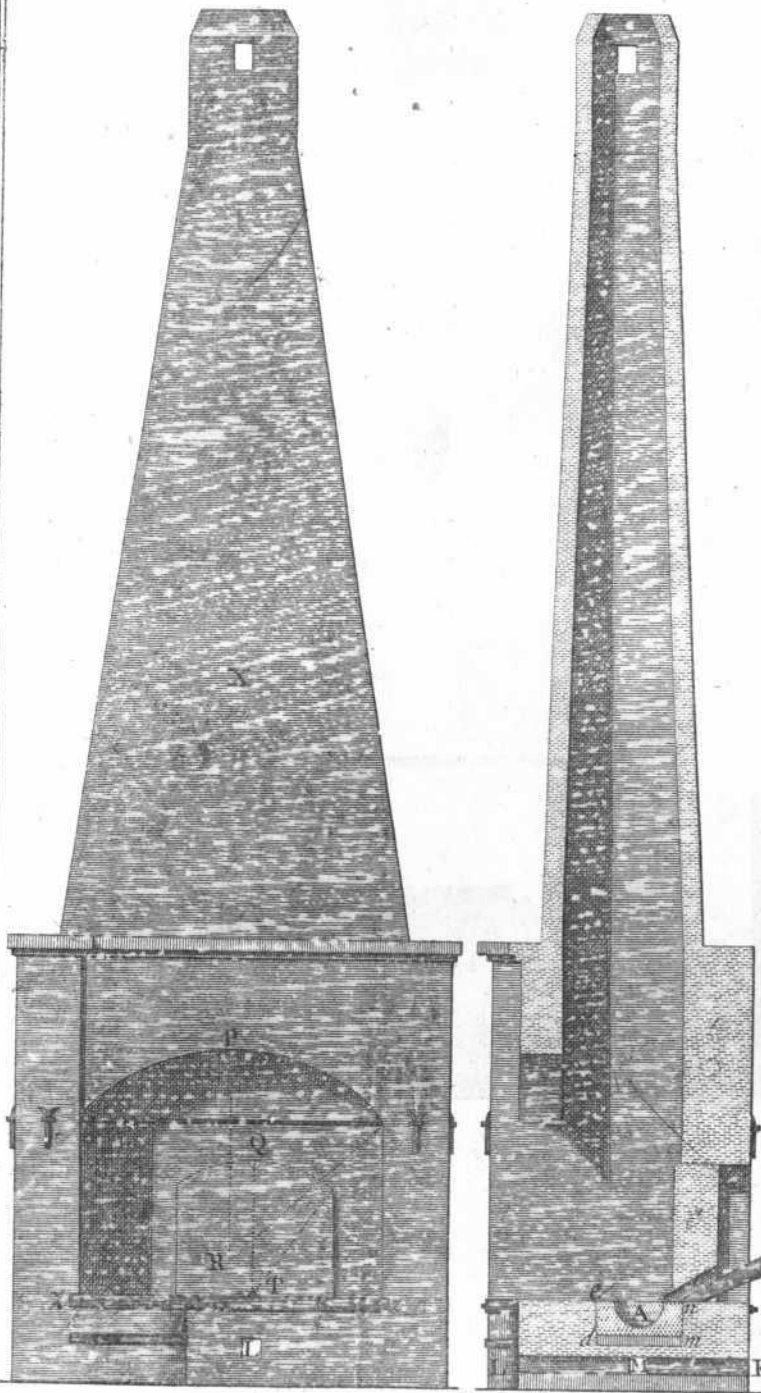
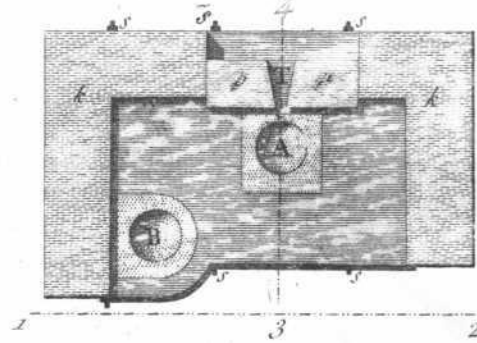


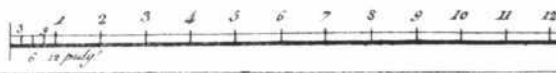
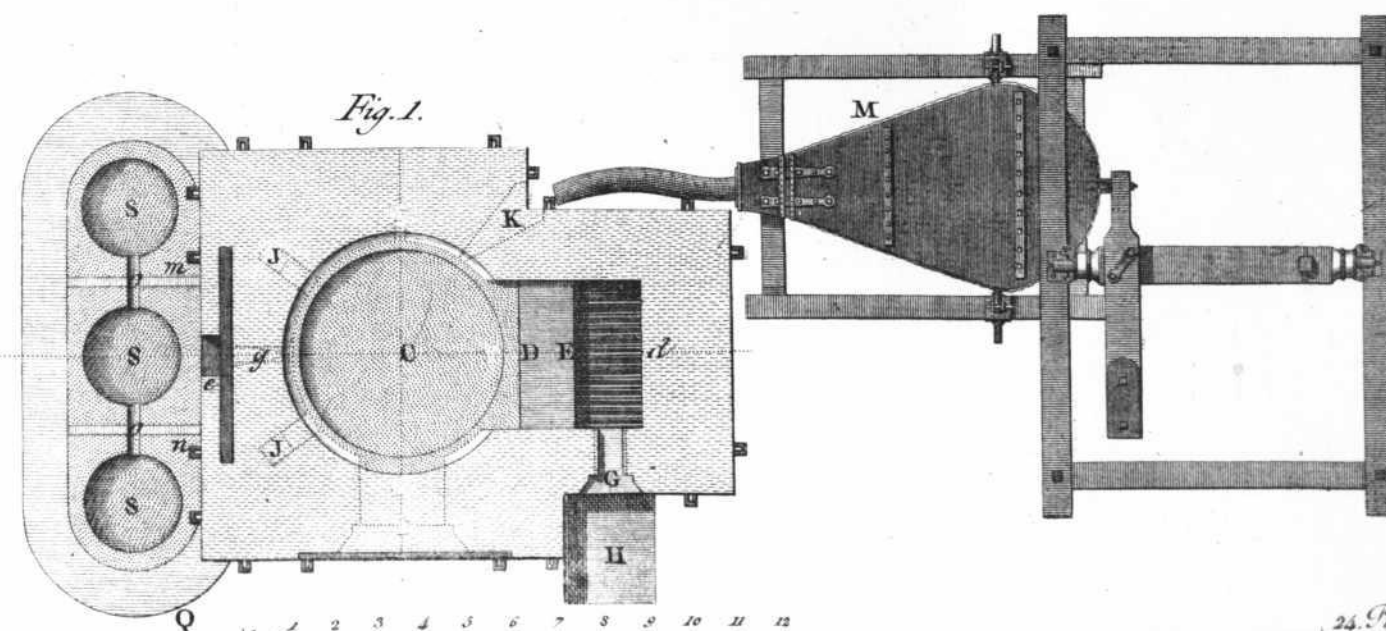
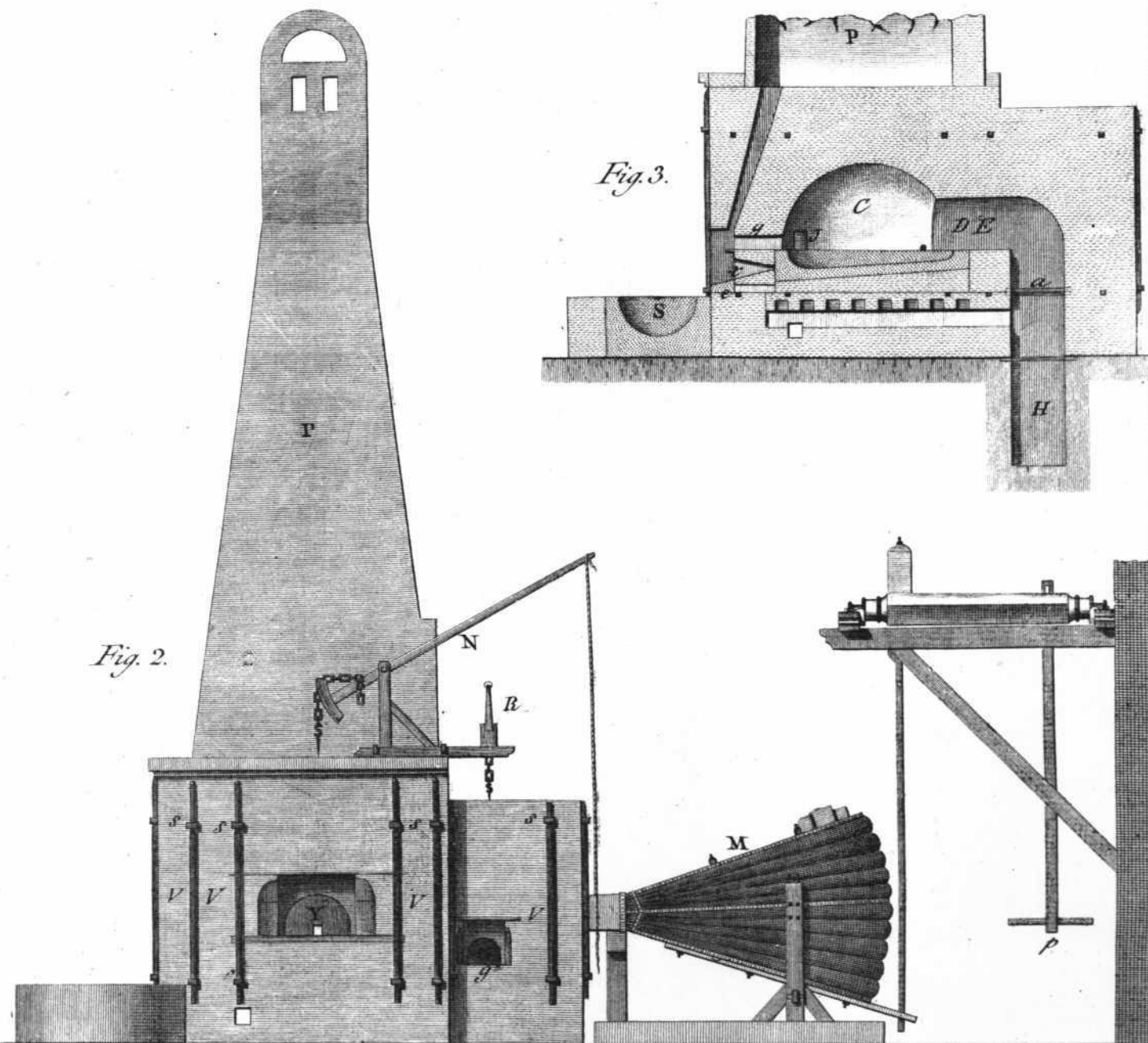
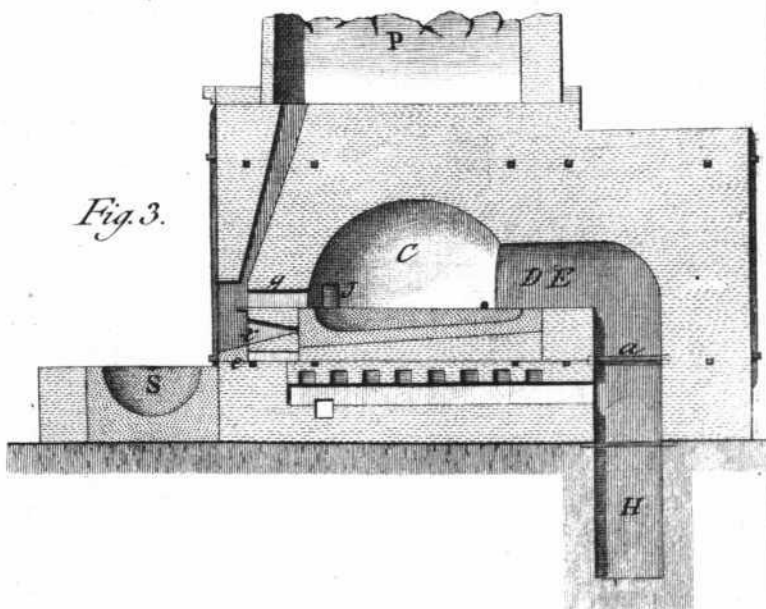
Fig. 2.



1 2 3 4 5 6 7 8 9 10 11 12
35.02 pulgadas

24. Pies de Paris

Renovada esta lamina p' haberse de la primitiva se le han puesto las letras que expresan el cuaderno de la explicacion



24. Pies de Paris.

Fig.^a 2.^a

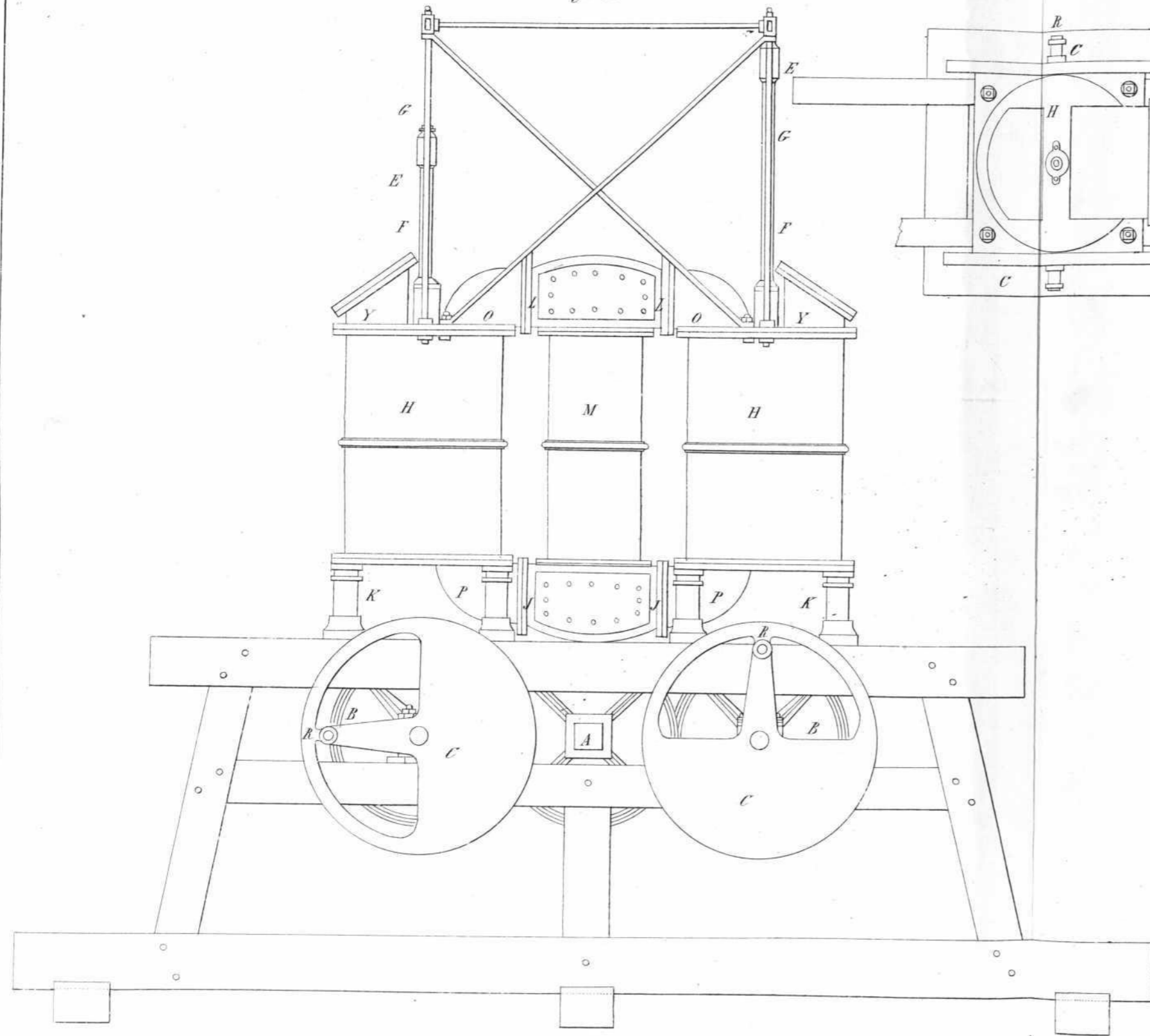


Fig.^a 1.^a

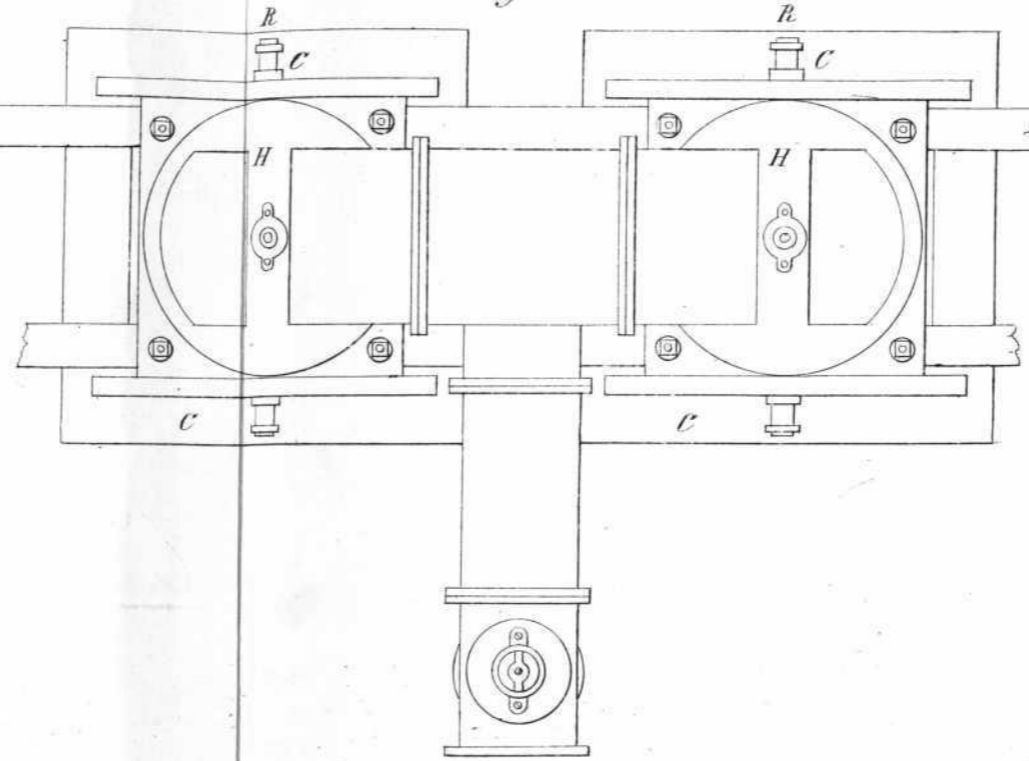
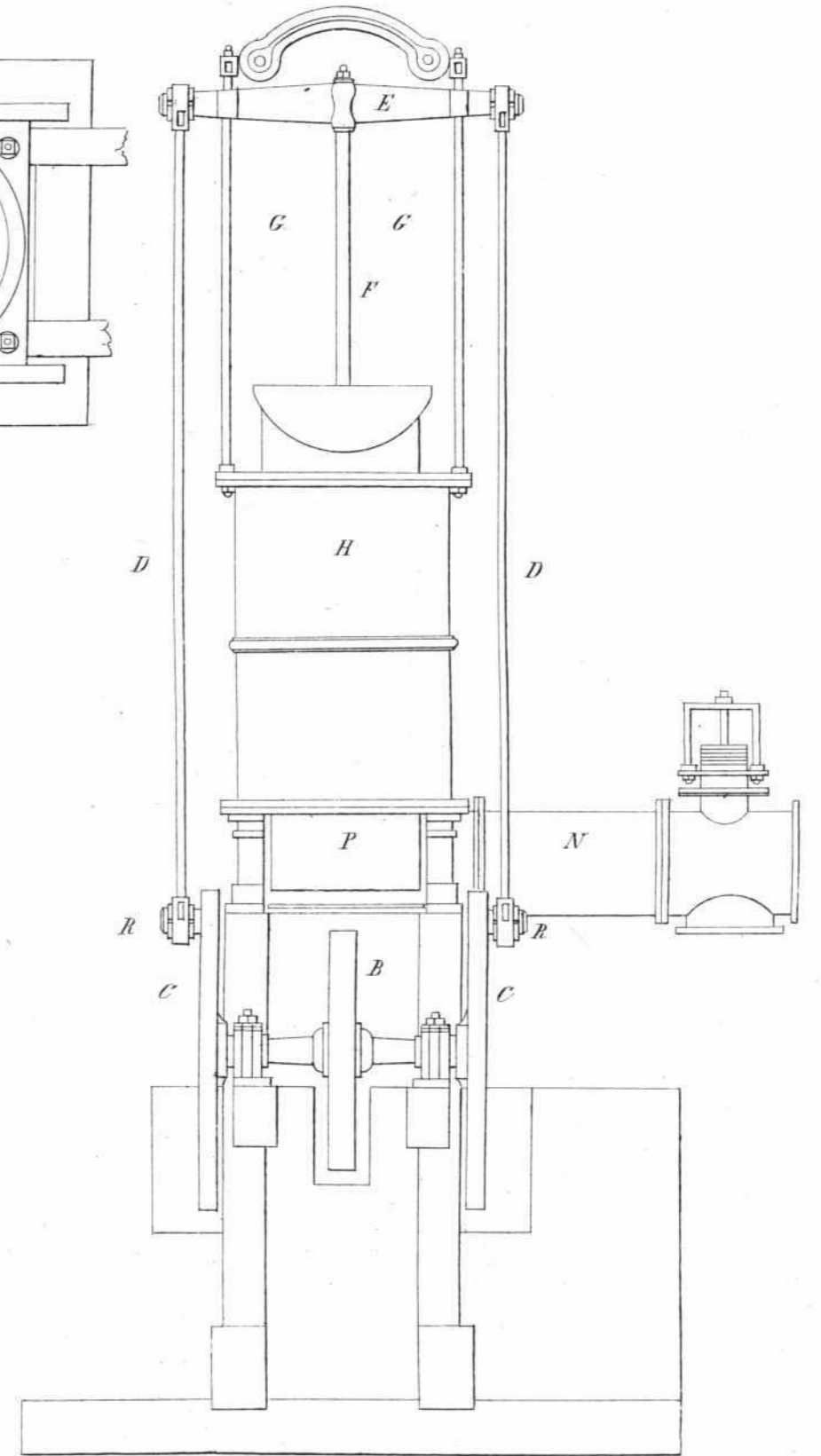
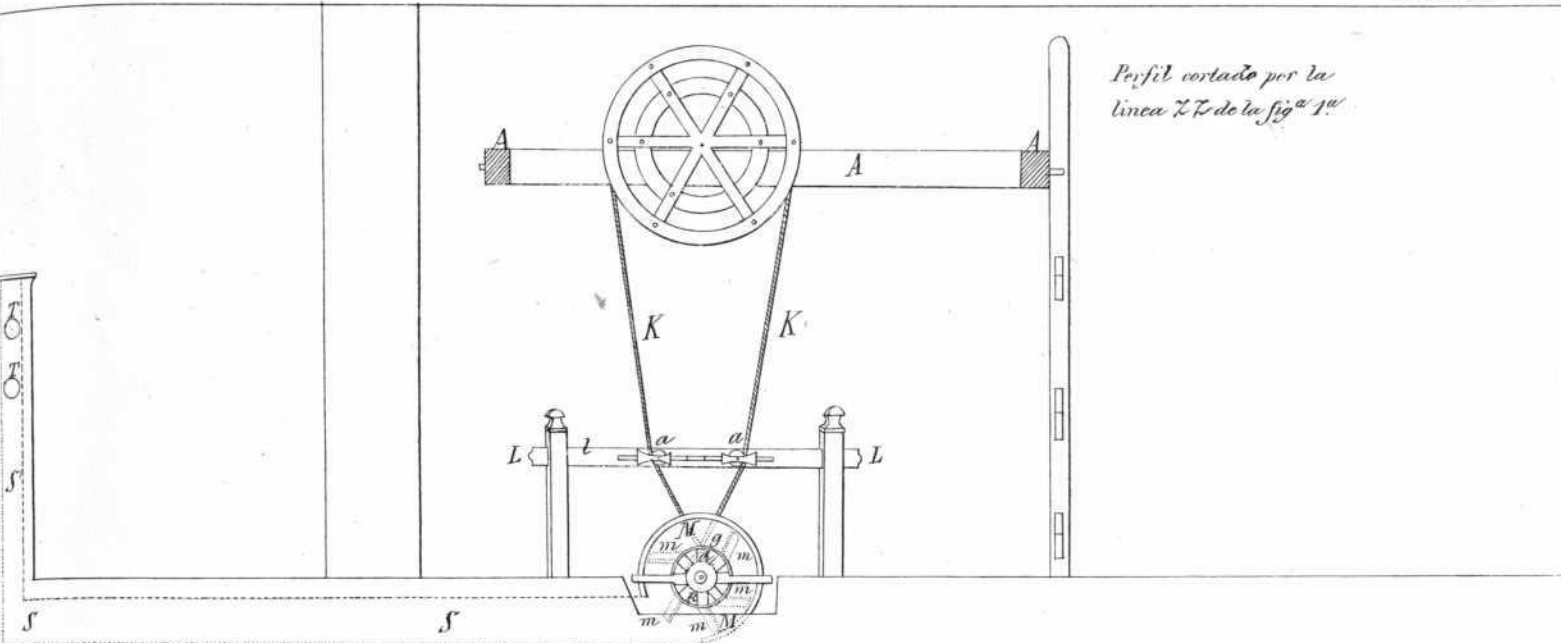
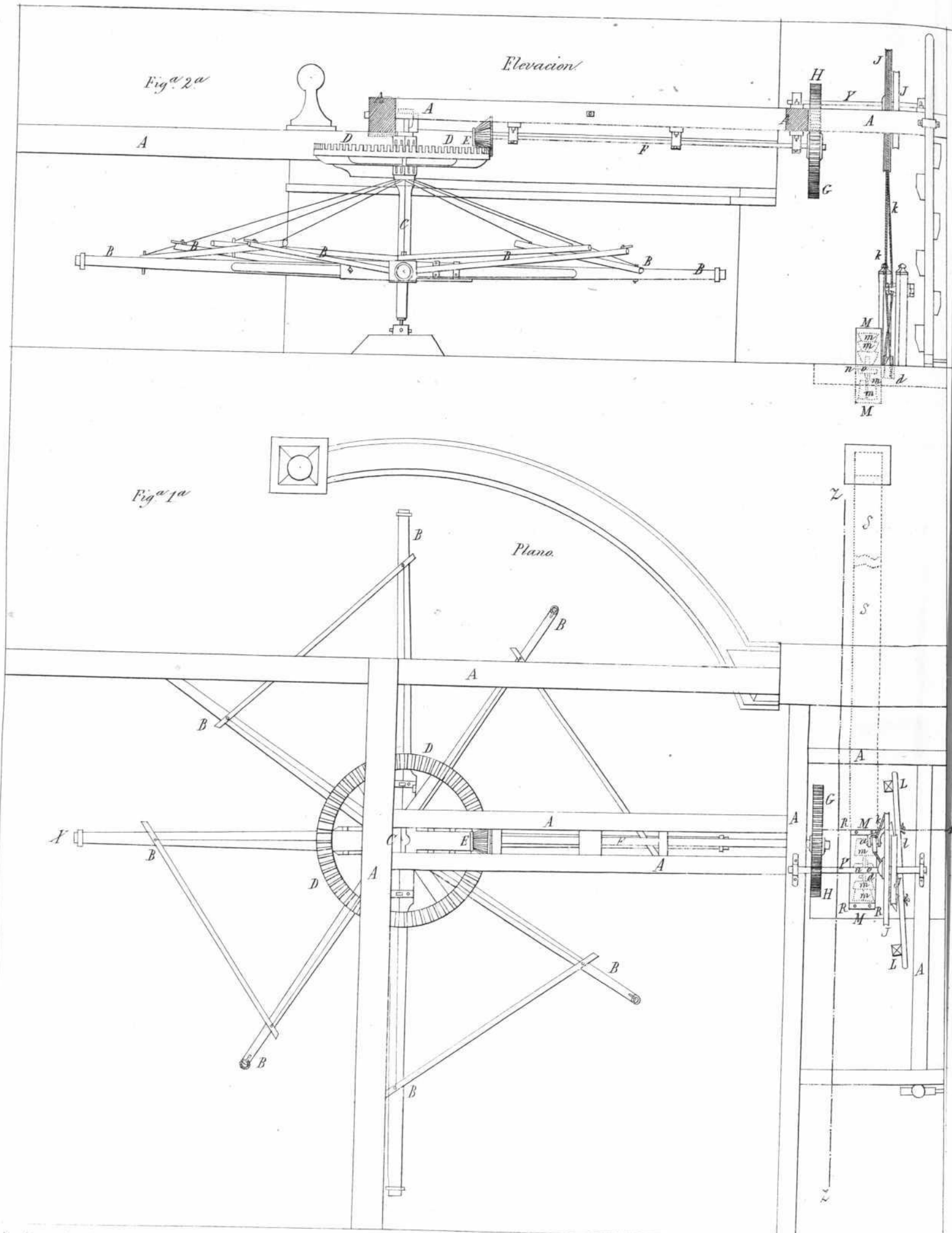


Fig.^a 3.^a



0 1 2 3 4 5 6 7 8 9 10 11 12 13 14 15 pies de Castilla

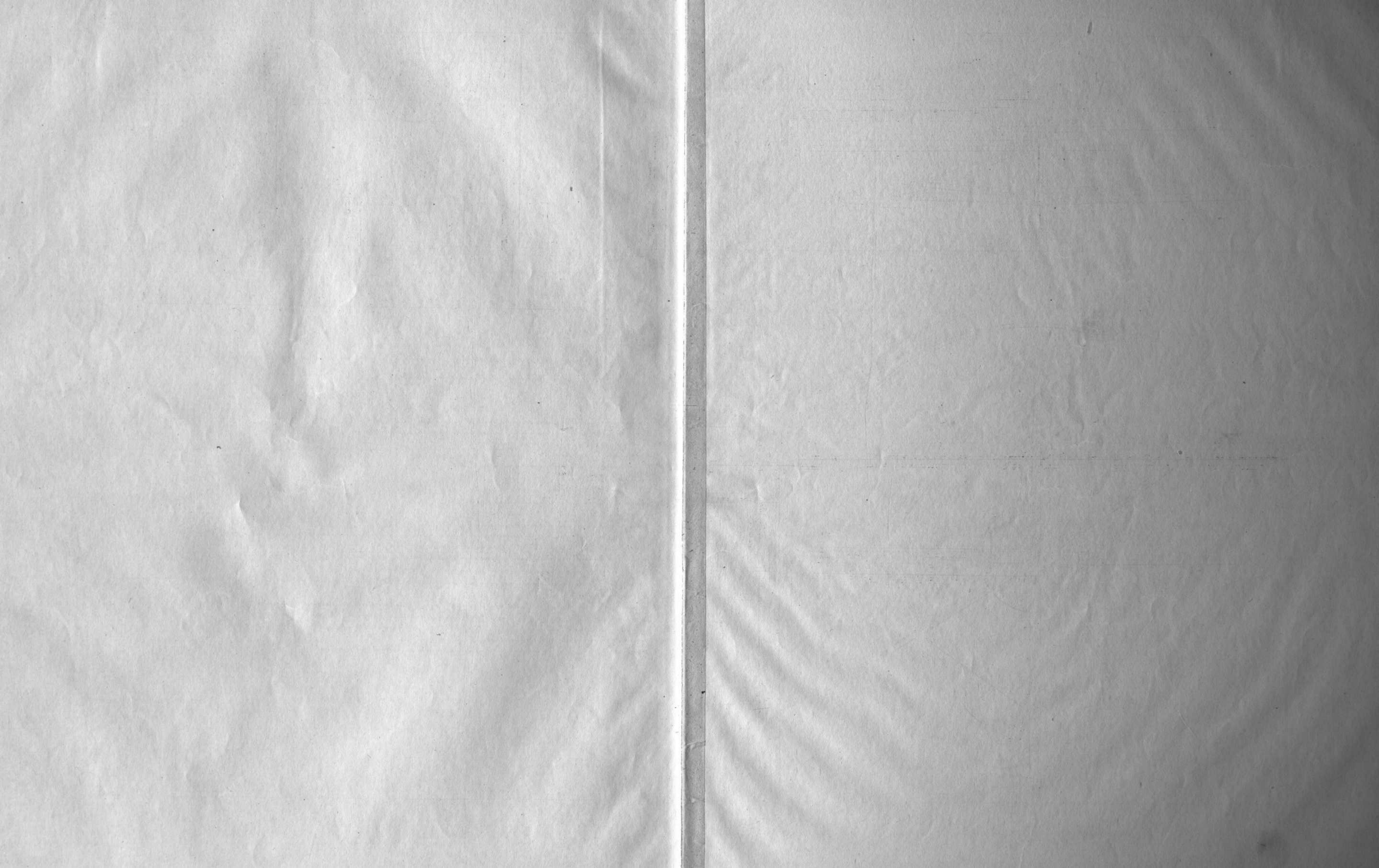




Maquina de viento para los hornos cubiletos en que se fundo el hierro, acorda del natural que existe en la fundicion de broncos de Sevilla.

Explicacion

- A: armazon de madera ó vigas necesarias para el sostenimiento de la maquina.
- B: idem de varas, en el cual se colocan las caballerias que dan movimiento á esta.
- C: árbol que sirve de eje á la rueda dentada D.
- D: rueda dentada de 112 dientes.
- E: linterna de 15 dientes que es movida por la rueda D.
- F: eje comun á la linterna E y á la rueda G.
- G: rueda de 108 dientes á la qual comunica el movimiento la linterna E.
- H: segunda linterna de 15 dientes movida por la rueda G.
- I: eje comun á la linterna H y á las ruedas J.
- J: ruedas holgadas que siguen el mismo movimiento que la linterna H.
- K: cuerda sin fin que encajando en la rueda holgada J pasan sus dos extremos por las dos ruedecitas a y cruzandose en el punto g, vuelven á encajar en otra rueda igualmente holgada que es la marcada con la letra d.
- L: armazon de madera en que se colocan las ruedecitas a, que pueden correrse á la largo del bastido L.
- d: rueda holgada que es movida por la cuerda sin fin, y cuyo eje es el marcado c á la letra n.
- m: sus paletas situadas en el punto o al eje n, y que recien movimiento por medio de la rueda d, recorren todo el eje que se introduce por las aberturas R, y lo impelen en direccion del conducto S.
- M: caja cilindrica de hierro medio enterrada debajo de tierra y que encierra el sistema de paletas m.
- R: aberturas ovaladas abiertas en amb-ros caras de la caja M, que dan entrada al aire.
- S: conducto subterraneo cuadrado por el qual entra el aire que empujan las paletas m.
- S': parte del mismo conducto en direccion vertical.
- T: aberturas circulares en las cuales se colocan dos tubos que terminan dentro del horno de fundicion.



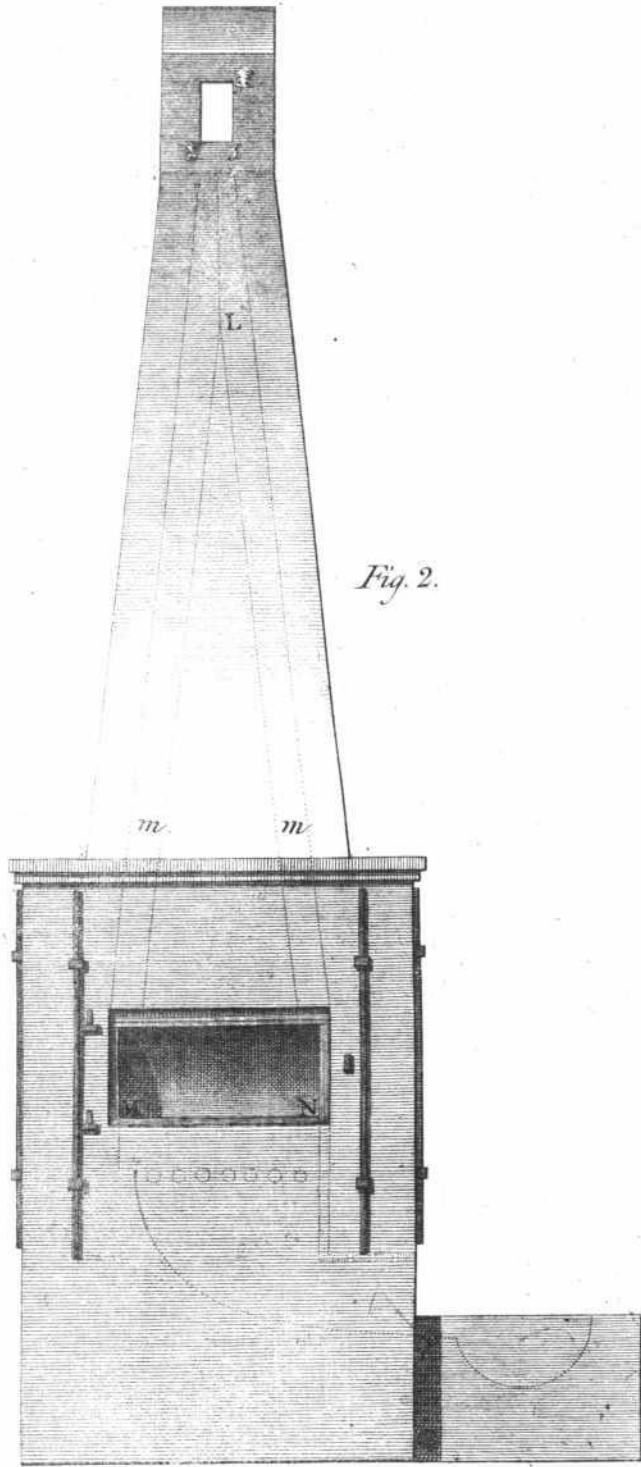


Fig. 2.

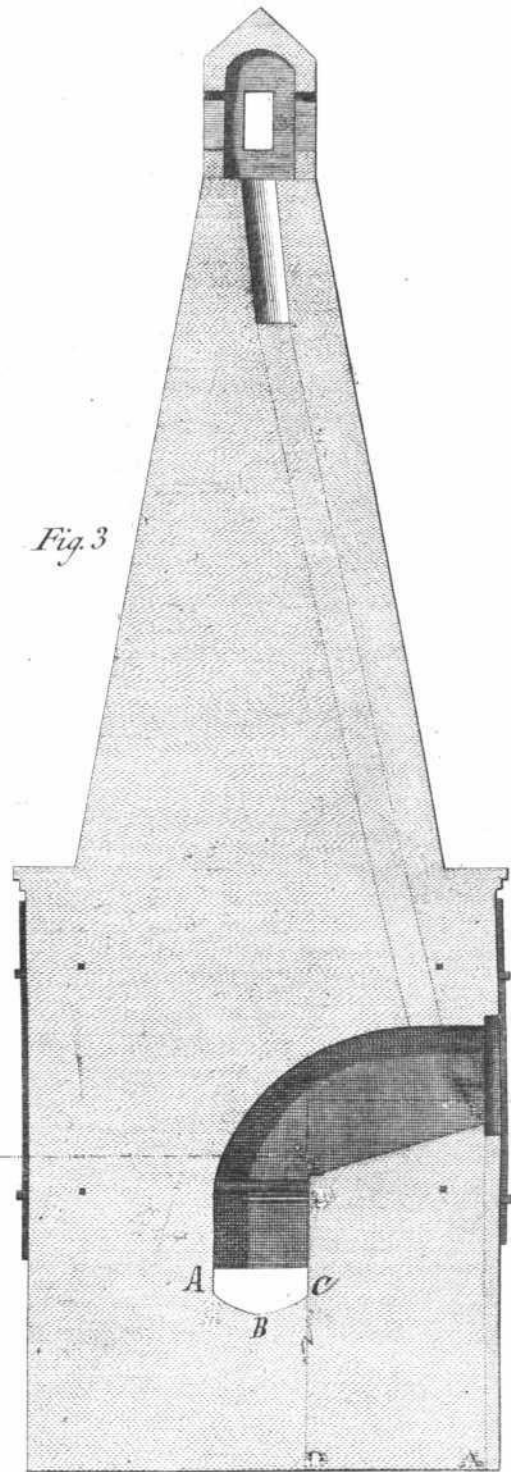


Fig. 3

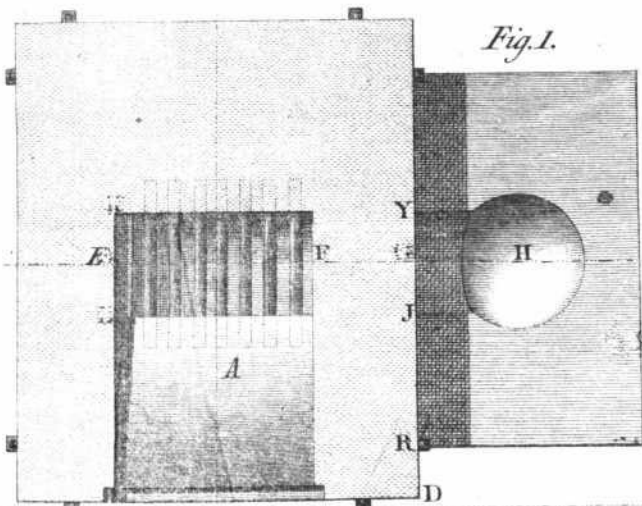


Fig. 1.

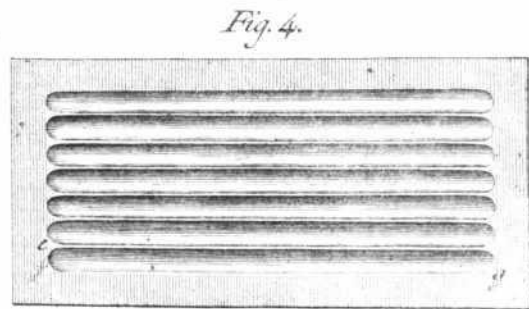
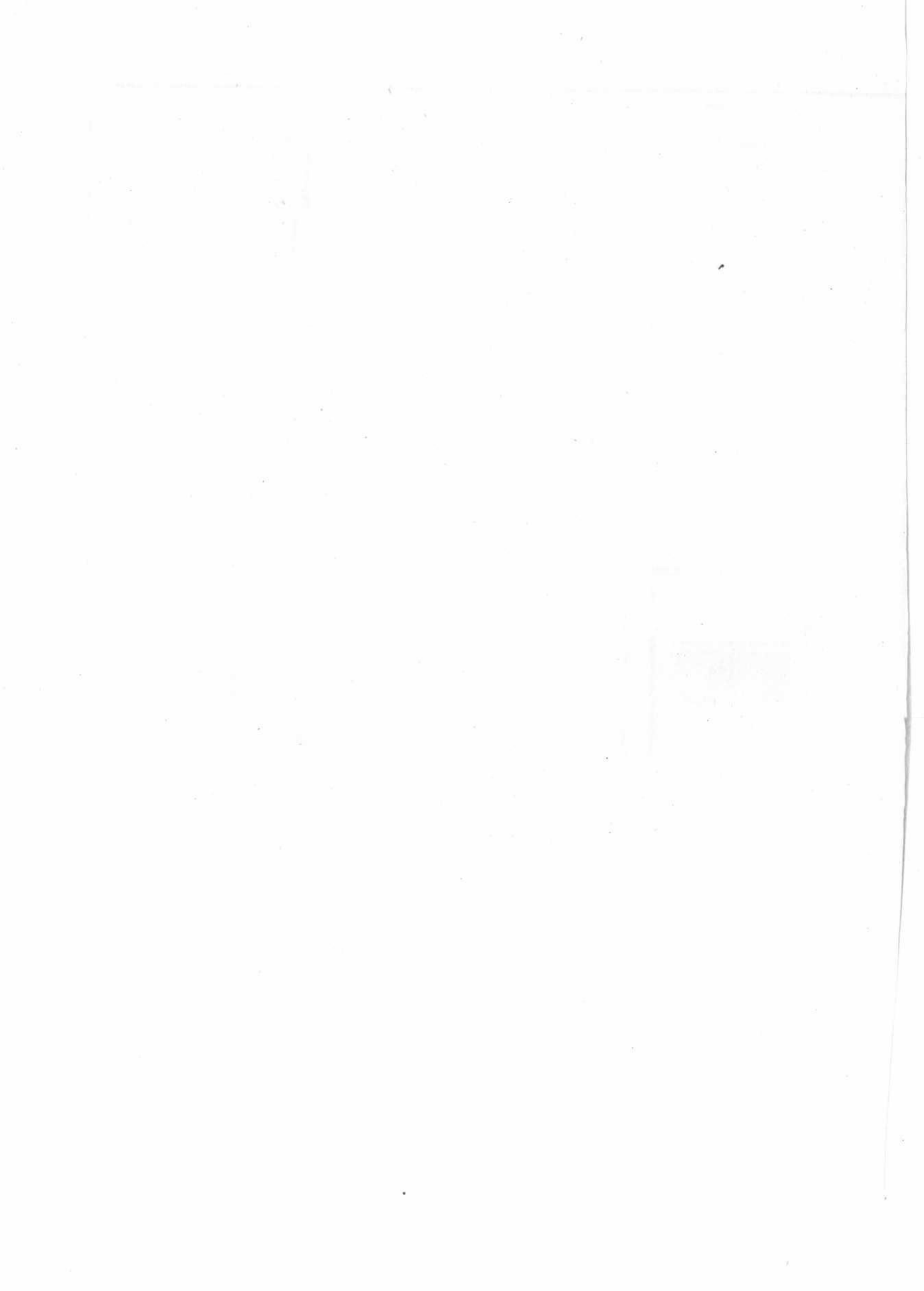
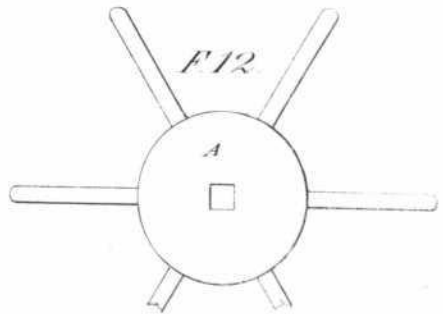
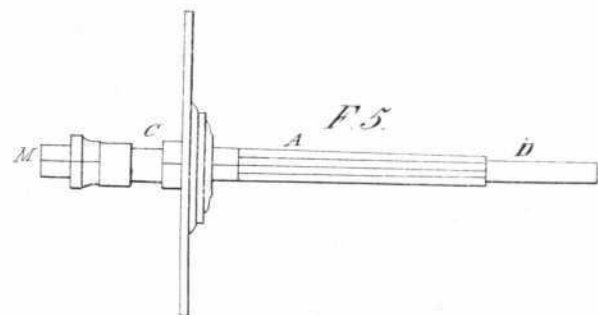
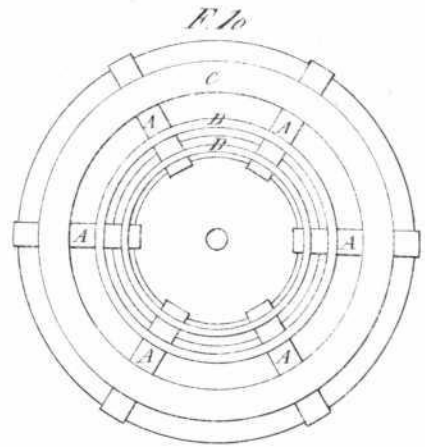
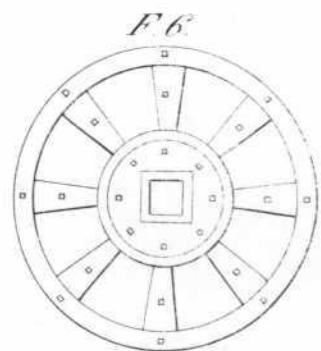
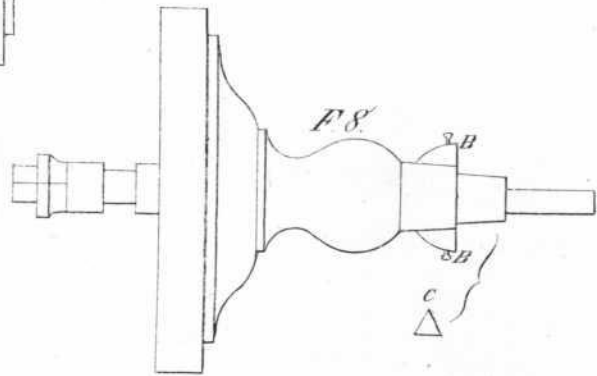
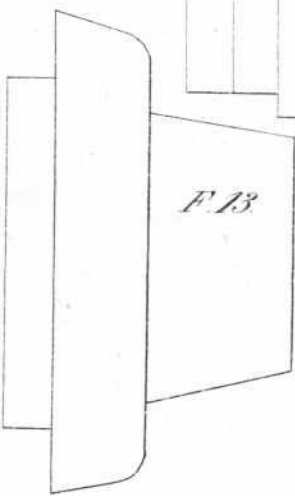
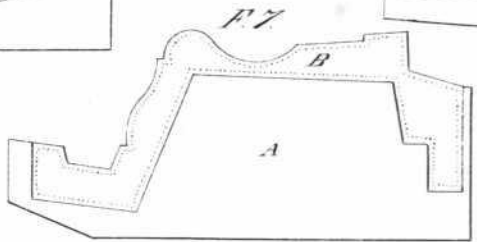
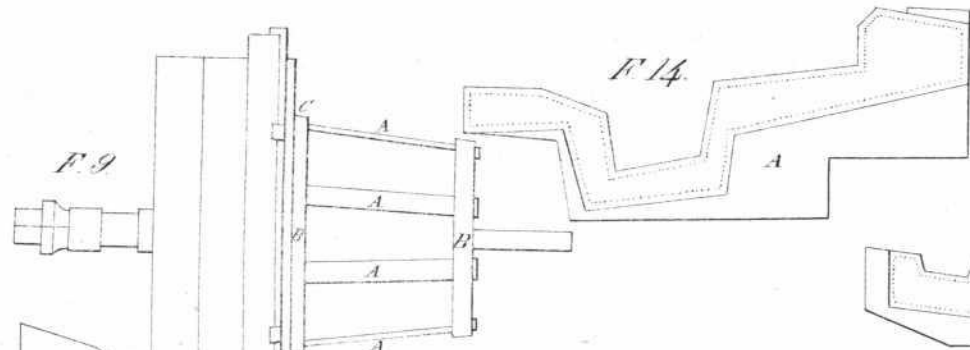
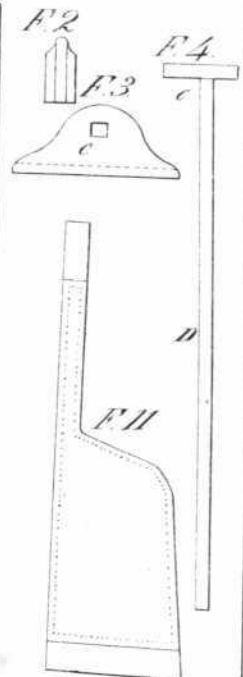
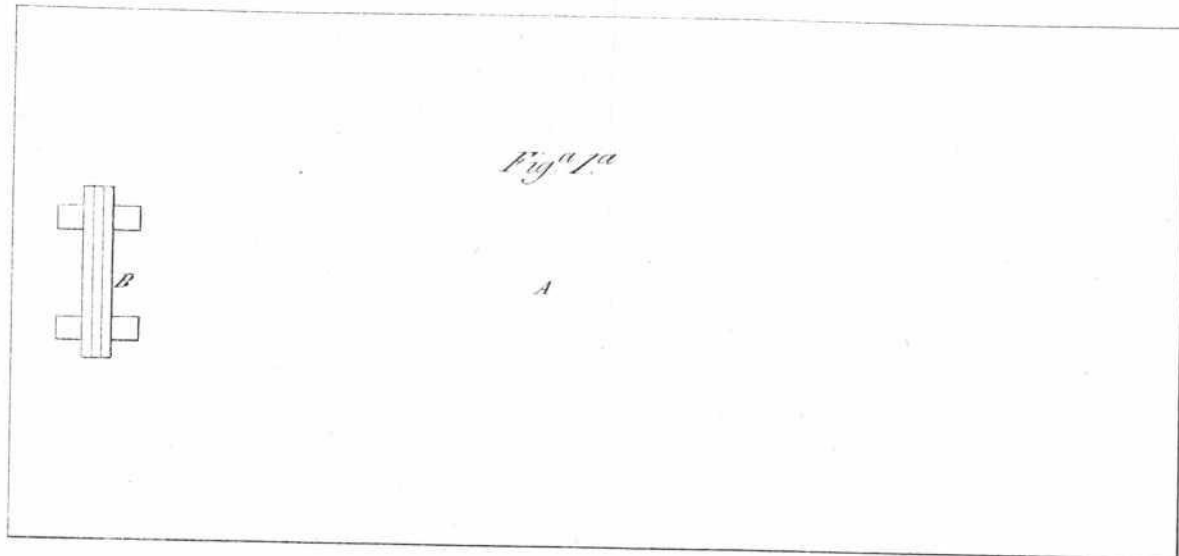


Fig. 4.





Fig^a 1^a



Escalas, una pulgada por pie de Paris.

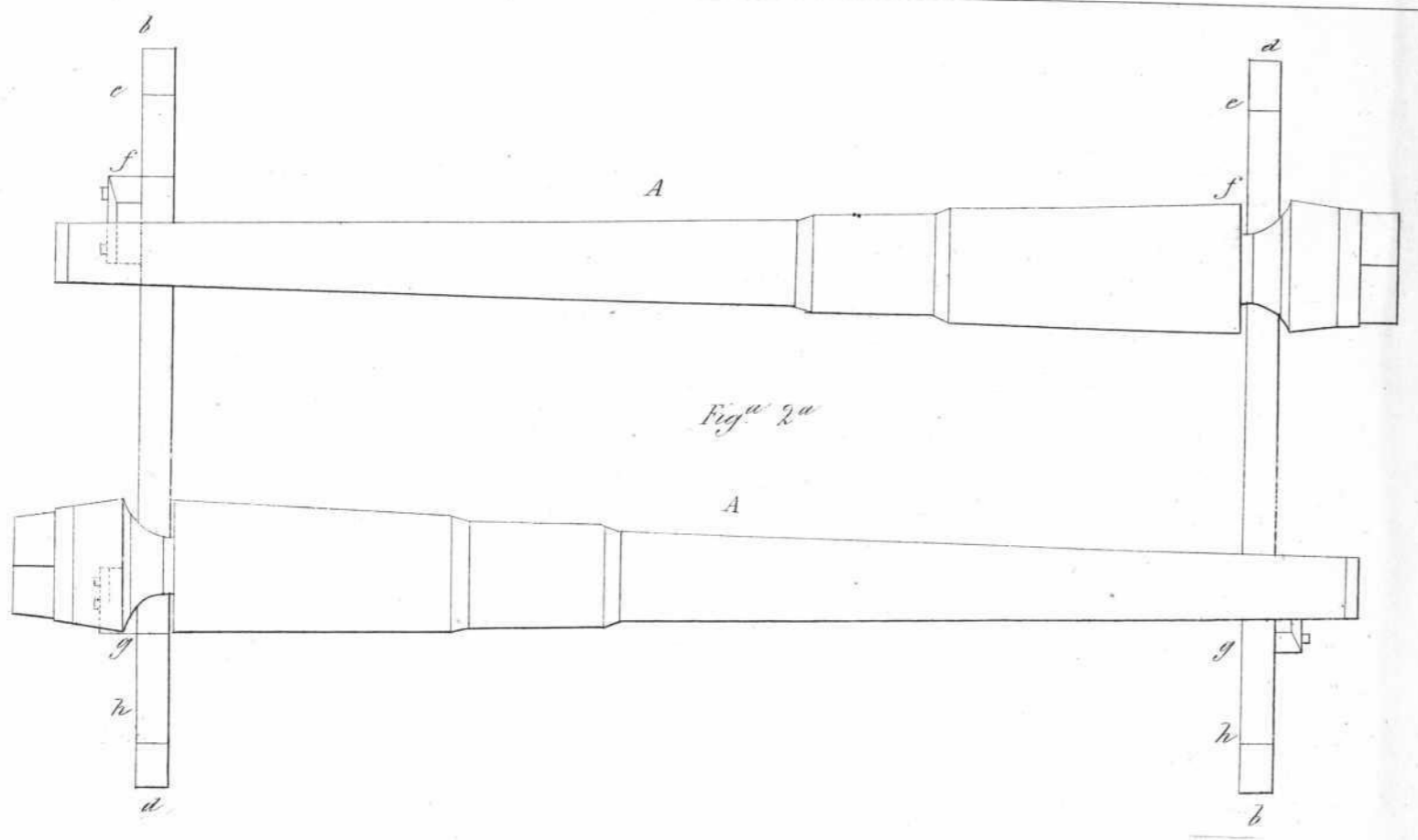


Fig. 2a

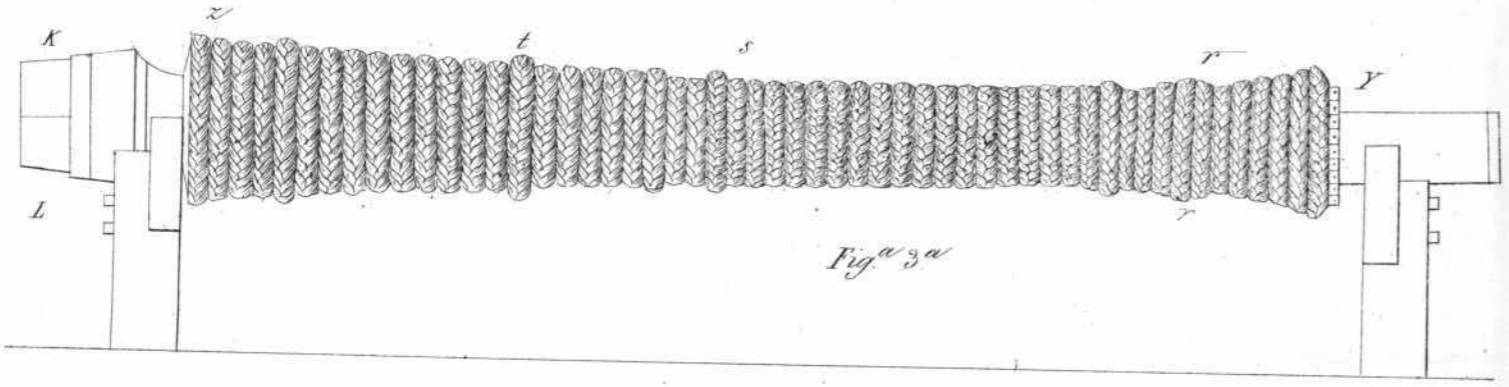


Fig. 3a

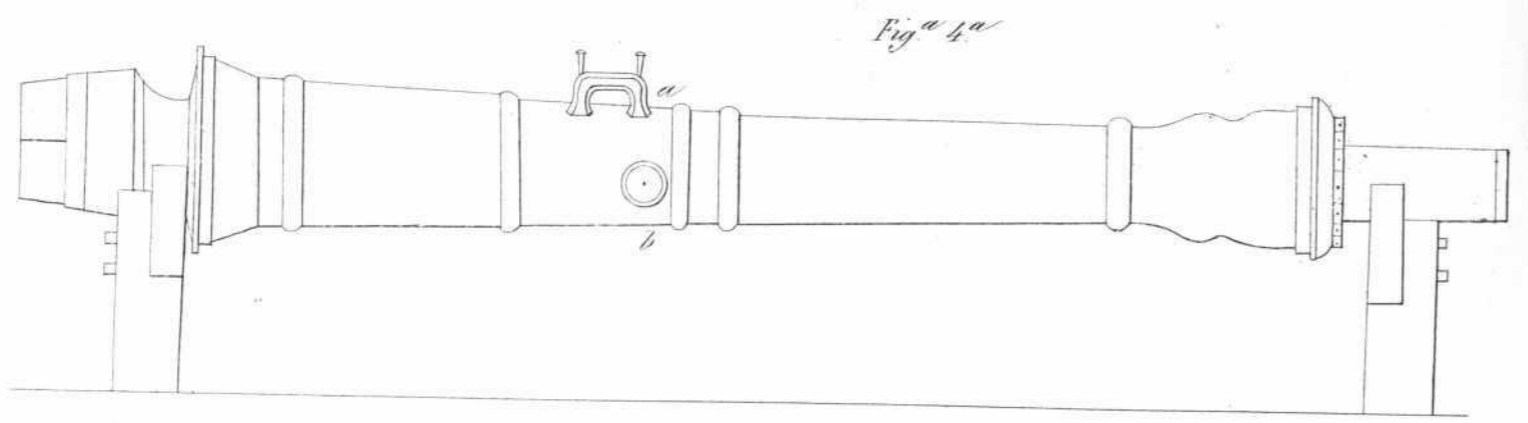


Fig. 4a

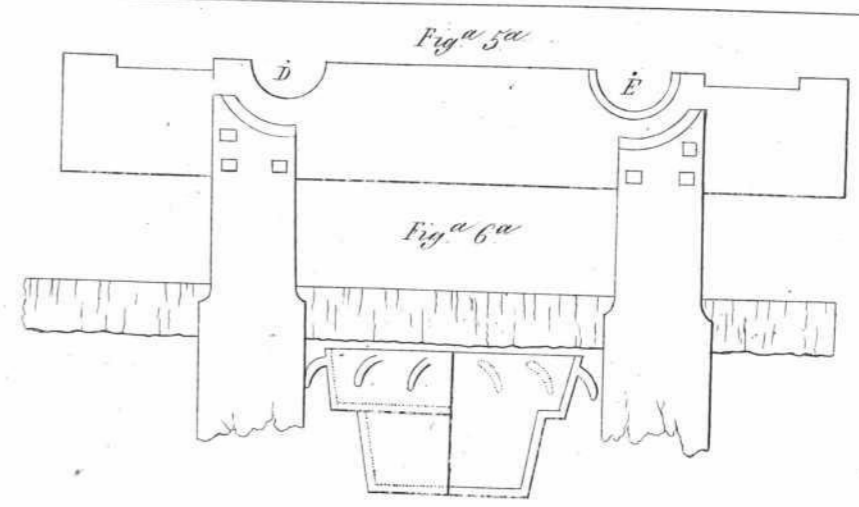


Fig. 5a

Fig. 6a

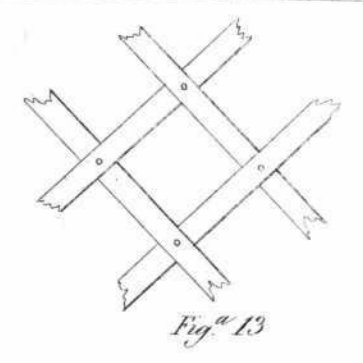


Fig. 13

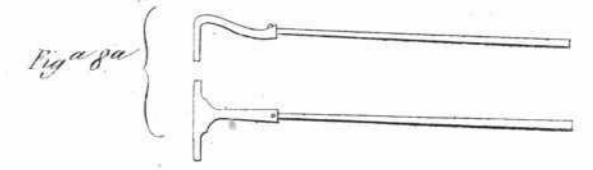


Fig. 8a

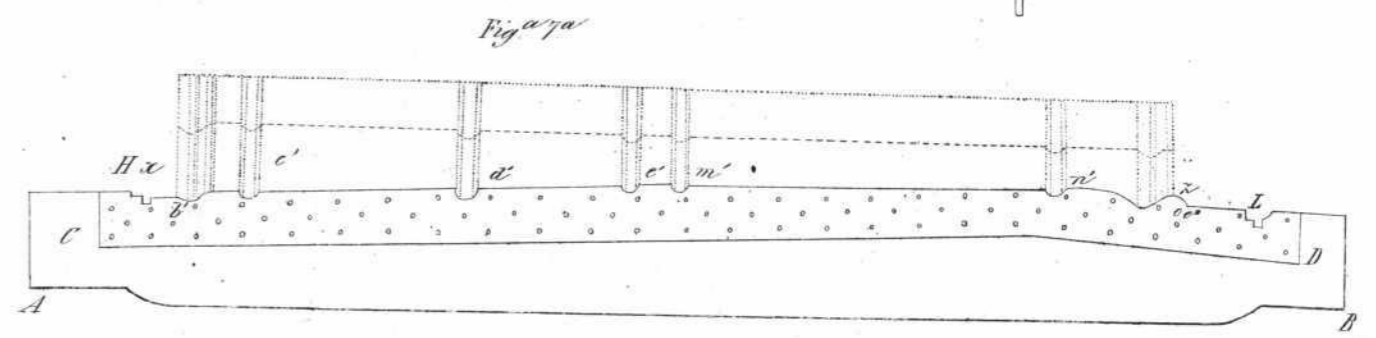


Fig. 7a

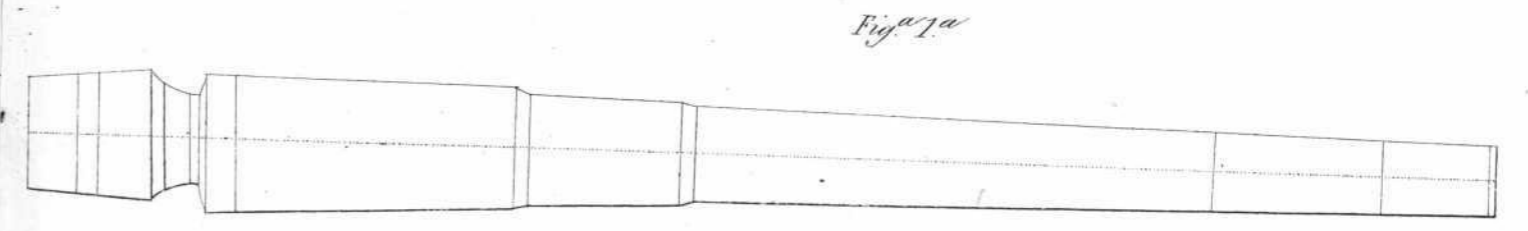
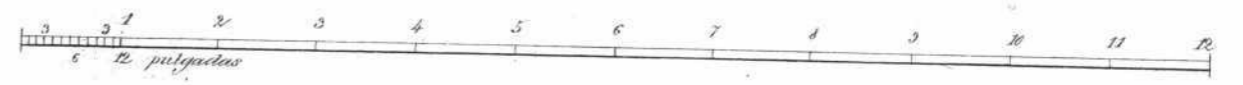


Fig. 1a



Piez de Rey



Fig 1^a

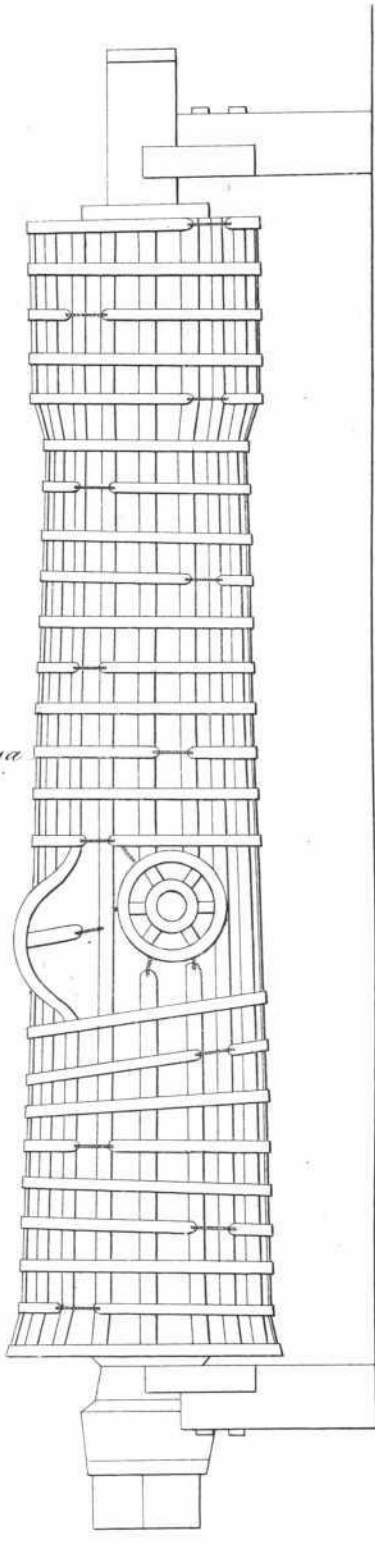


Fig 3^a

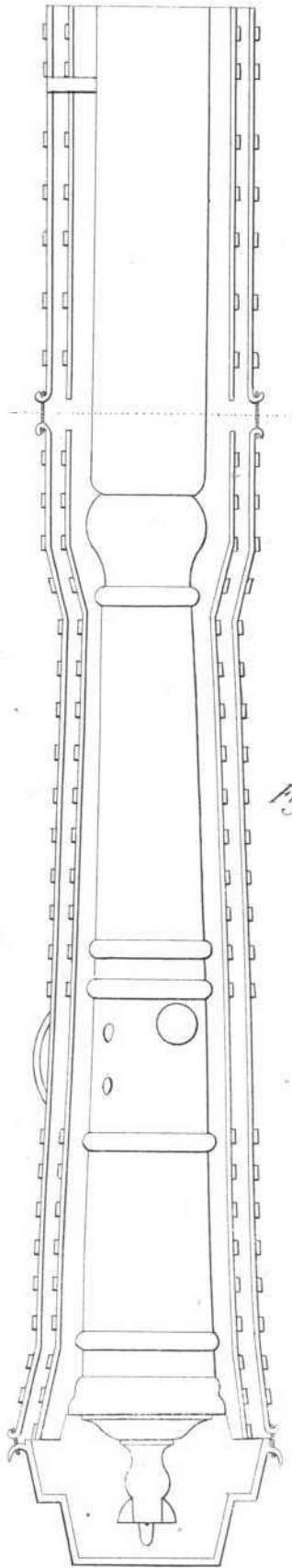
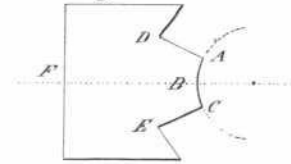


Fig 2^a



1 2 3 4 5 6 7 8 9 10 pies de Rey

Fig.^a 6.^a

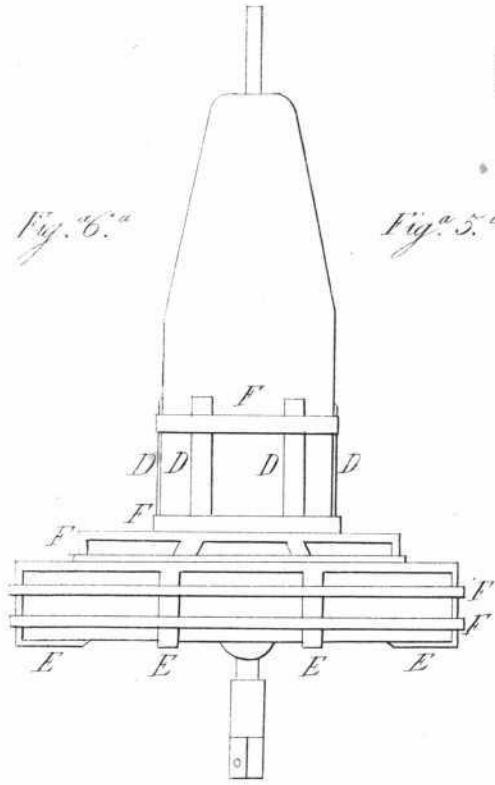


Fig.^a 5.^a

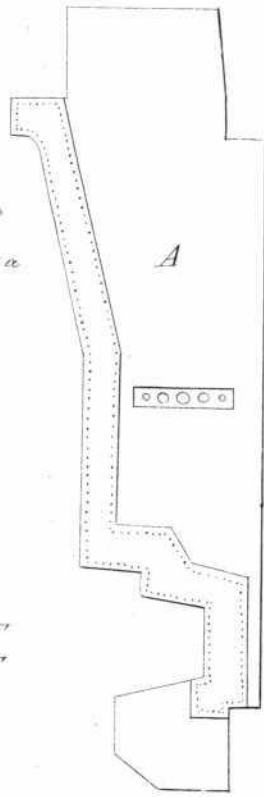
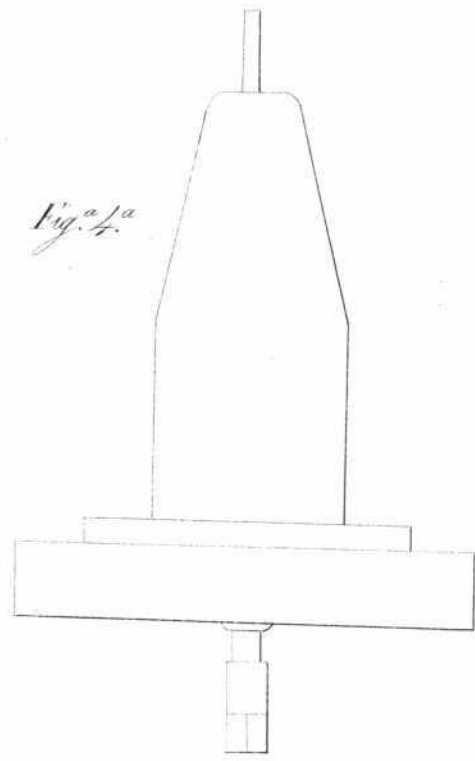


Fig.^a 4.^a



Escala de una ^{pal.} por pie de Paris.

Fig.^a 1.^a



Fig.^a 2.^a

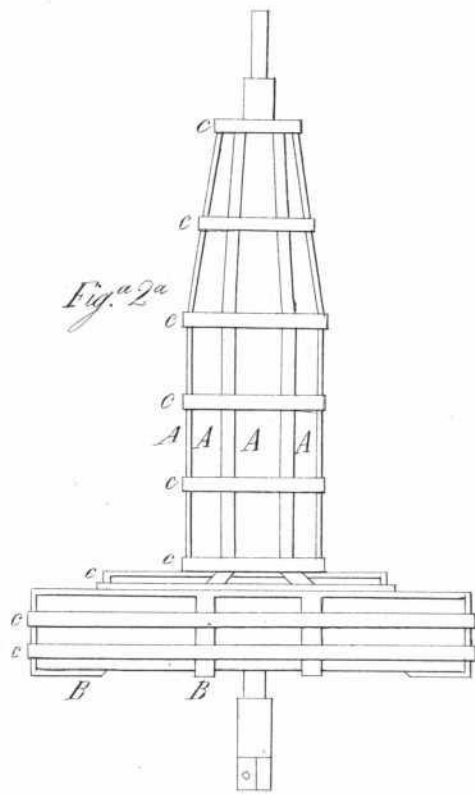


Fig.^a 3.^a

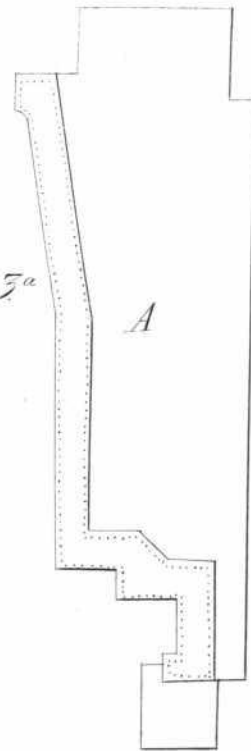


Fig.^o 1^a



Fig.^o 3^a

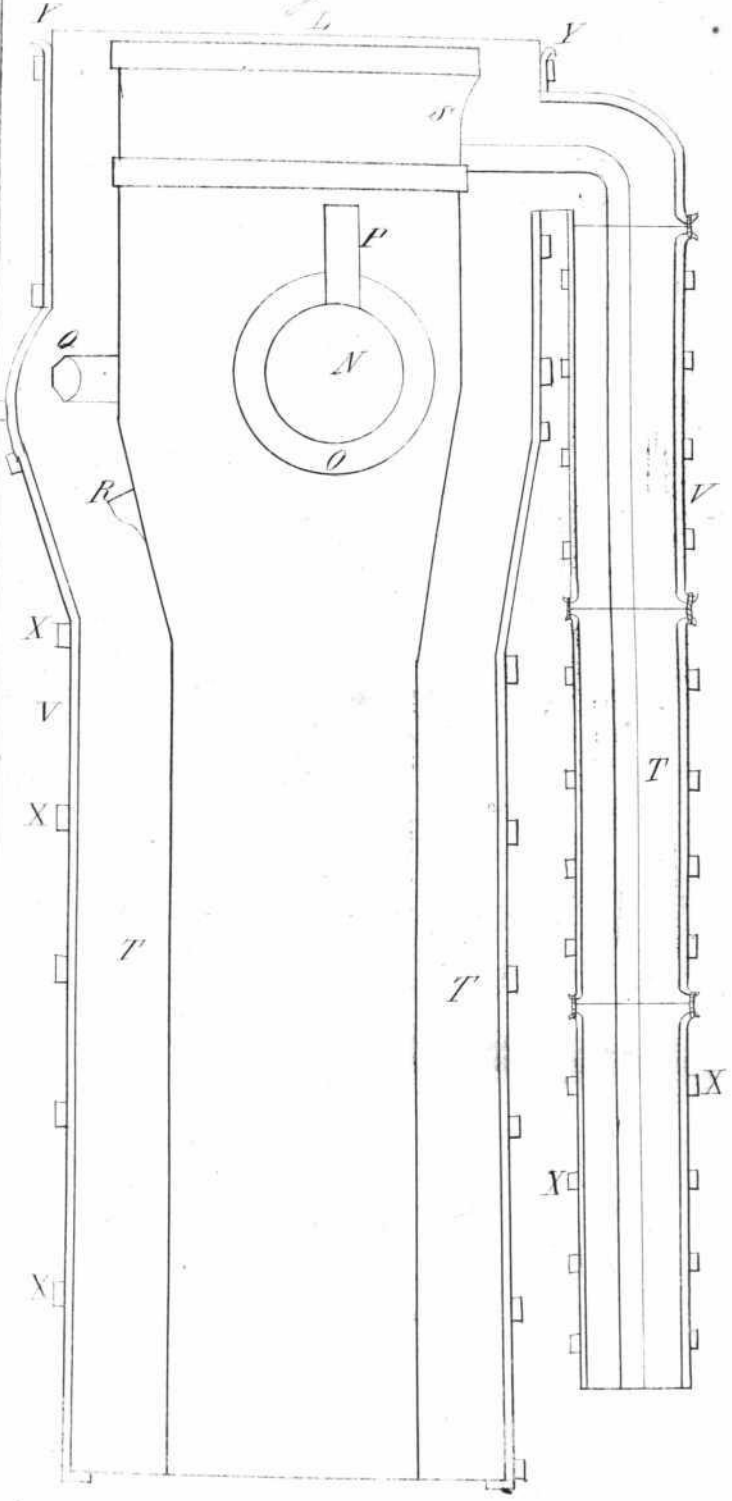


Fig.^o 2^a

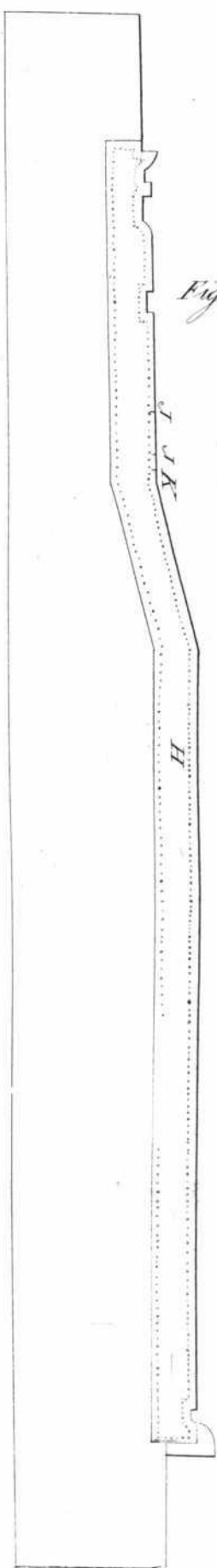
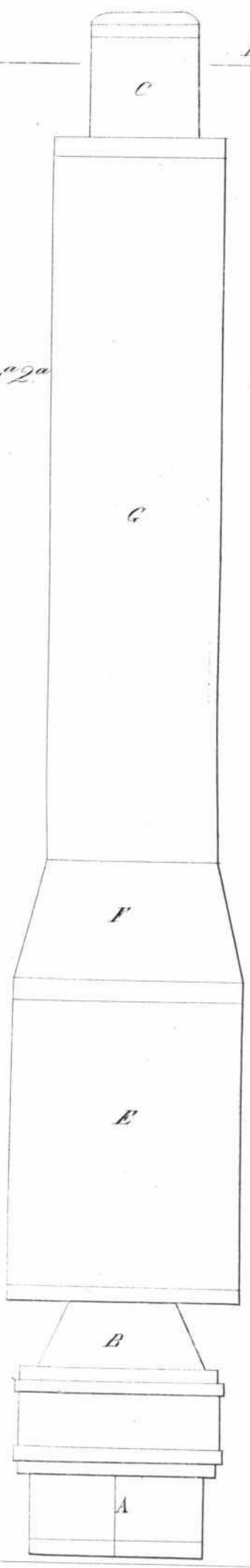
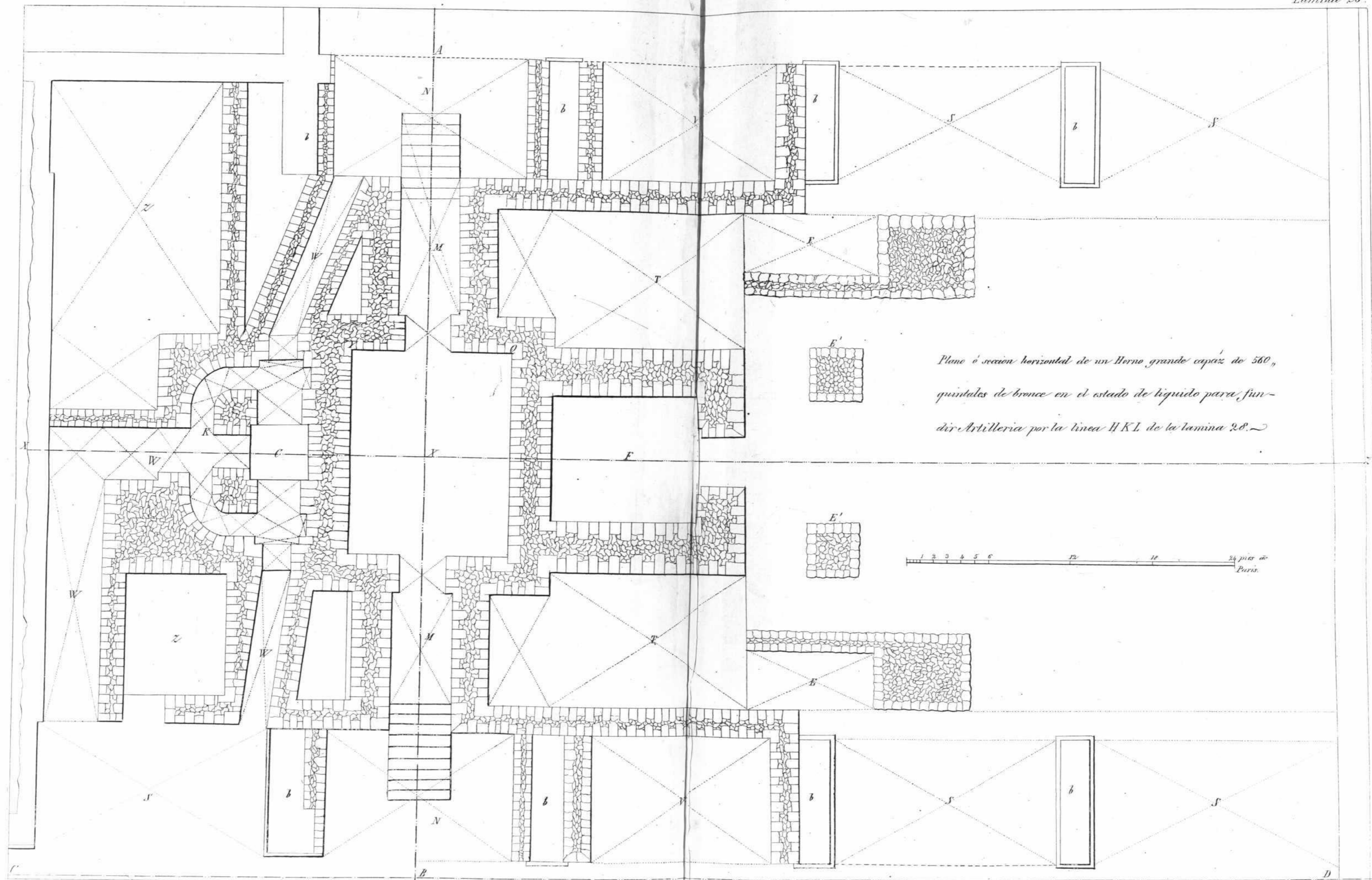


Fig.^o 4^a



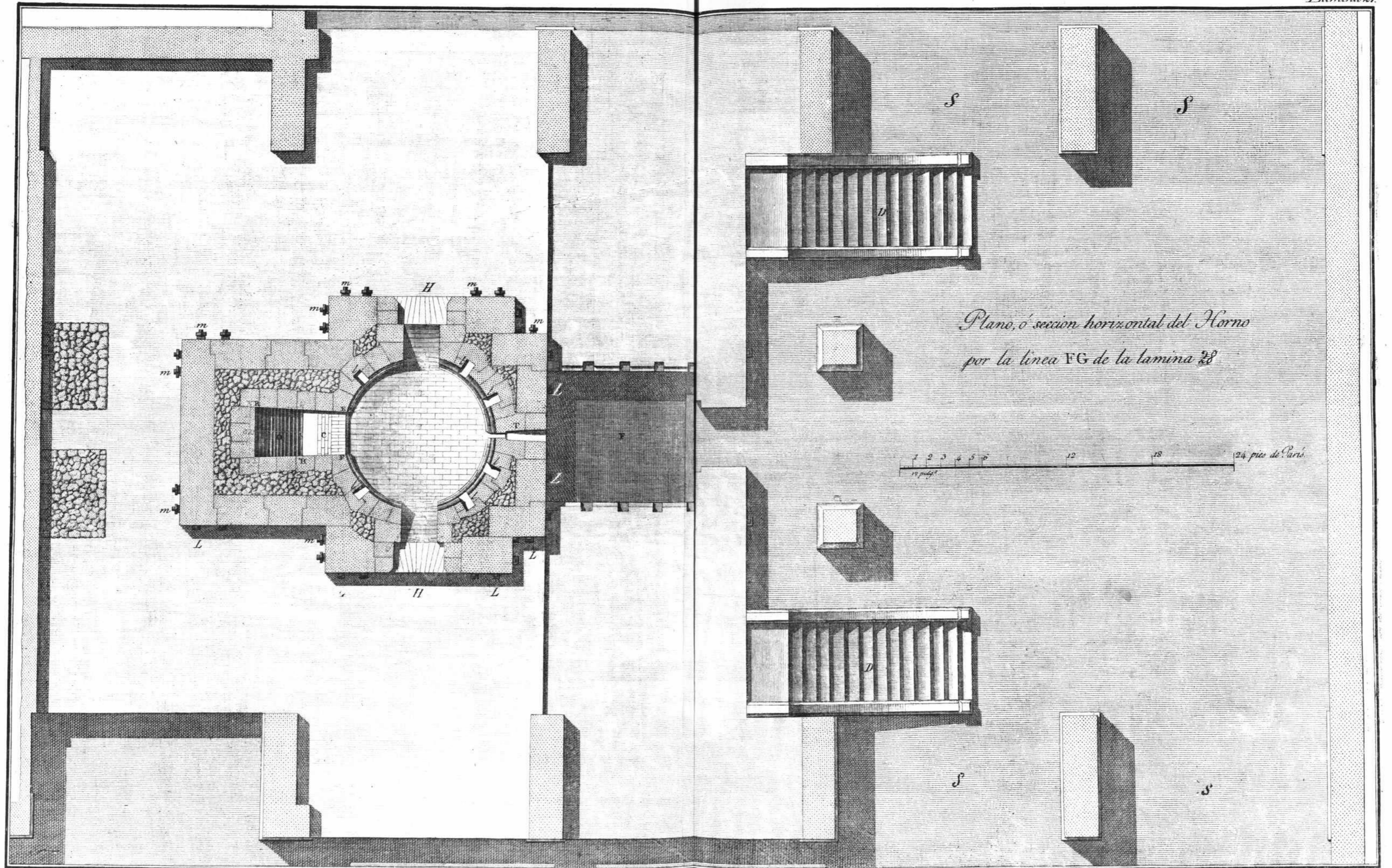




Plano ó seccion horizontal de un Horno grande capaz de 560 quintales de bronce en el estado de liquido para fundir Artilleria por la linea H K L de la lamina 28.

1 2 3 4 5 6 12 18 24 pies de Paris.



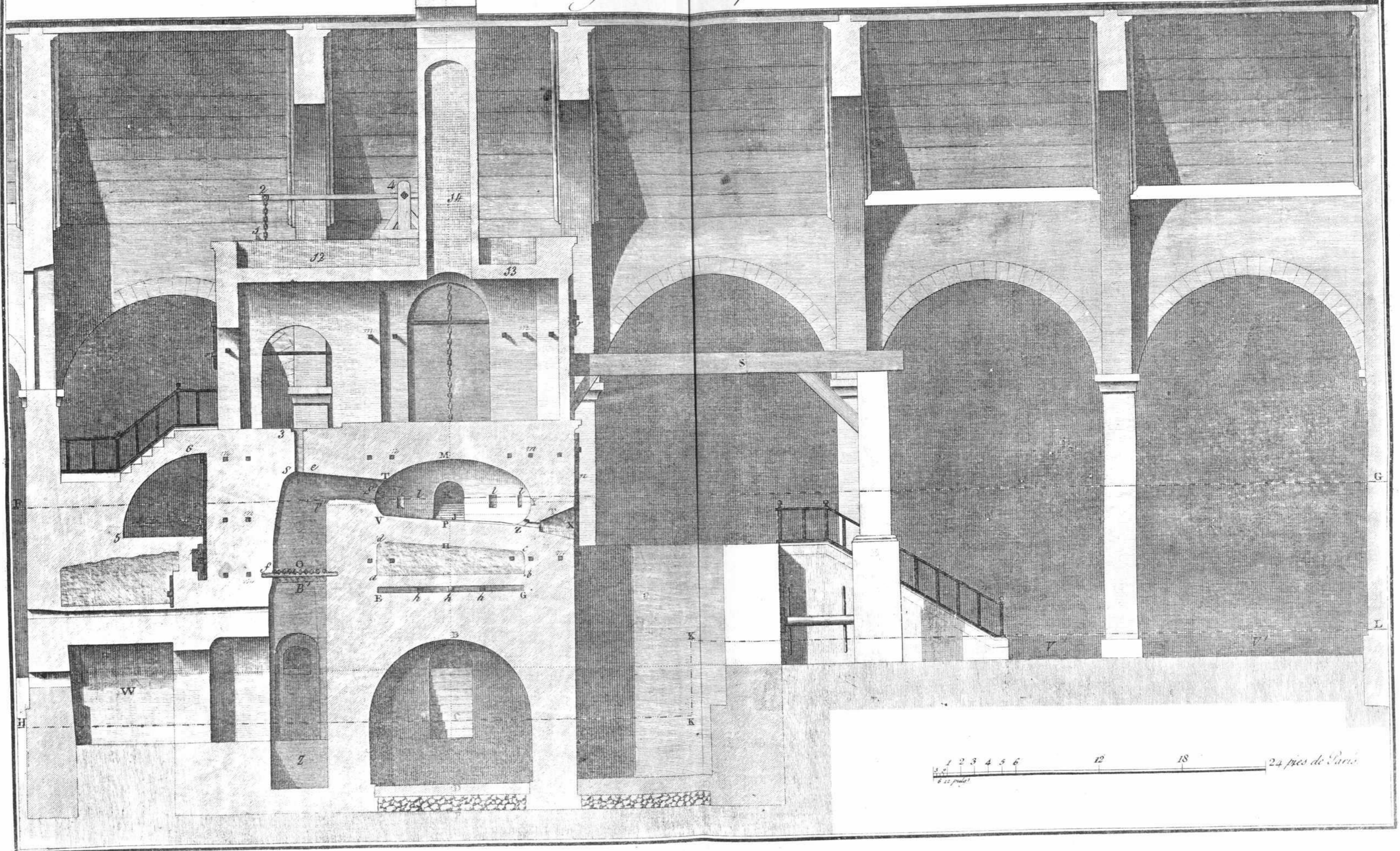


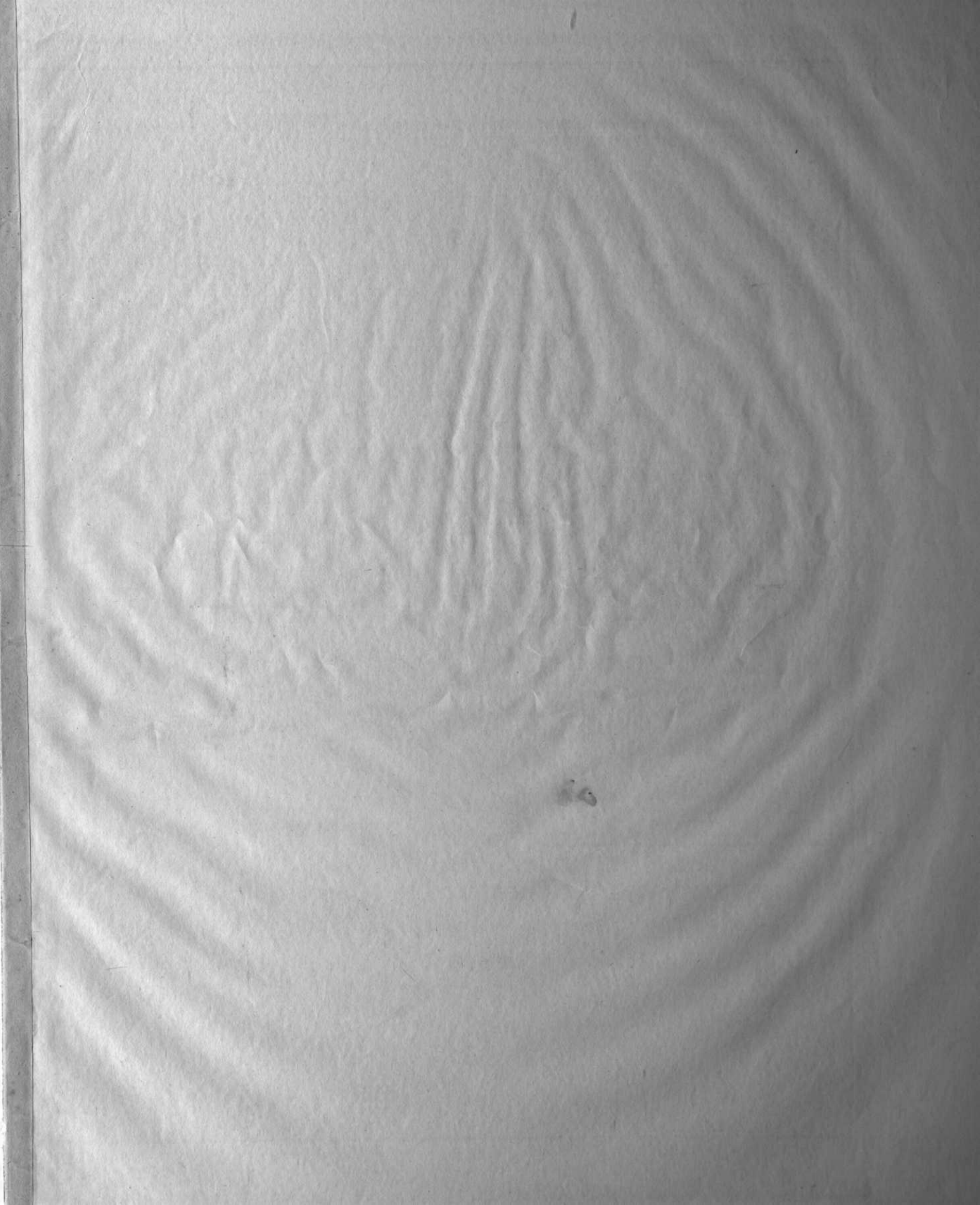
*Plano, ó seccion horizontal del Horno
por la linea FG de la lamina 28*

1 2 3 4 5 6 12 18 24 pies de Paris

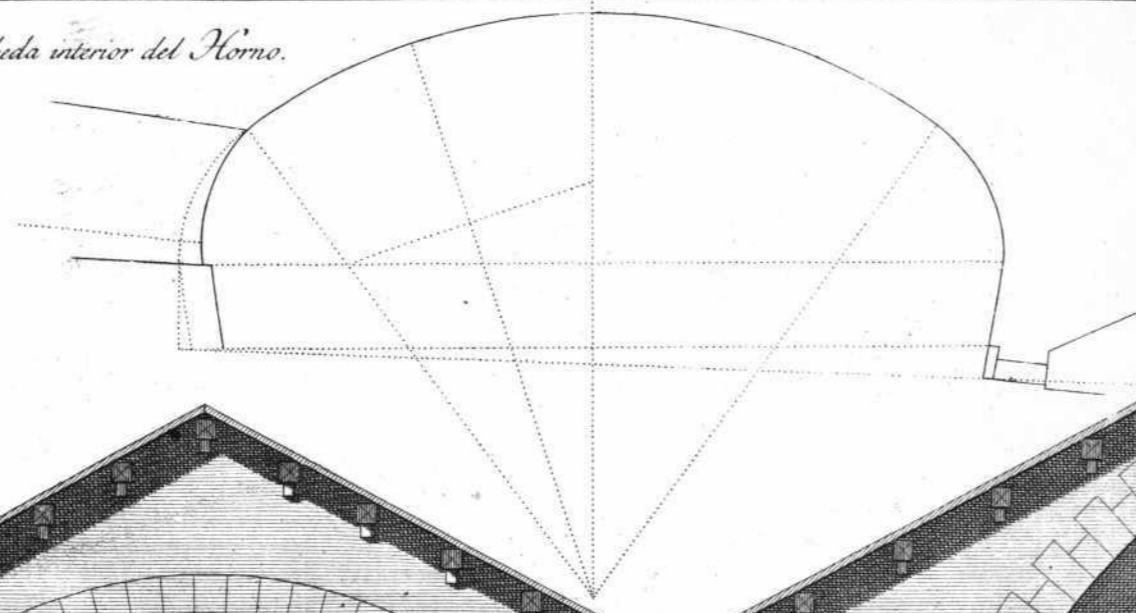


Perfil del Horno por la linea XZ de la lamina 26



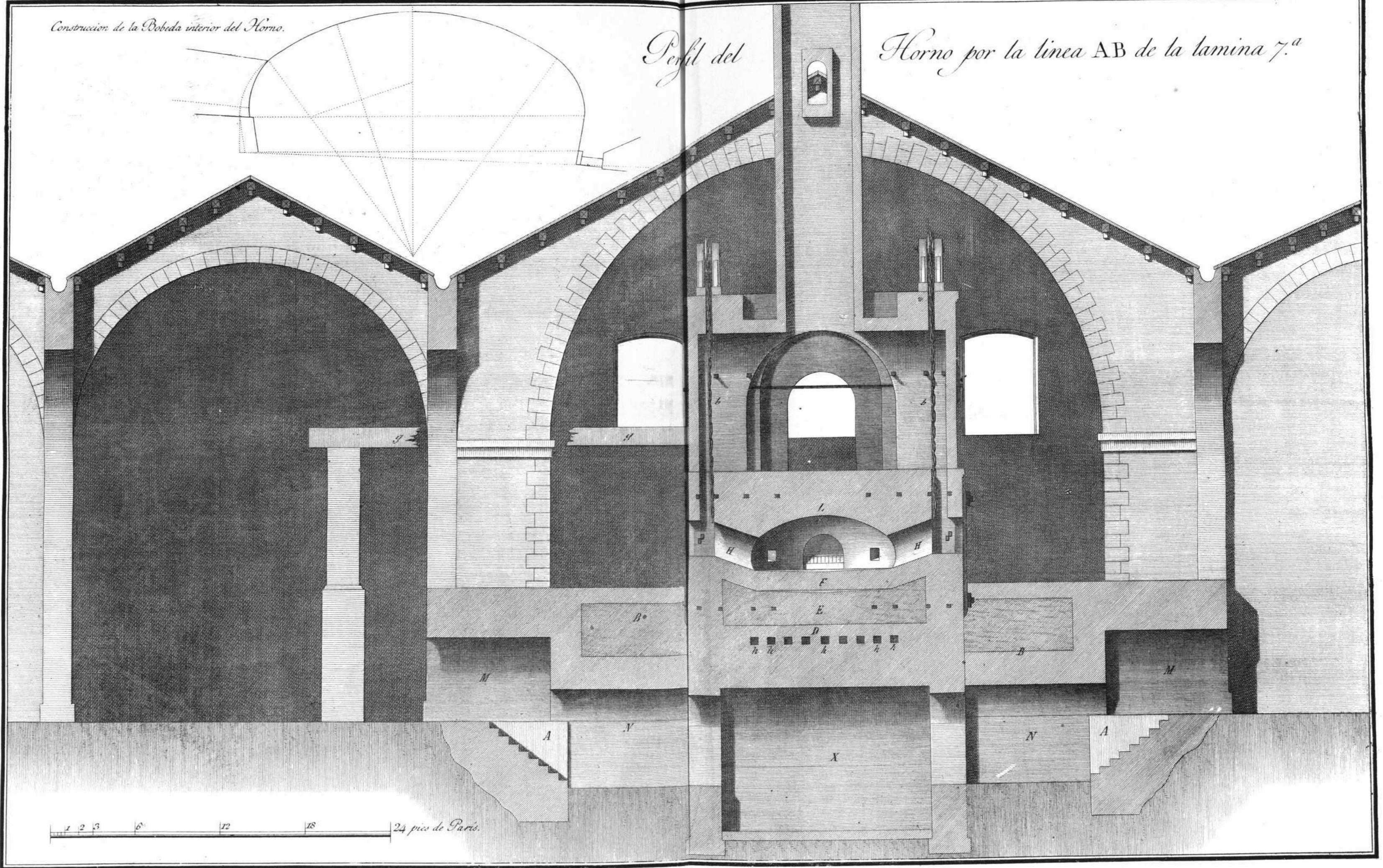


Construccion de la Bobada interior del Horno.

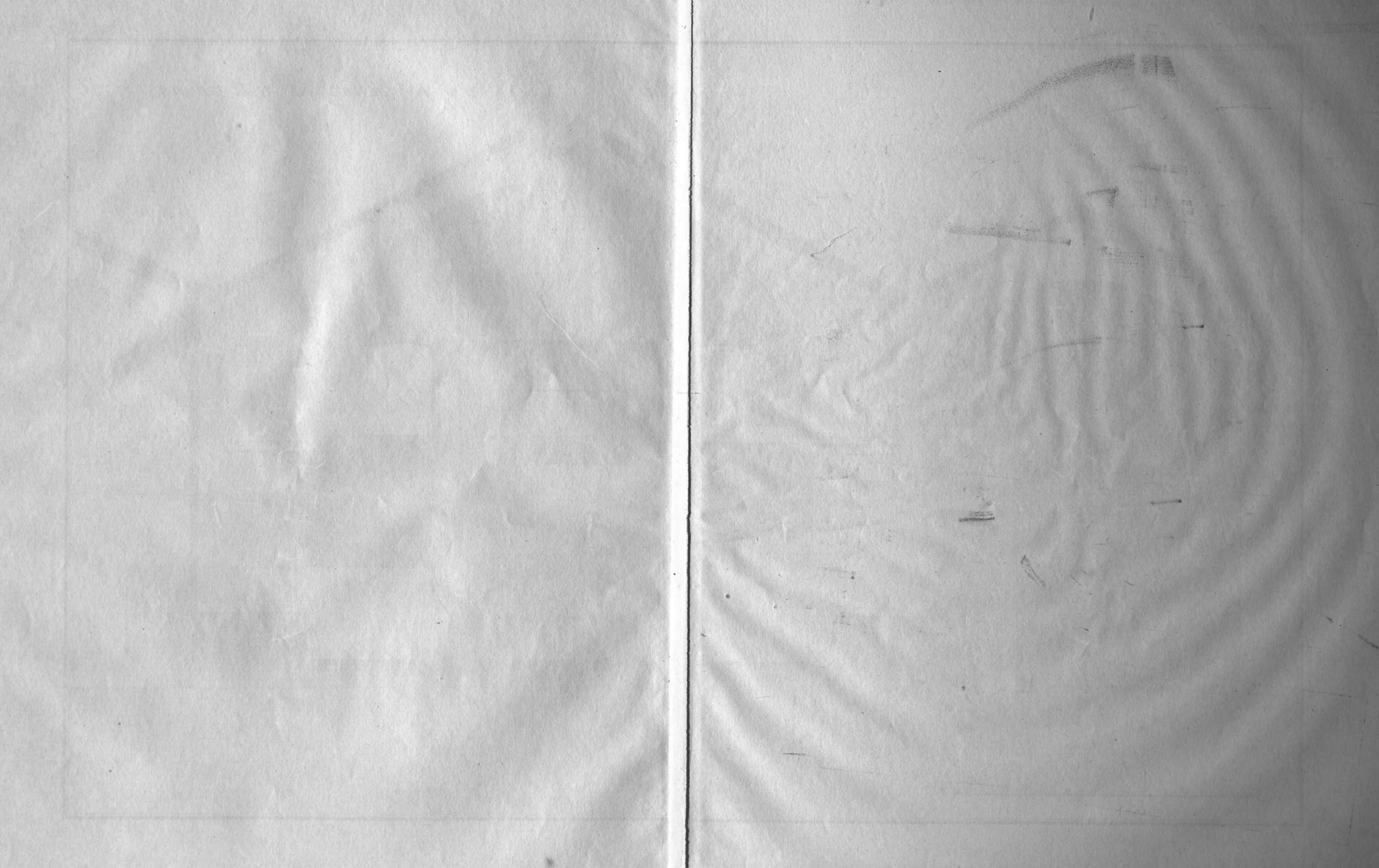


Perfil del

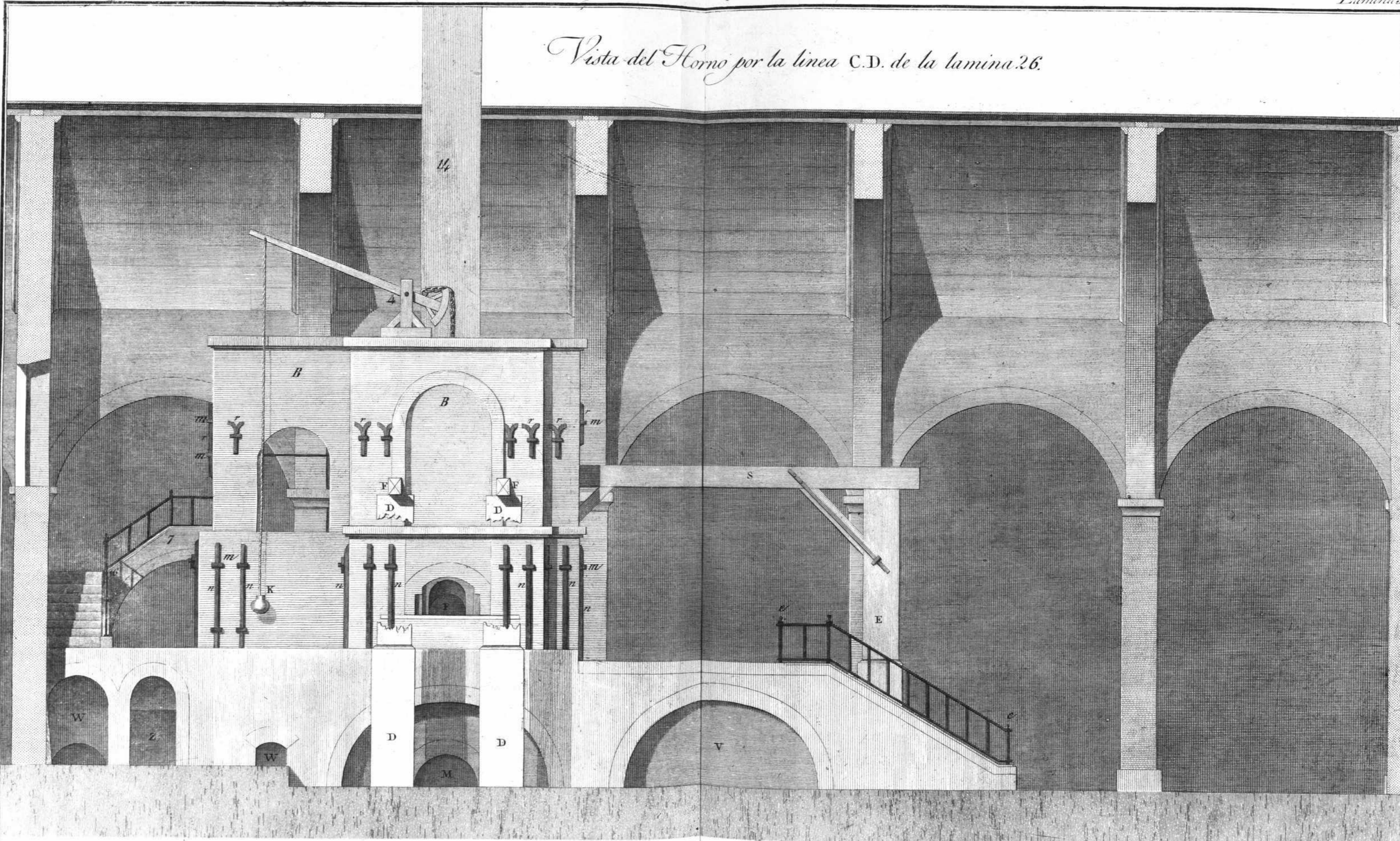
Horno por la linea AB de la lamina 7.^a



1 2 3 6 12 18 24 pico de Paris.



Vista del Horno por la linea C.D. de la lamina 26.



3 9 1 2 3 4 5 6 12 18 24 30 36 42 48 pies de Paris.

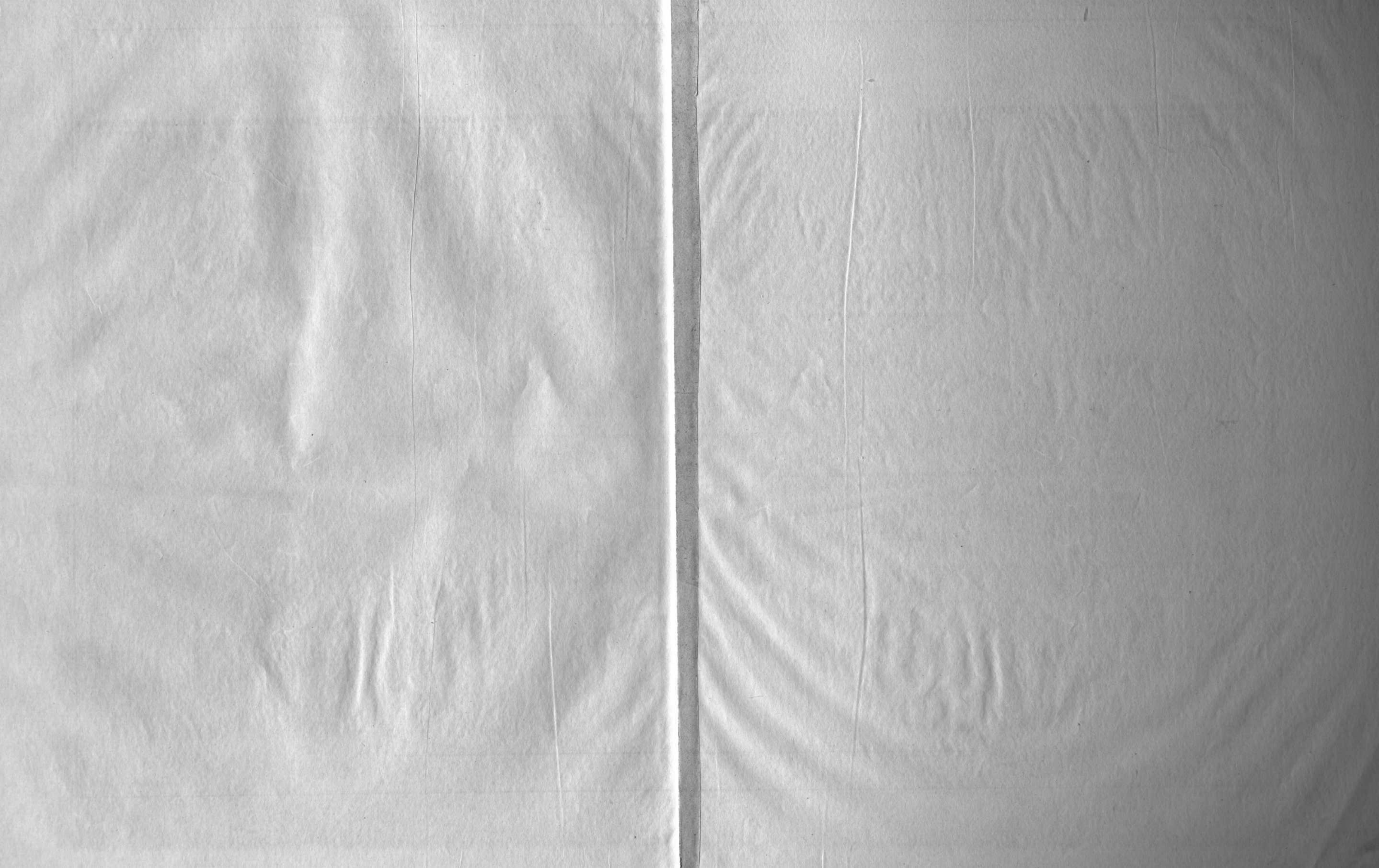


Fig. 1.

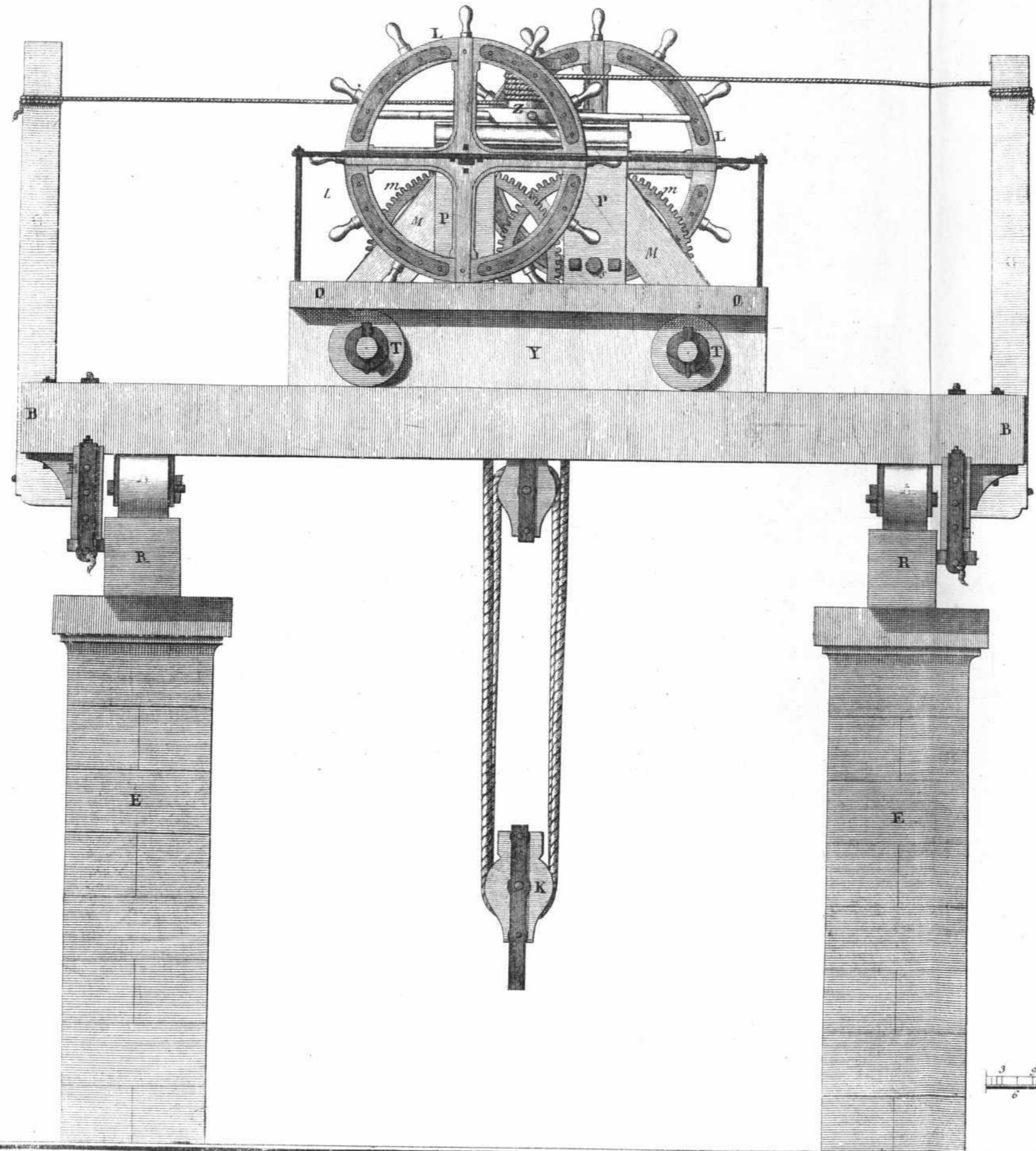
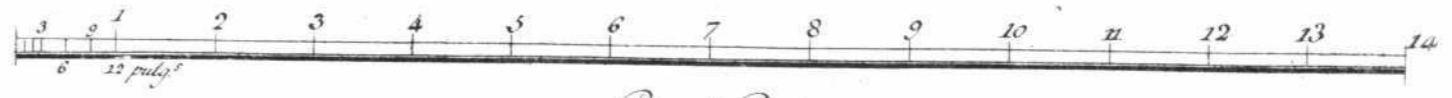
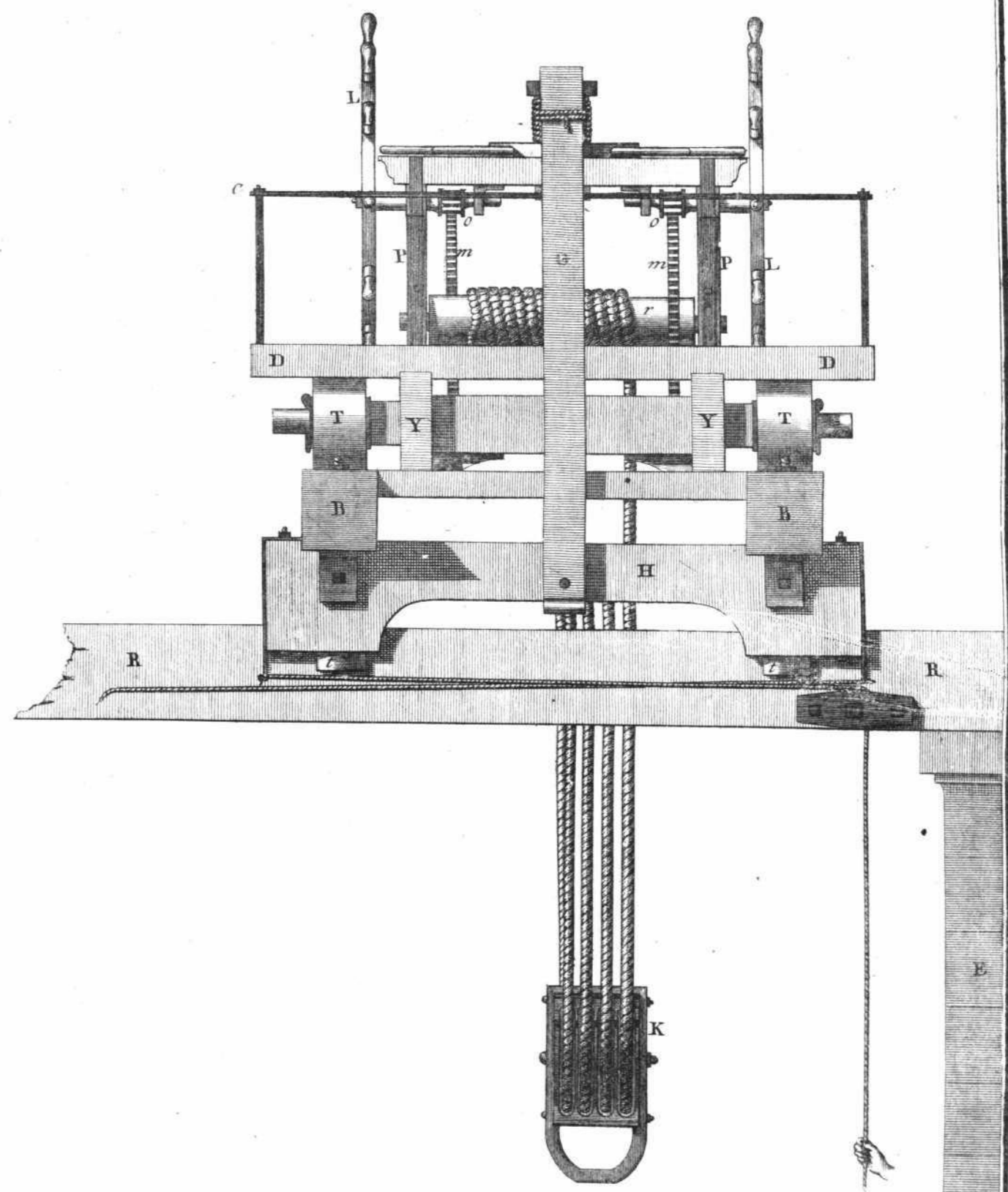


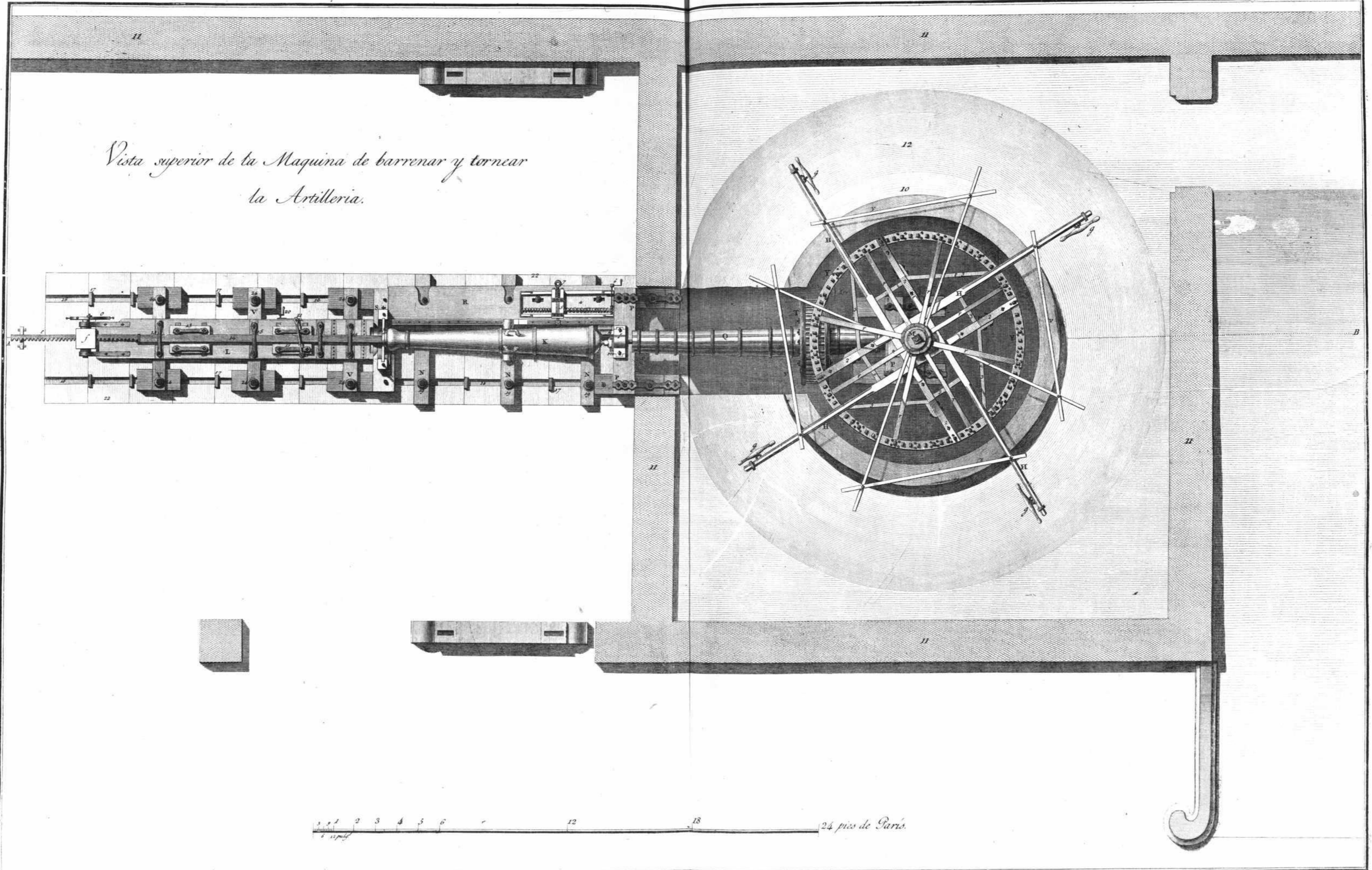
Fig. 2.



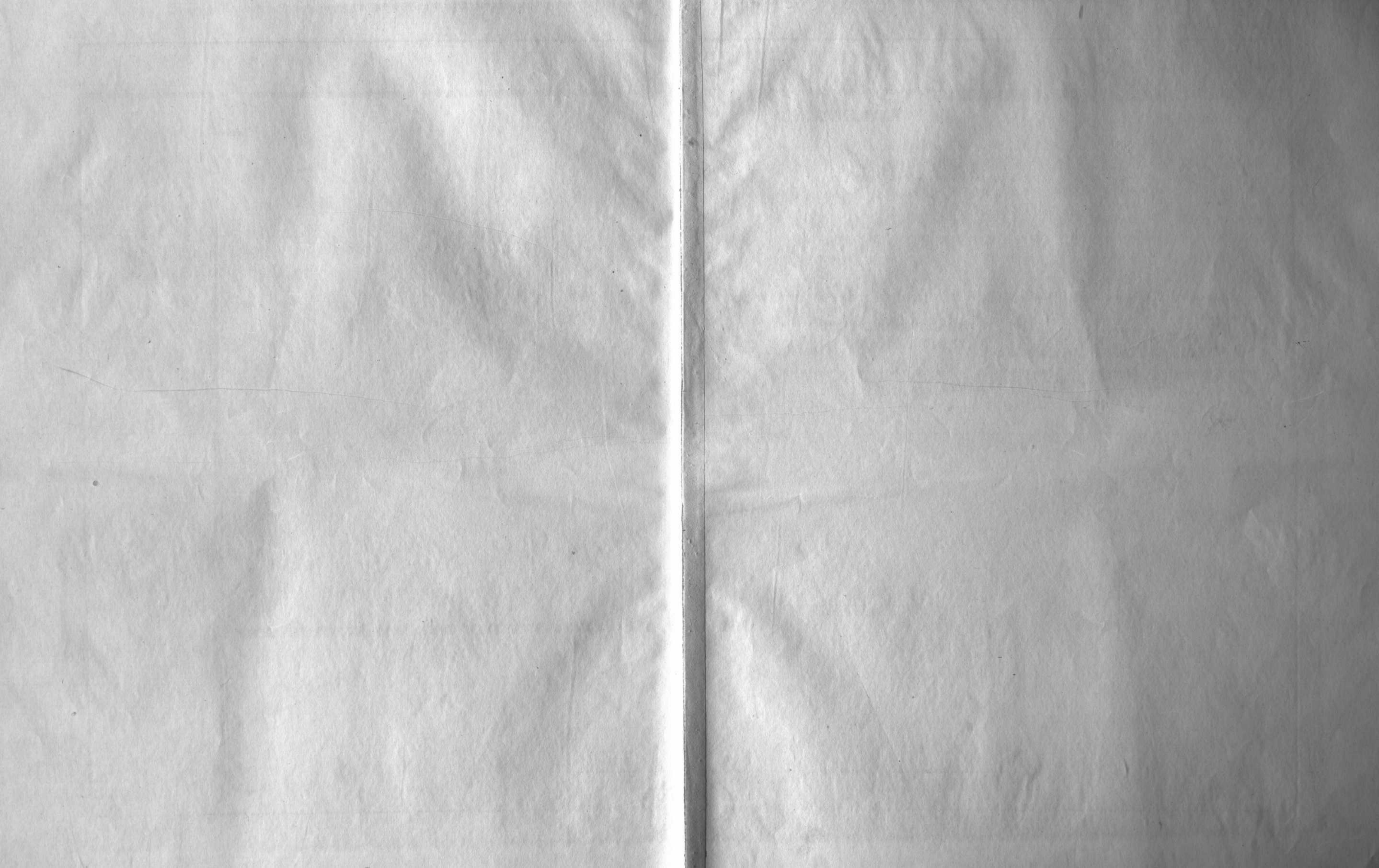
Pies de Paris.



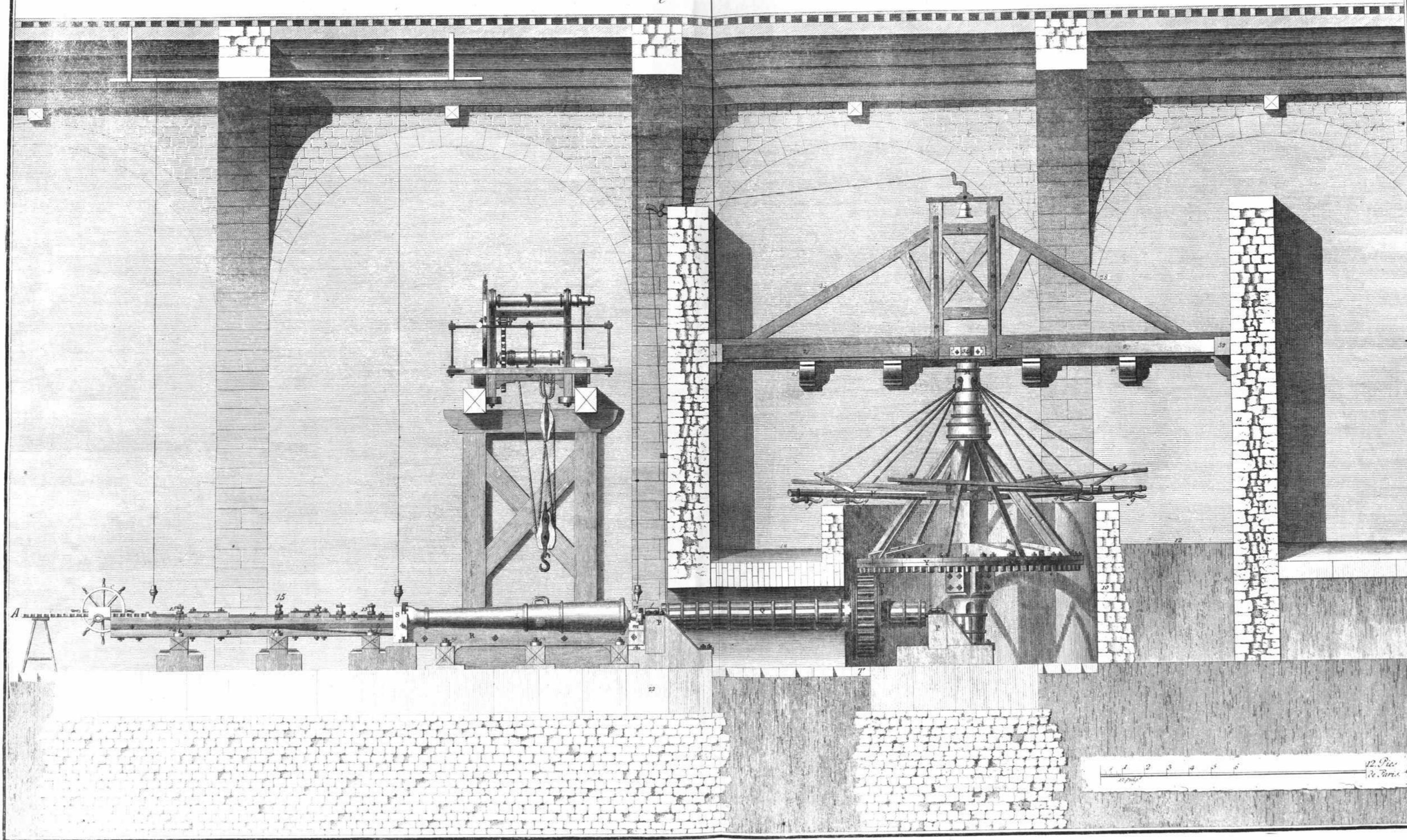
Vista superior de la Maquina de barrenar y torncar
la Artilleria.

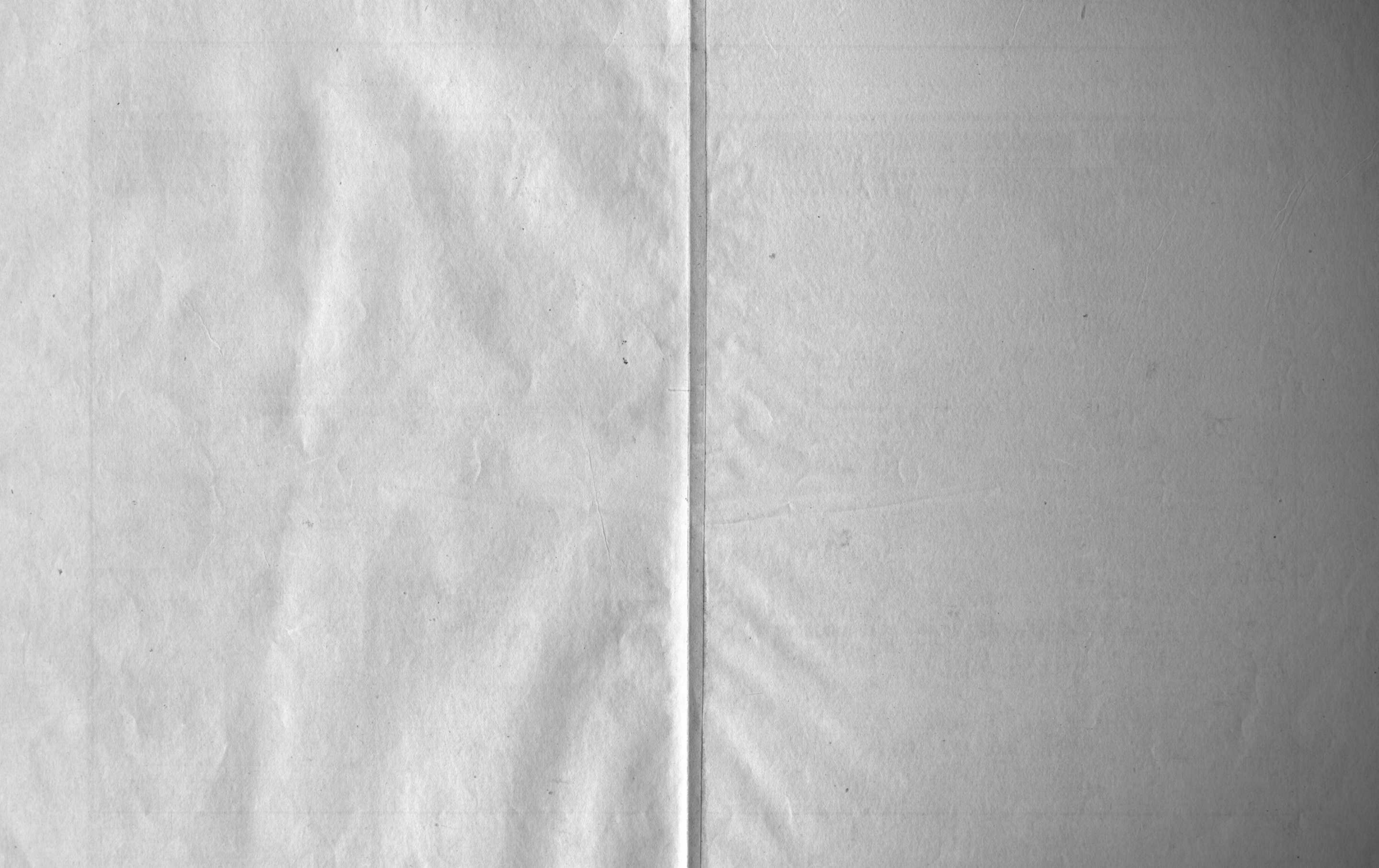


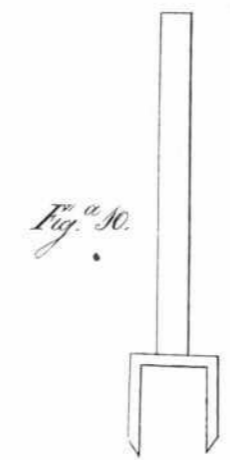
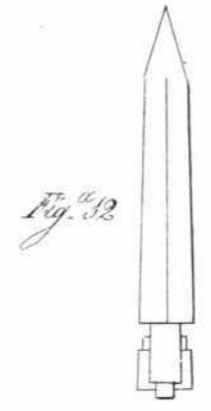
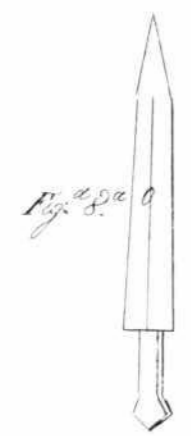
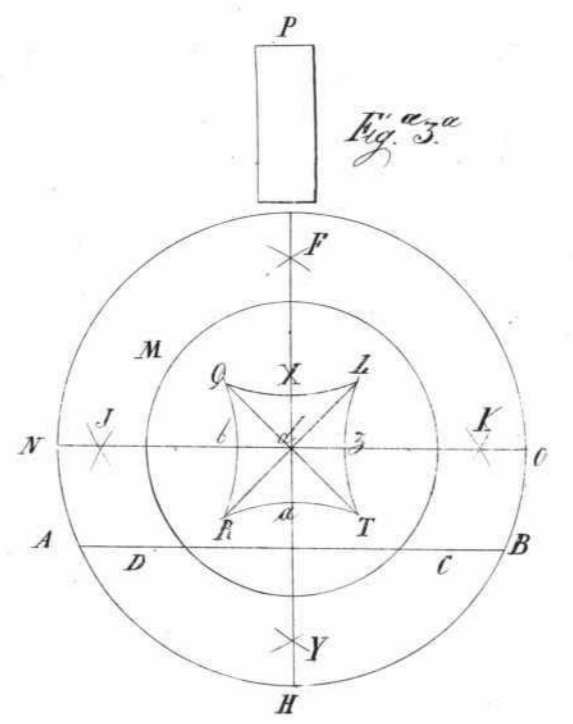
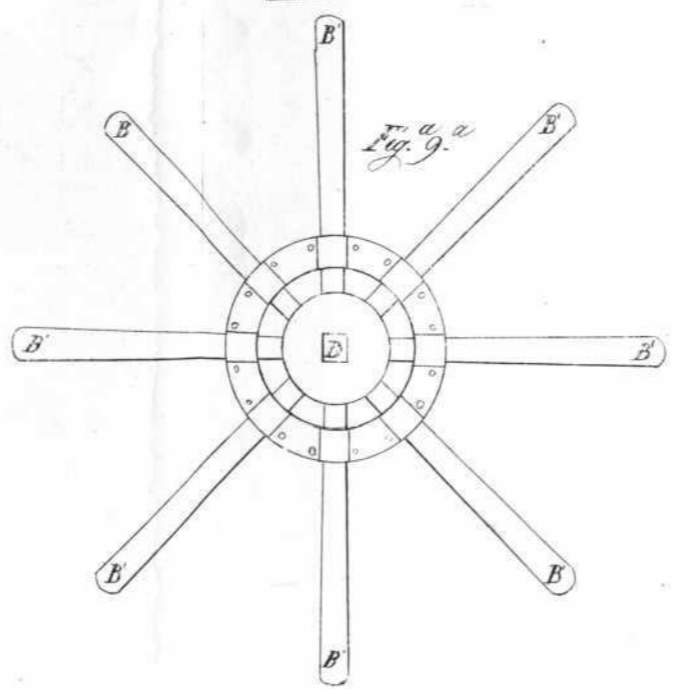
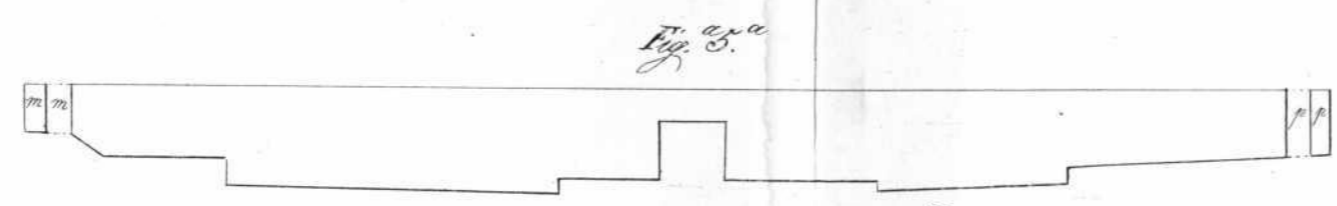
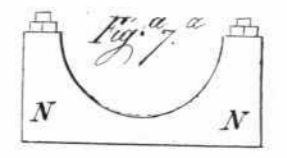
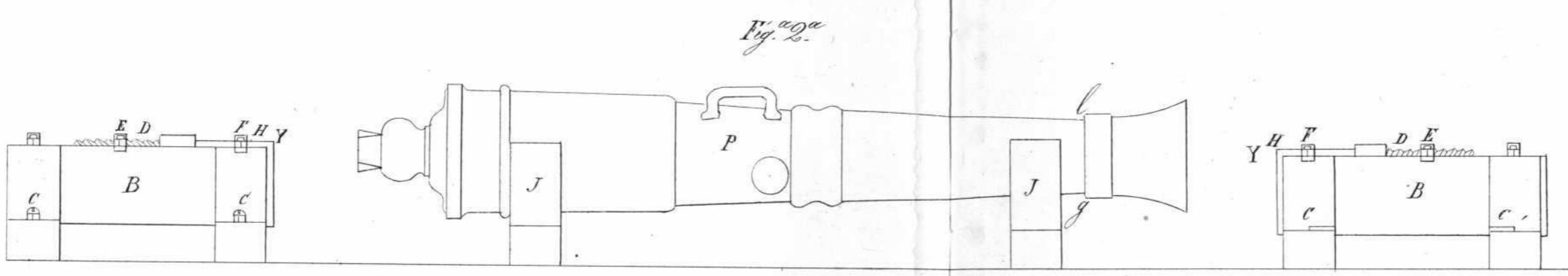
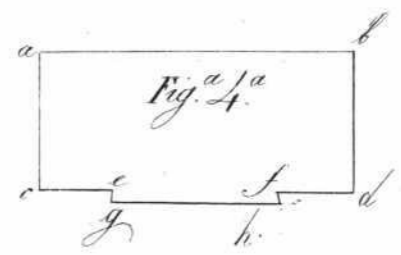
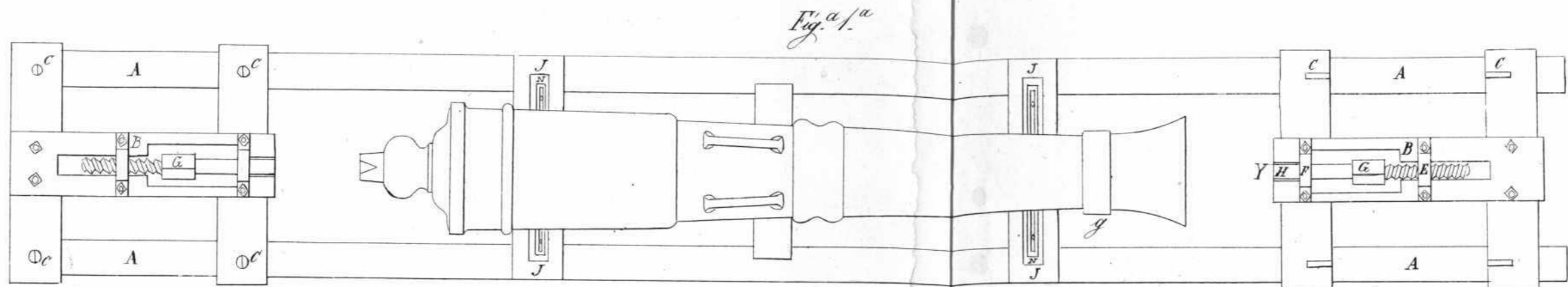
1 2 3 4 5 6 12 18 24 pies de Paris.



Perfil de la Maquina de barrenar y tornar los Cañones de Artilleria, cortado p.^a la linea AB.

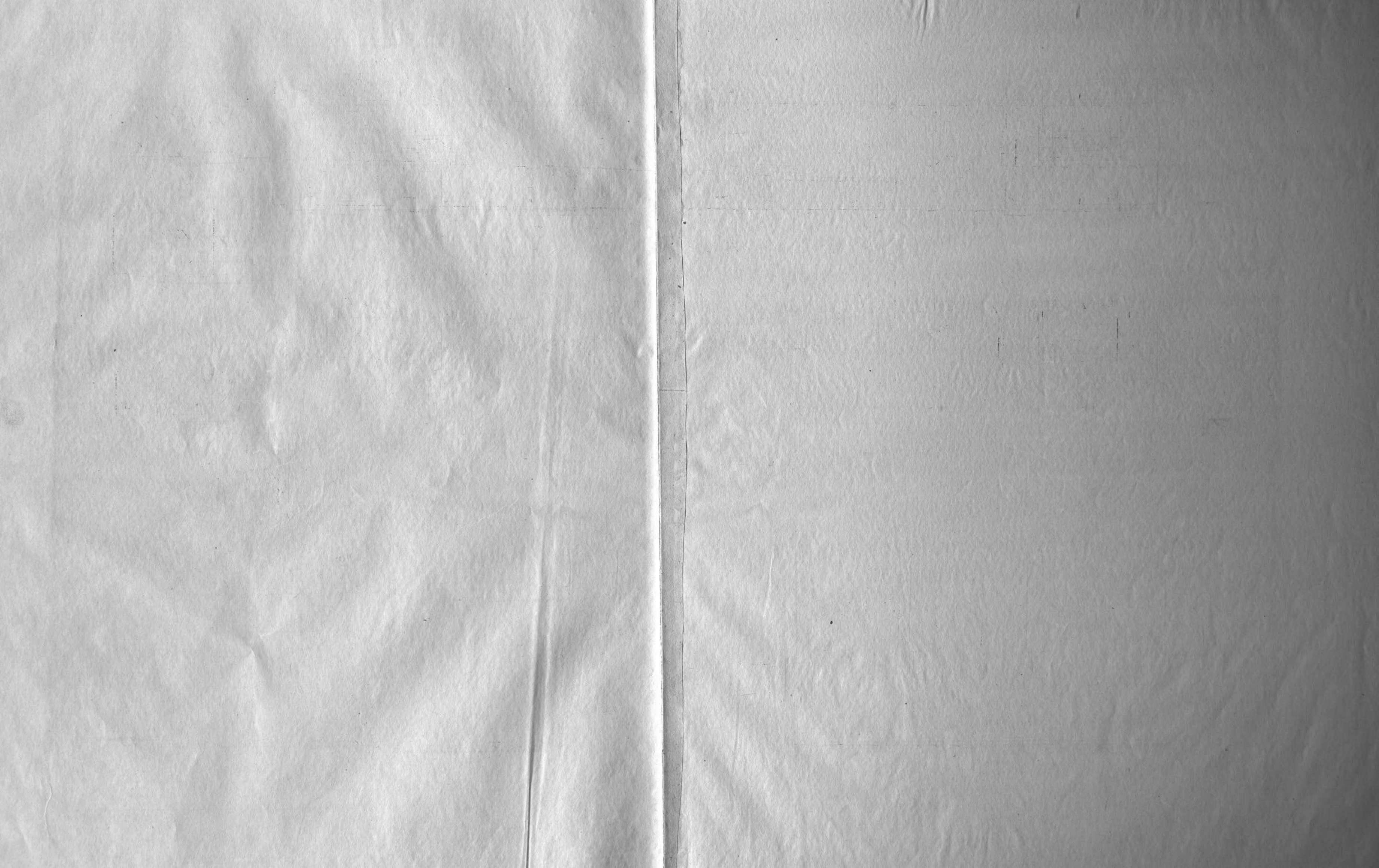


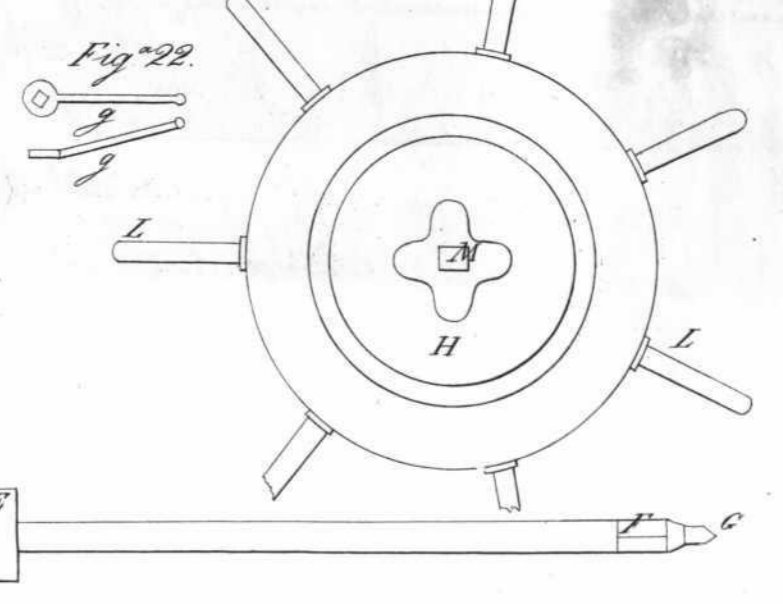
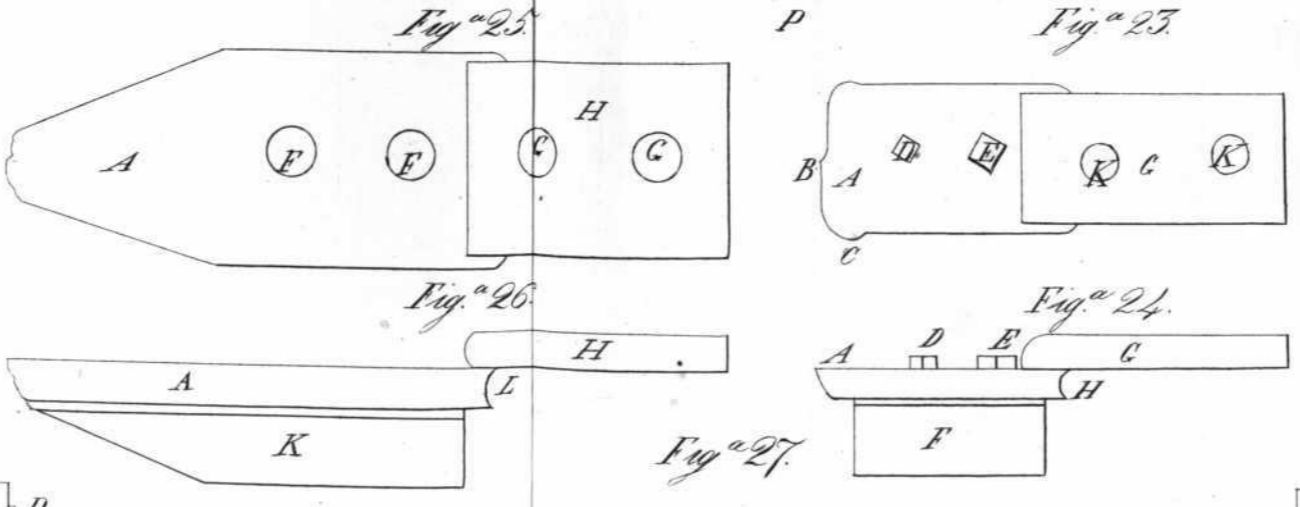
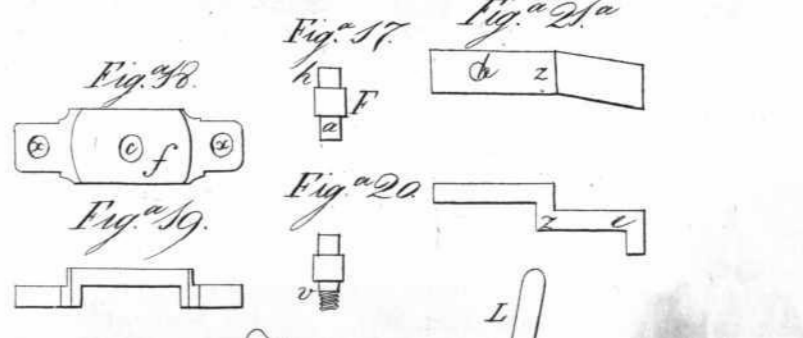
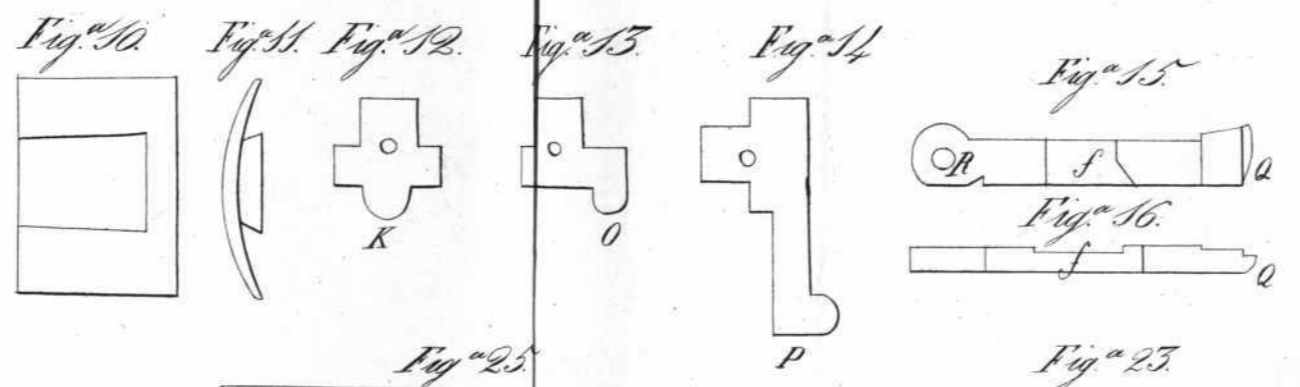
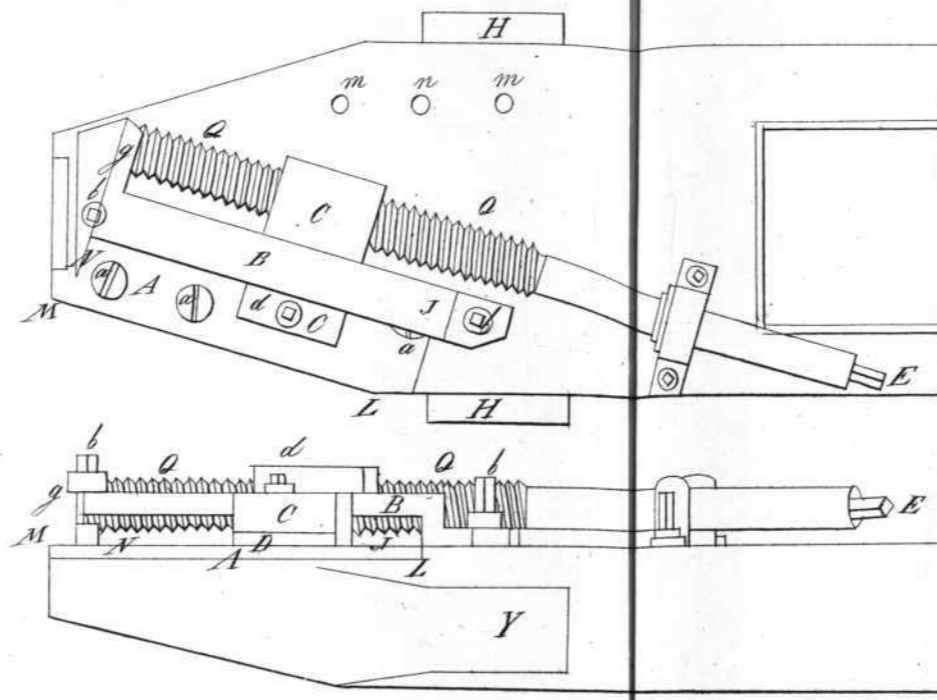
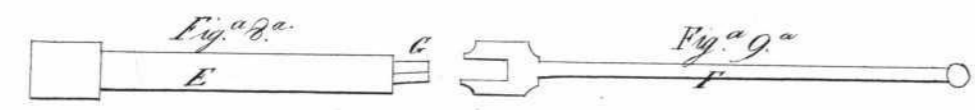
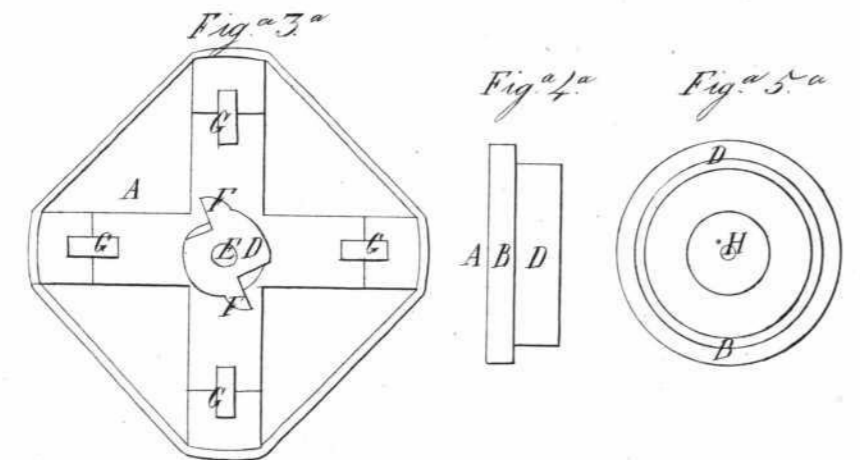
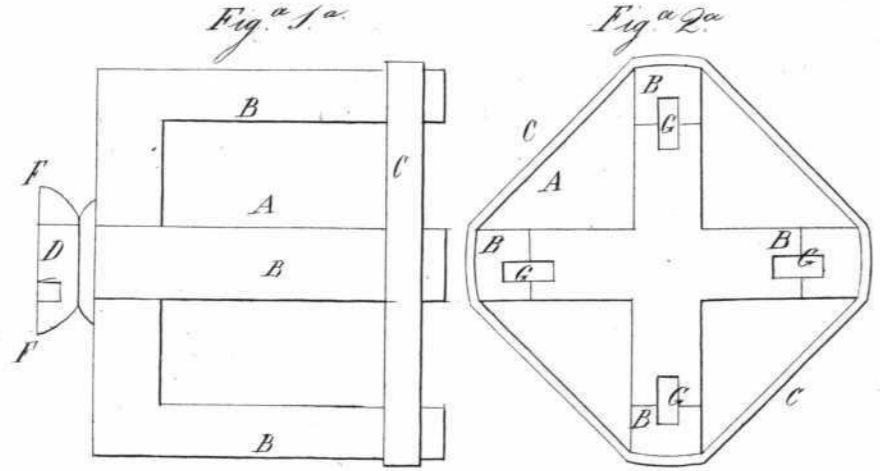




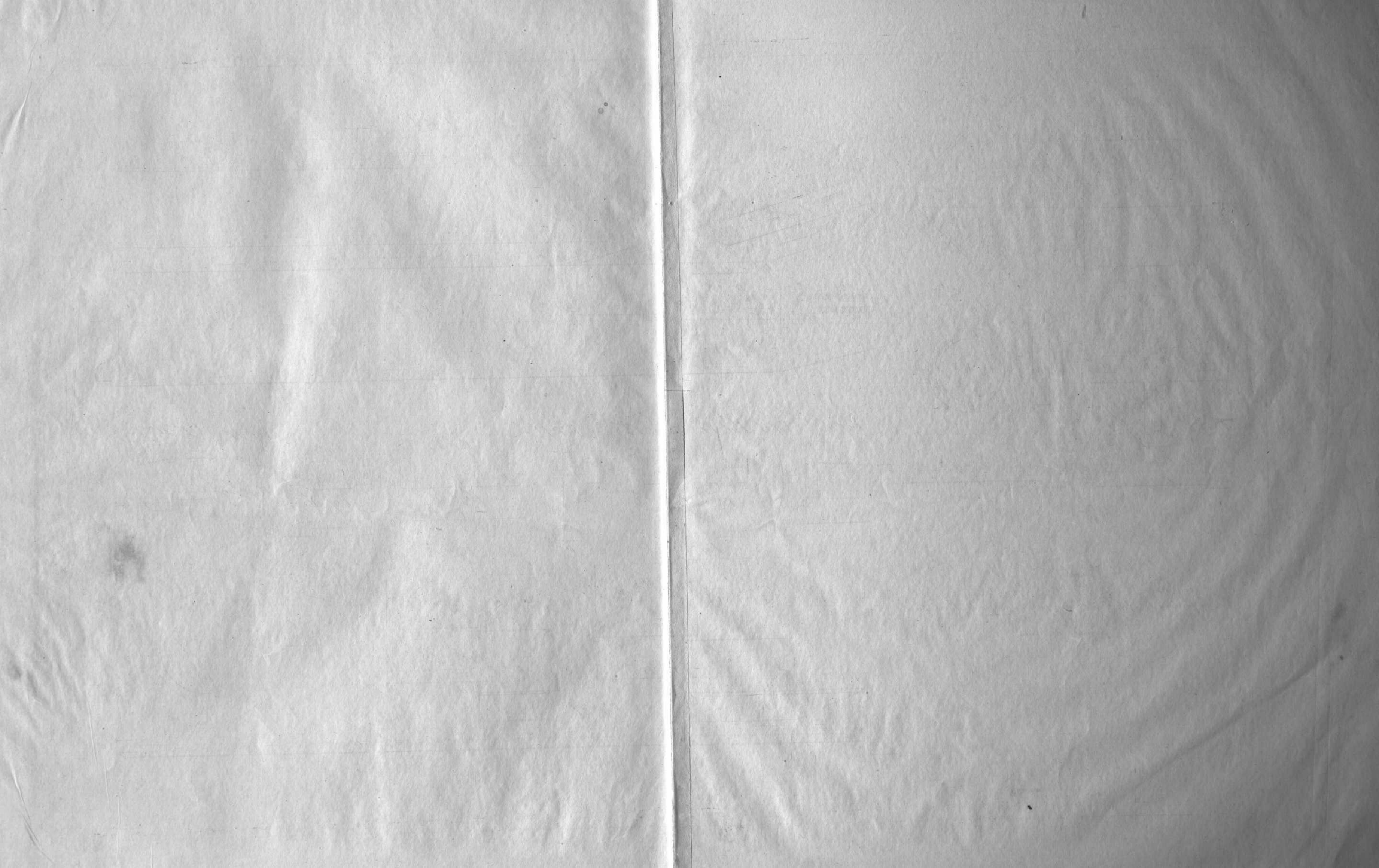
1 2 3 4 5 6 7 Pies Españoles
Escala de las fig. 1, 2, 4, 5, 6, y 7

1 2 3 Pies Españoles
Escala de las fig. 3, 8, 9, 10, 11, y 12.





Escala
 de las figuras 12, 3, 4, 5, 27 y 28, una pulgada por pie de París y à dos
 pulgadas las demas.



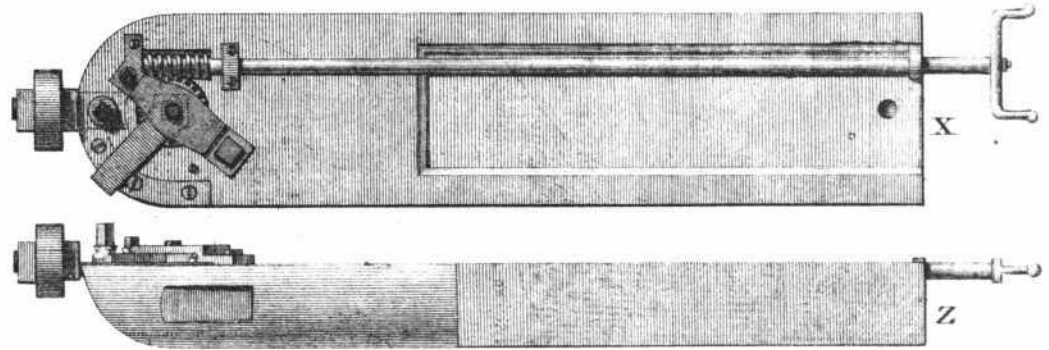
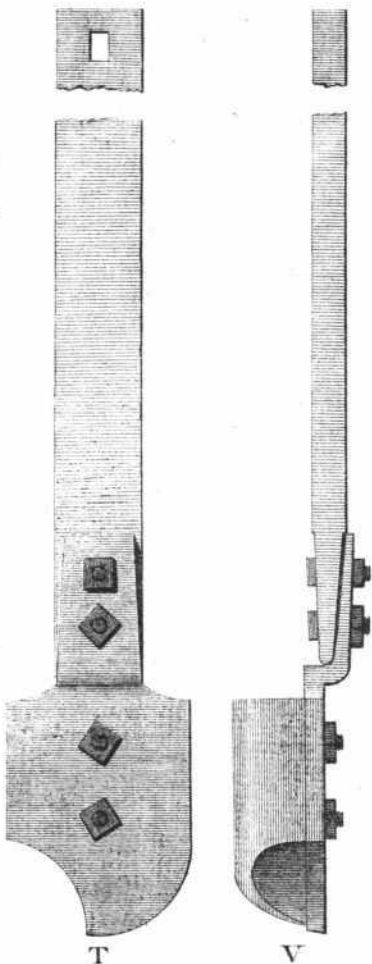
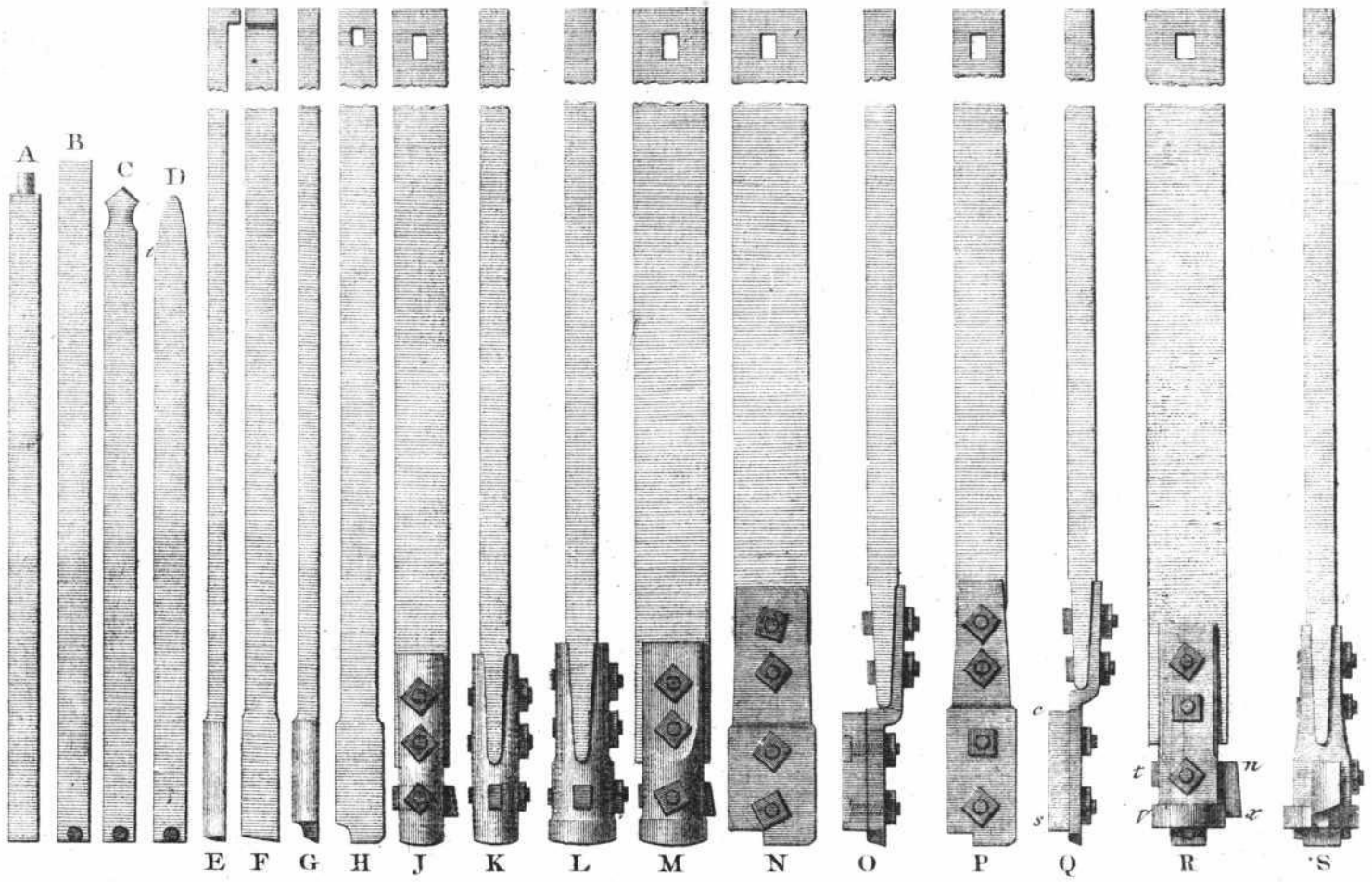


Figura 2.^a

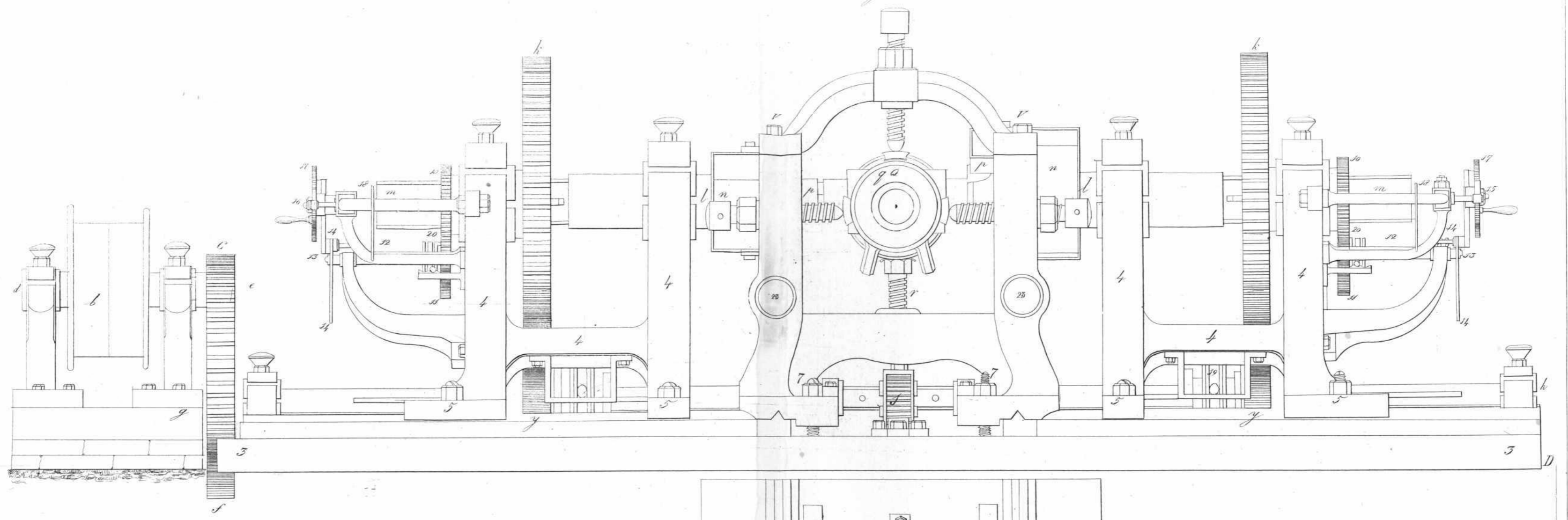
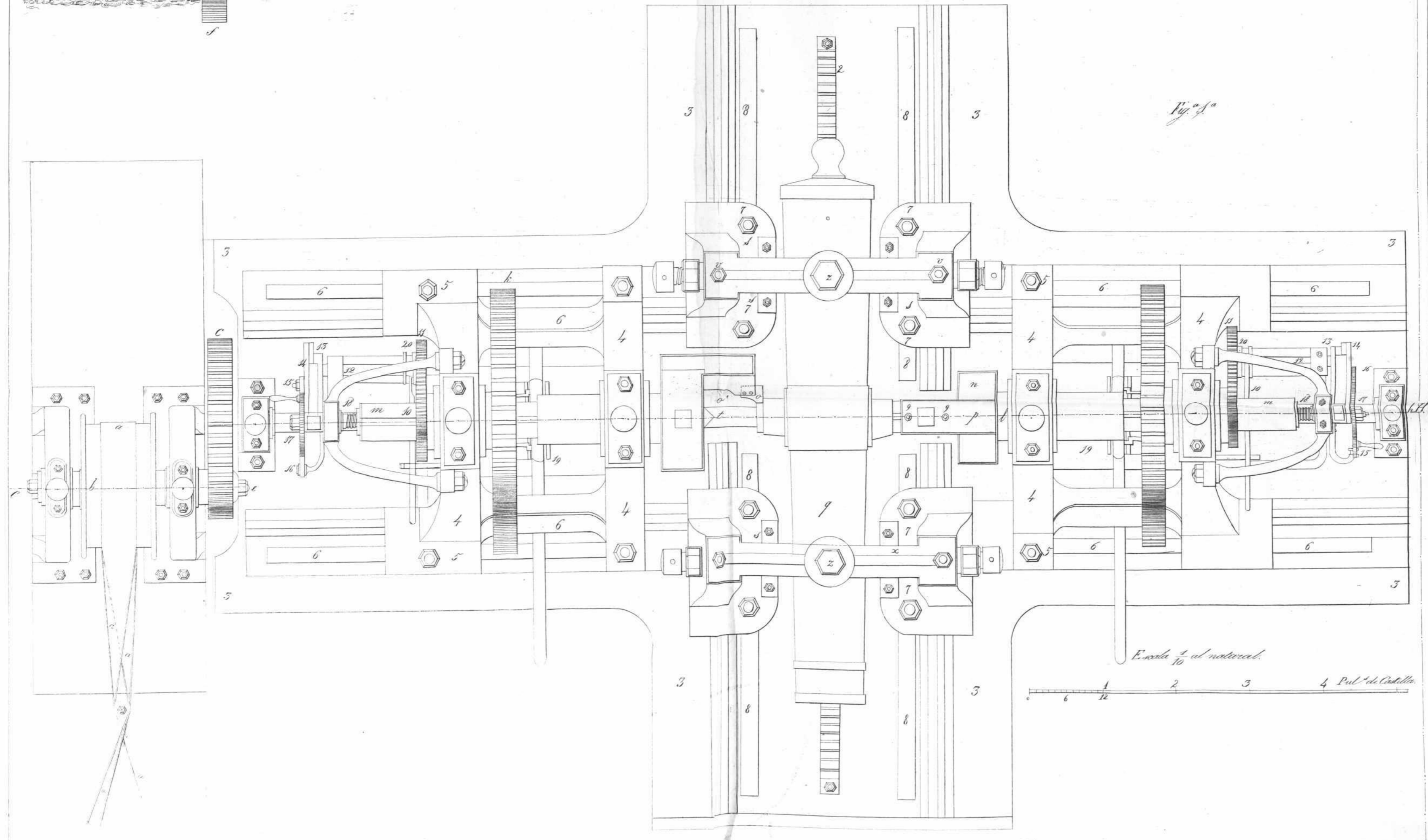
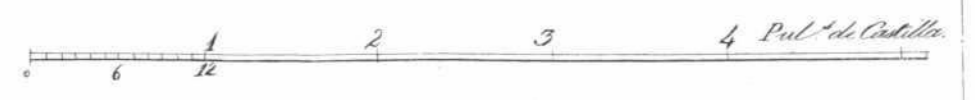


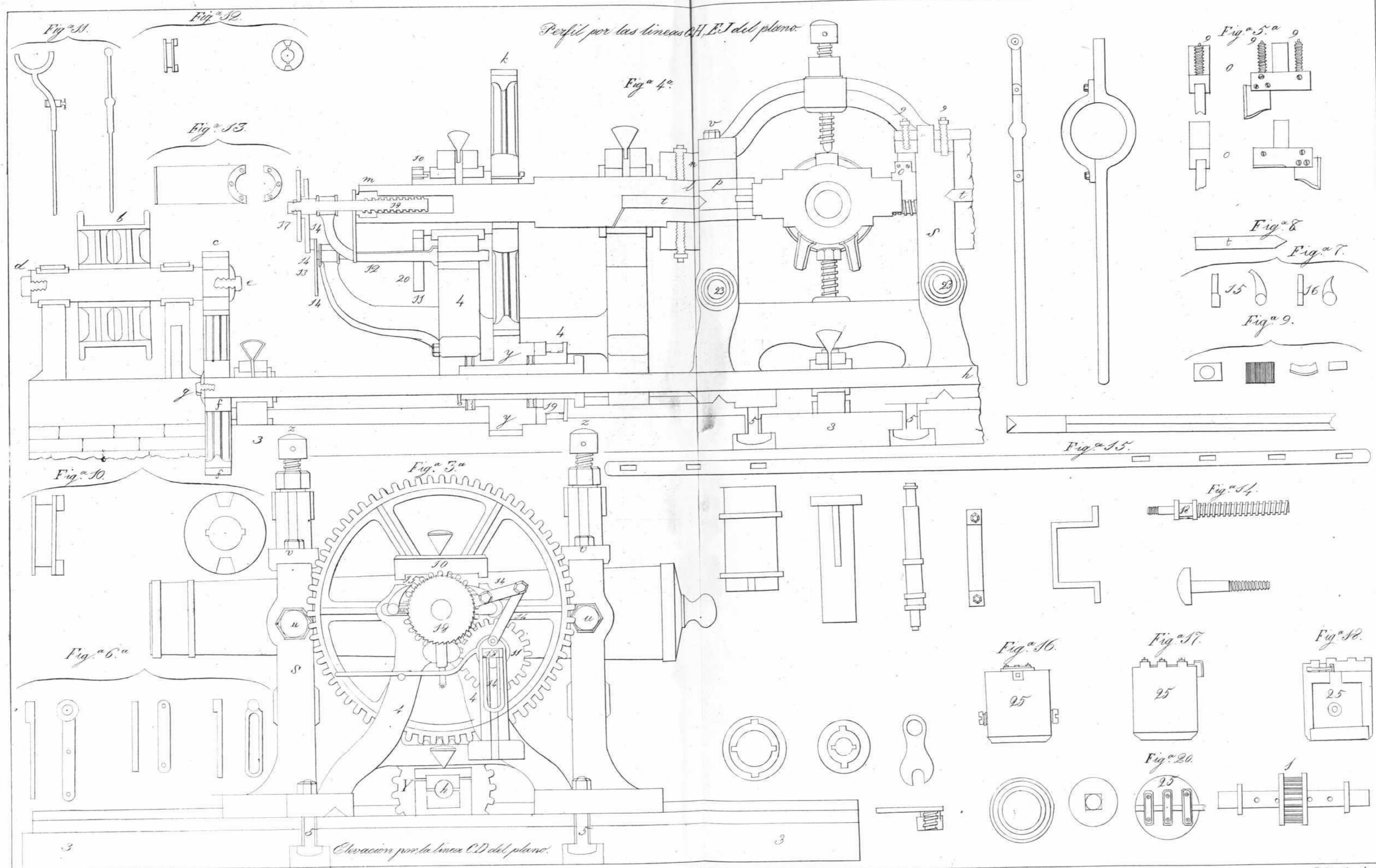
Fig. 3.^a



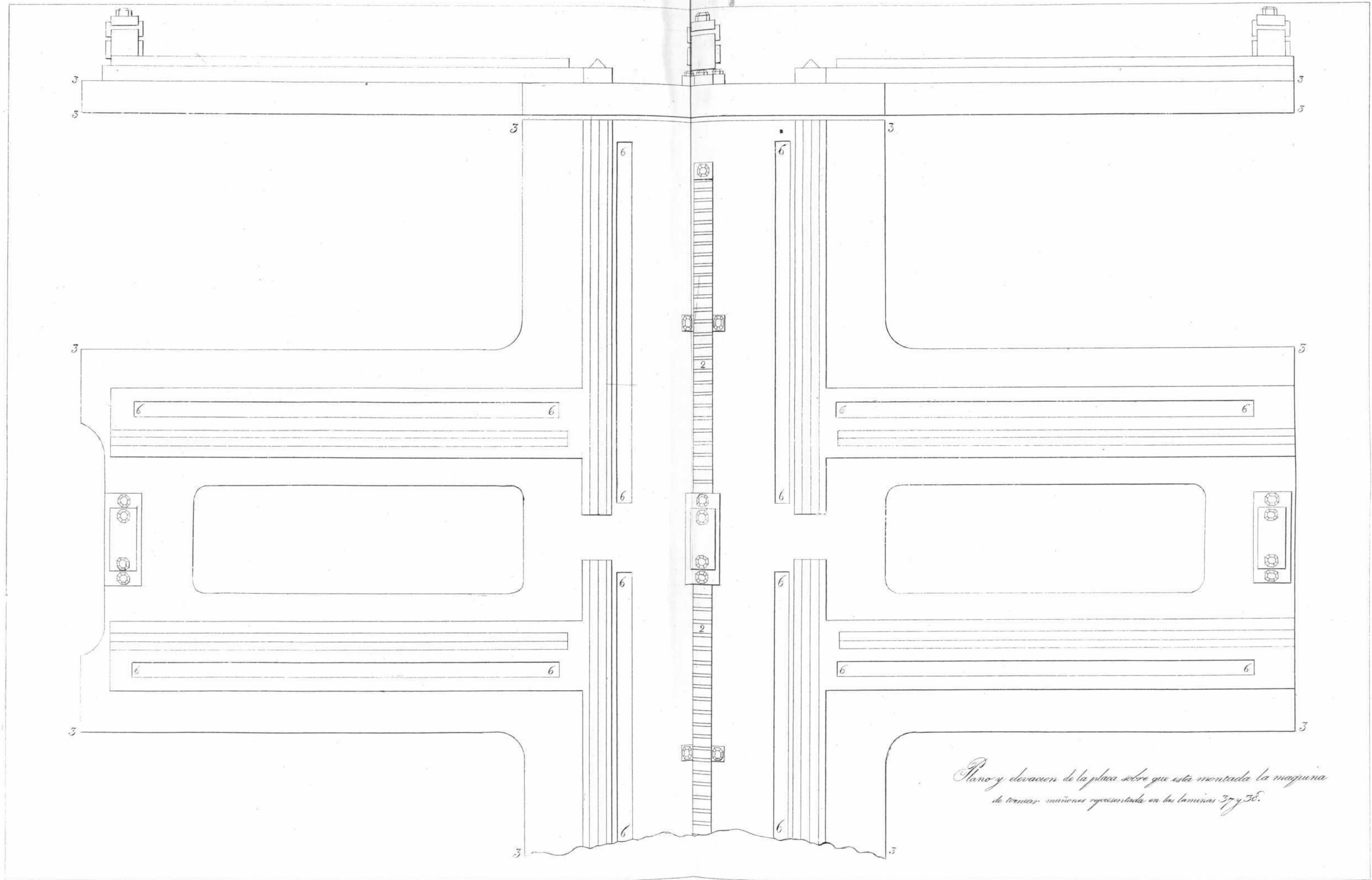
Escala $\frac{1}{10}$ al natural.



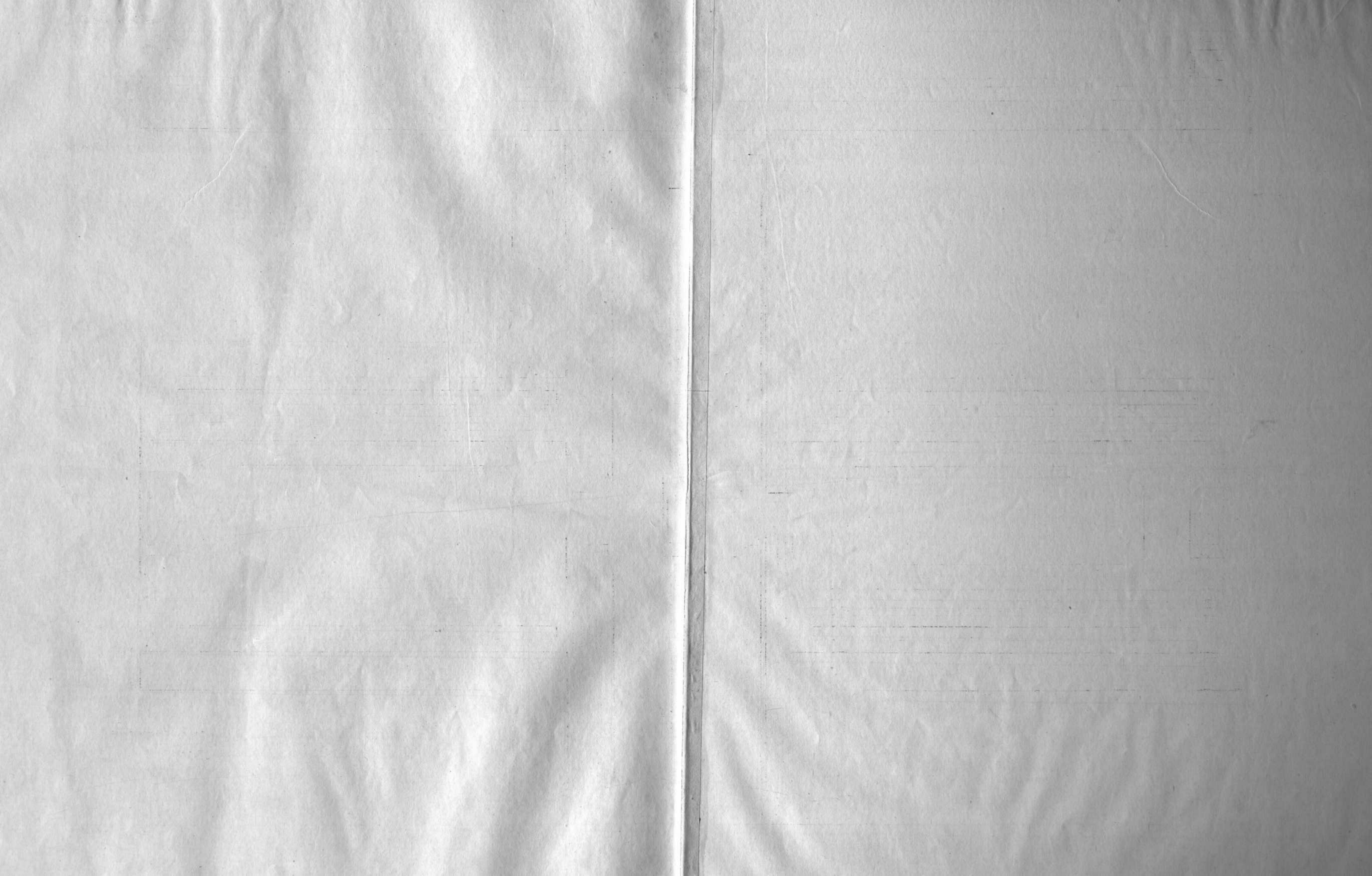


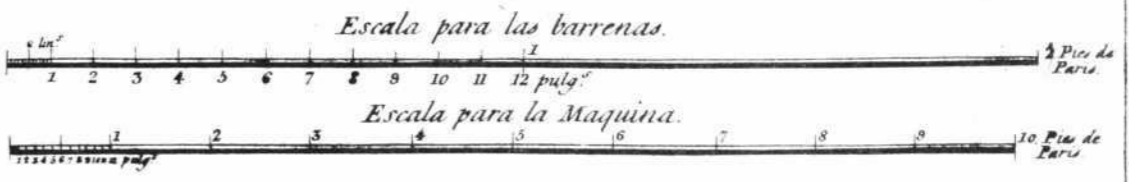
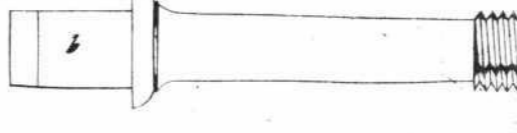
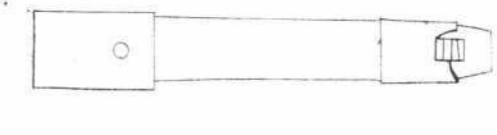
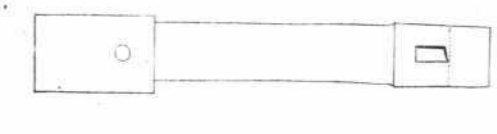
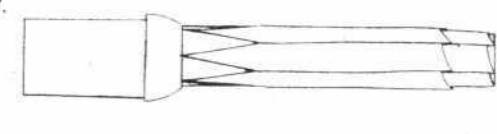
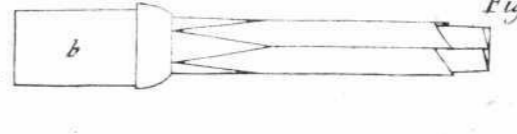
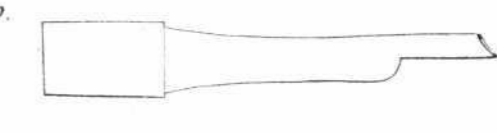
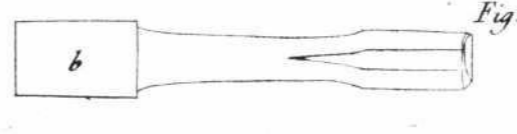
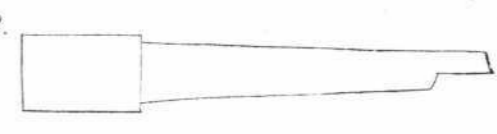
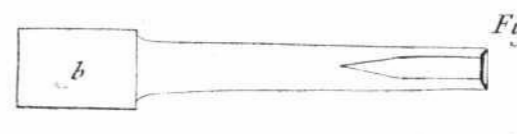
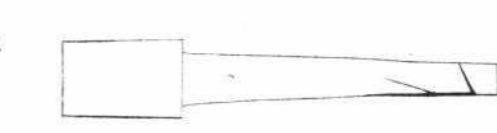
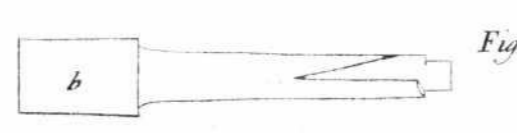
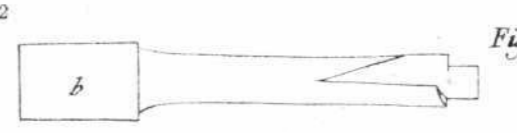
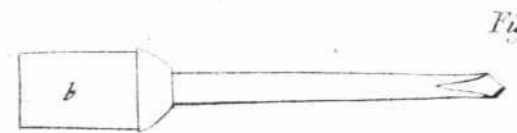
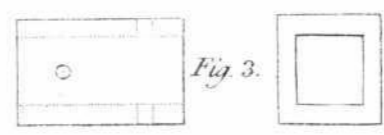
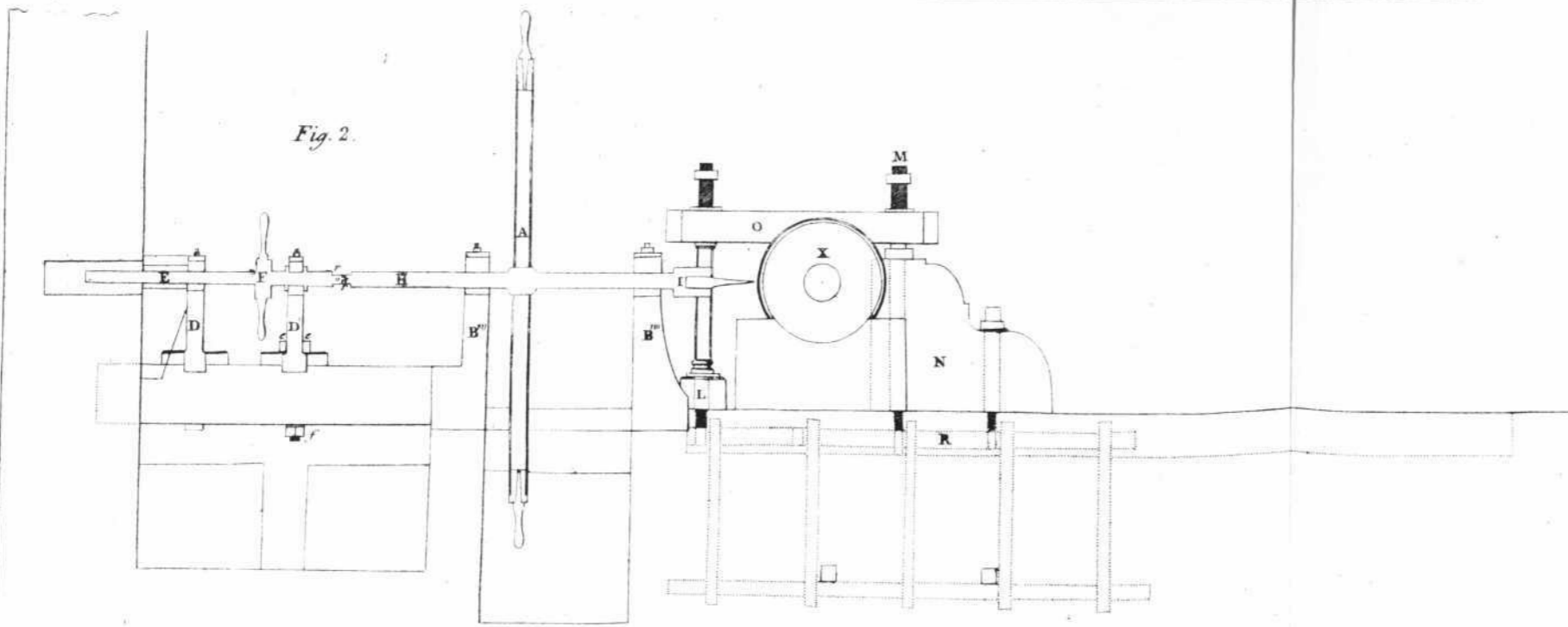
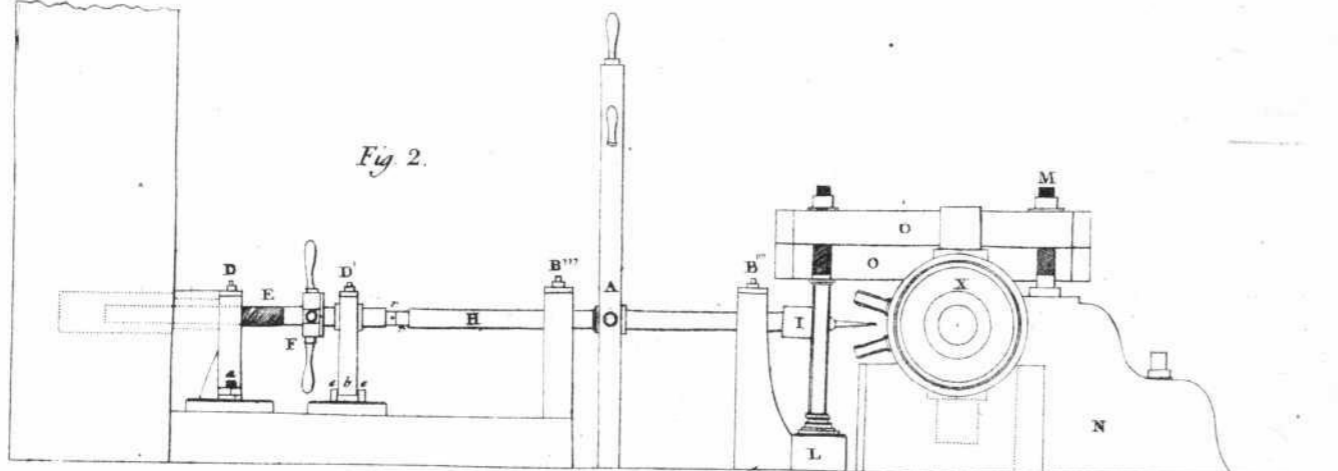
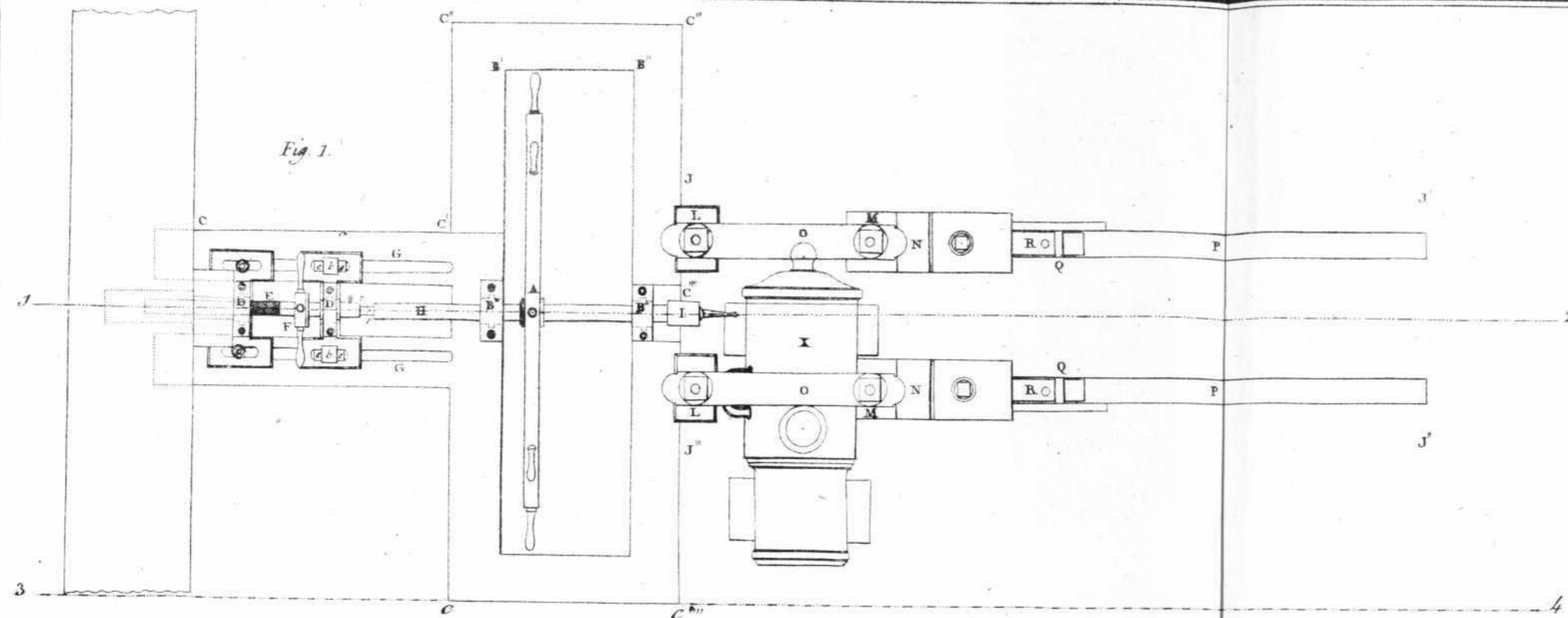


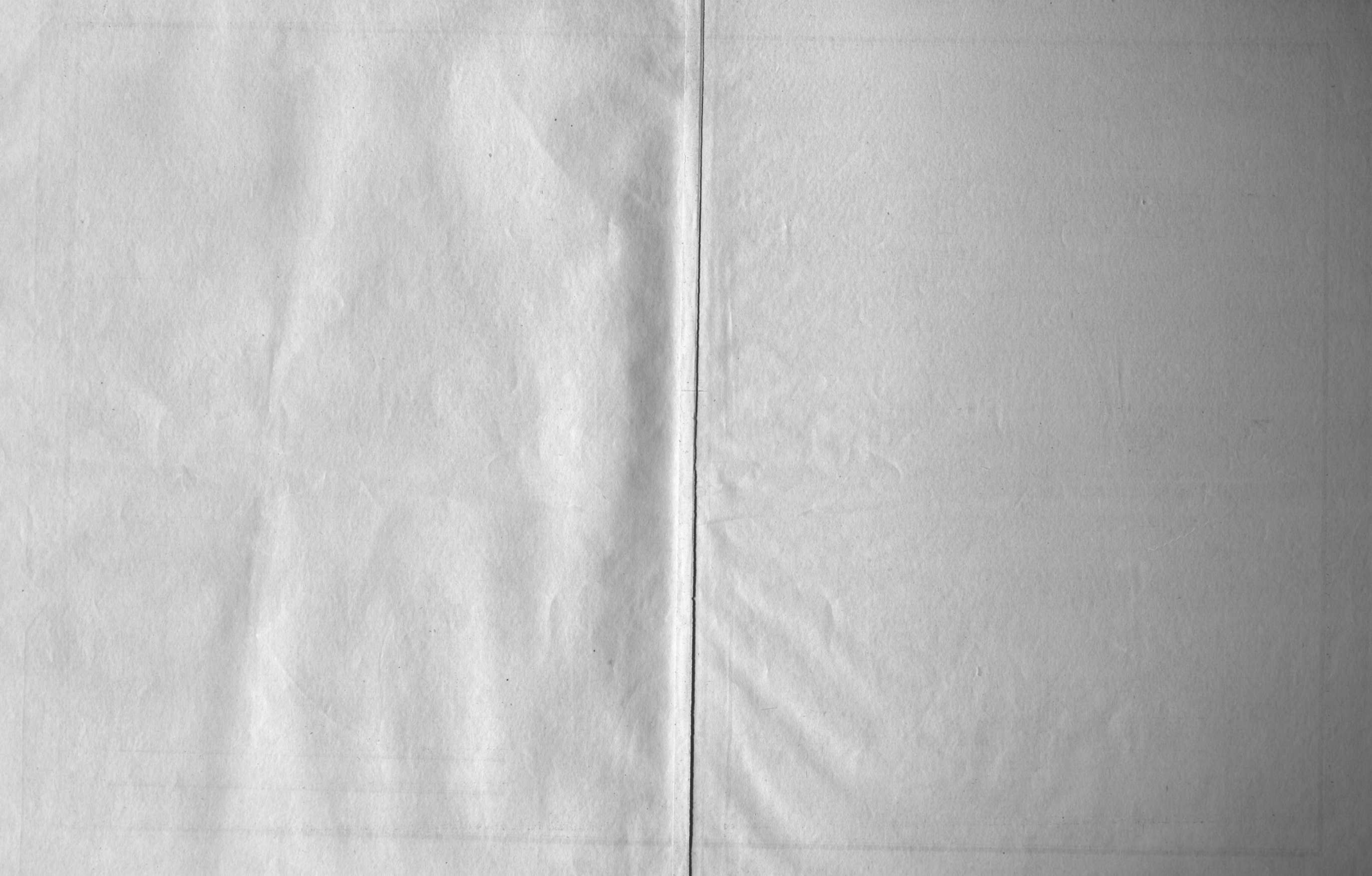




Plano y elevacion de la plaza sobre que esta montada la maquina de truenos, misionos representada en las laminas 37 y 38.







Aguja. Fig. 1.



Gato.



Cruzetas, ò Estrellas.



F. stampa.



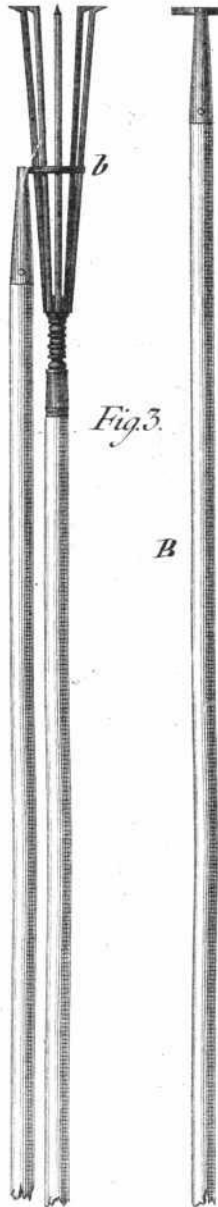
Atacador.



Fig. 2.



Fig. 3.



D

D

Fig. 4.

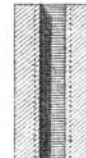
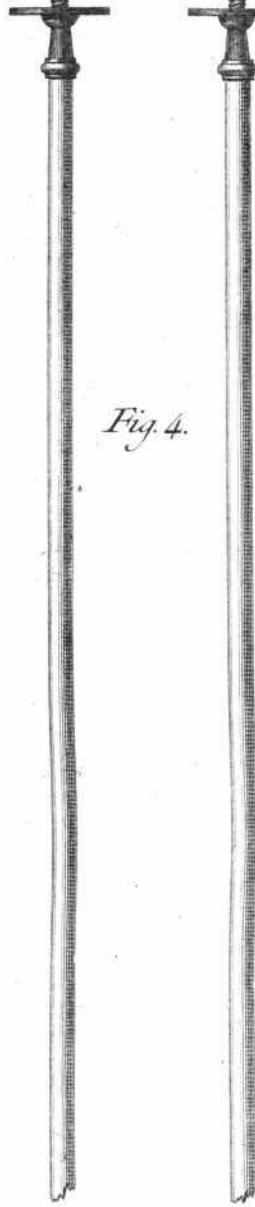
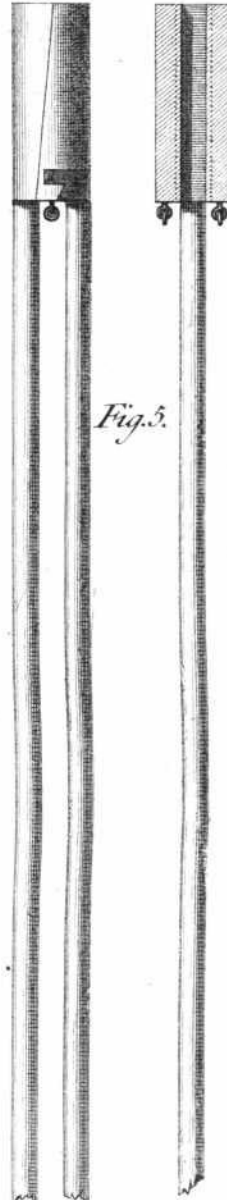


Fig. 5.

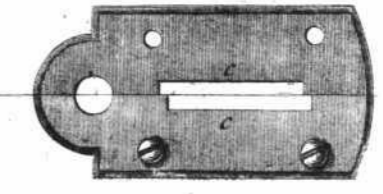
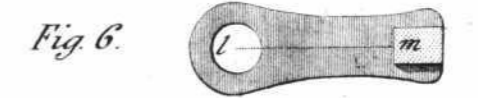
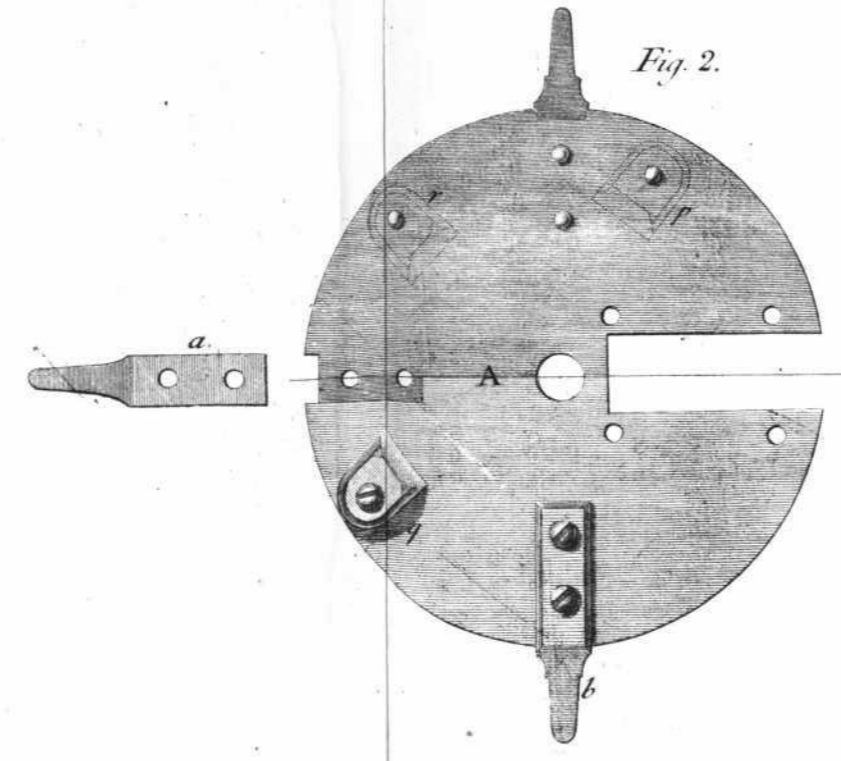
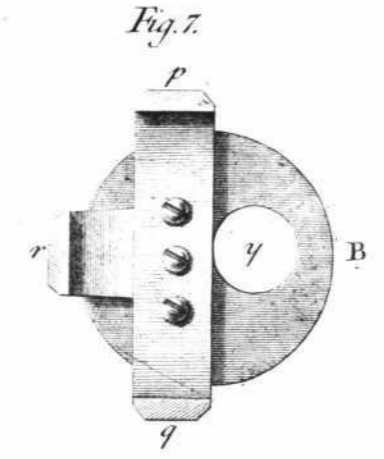
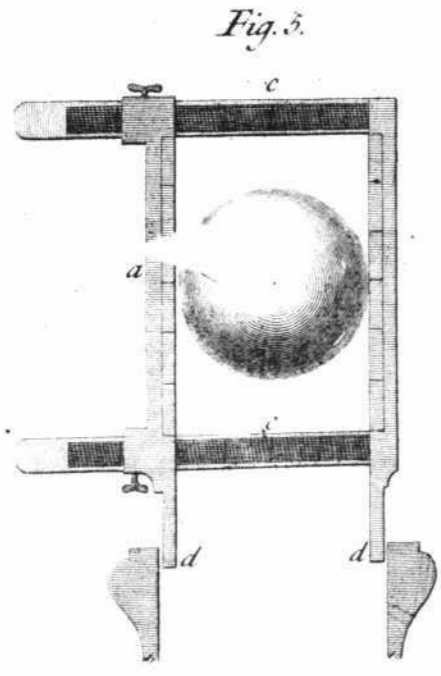
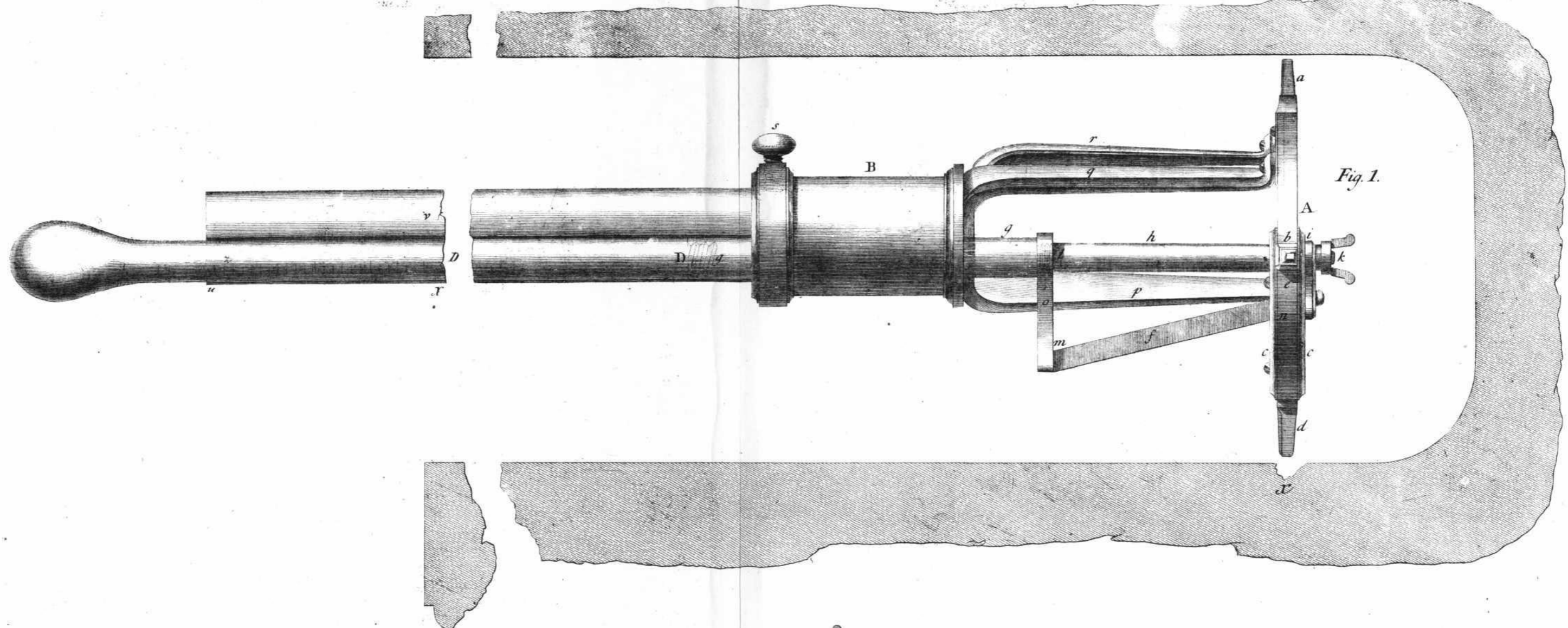


Sonda.

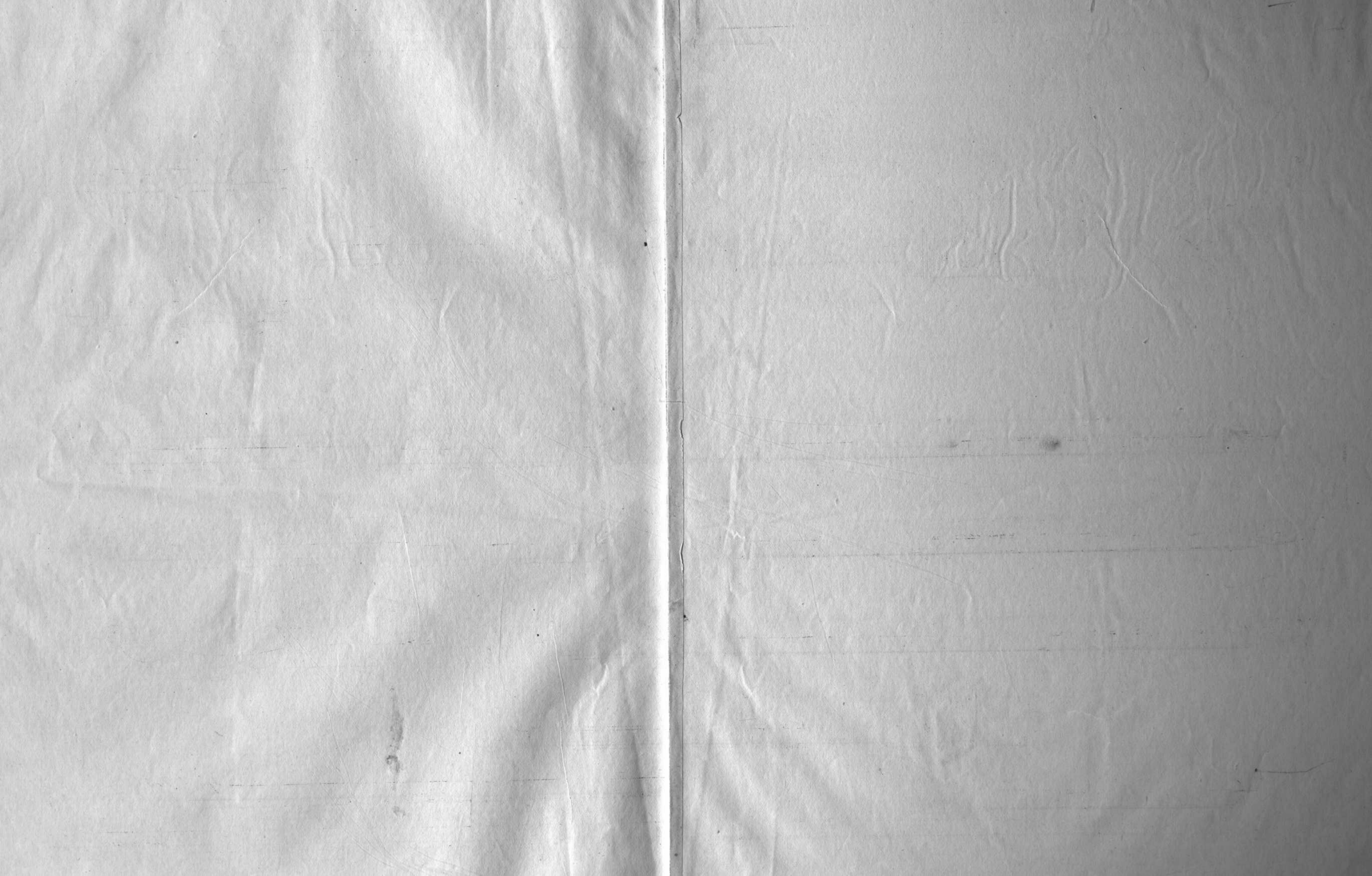


Fig. 6.









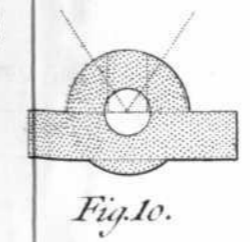
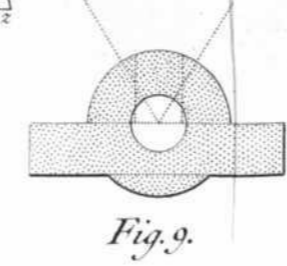
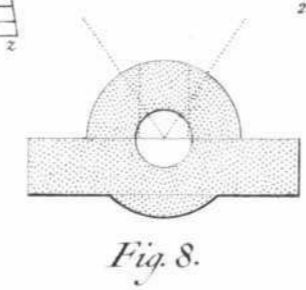
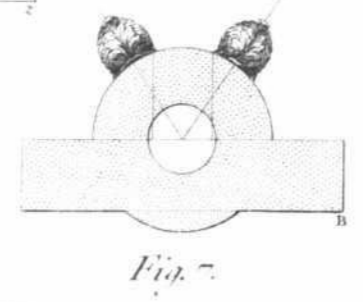
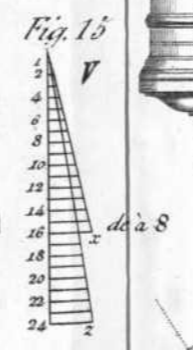
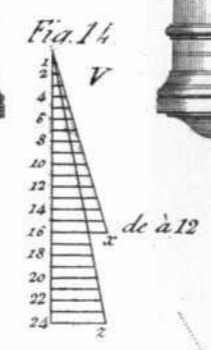
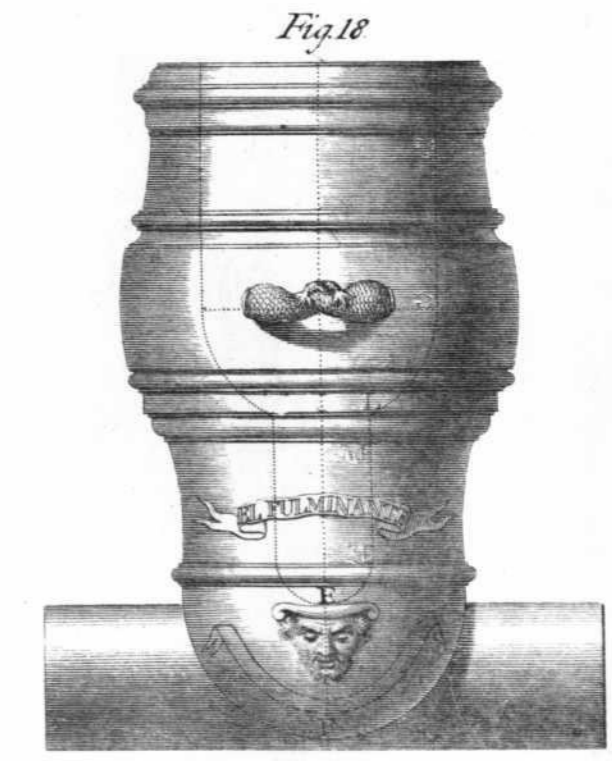
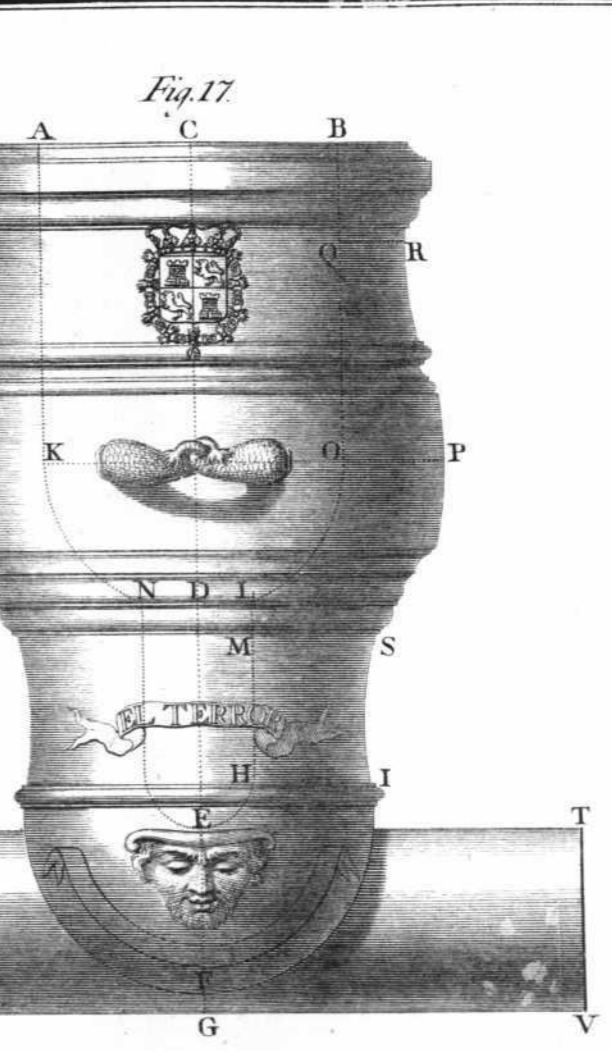
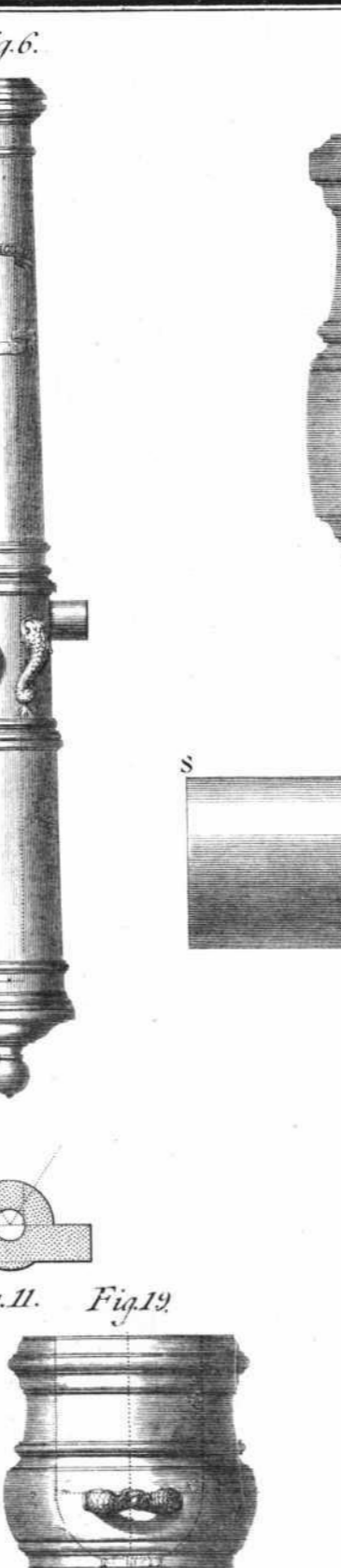
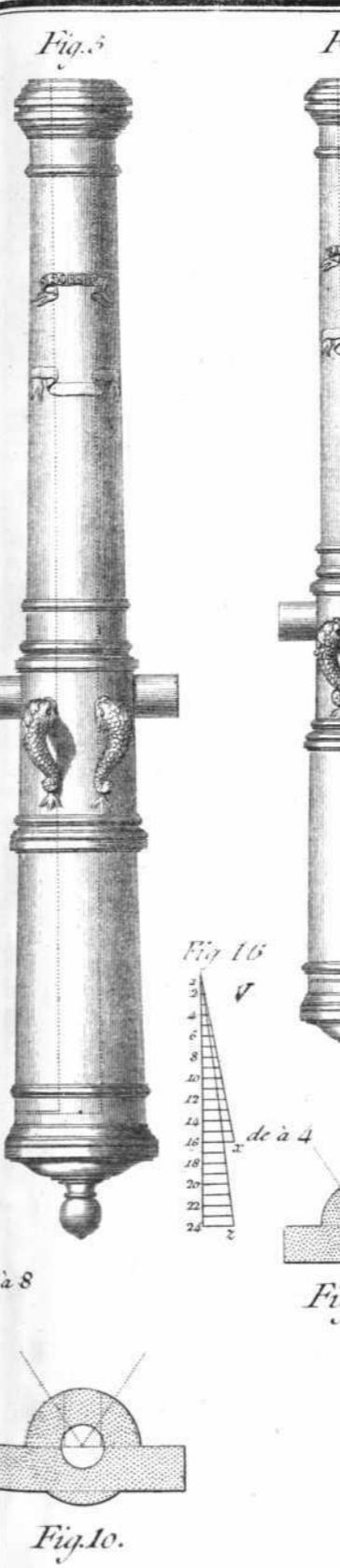
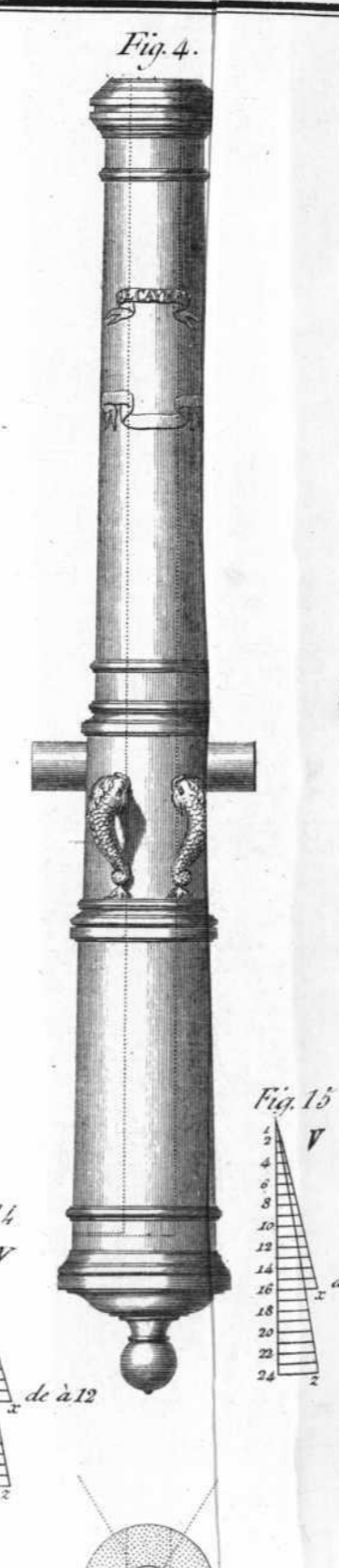
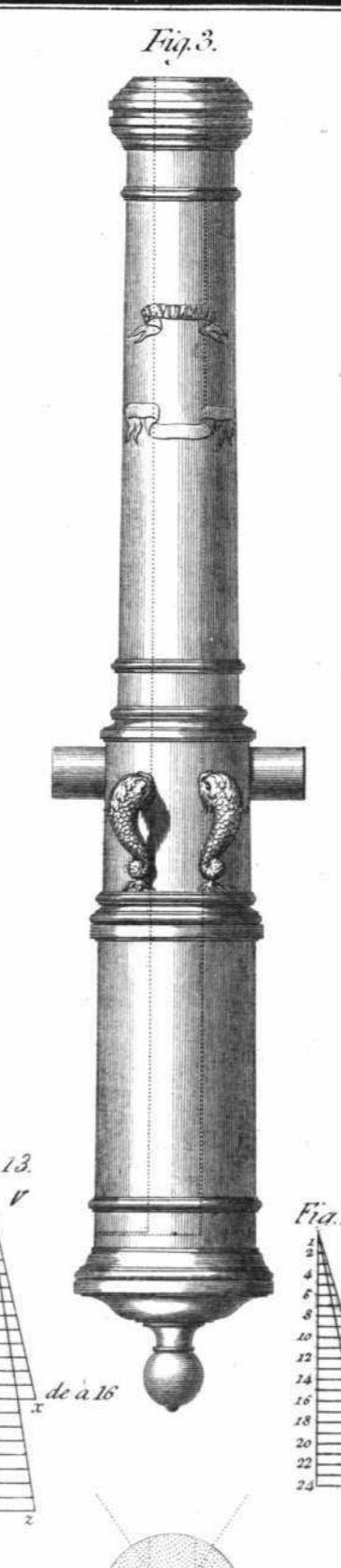
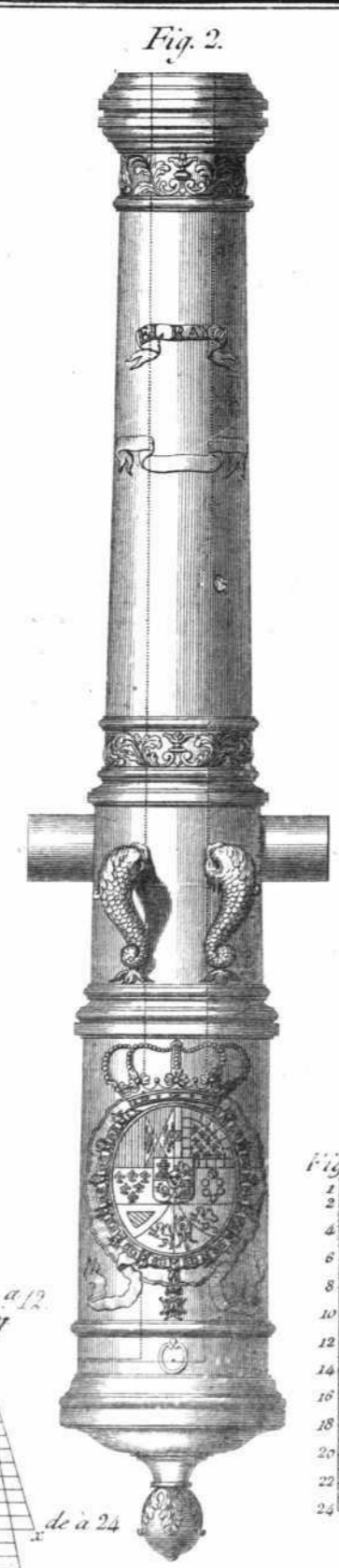
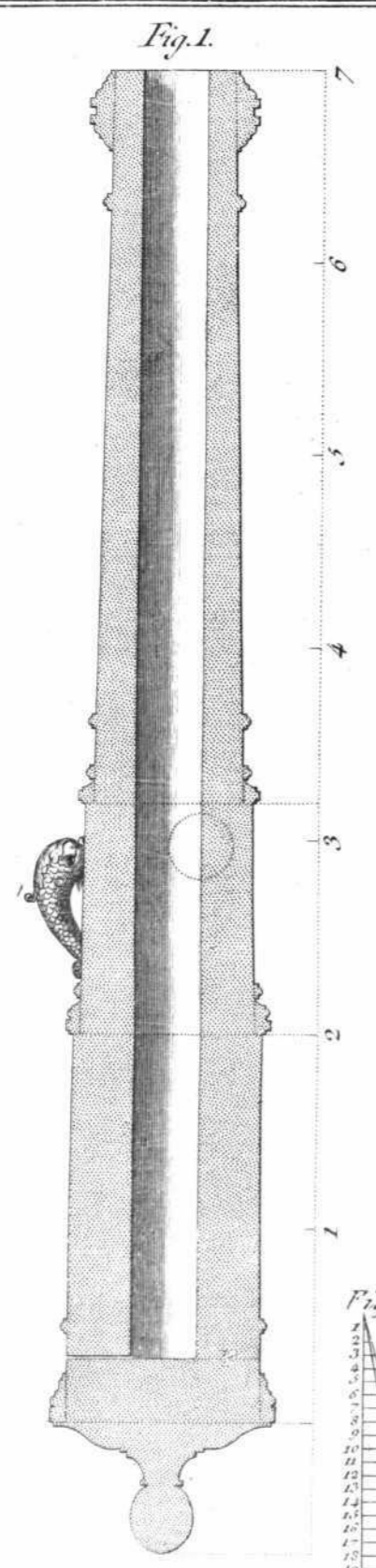
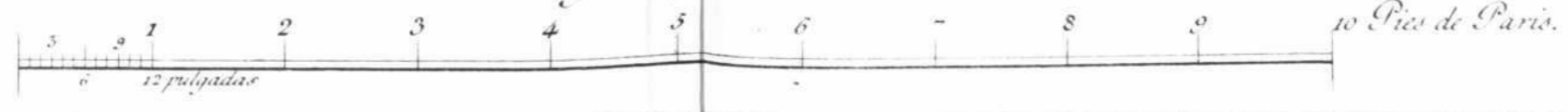


Fig. 11. Fig. 19.



Escala para los Cañones.

10 Pies de Paris.

Escala para los Morteros.

4 Pies de Paris.



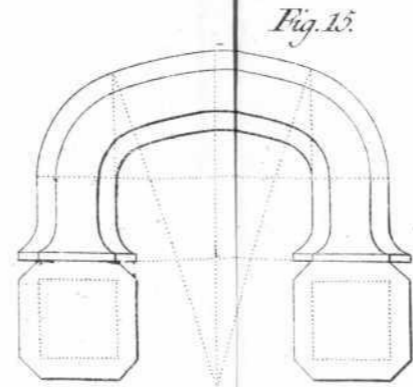
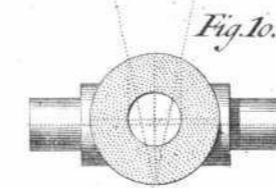
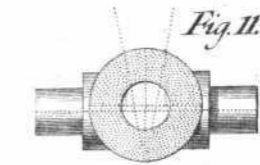
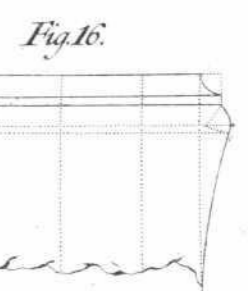
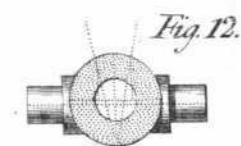
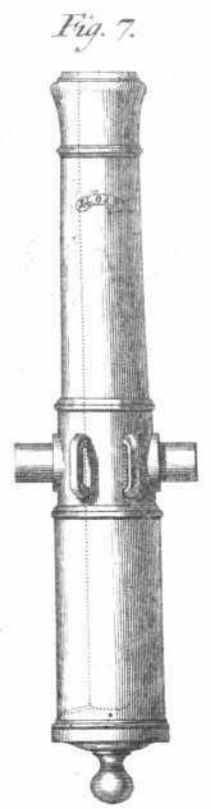
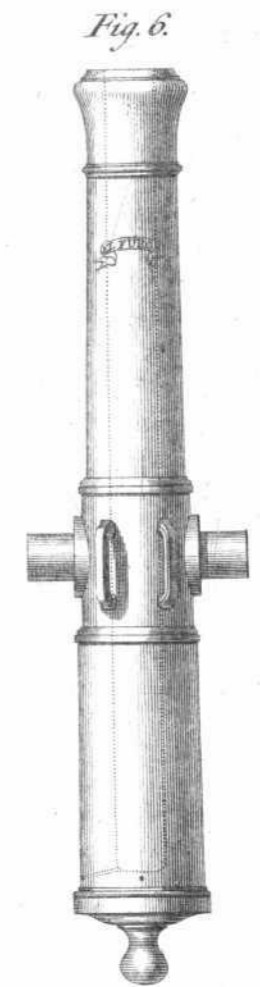
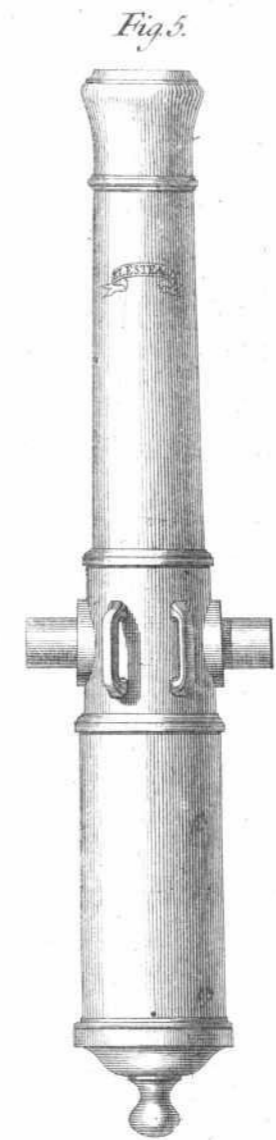
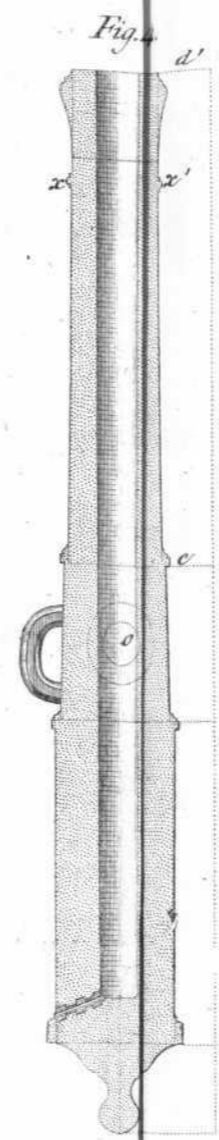
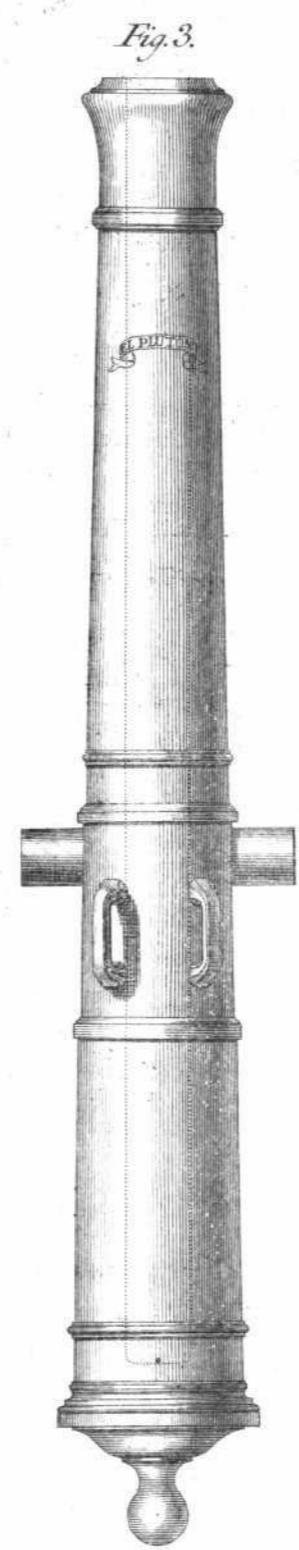
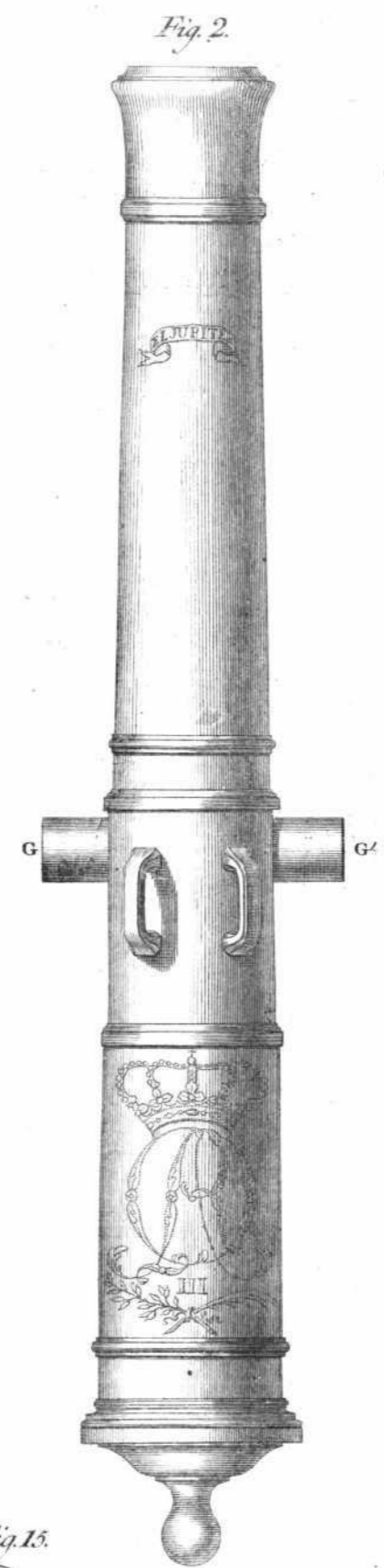
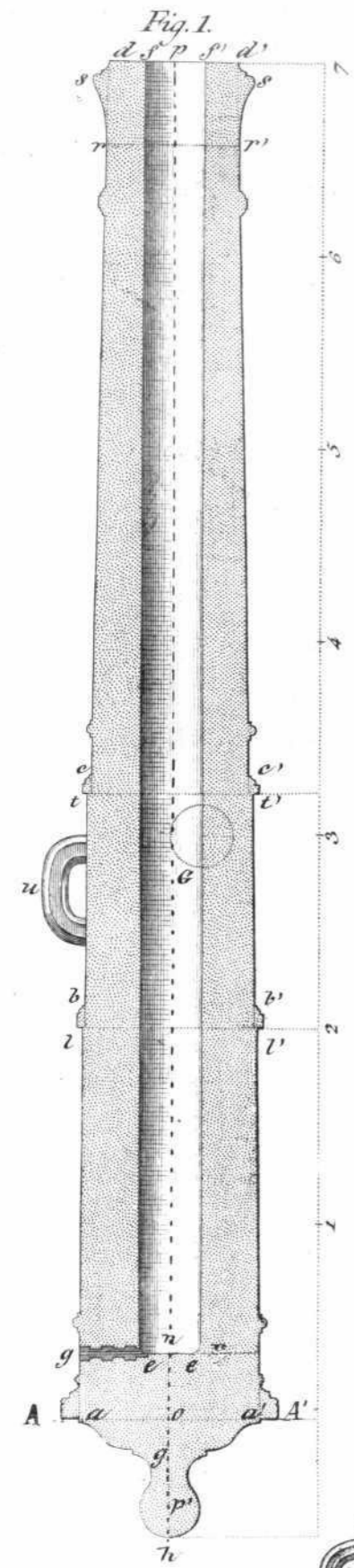


Fig. 15.

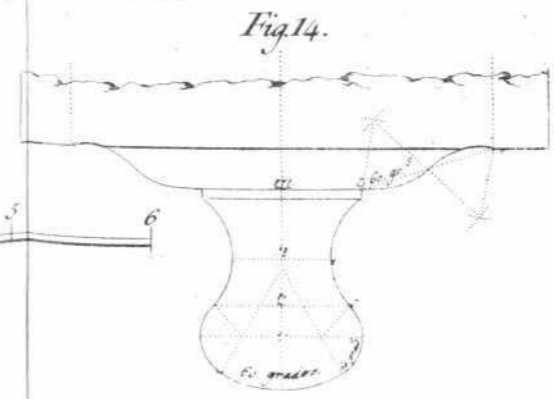


Fig. 14.

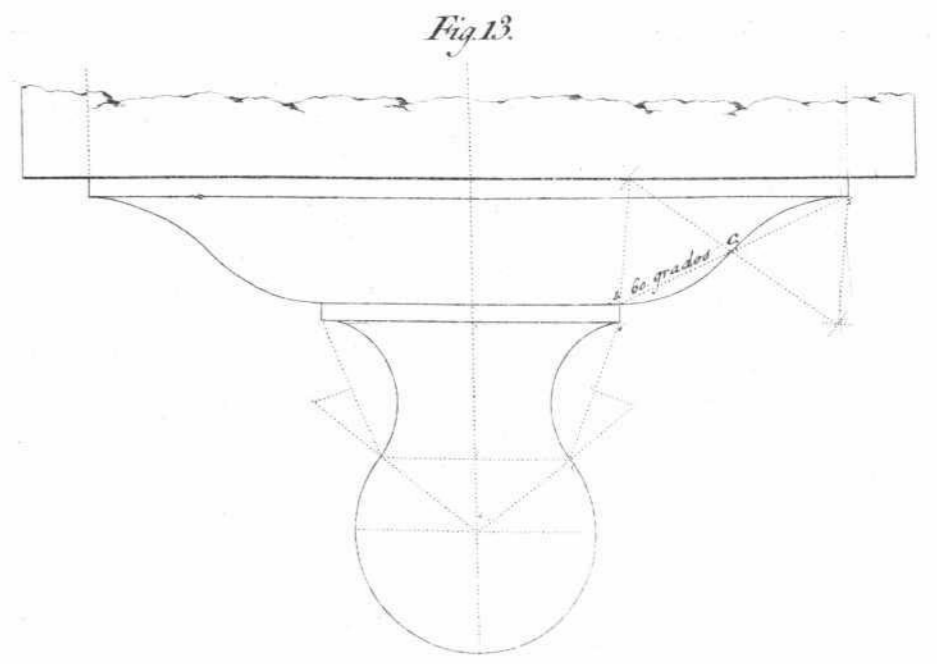


Fig. 13.



Fig. 15.

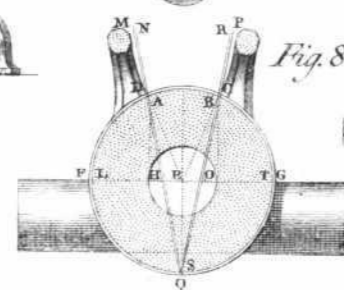


Fig. 8.

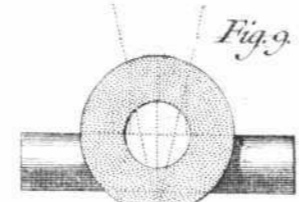


Fig. 9.

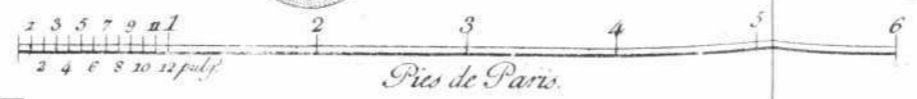




Fig.^a 1^a

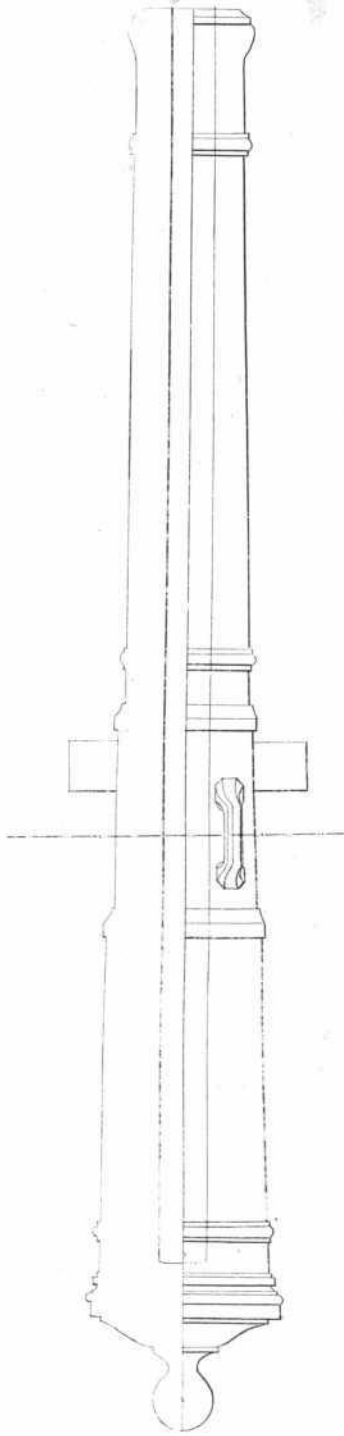


Fig.^a 2^a

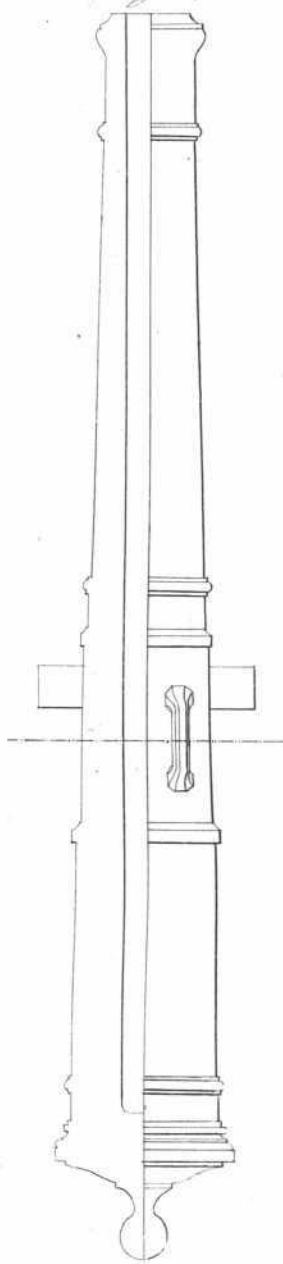
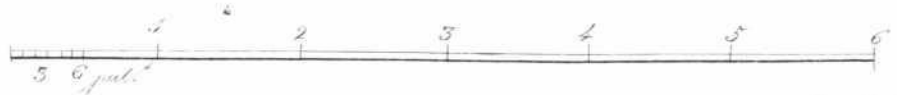
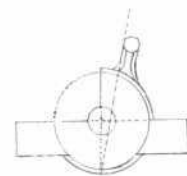
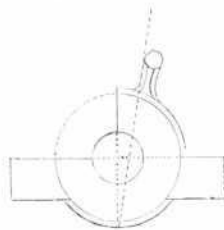
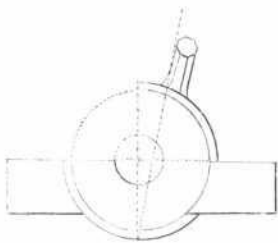
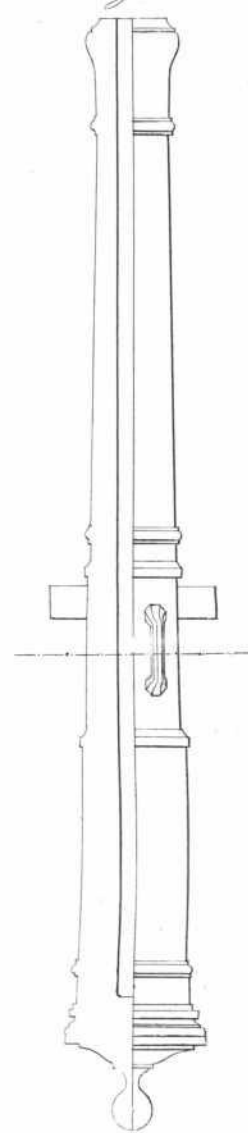


Fig.^a 3^a



Pres de Paris.

Fig.^o 2.^o

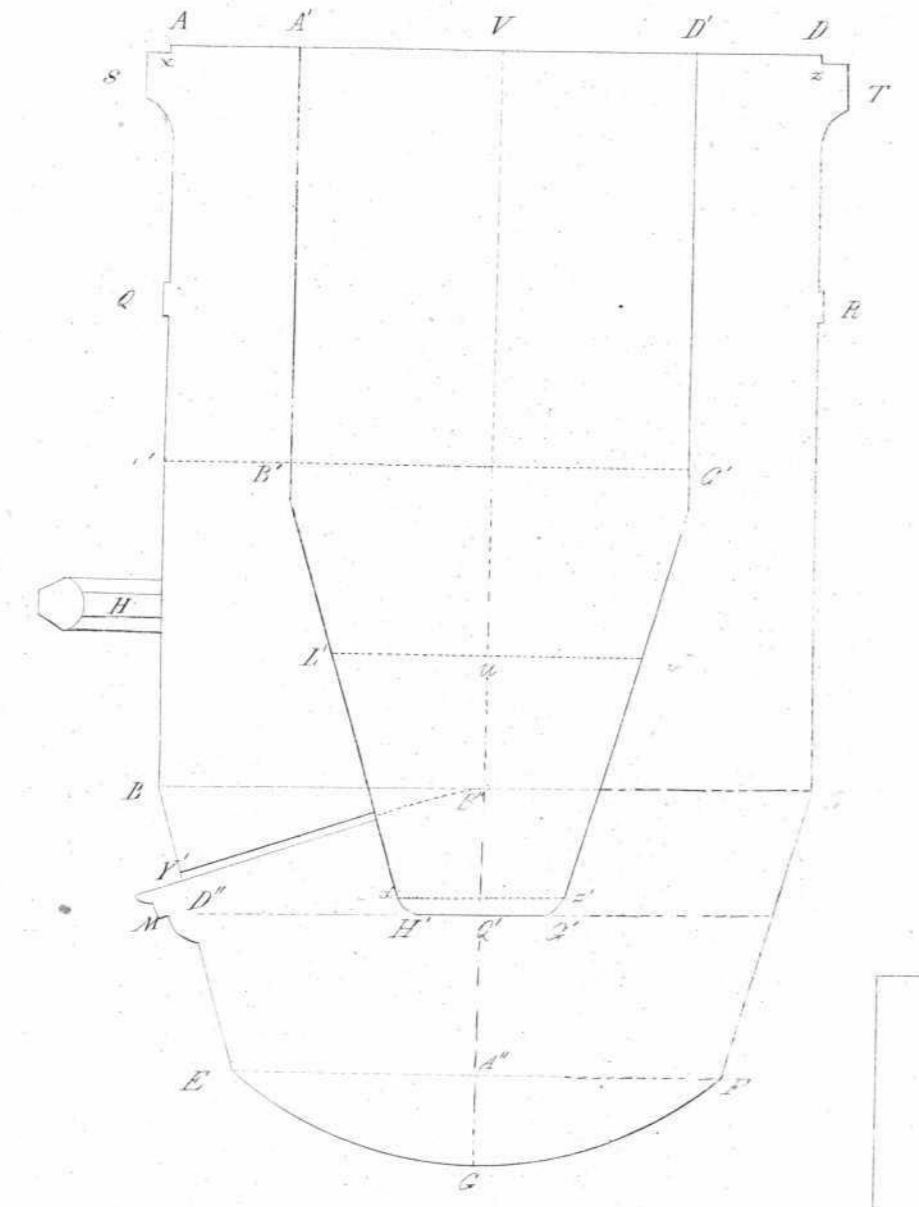


Fig.^o 3.^o

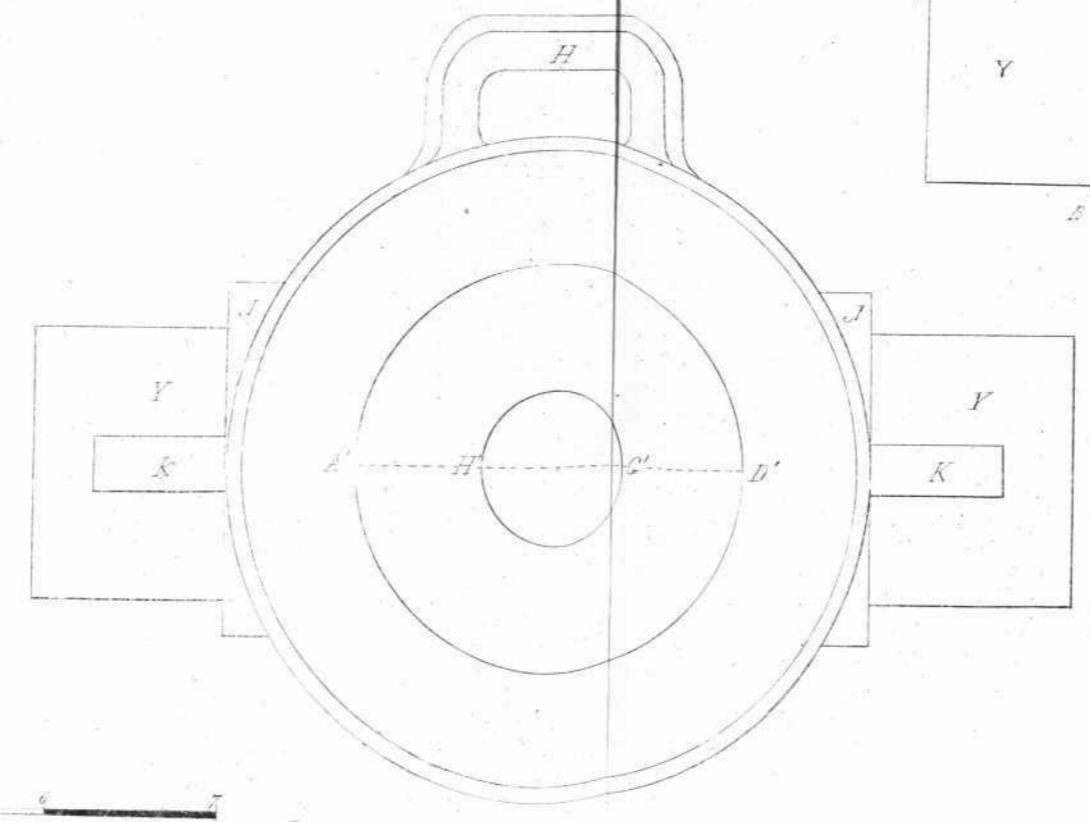
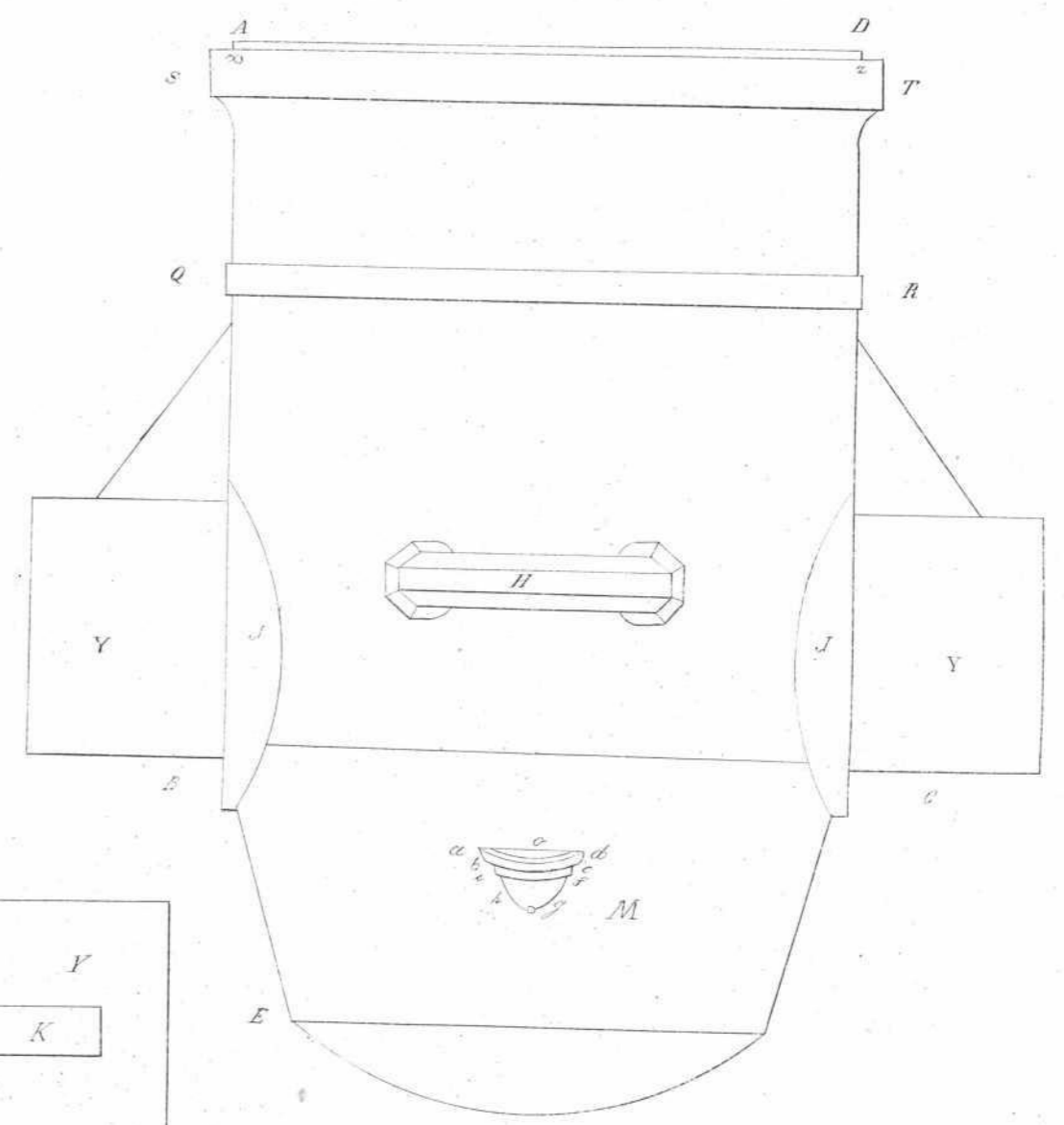


Fig.^o 4.^o



Cada de 2 pulgadas por pie.



Plus de Castilla.



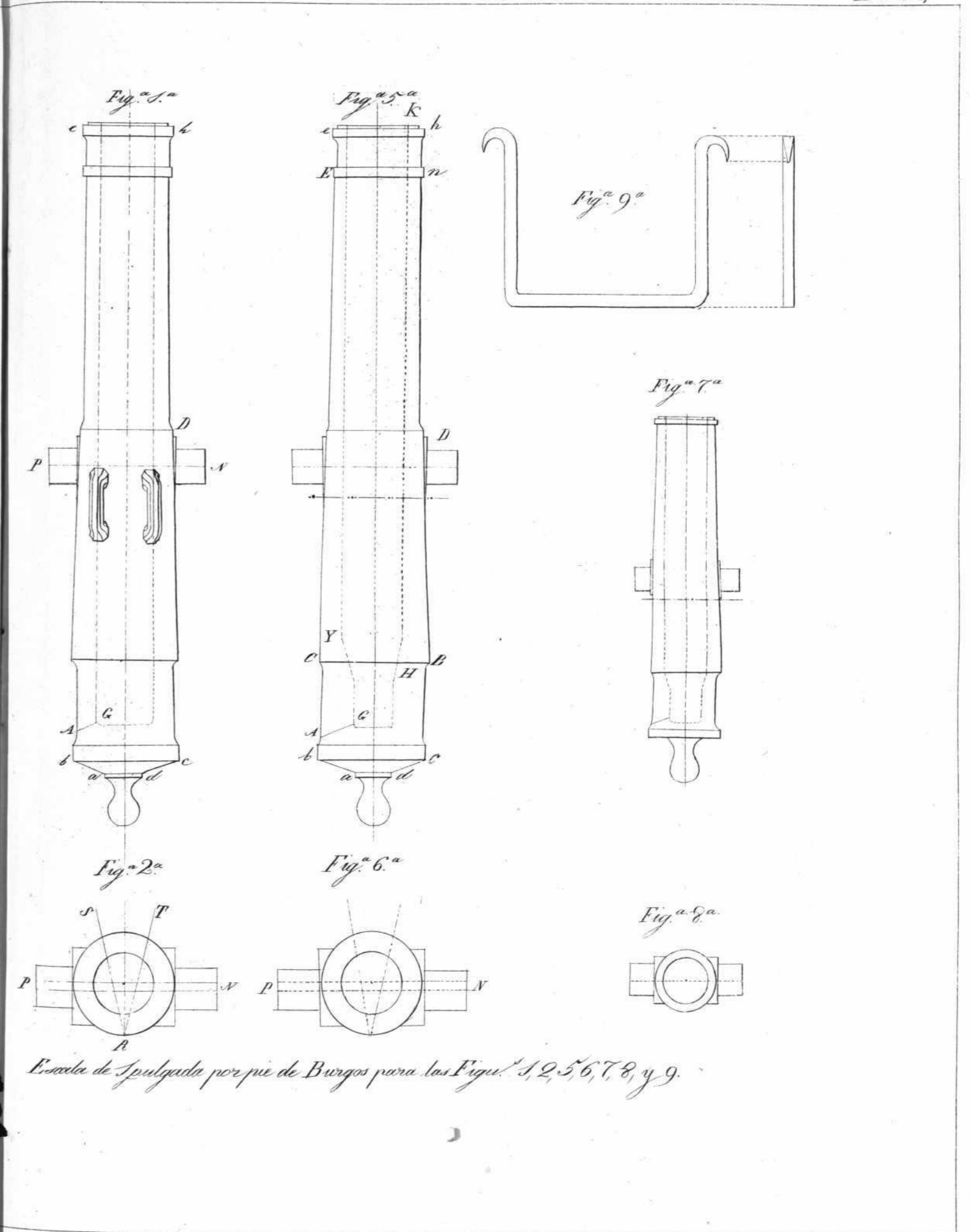
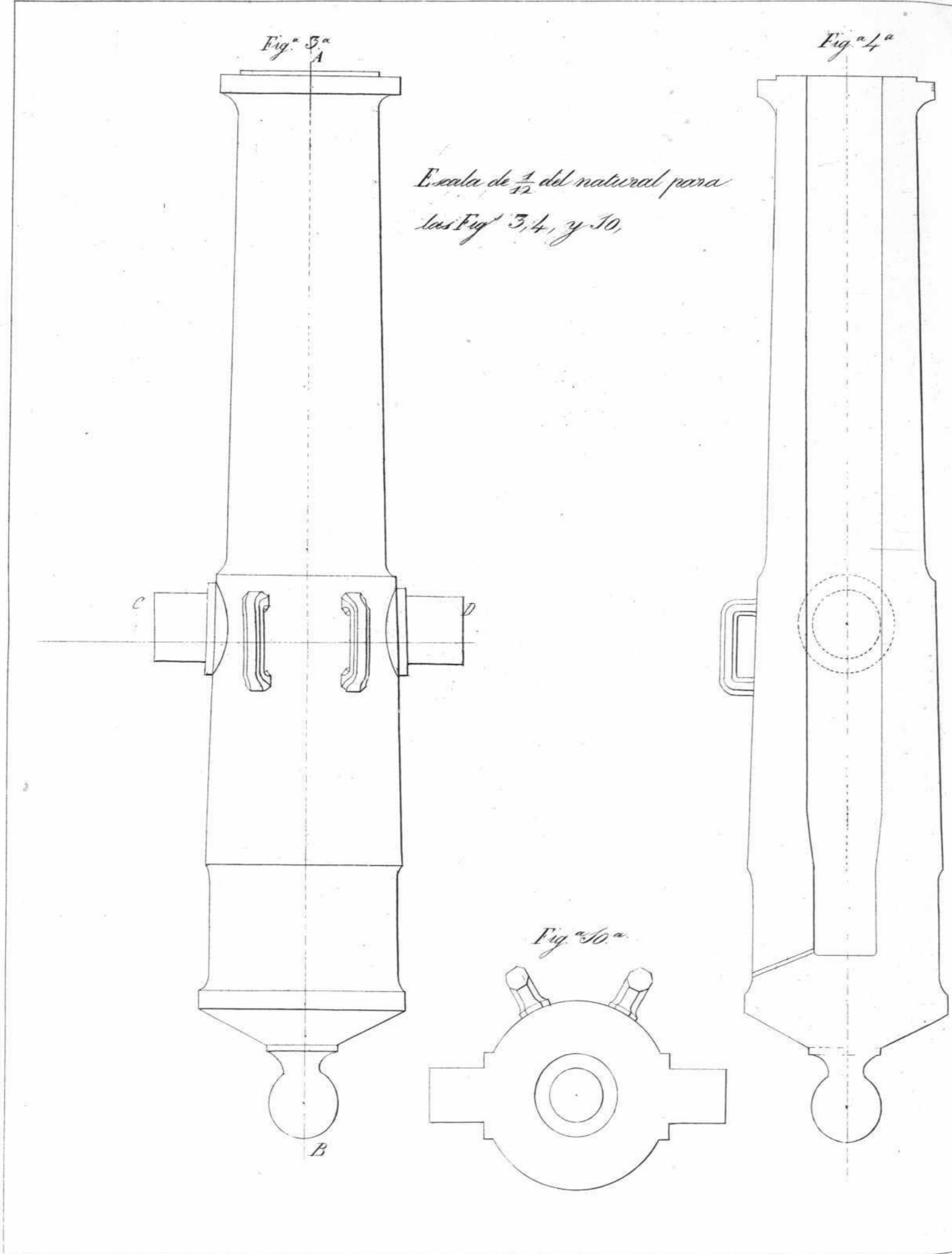




Fig.^a 1.^a

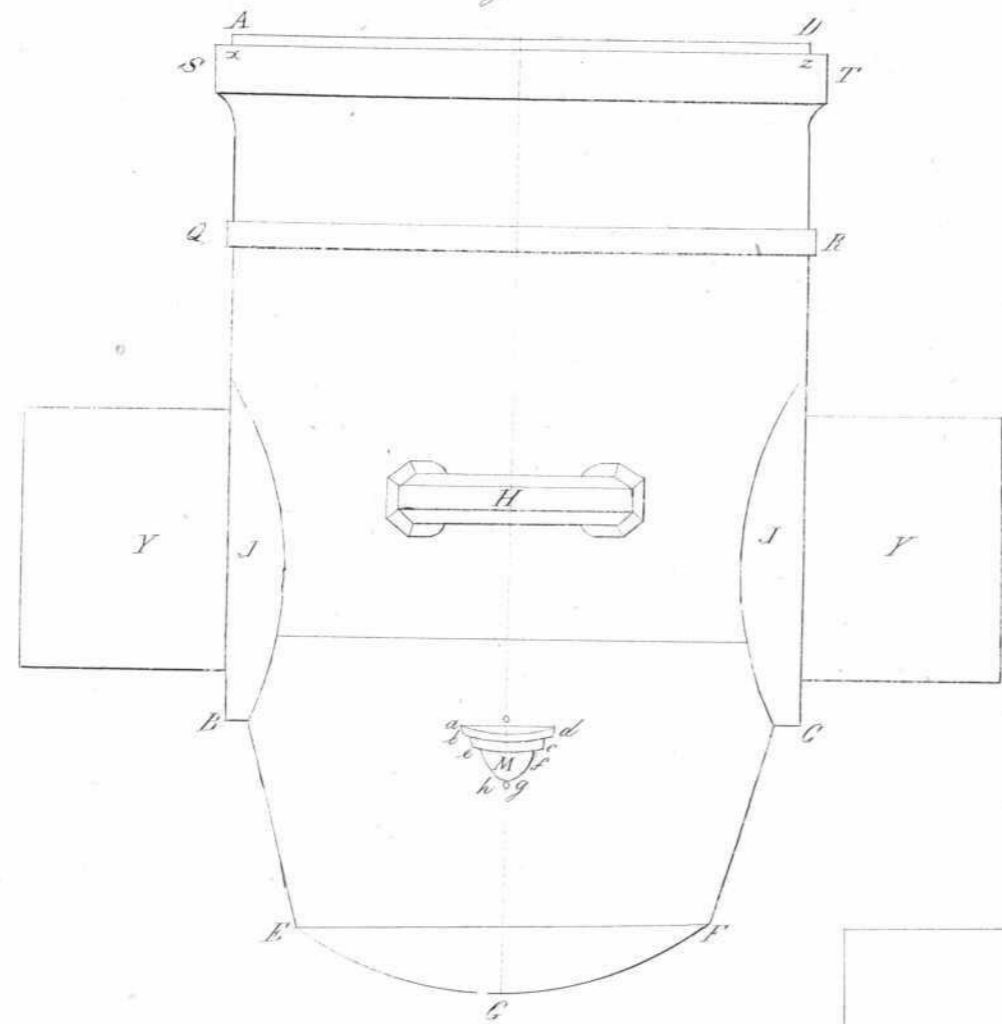


Fig.^a 2.^a

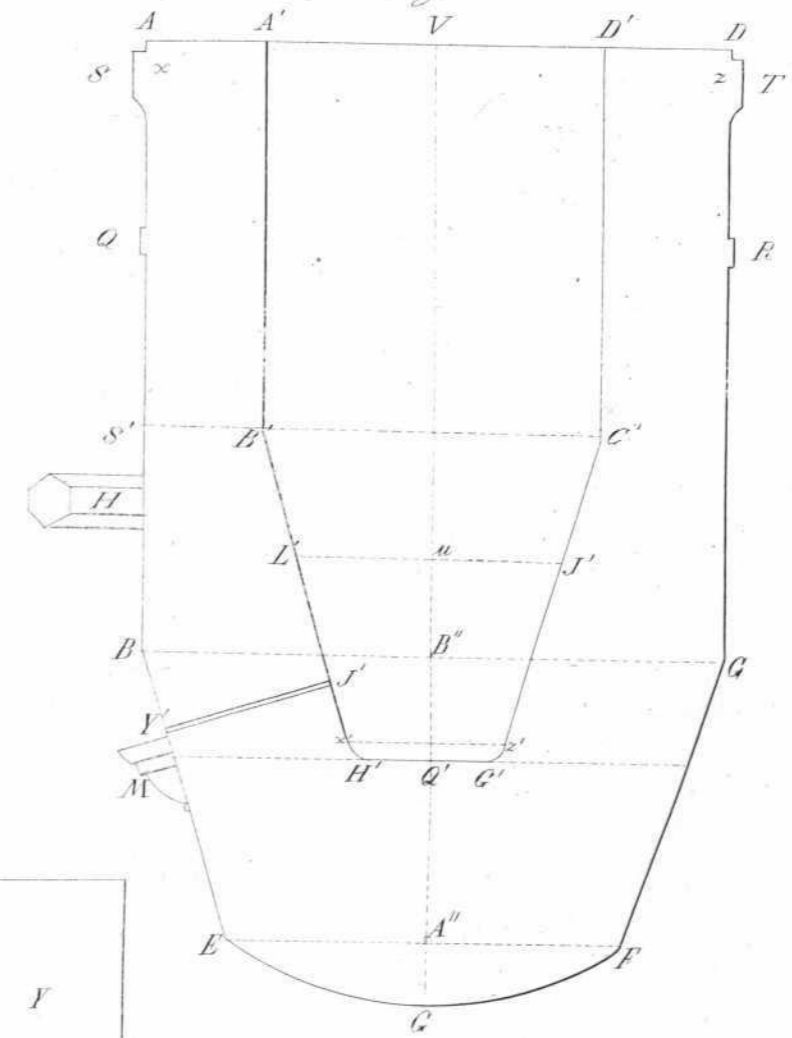
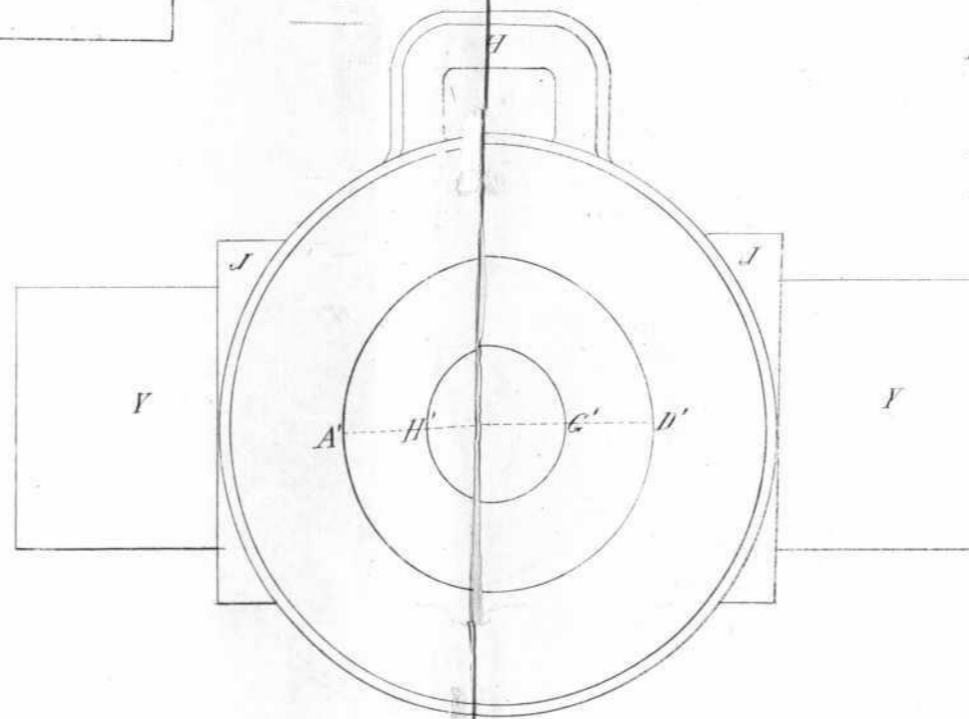
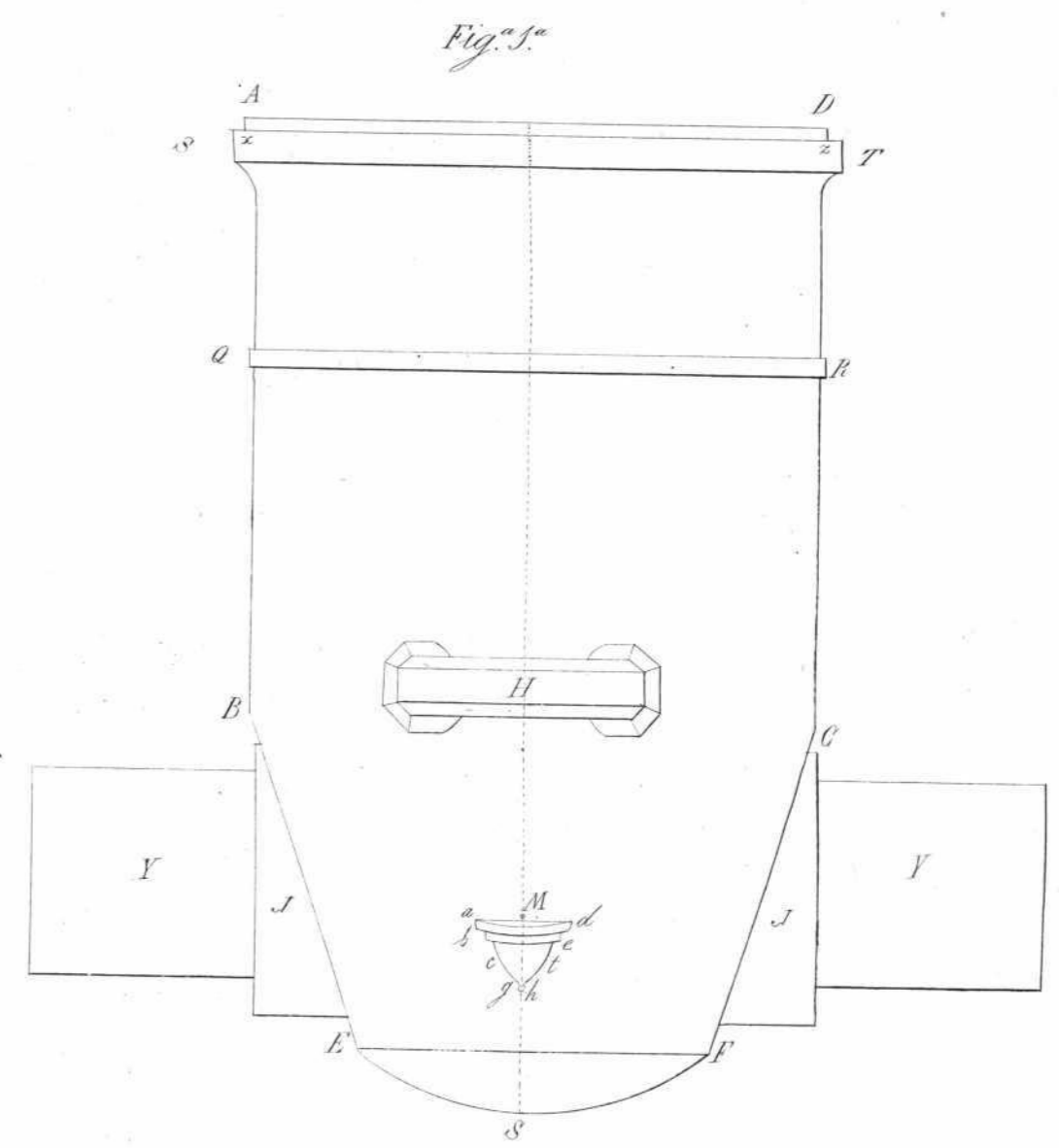
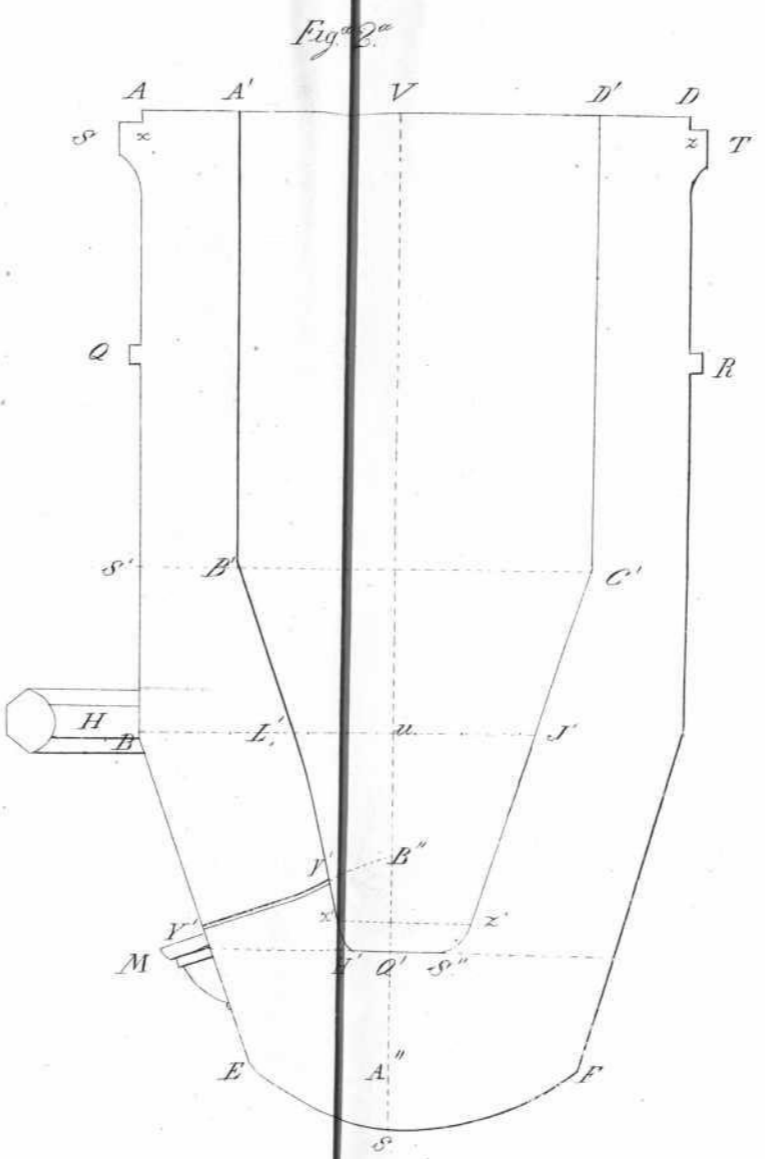
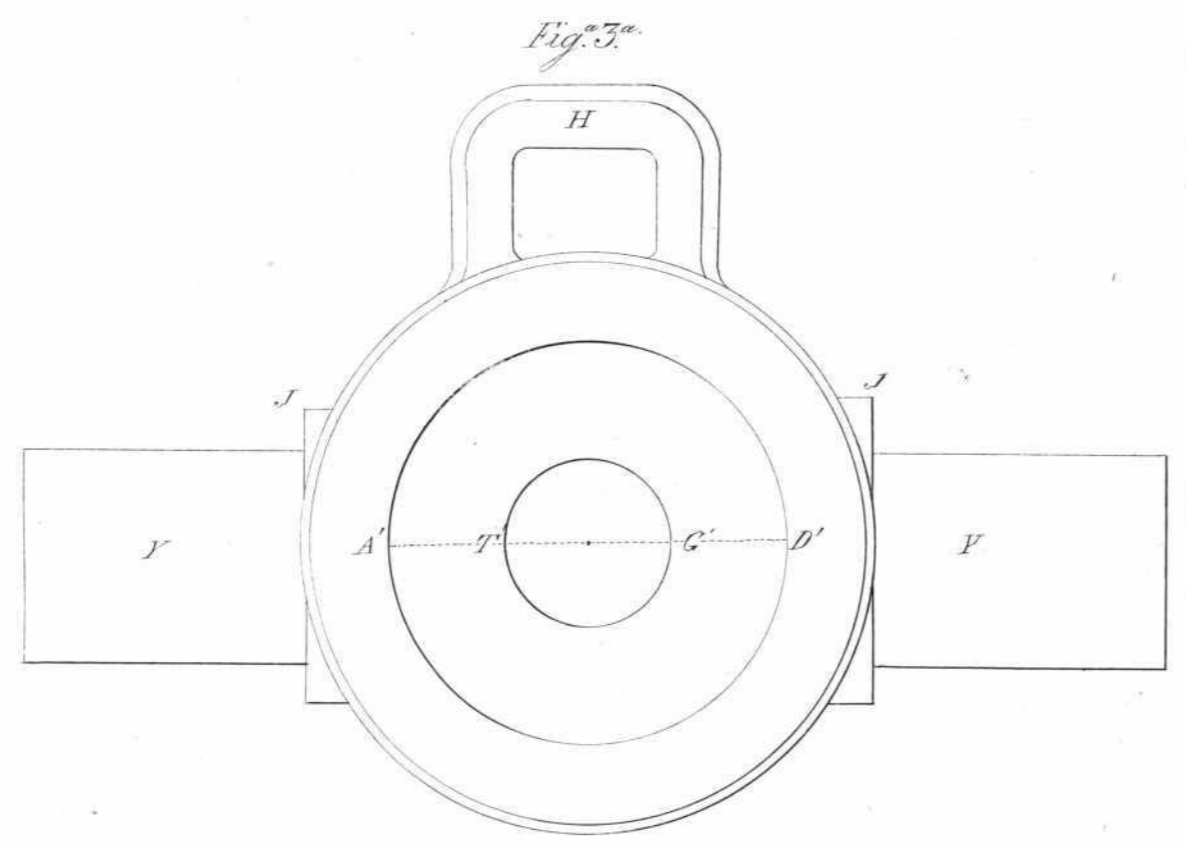


Fig.^a 3.^a



Escala de dos pulgadas por pie.
 Pulgadas de Castilla





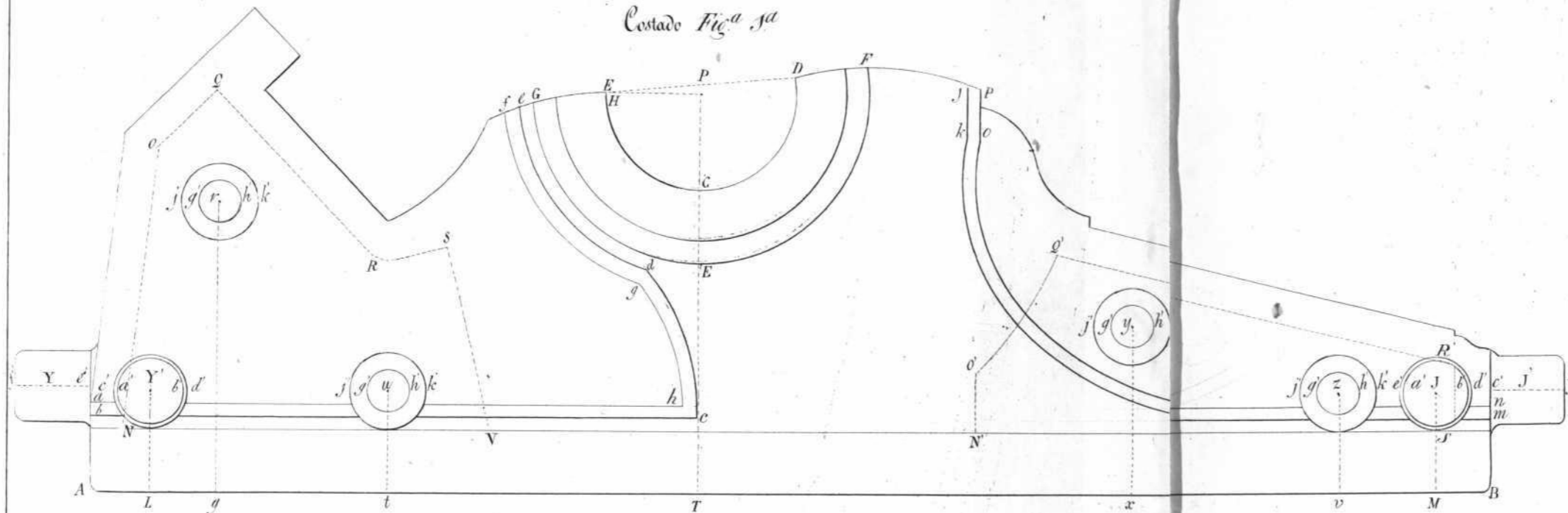
Escala de 1 pulgada por pie de Castilla.





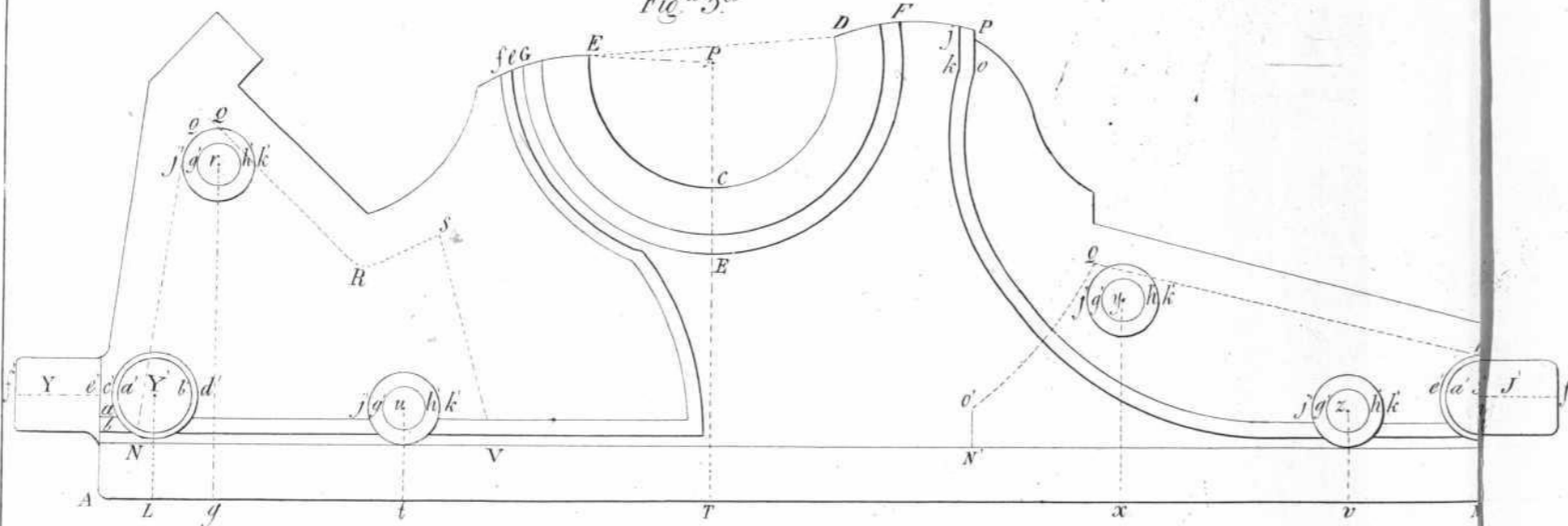
Guallera de bronce para afuste de mortero conico del calibre de n 24.

Costado Fig^a 3^a



Ydem para el calibre de a 32

Fig^a 5^a



Escala para las figuras 3, 2, 3, 4



Escala para las figuras 5, 6 y 9

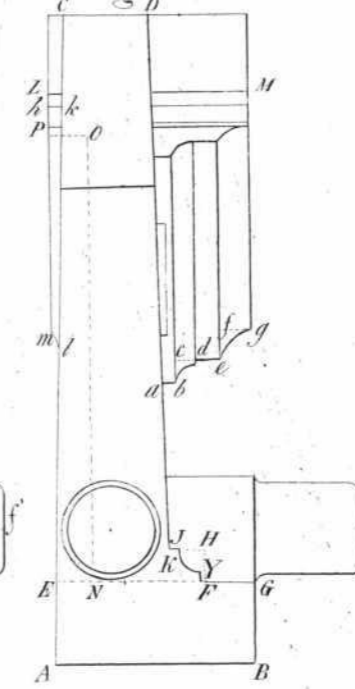


Escala para las figuras 7 y 8



Elevacion per la testera del de a 24

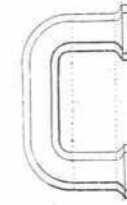
Fig^a 2^a



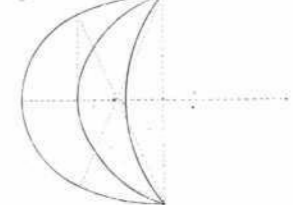
Fig^a 8^a



Fig^a 6^a

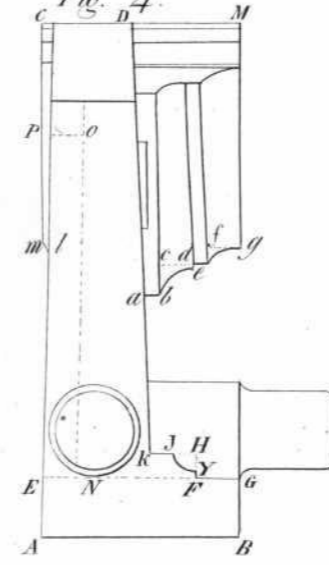


Fig^a 7^a

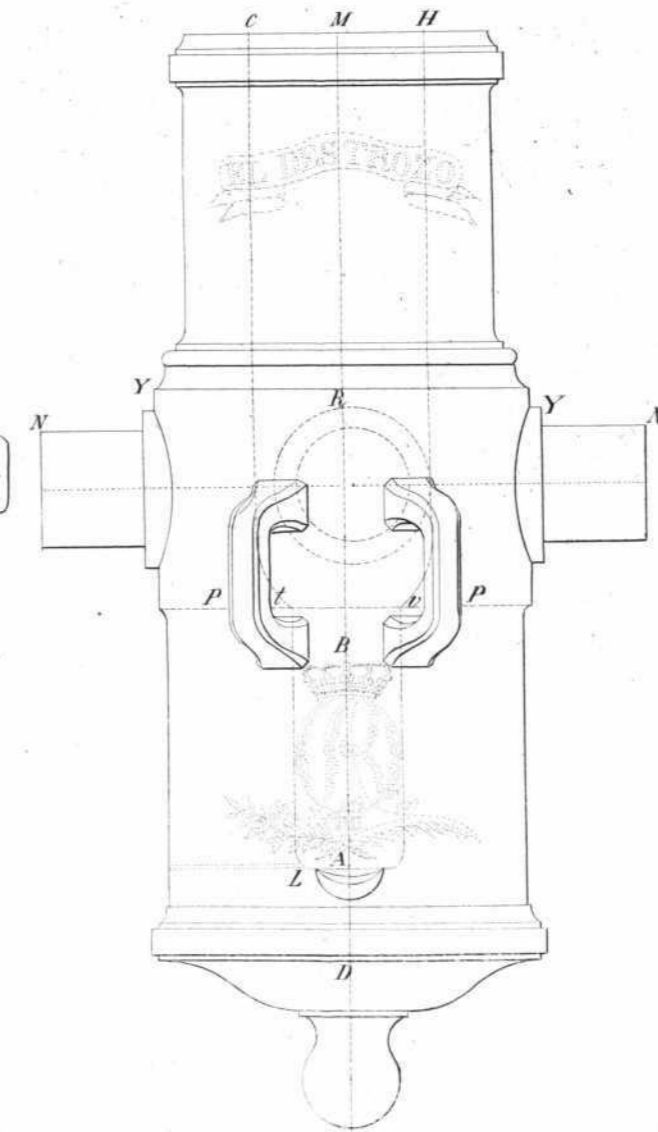


Ydem del de a 32

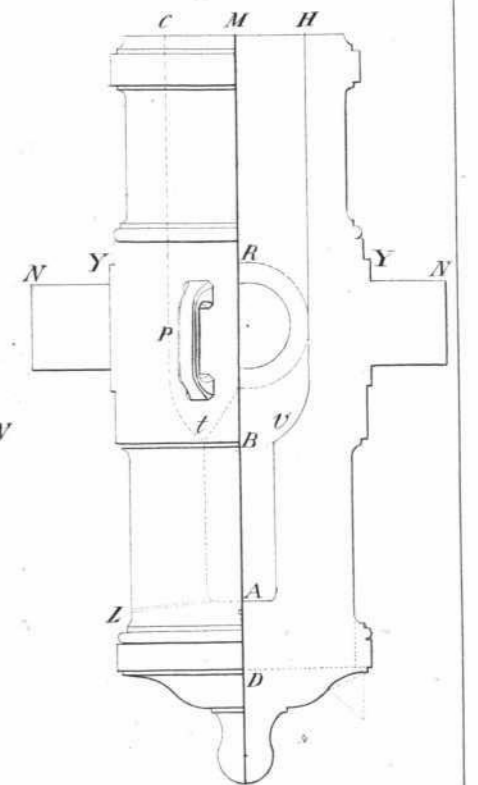
Fig^a 4^a



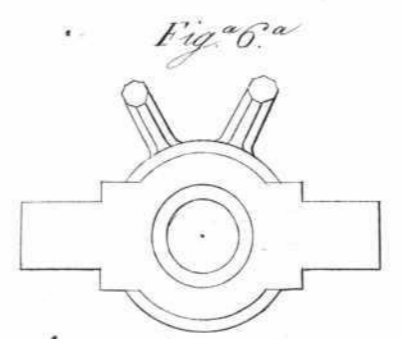
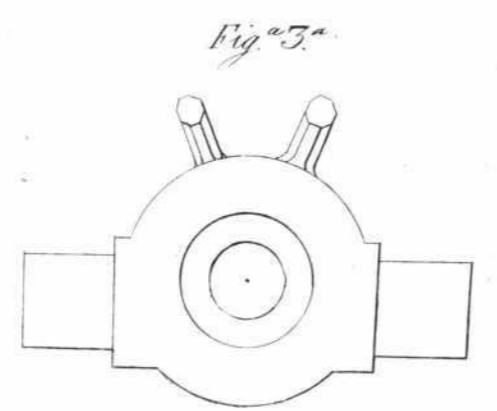
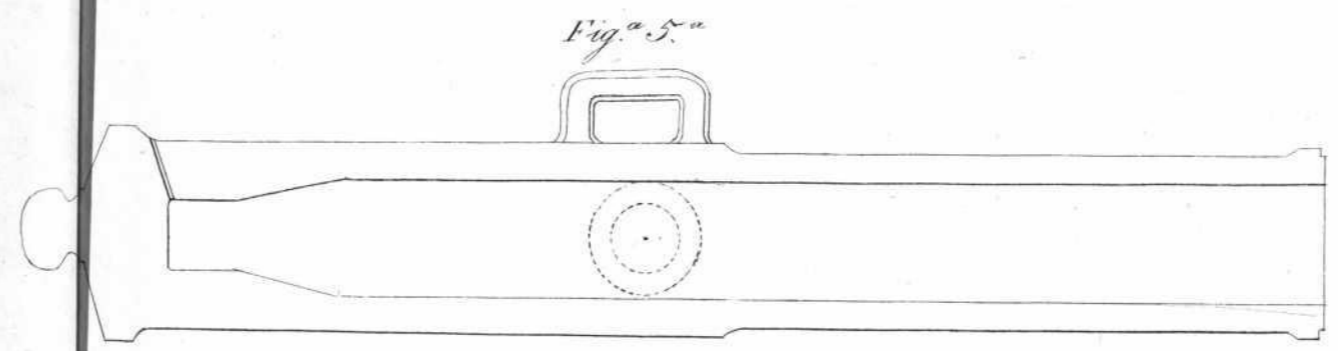
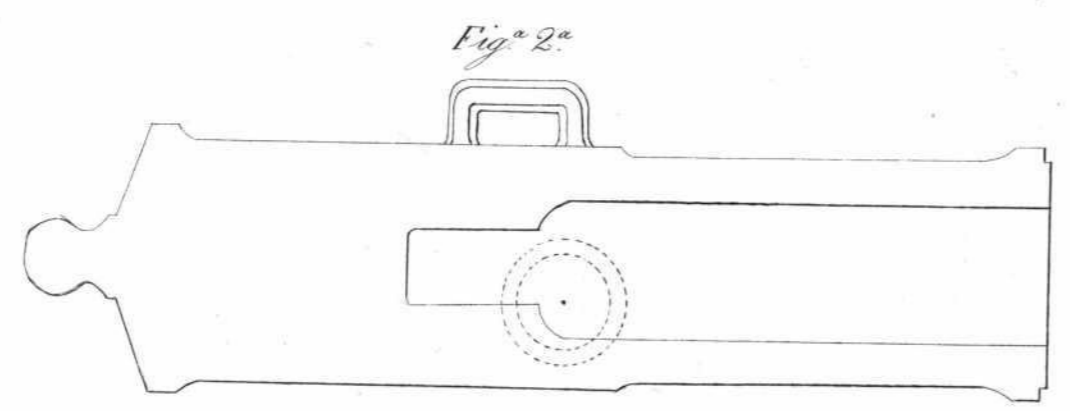
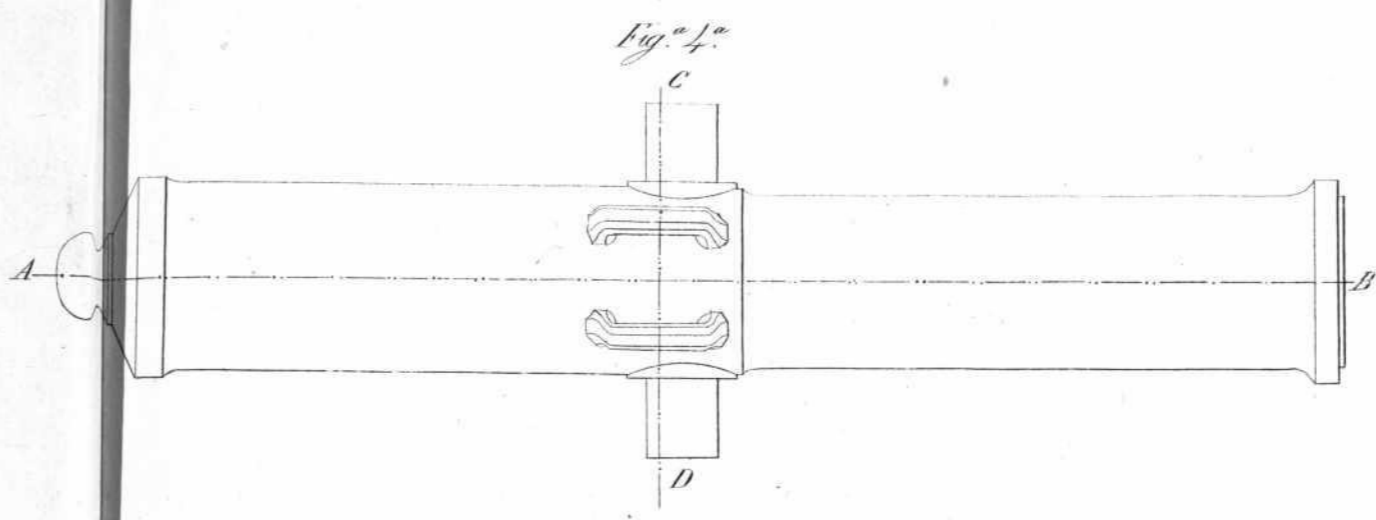
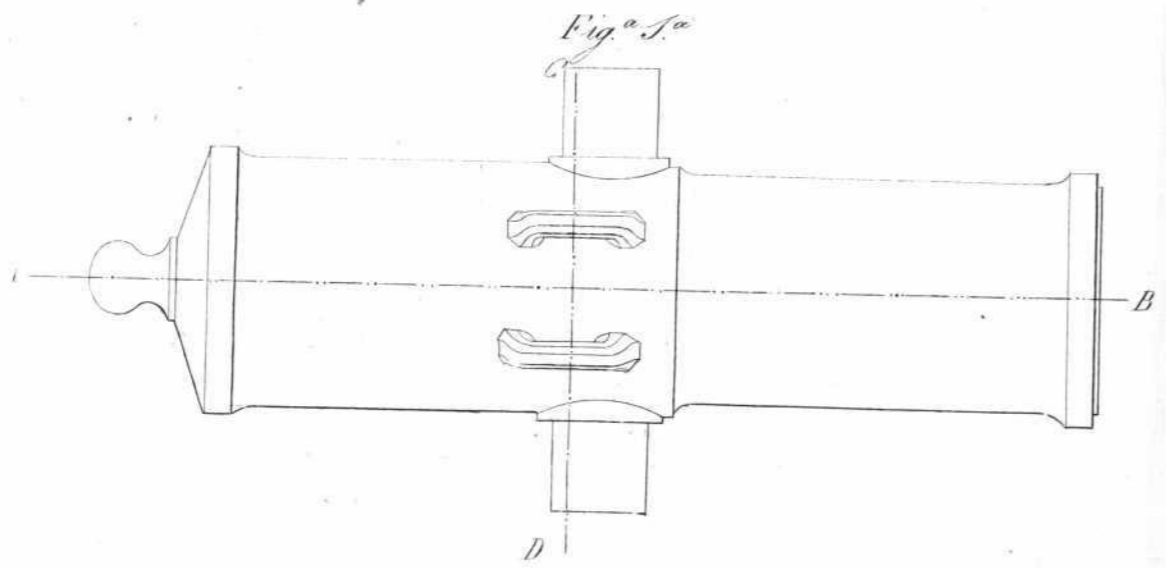
Fig^a 5^a



Fig^a 9^a







Escala $\frac{1}{12}$ del natural.



G 39299