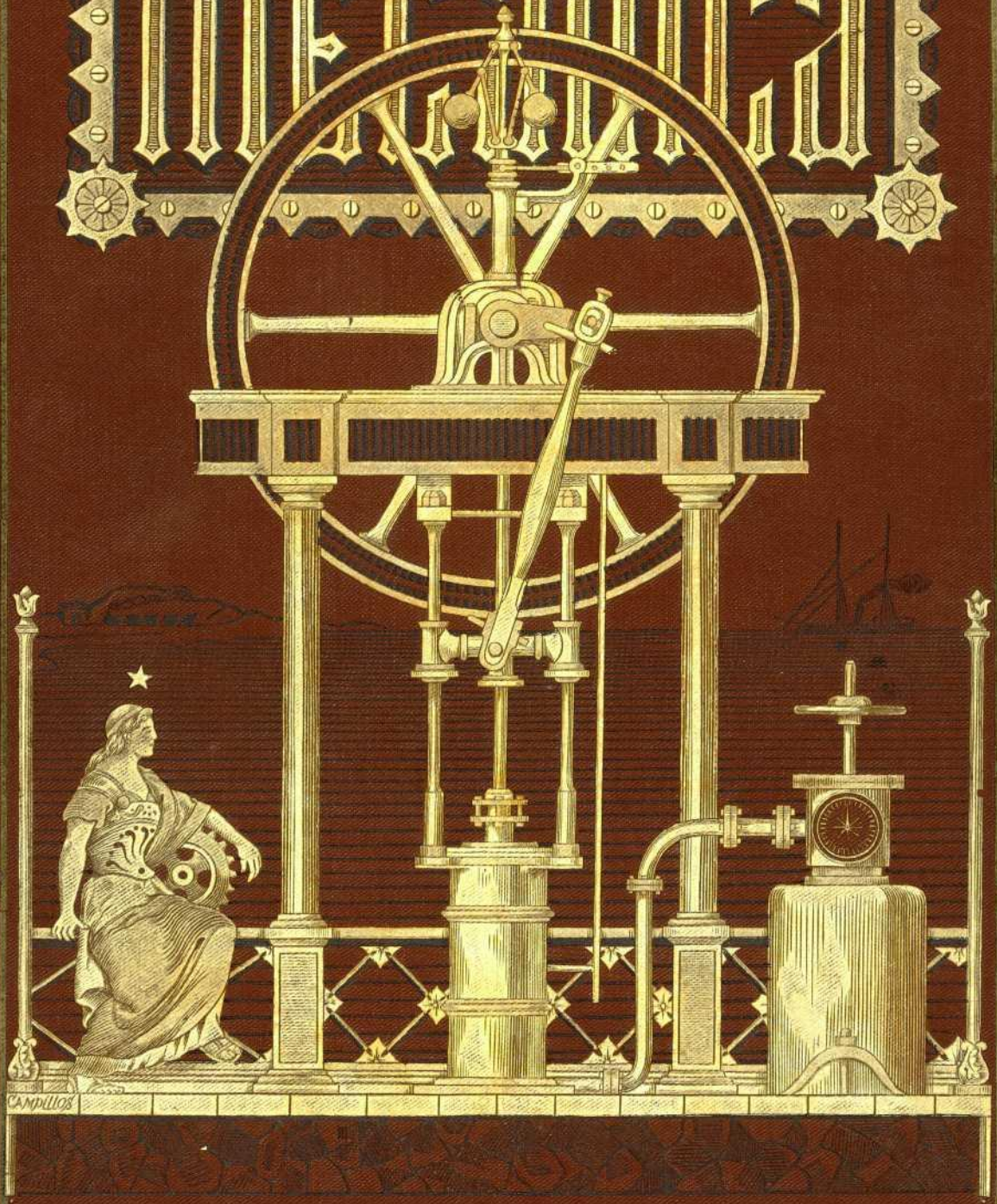


F. REULEAUX

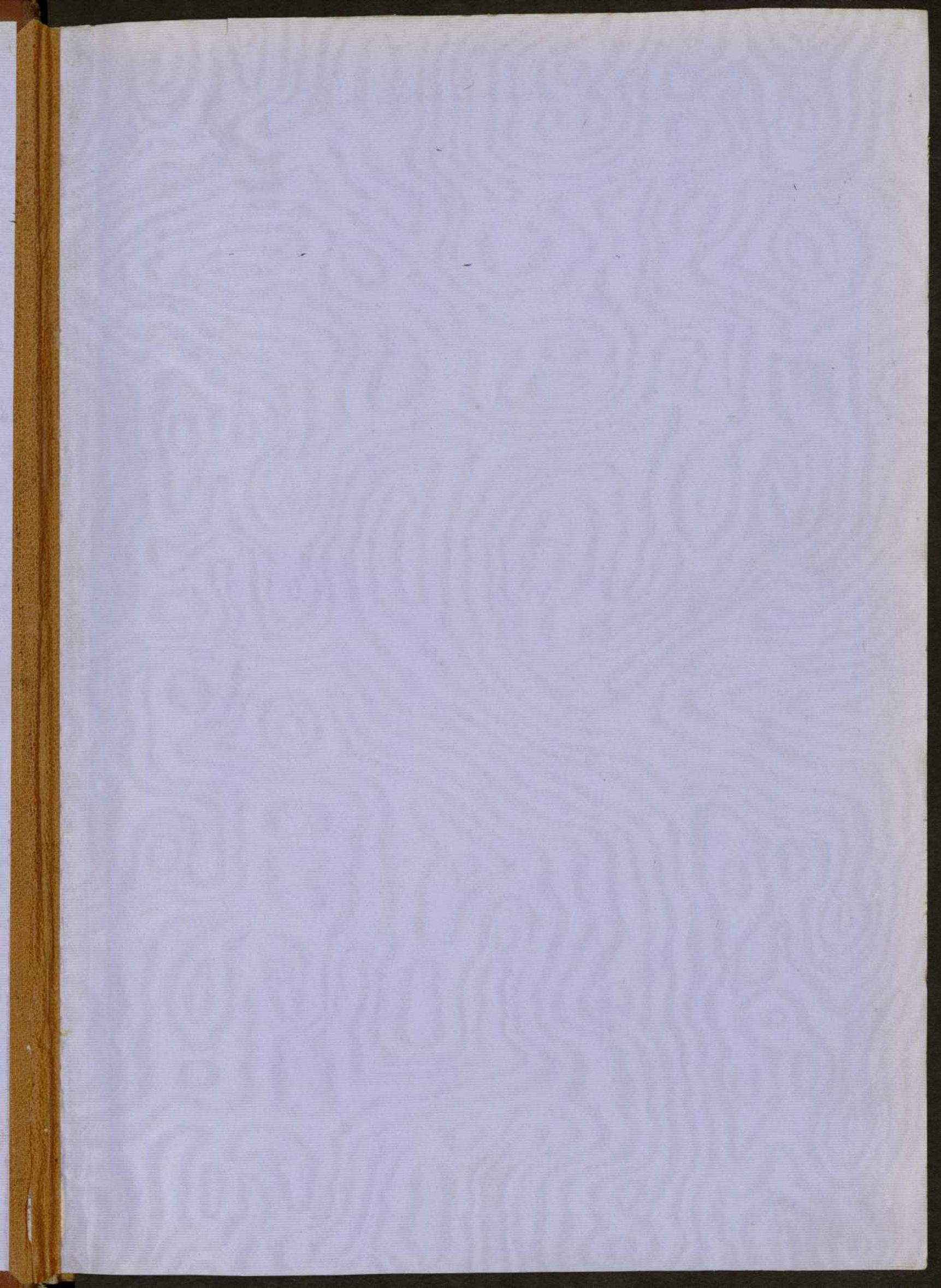
MACHINES



CANDILLON

IMPRESA LIBRERIA
Almacén de Papel
S. RODRIGUEZ
BURGOS

16458
~~2573~~



27
—
256

ATLAS
DE
APLICACIONES



1777
1777

1777

1777

TRATADO GENERAL
DE
MECÁNICA

PARA USO DE INGENIEROS, CONSTRUCTORES, MAQUINISTAS, ARQUITECTOS, &, &

COMPRENDE LAS OBRAS
CINEMÁTICA Y CONSTRUCTOR
DE
V. F. REULEAUX

CATEDRÁTICO DE LA ESCUELA POLITÉCNICA Y DIRECTOR
DE LA ACADEMIA INDUSTRIAL DE BERLIN, COMISIONADO IMPERIAL EN LAS EXPOSICIONES INTERNACIONALES DE
SYDNEY, MELBURNA, FILADELFIA, &, &

TRADUCCION DE LAS ÚLTIMAS EDICIONES ALEMANAS
AUMENTADA CON LA

MECÁNICA PRACTICA Y APLICADA

MÁS MODERNA Y UNIVERSALMENTE CONOCIDA EN LAS NACIONES INDUSTRIALES

PUBLICADA BAJO LA DIRECCION DE

D. FRANCISCO NACENTE Y SOLER

AUTOR DE VARIAS OBRAS CIENTÍFICAS, EX-PRESIDENTE DEL «CENTRO INDUSTRIAL DE CATALUÑA», PRESIDENTE
HONORARIO DEL «FOMENTO INDUSTRIAL» DE BARCELONA

Ilustrada con unas 7.000 á 8.000 figuras de maquinaria comprendidas
en unas 800 láminas grabadas
primorosamente en la piedra é impresas con sumo esmero



ATLAS



BARCELONA

F. NACENTE, EDITOR: PASEO DE GRACIA, 149

1887

Esta obra es propiedad del Editor, quien se reserva todos los derechos de propiedad literaria y artística de la misma, y perseguirá al amparo de las leyes á todo aquel que la reimprima ó que reproduzca sus láminas fraudulentamente.

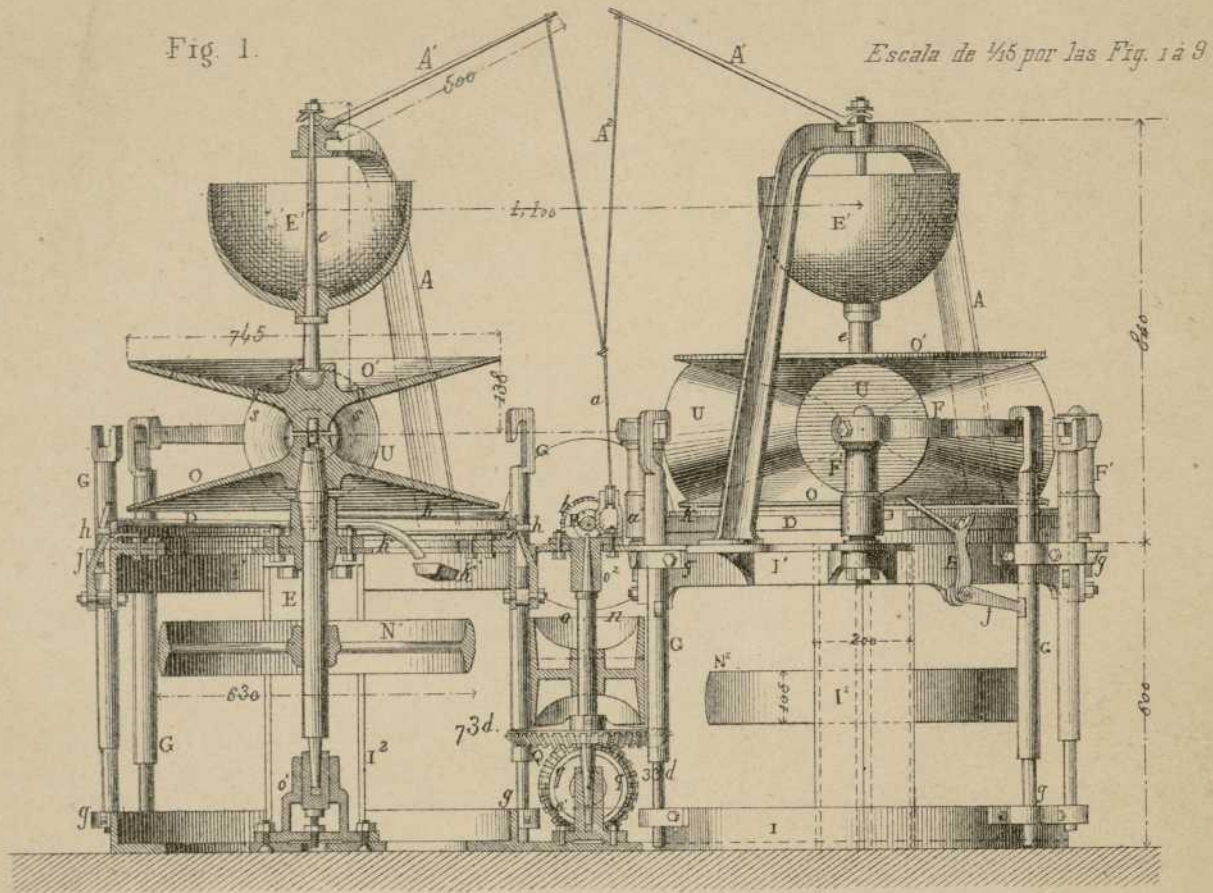


Fig. 7.

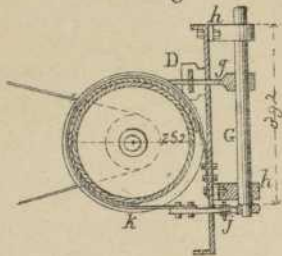


Fig. 6.

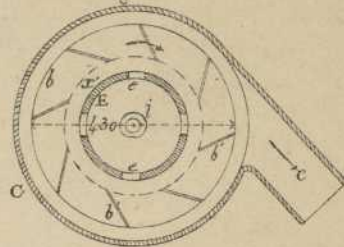


Fig. 4.

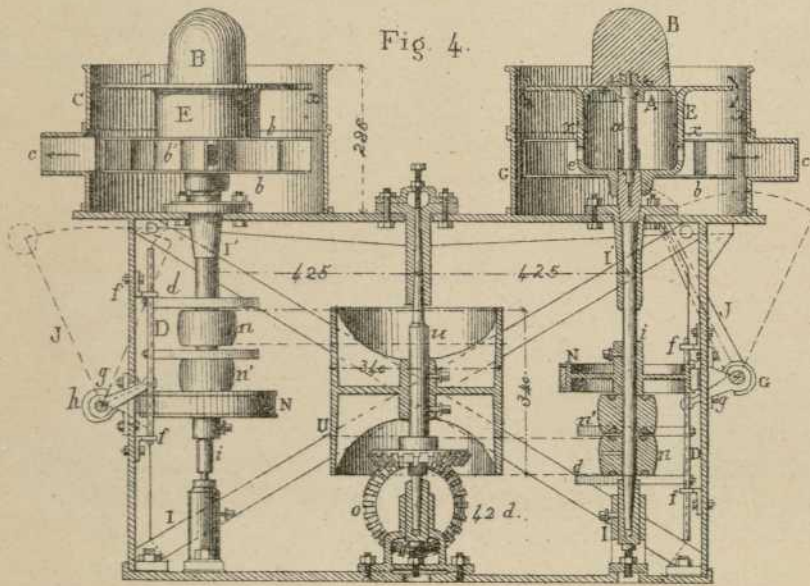
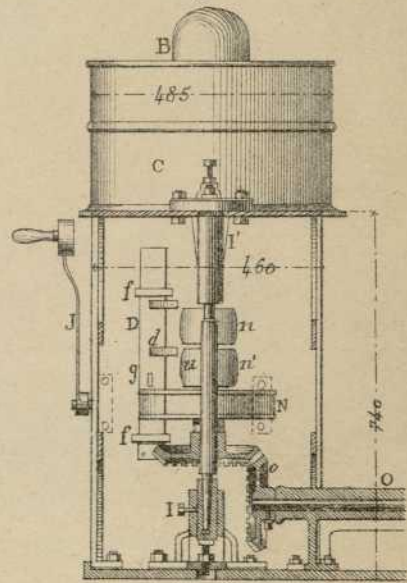
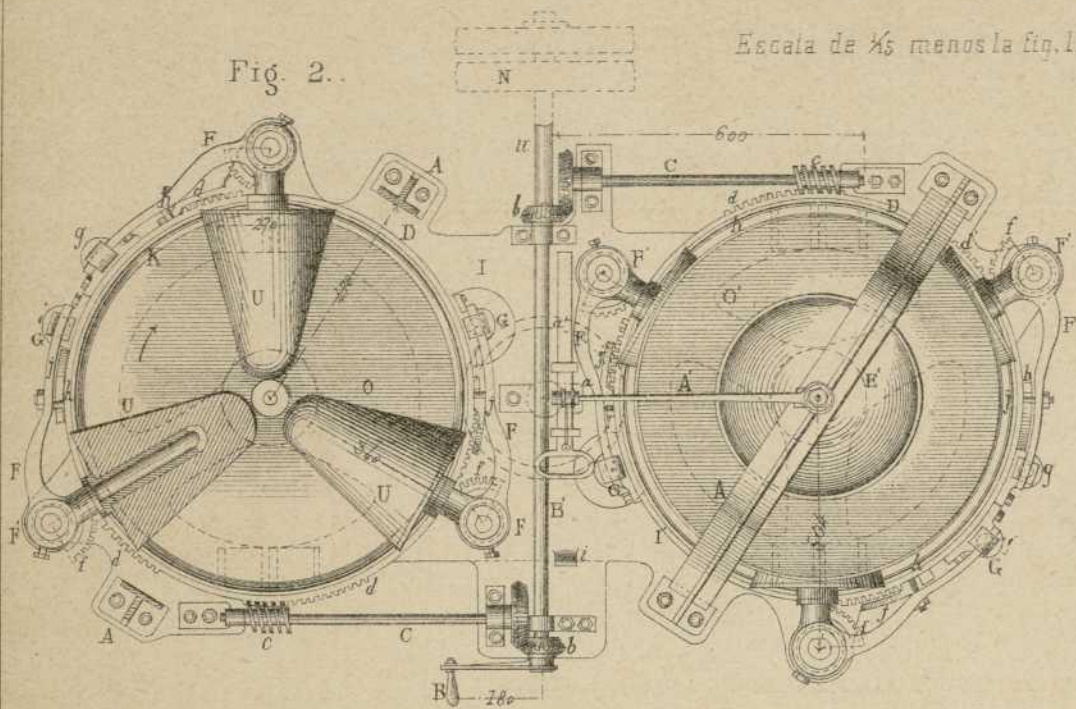


Fig. 5.



H. C.

Fig. 2.



Escala de $\frac{1}{5}$ menos la fig. 10

Fig. 3.

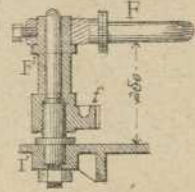
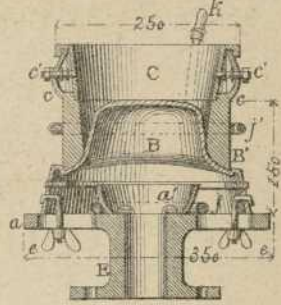


Fig. 10.



Escala de $\frac{1}{10}$

Fig. 9.

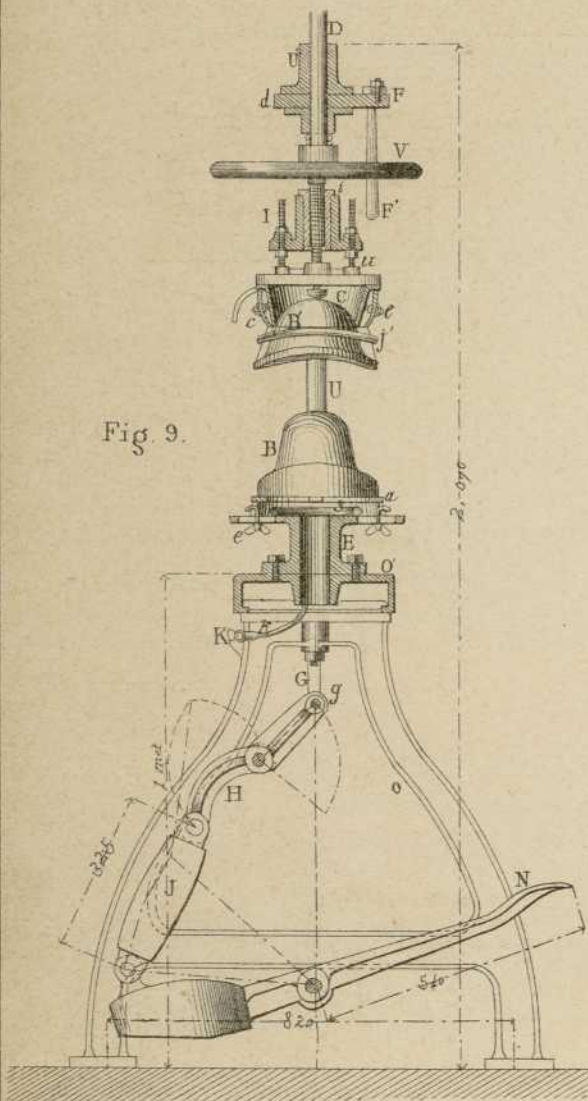
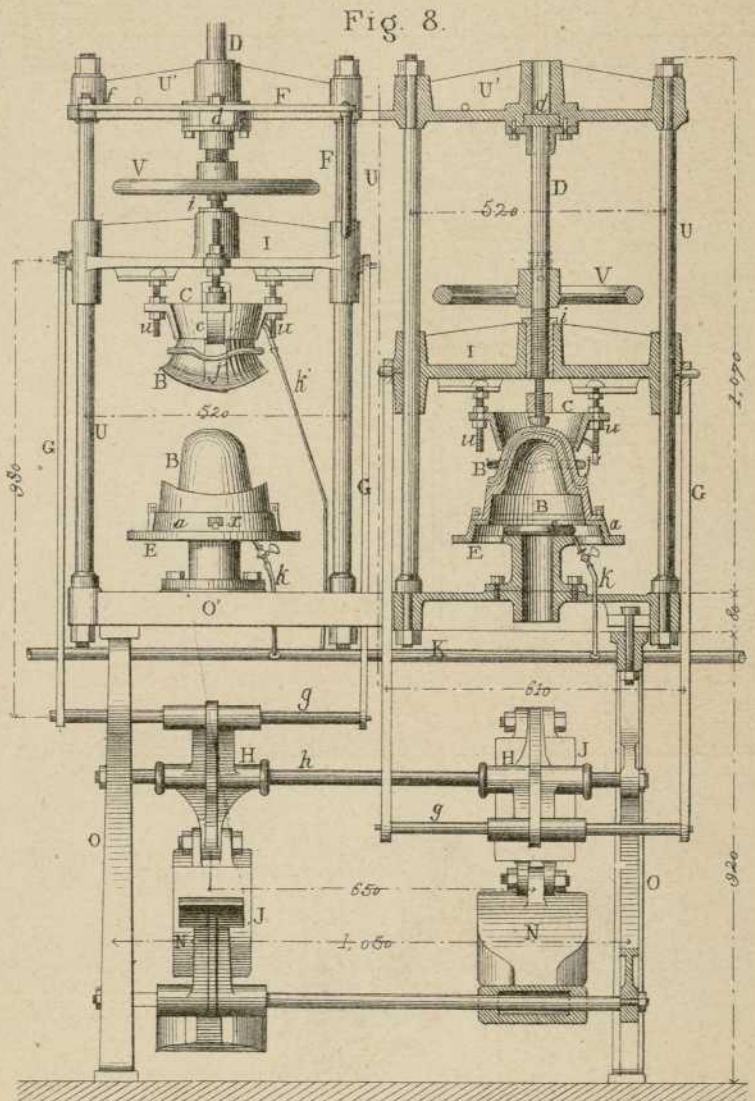
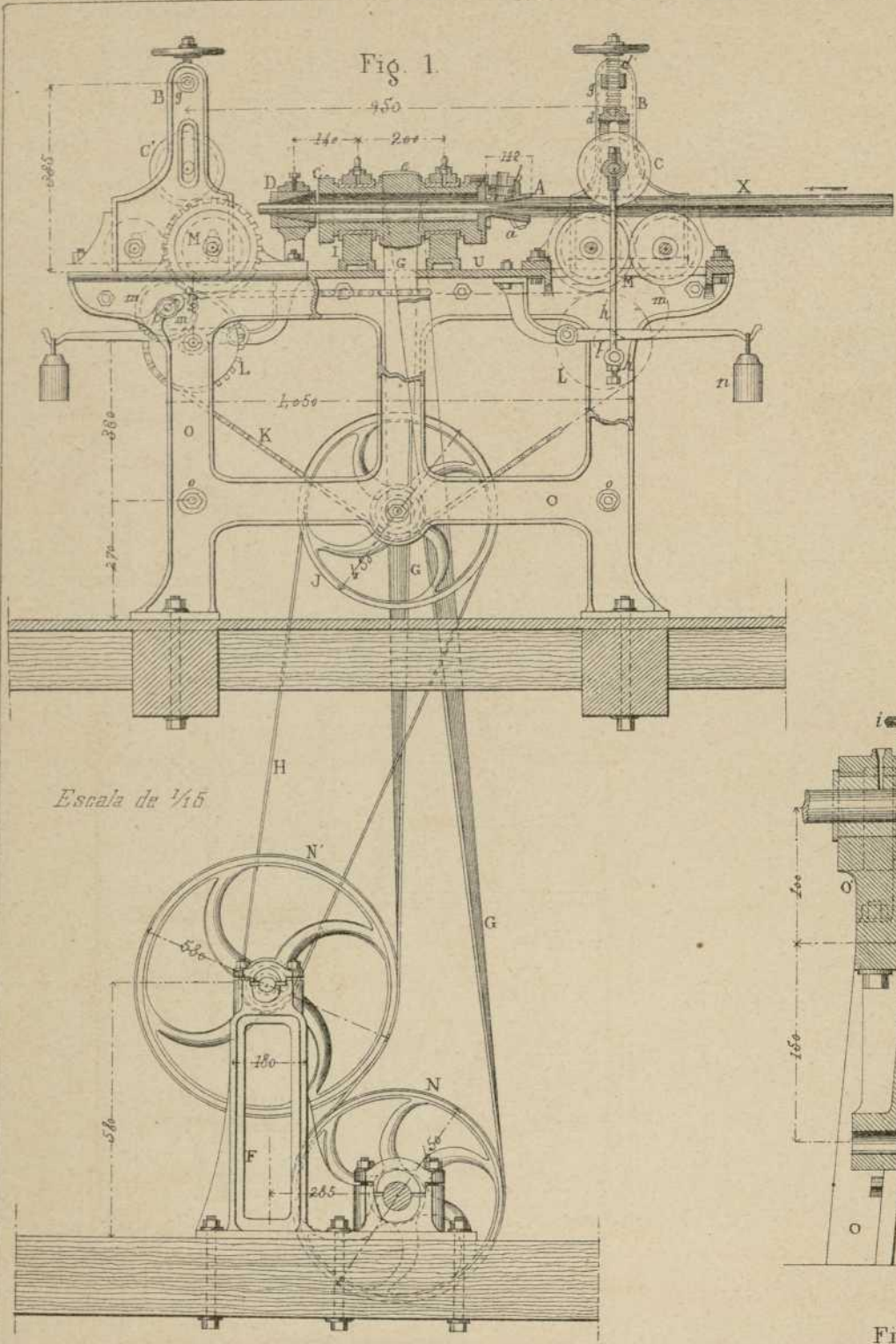


Fig. 8.





Escala de 1/15

Fig. 6.

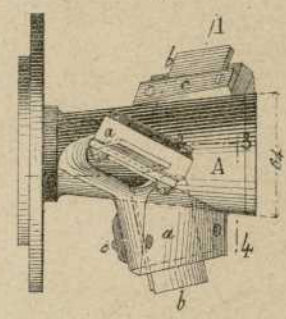
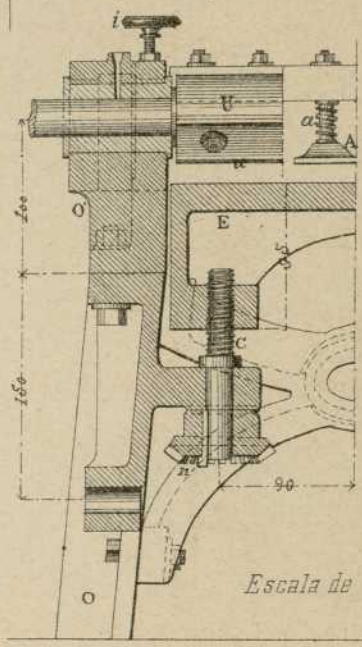
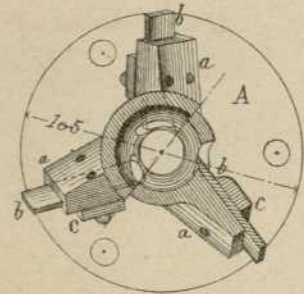


Fig. 10.



Escala de 1/6.

Fig. 4.



Escala de 1/4

Fig. 5.

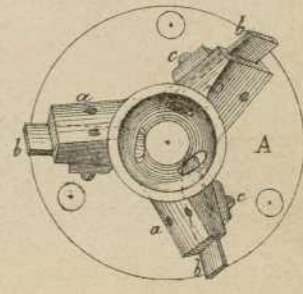


Fig. 2.

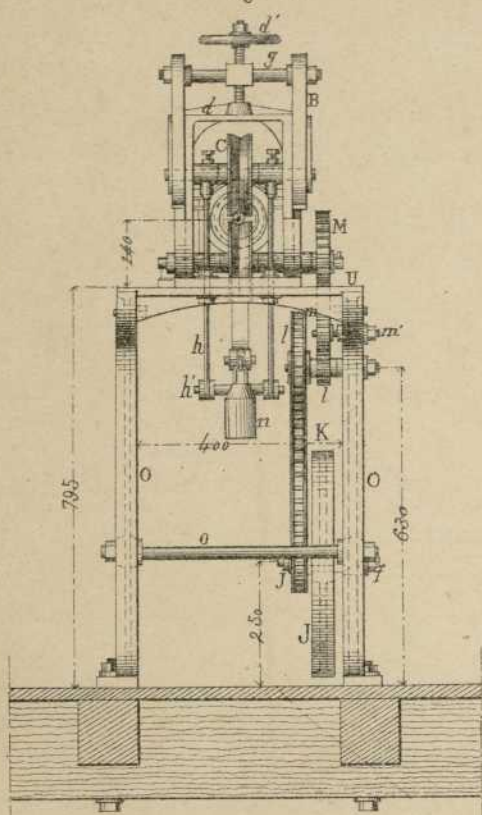


Fig. 8.

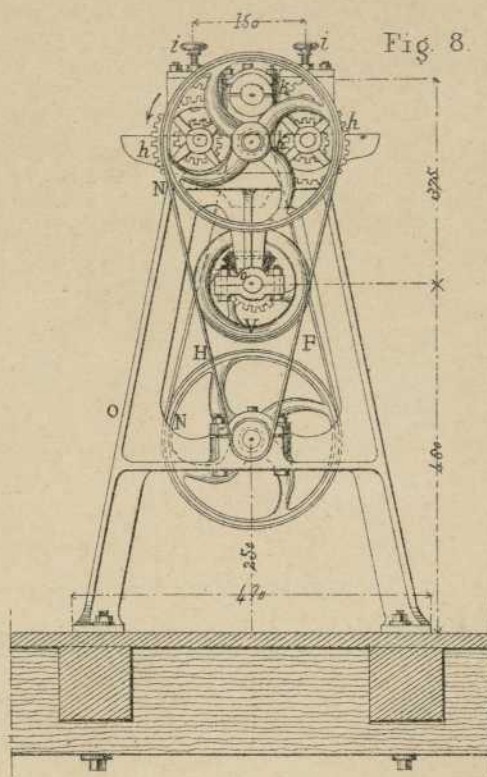
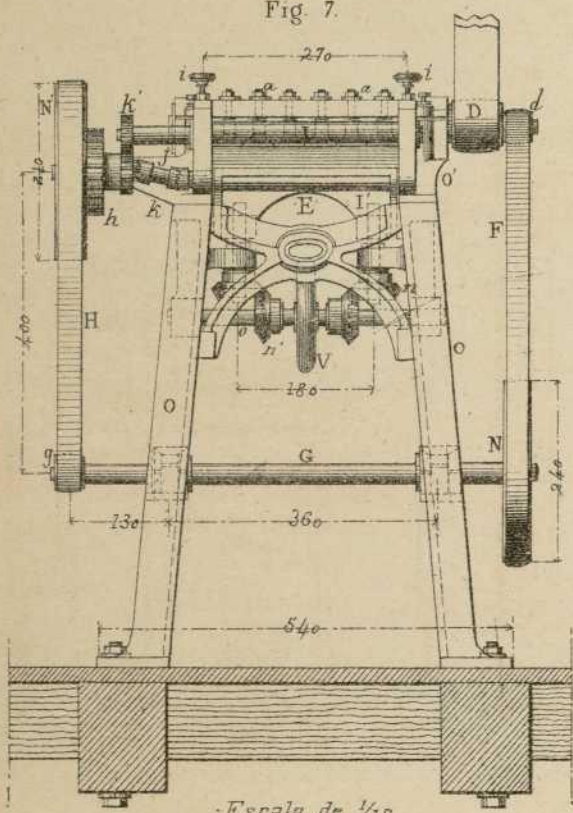
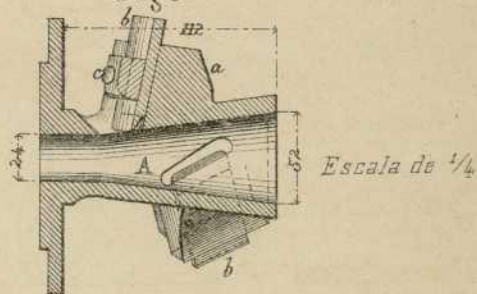


Fig. 7.



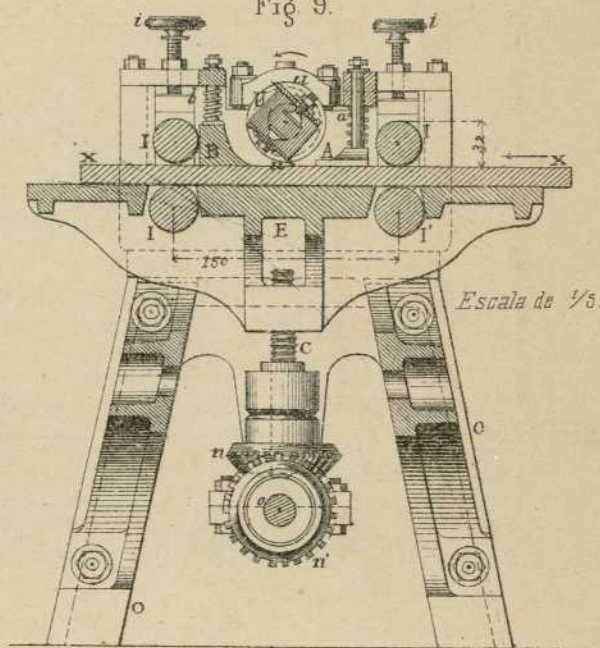
Escala de 1/10

Fig. 3.



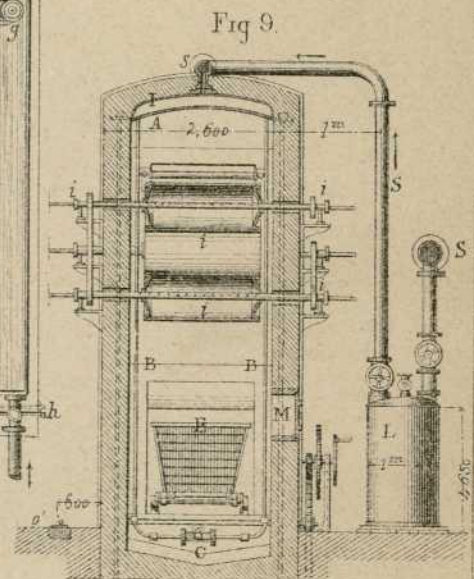
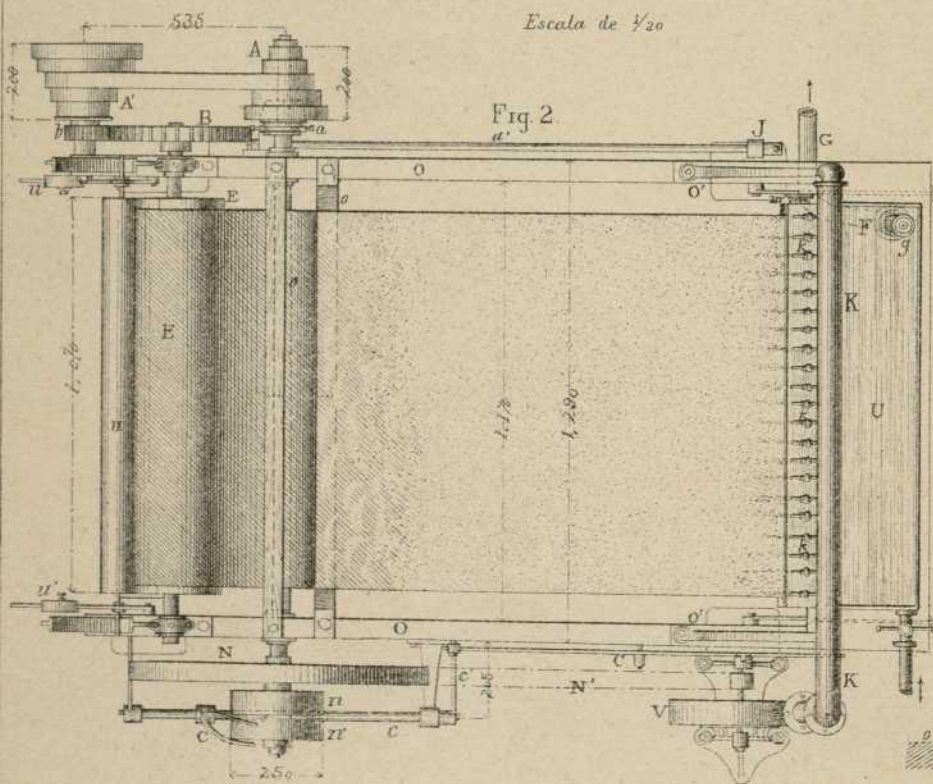
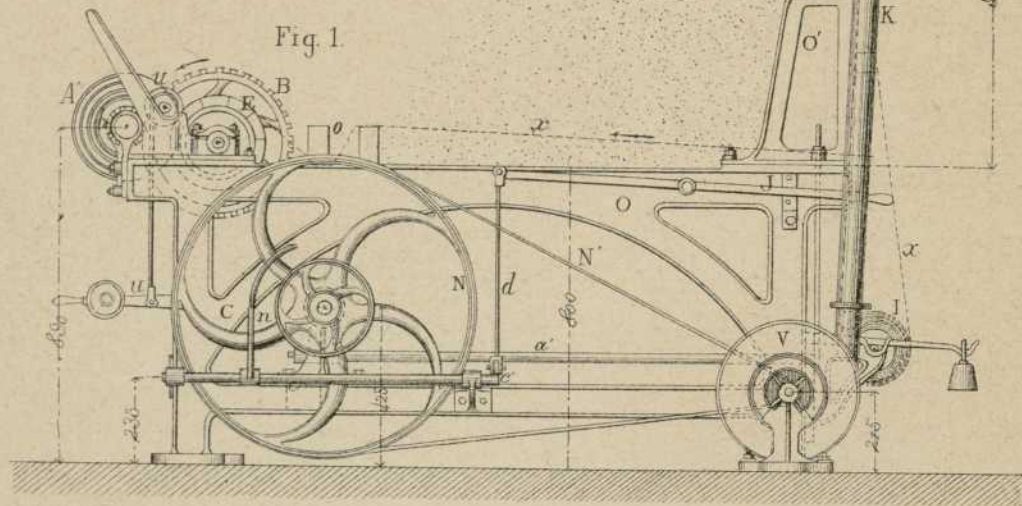
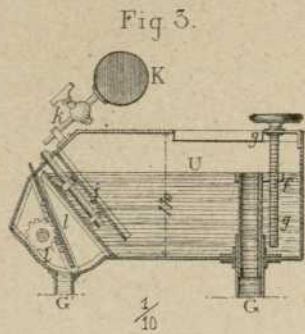
Escala de 1/4

Fig. 9.



Escala de 1/5.

H.E.

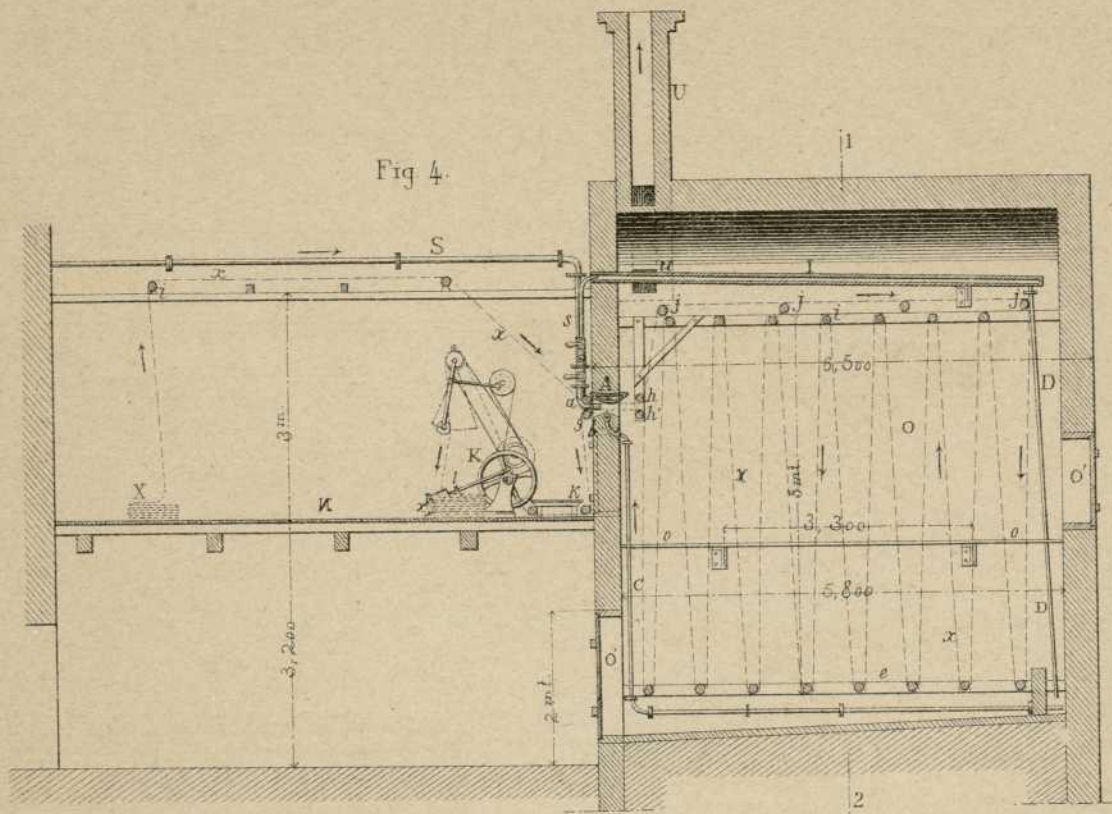


H.C.

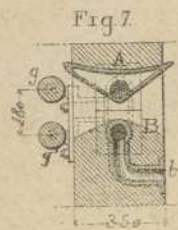
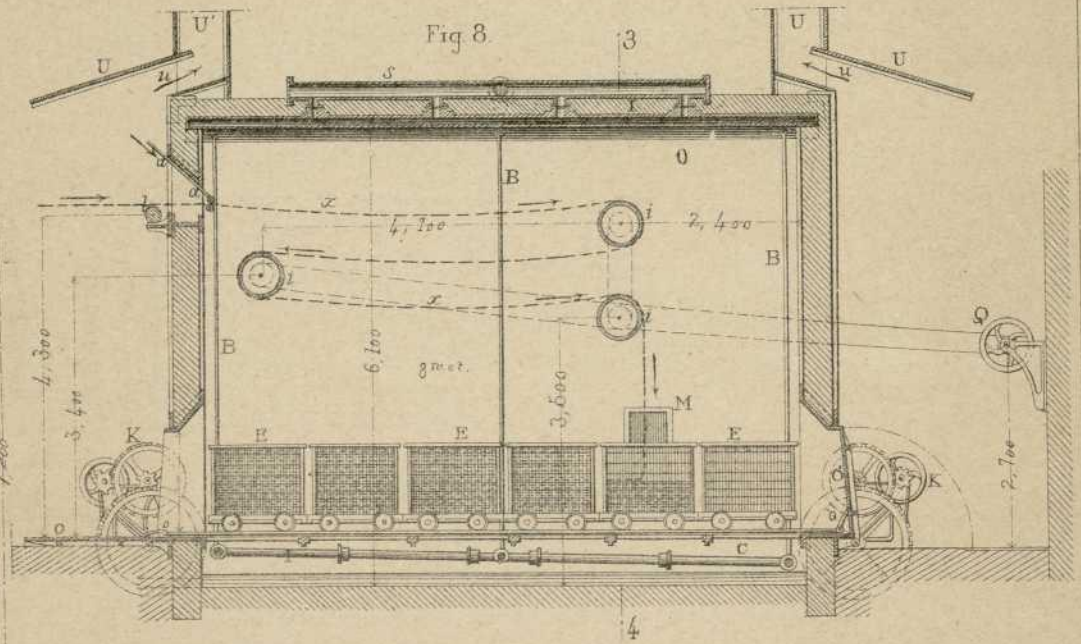
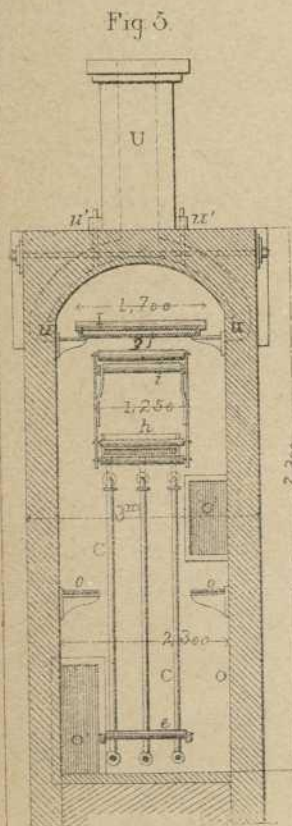
Nacenta, editor.

Escala de 1/100

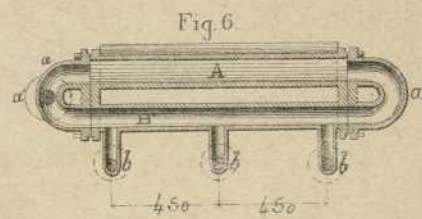
Paseo de Gracia, 146.



Escala de 1/100



1/30



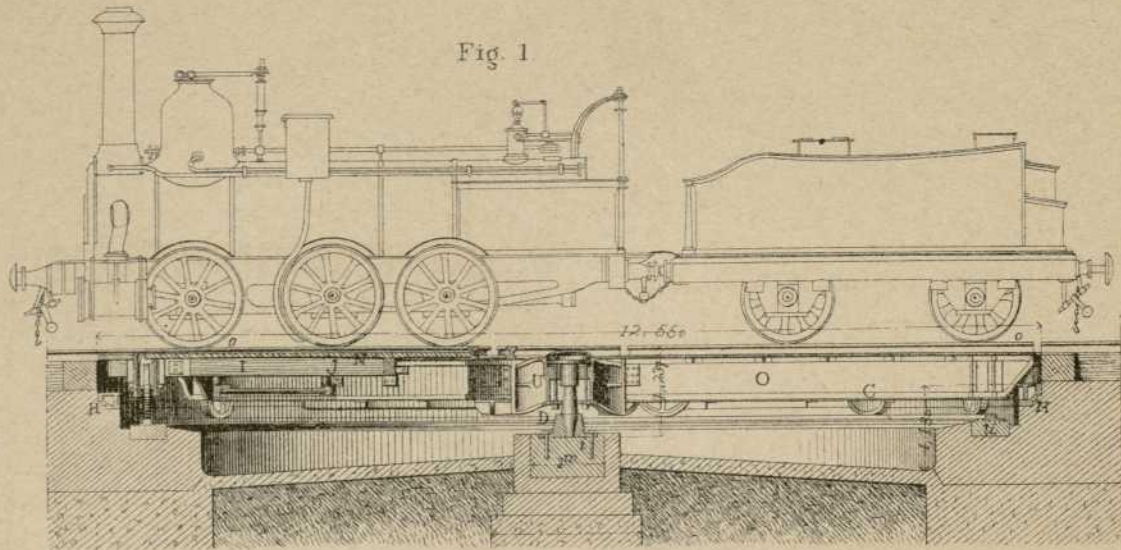


Fig. 1

Escala de 1/100 por las Fig. 1 y 2.

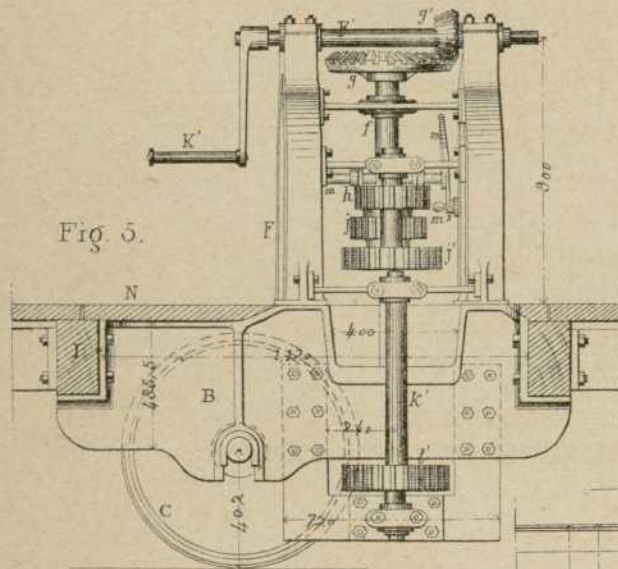


Fig. 5.

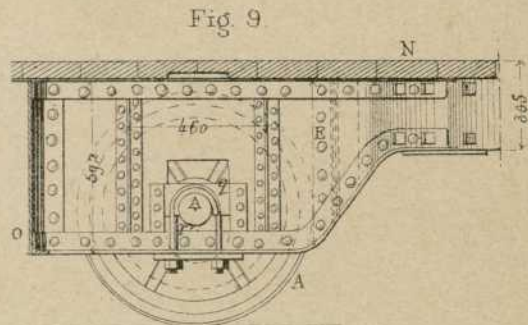


Fig. 9

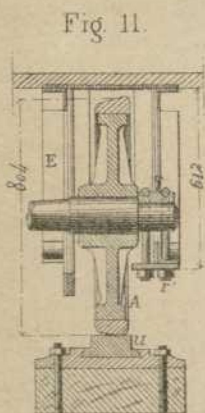


Fig. 11.

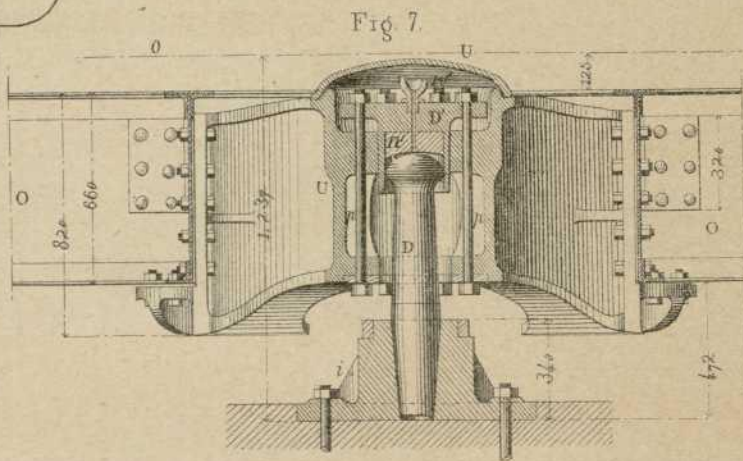


Fig. 7.

Escala de 1/25 por las Fig. 3 a 13.

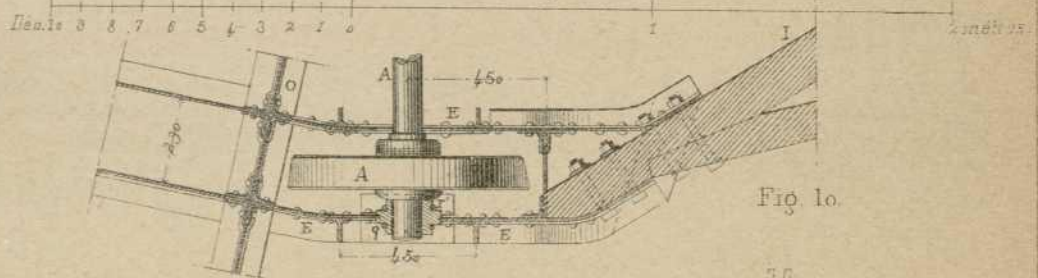


Fig. 10.

Fig. 2.

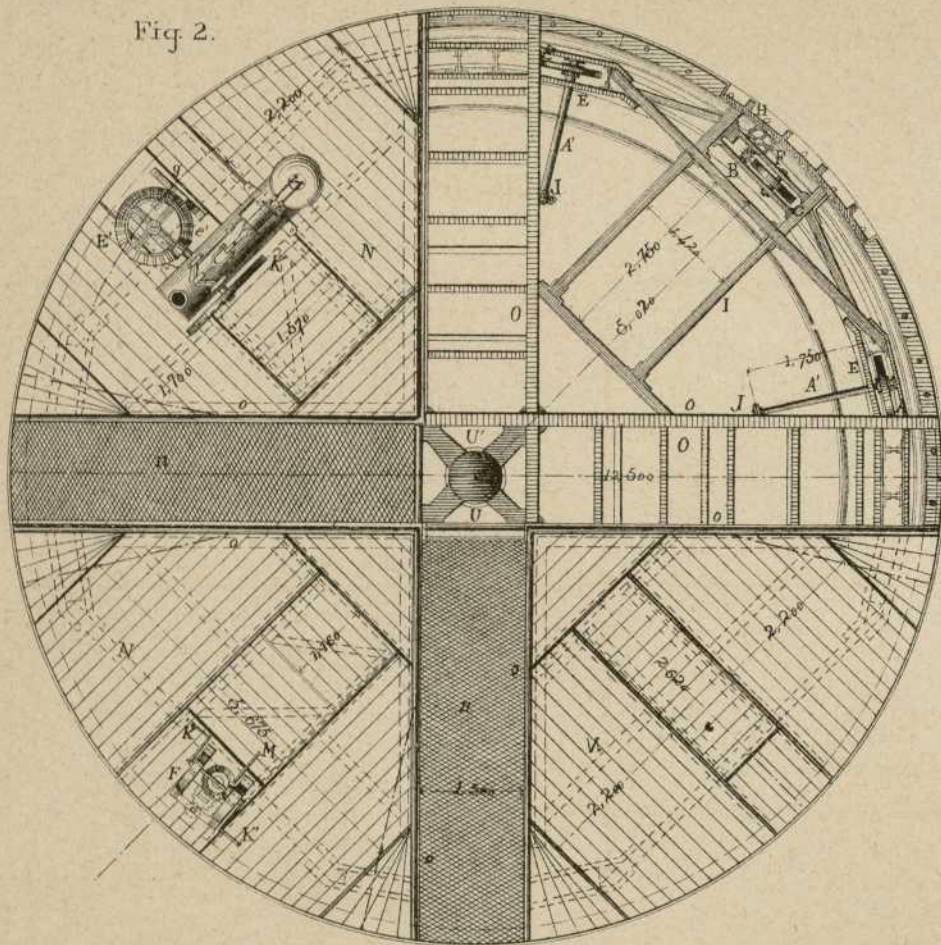


Fig. 4.

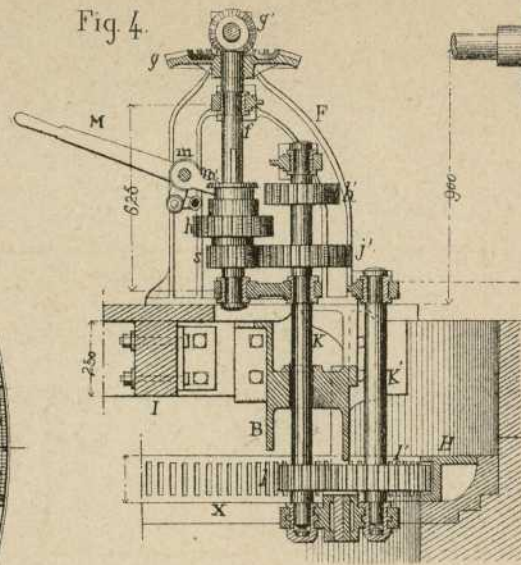


Fig. 3.

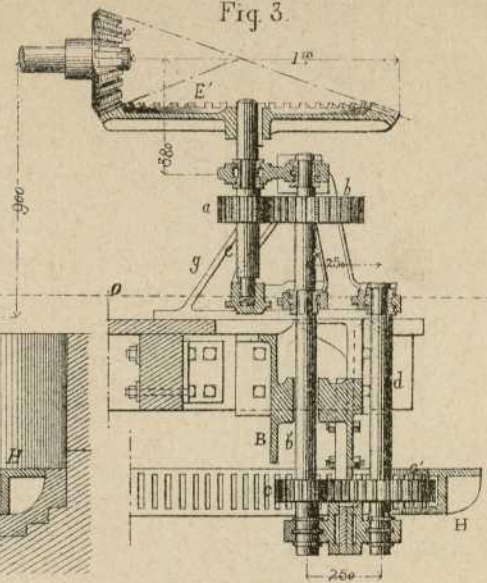


Fig. 8.

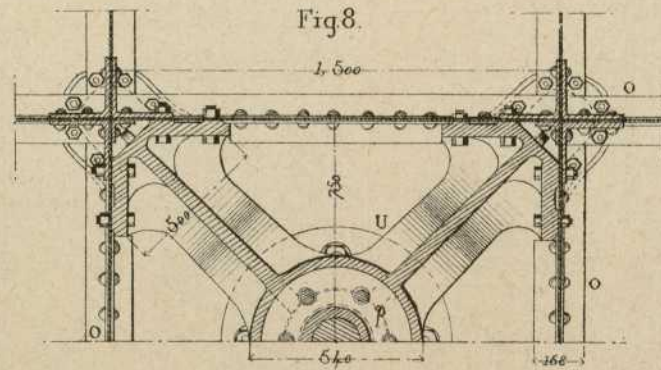


Fig. 6.

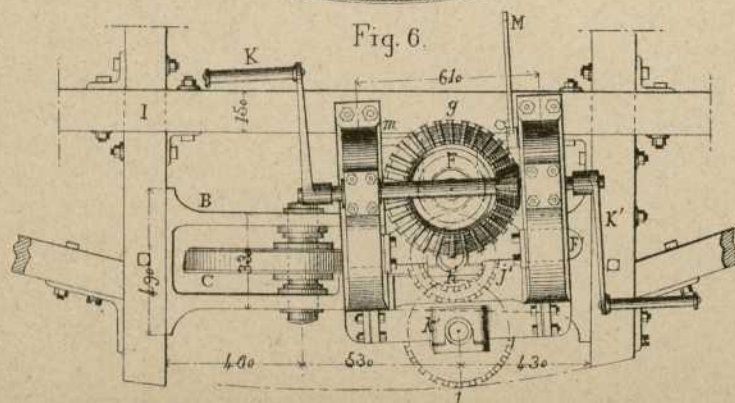


Fig. 12.

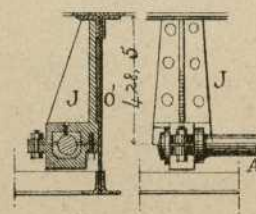
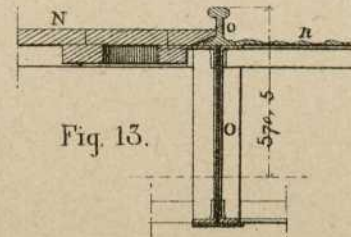
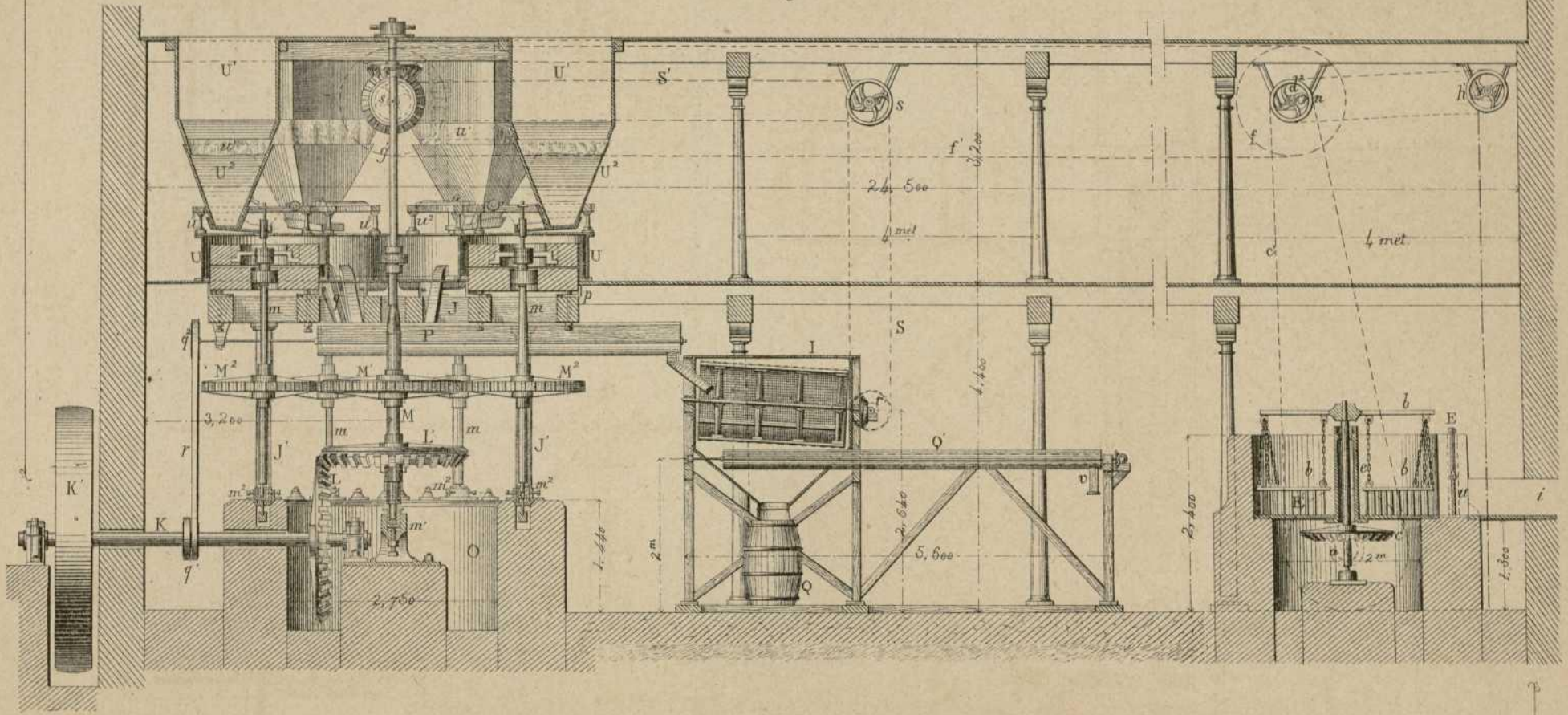


Fig. 13.



H.C.

Fig. 2.



Escala de 1/80.

H.C.

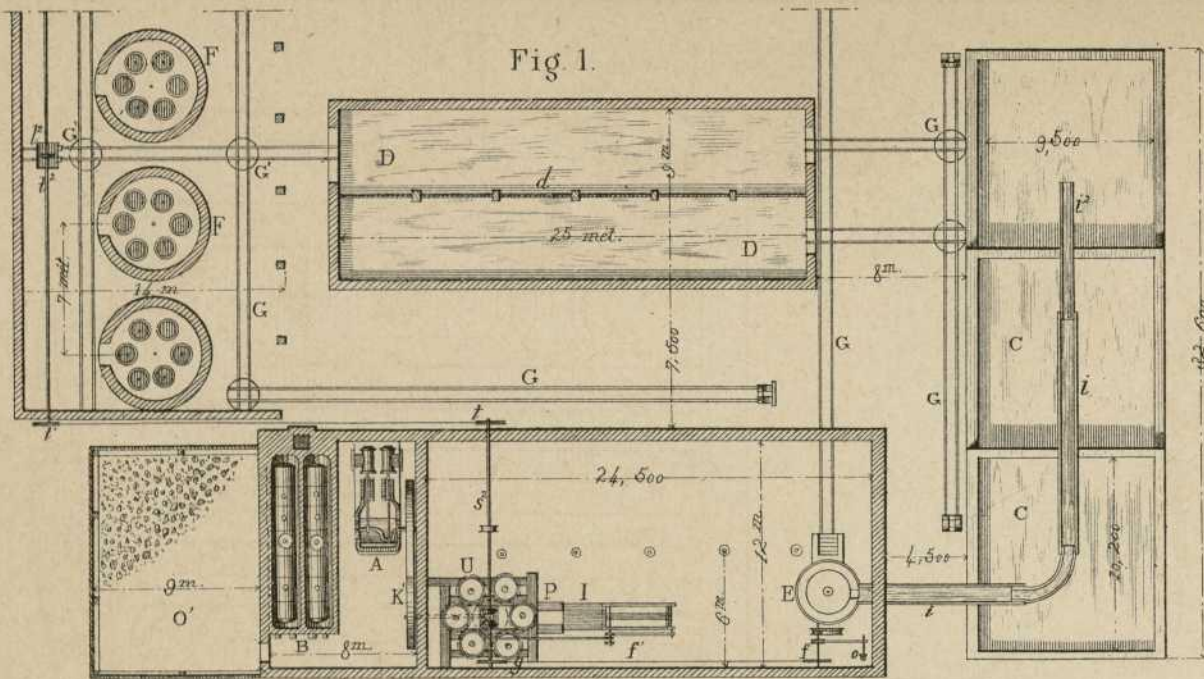


Fig. 1.

Escala de 1/400.

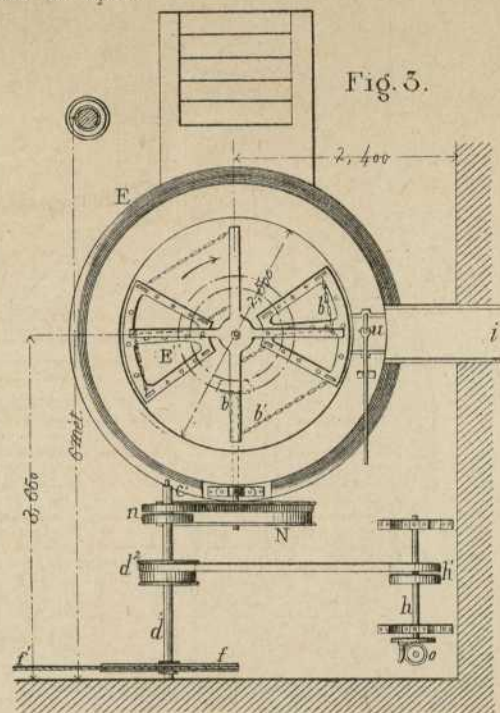


Fig. 3.

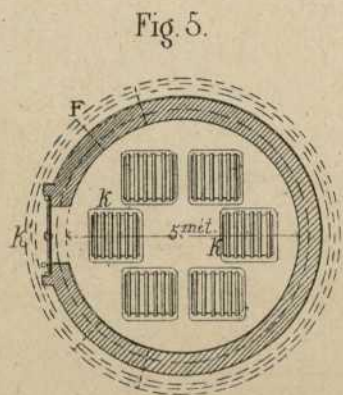


Fig. 5.

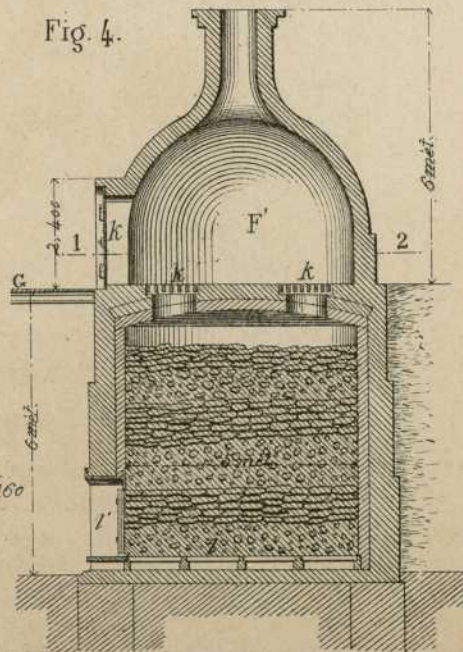


Fig. 4.

Escala de 1/100

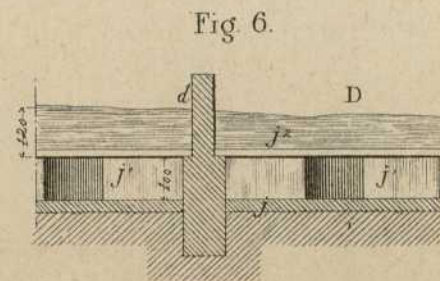


Fig. 6.

Escala de 1/20.

Fig. 1.

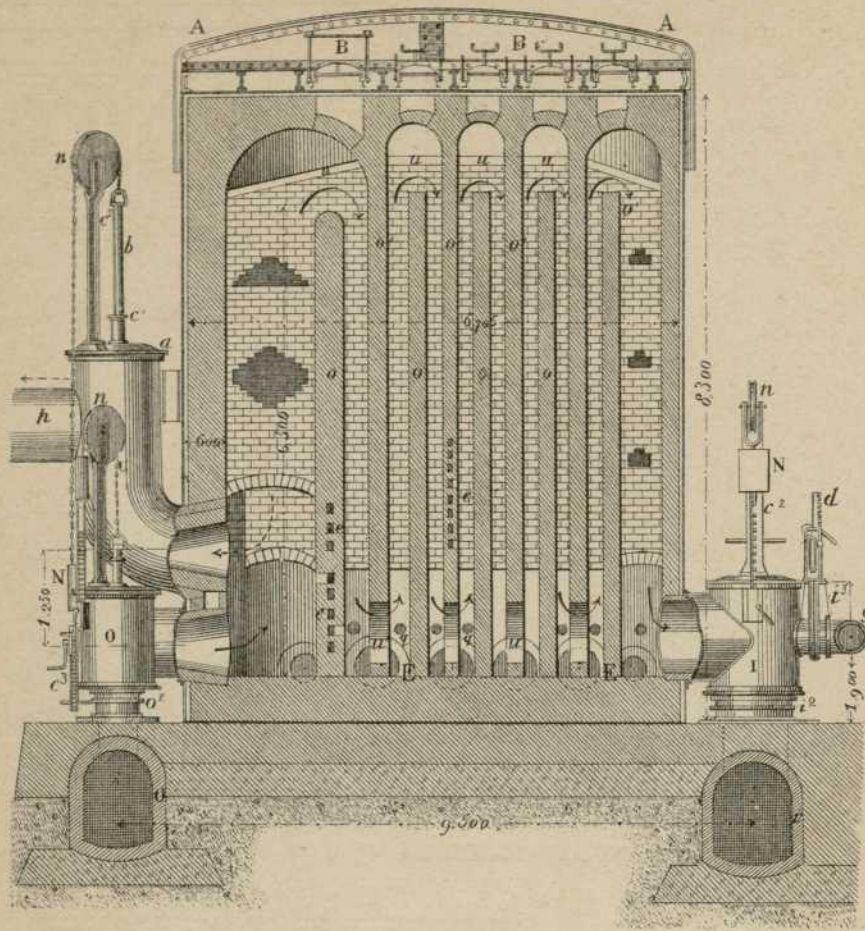


Fig. 3.

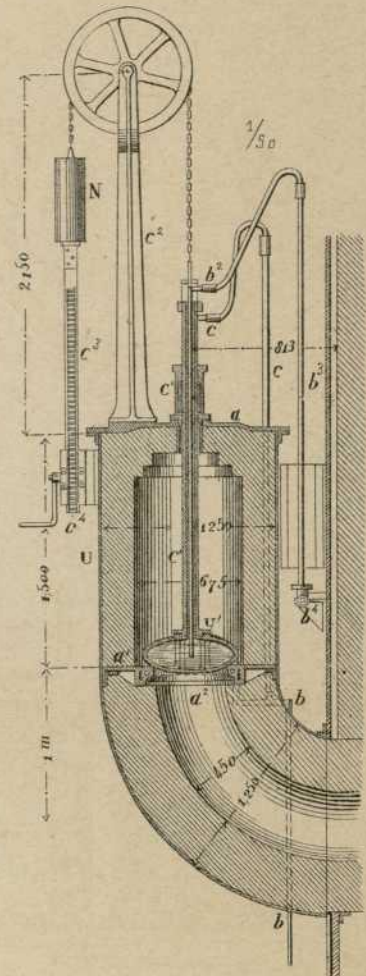


Fig. 2.

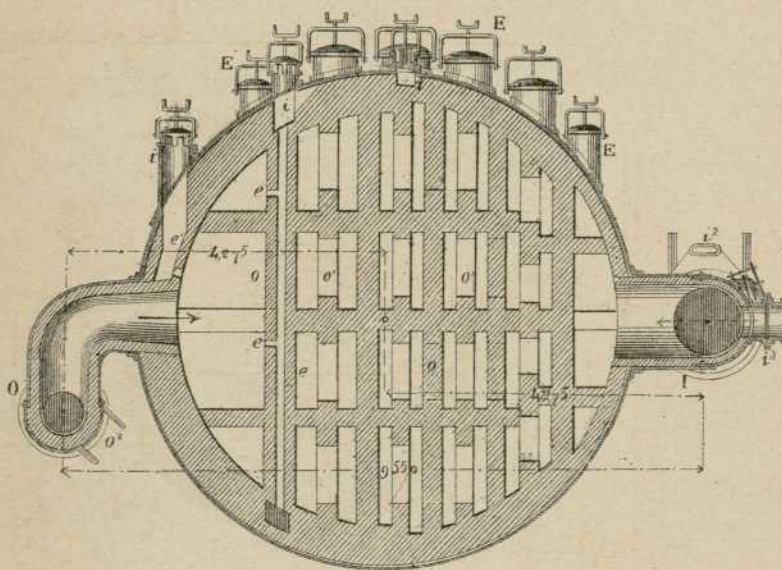
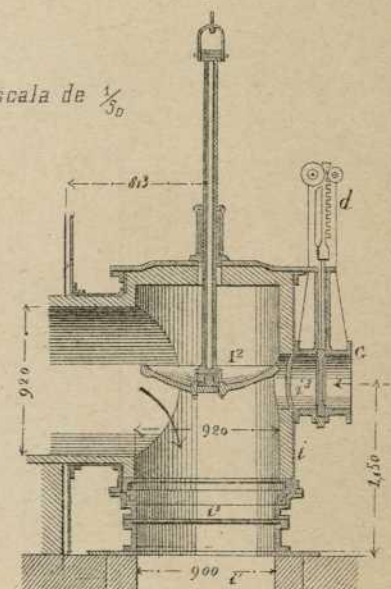


Fig. 4.

Escala de 1/30



Escala de 1/100 por las Figs 1 y 2

J. G.

Nacente, editor.

Paseo de Gracia, 149.

Fig. 5.

Escala de 1/200

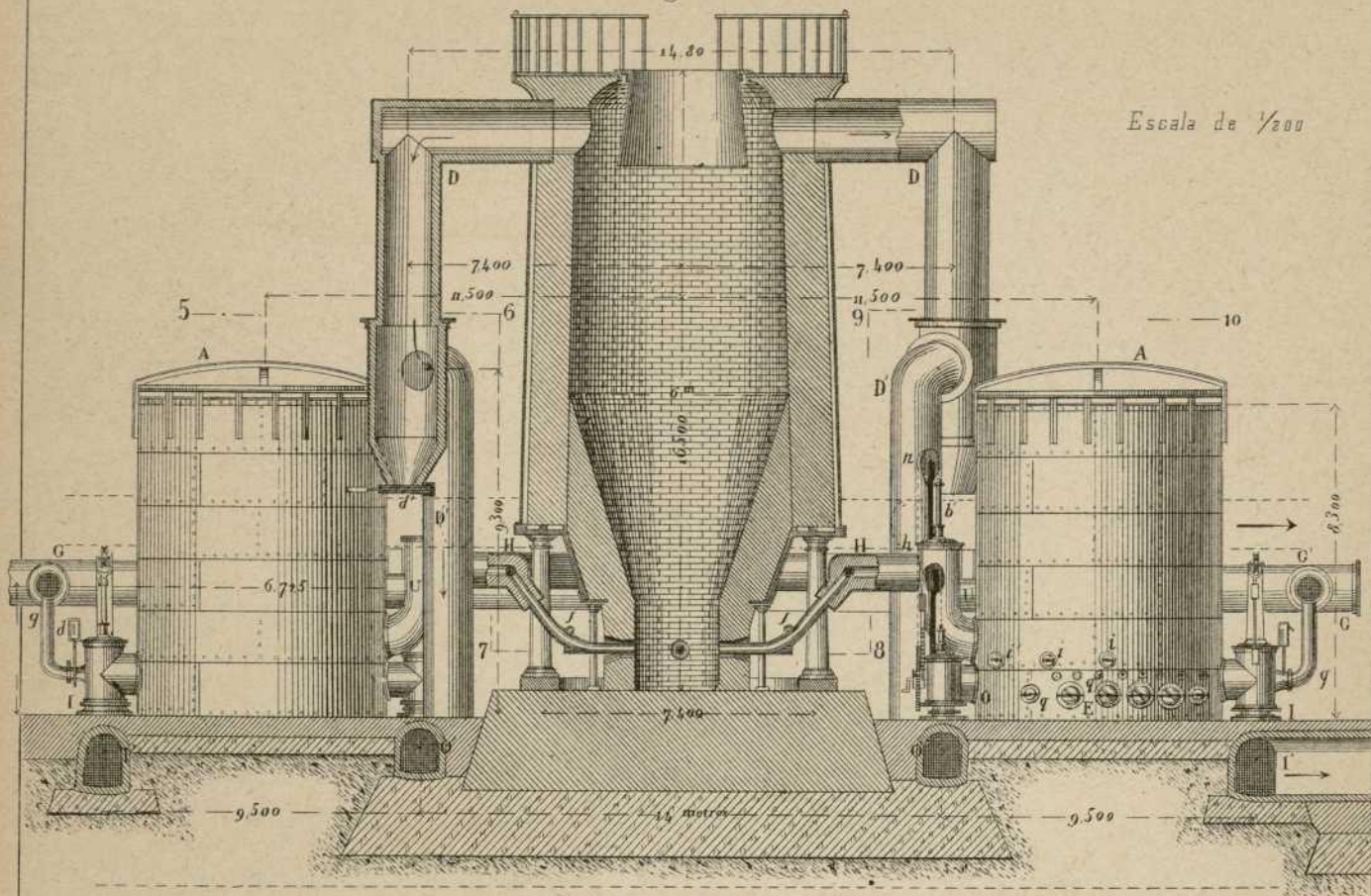


Fig. 6.

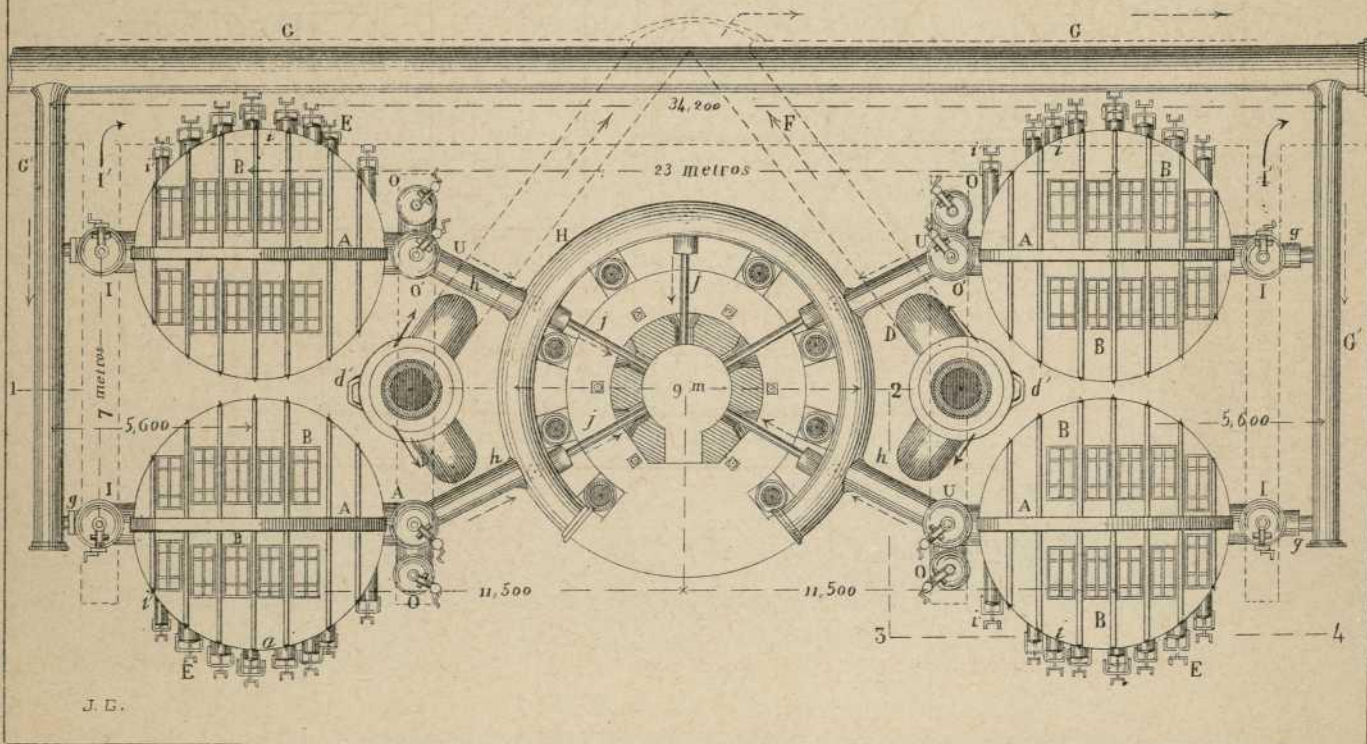


Fig. 3.

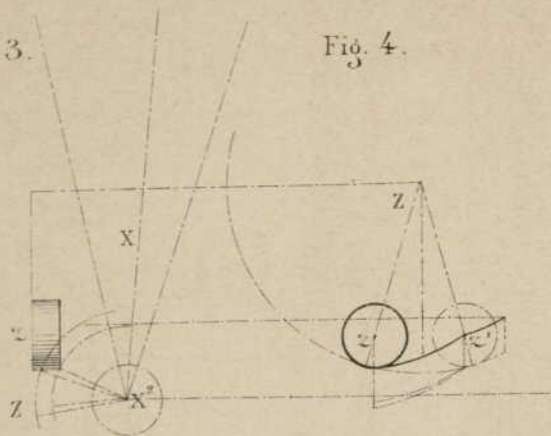


Fig. 4.

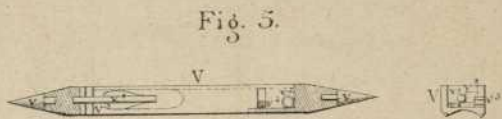


Fig. 1.

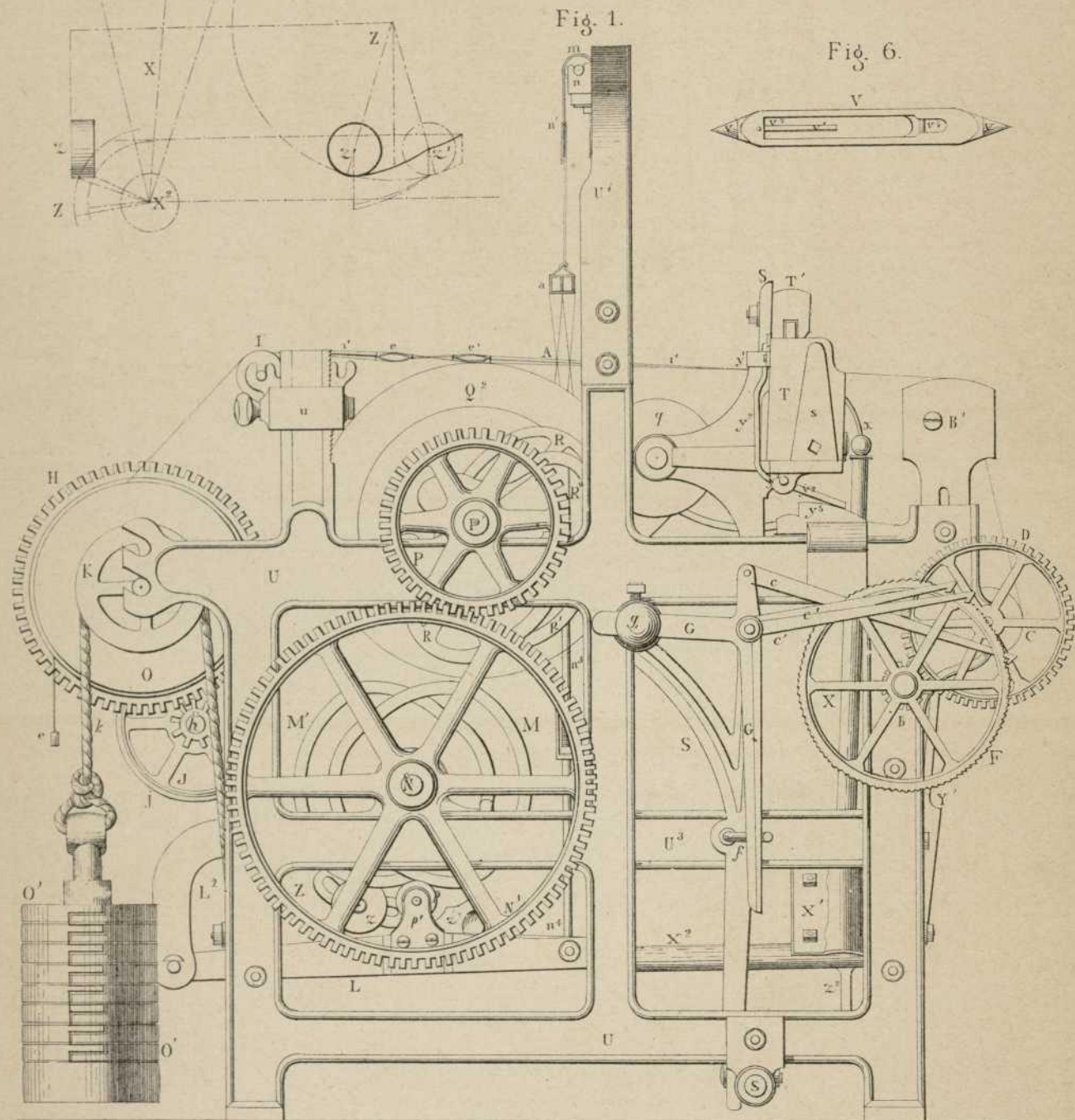
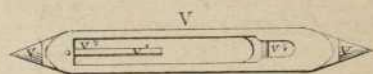
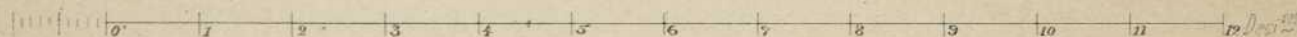
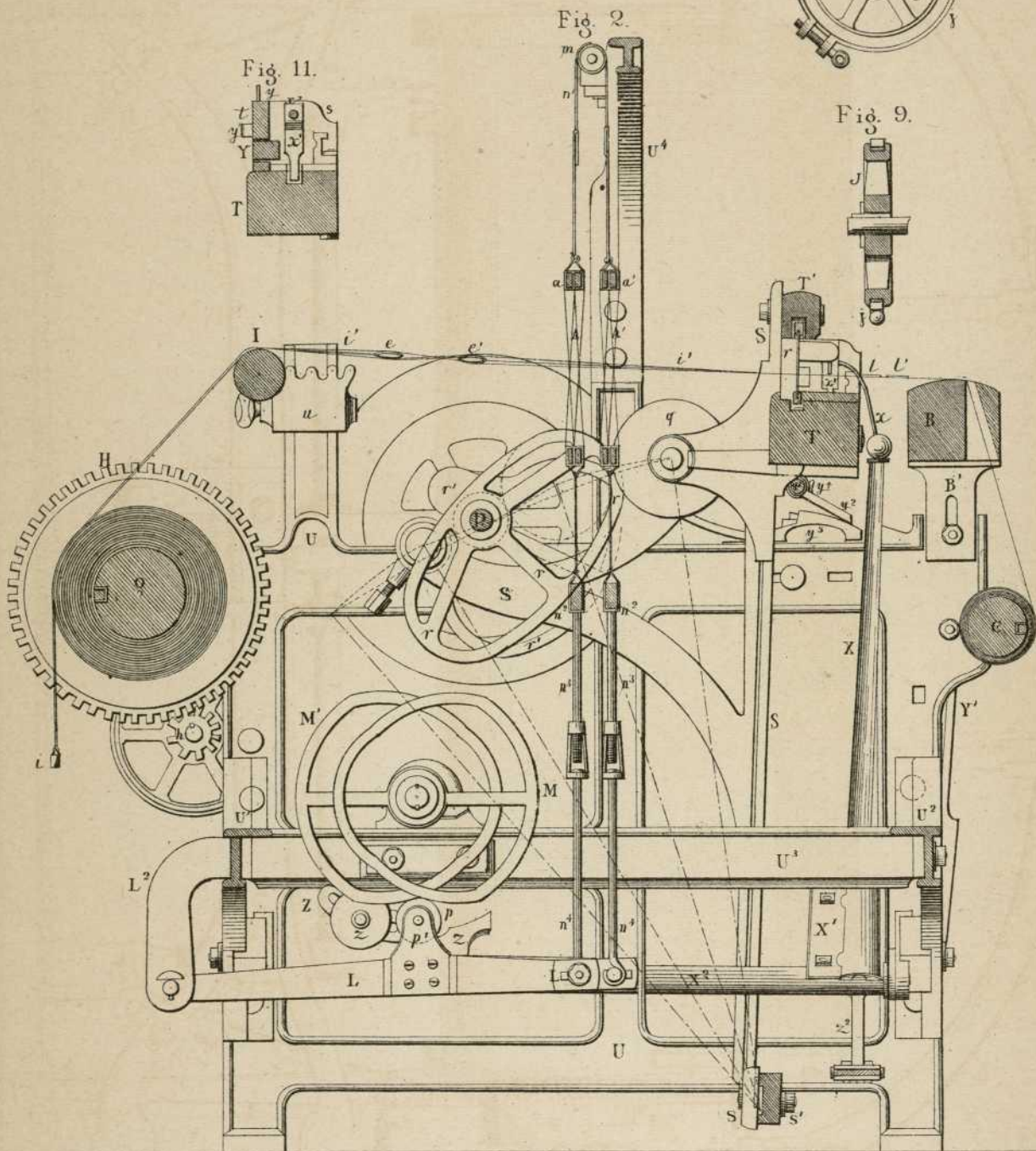
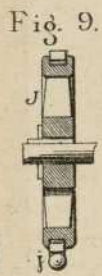
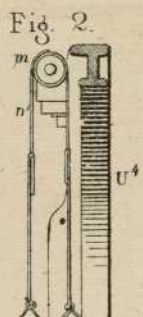
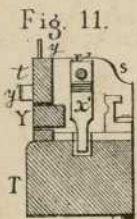
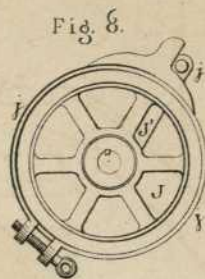
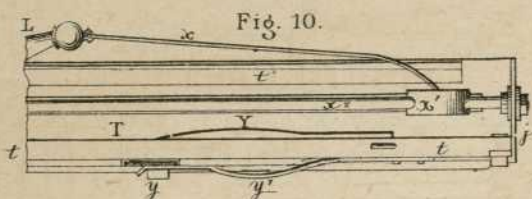


Fig. 6.

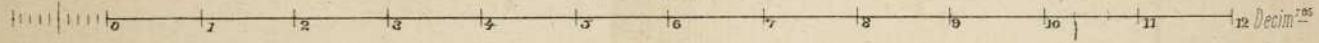


Escala de 1/8





Escala de 1/8



⊕

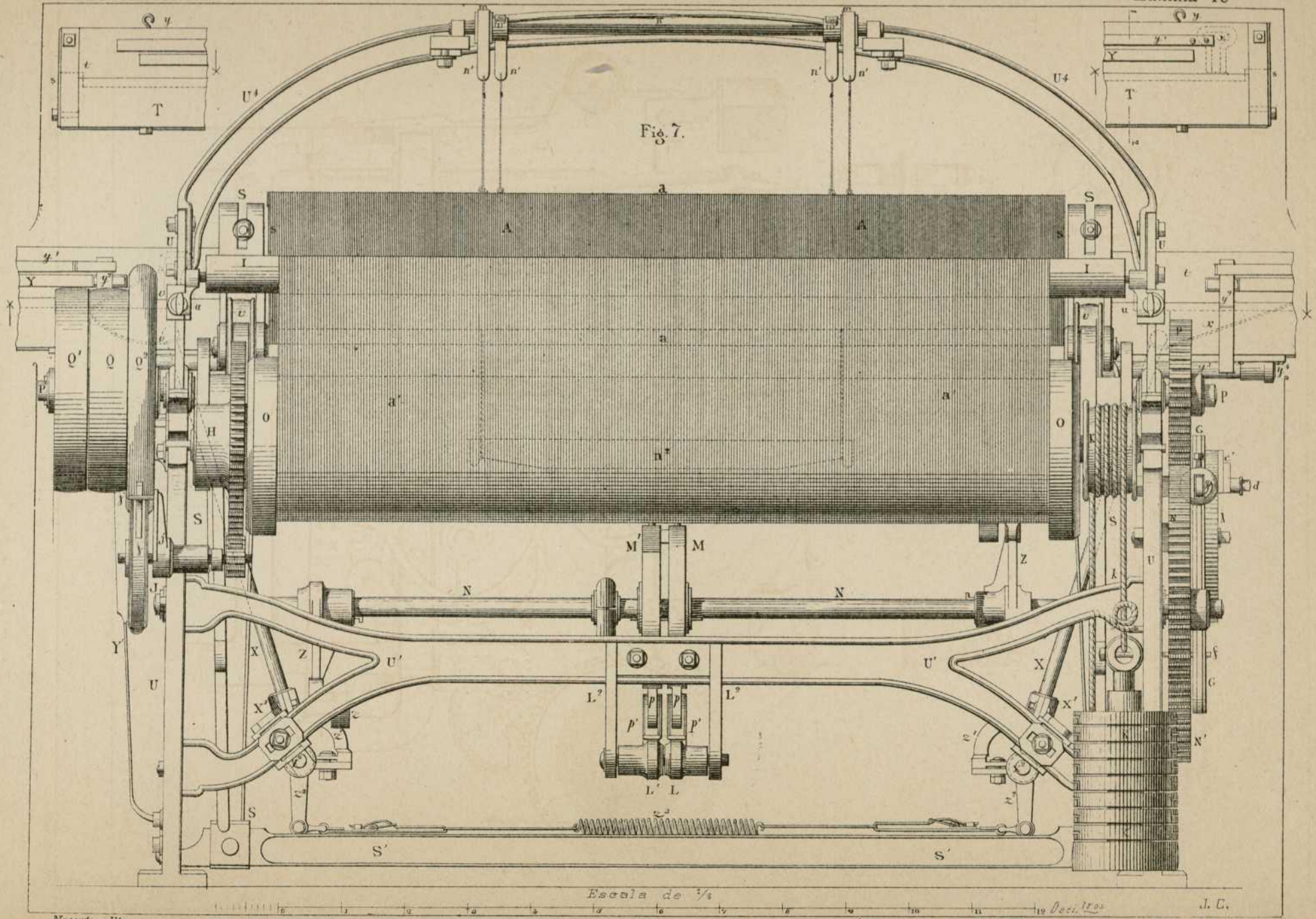
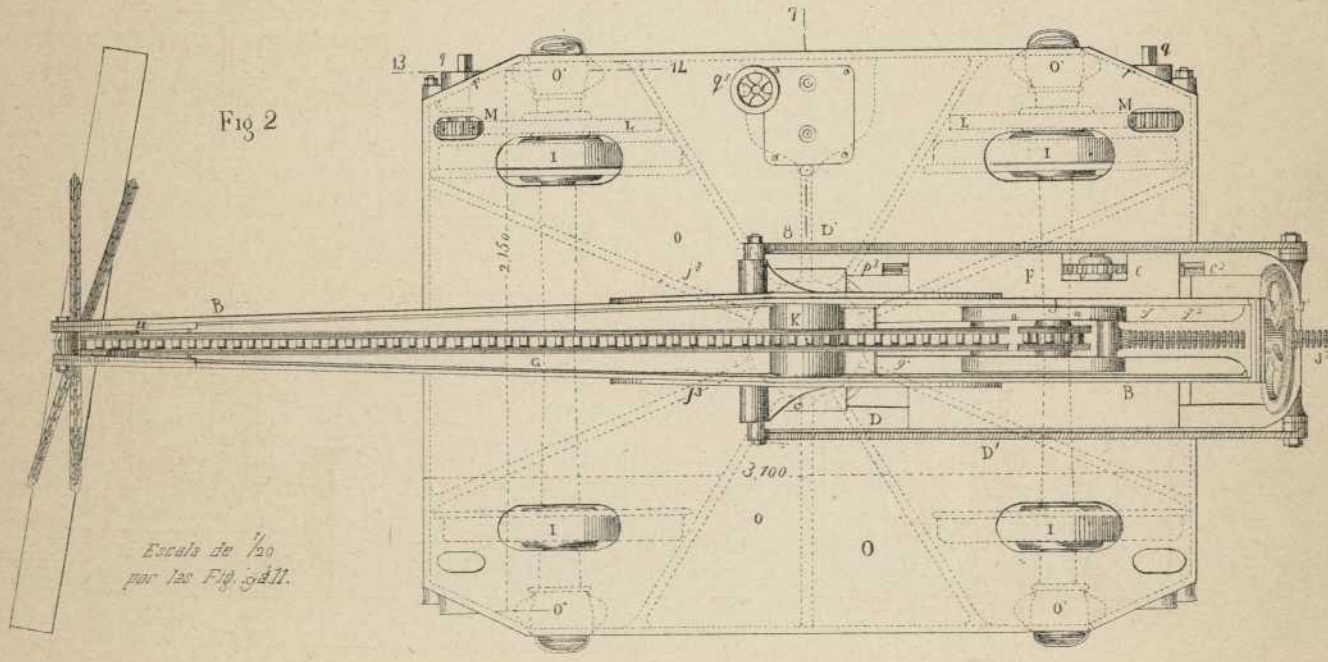
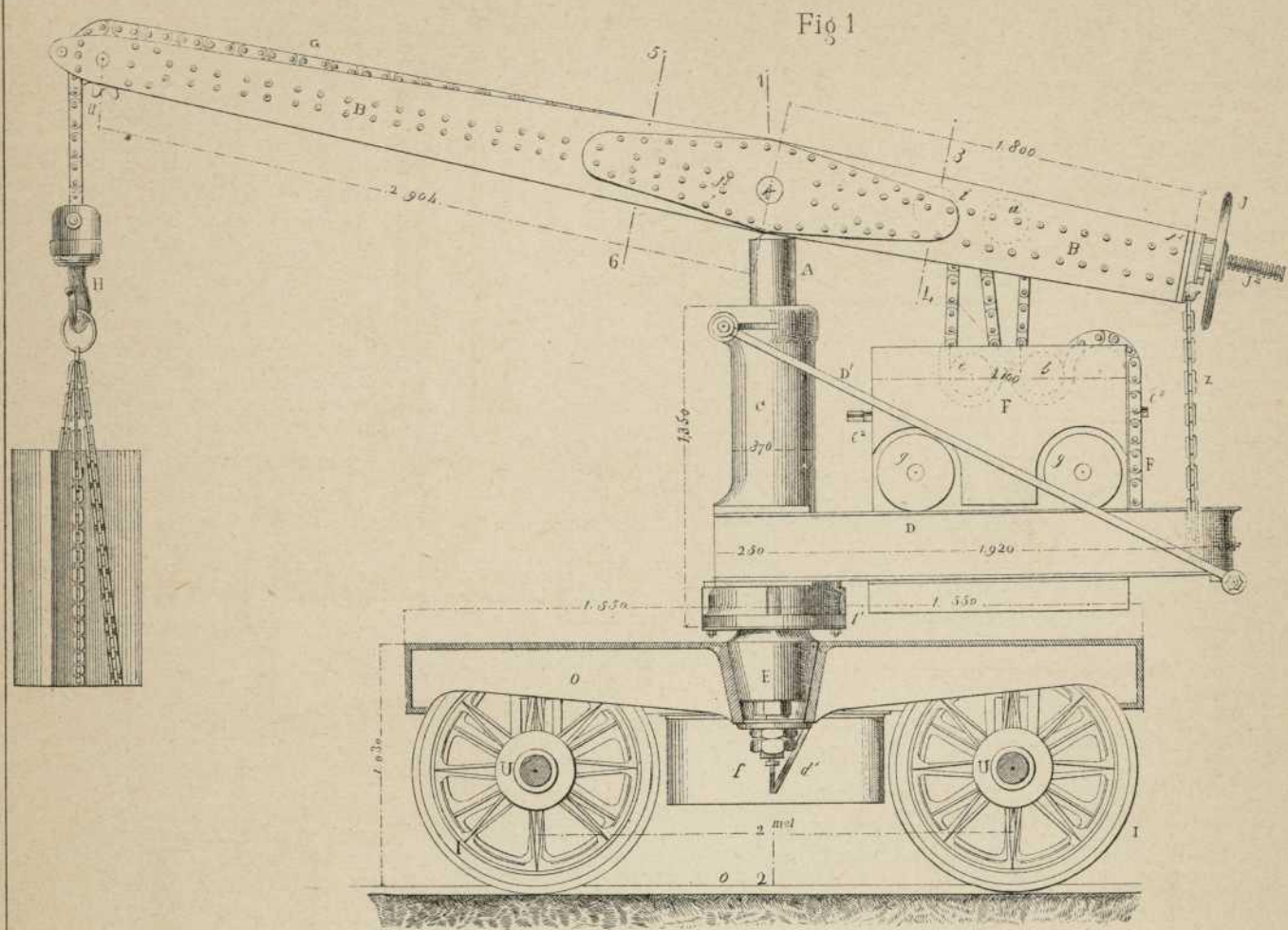


Fig. 7.

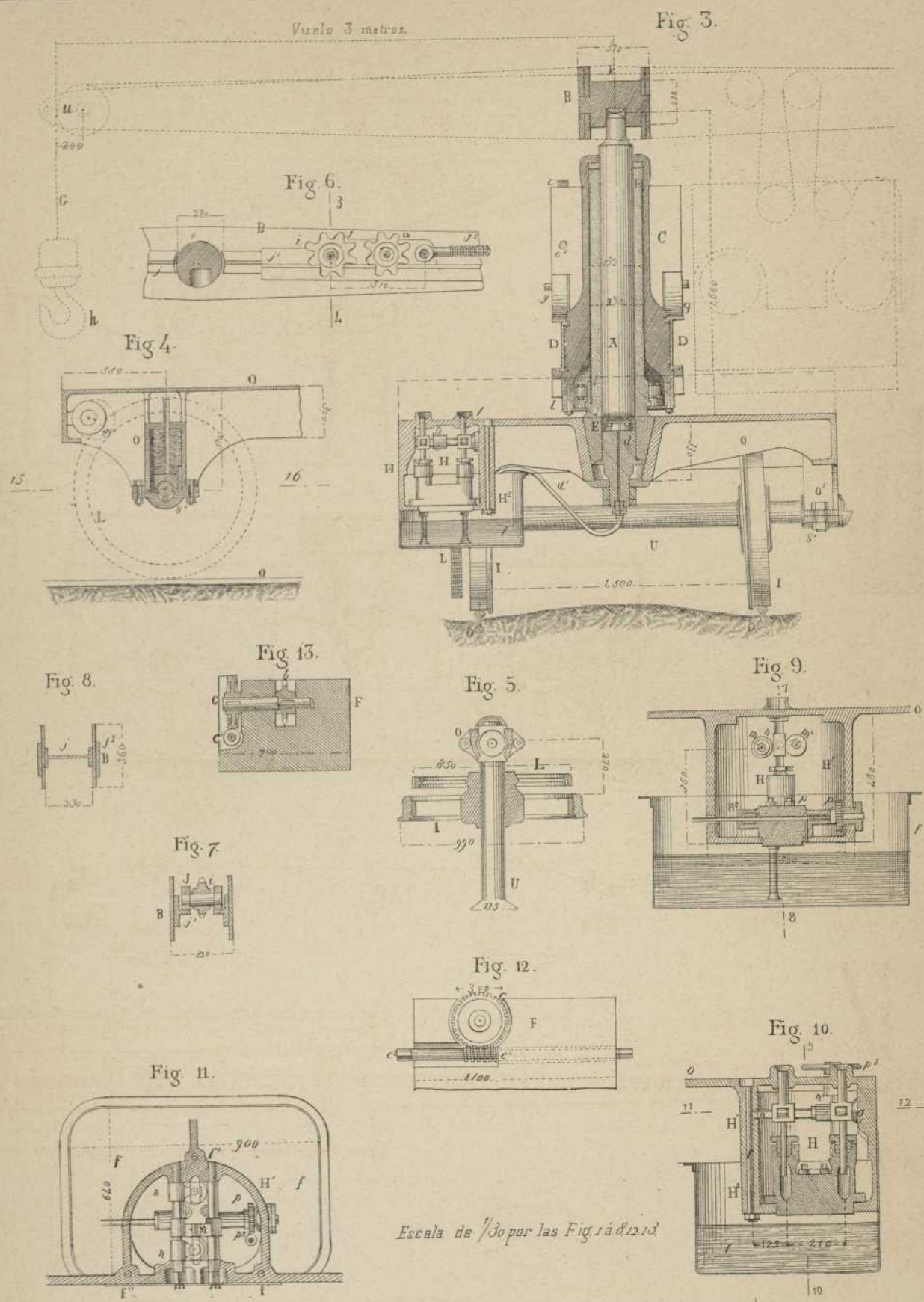
Escala de 3/4

Deci. 1893

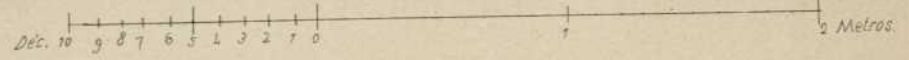
J. C.

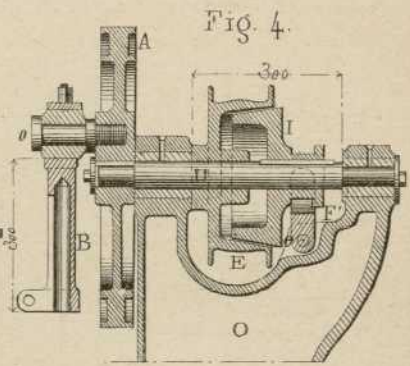
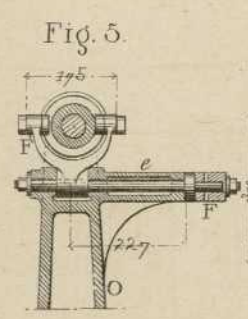
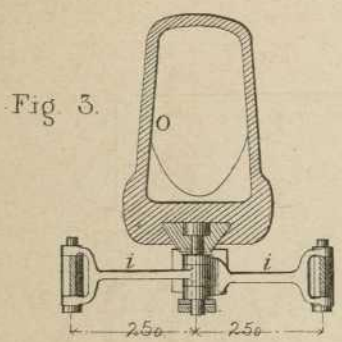
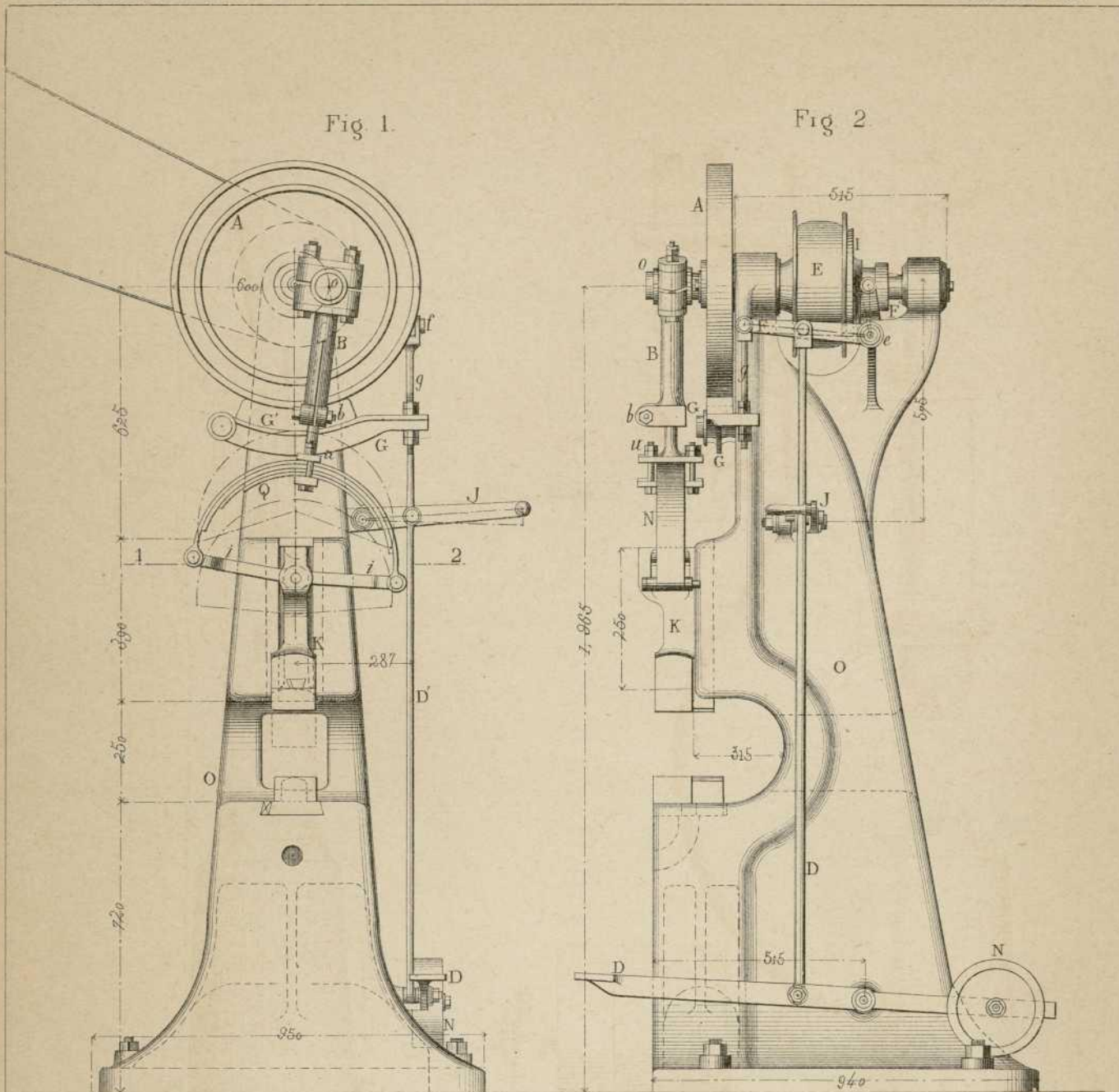


Escala de 1/20
por las Fig. 3 y 4.



Escala de 1/30 por las Fig. 1 a 12.





Escala de 1/15.

B. C.

Fig. 8

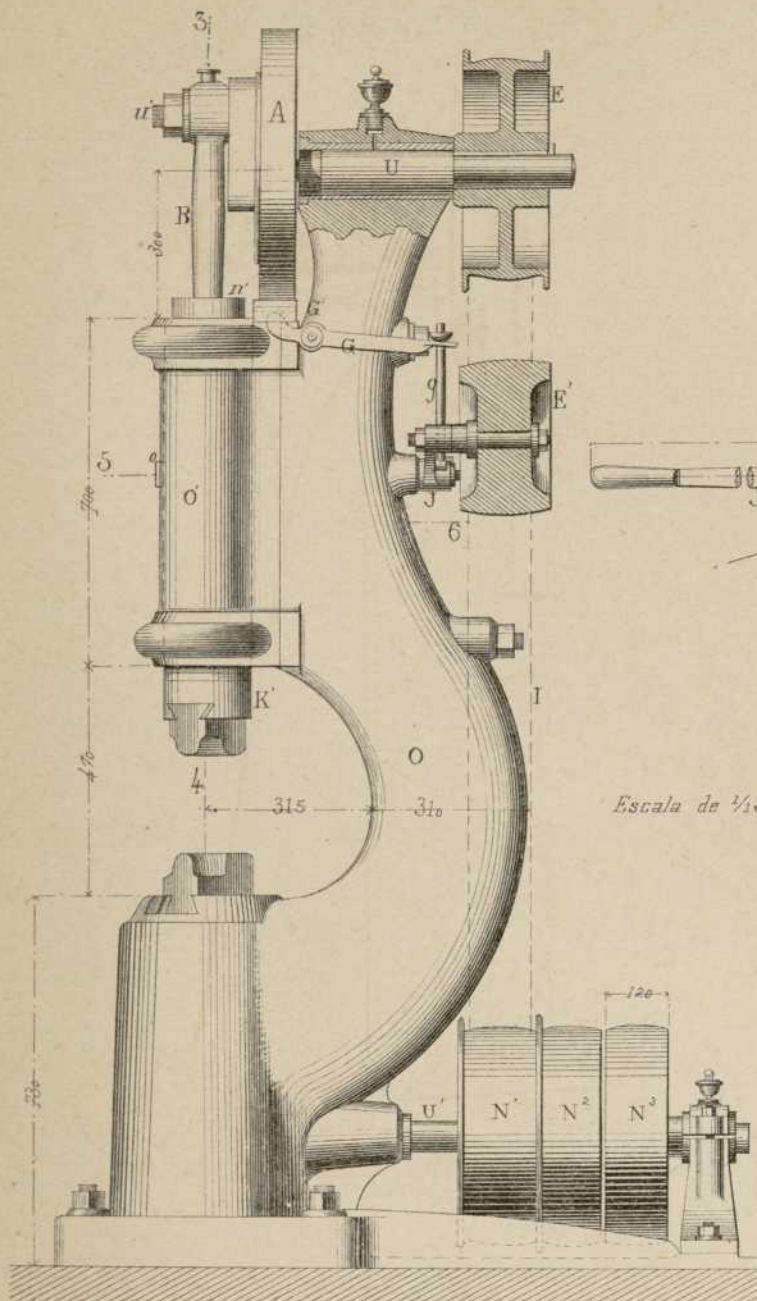
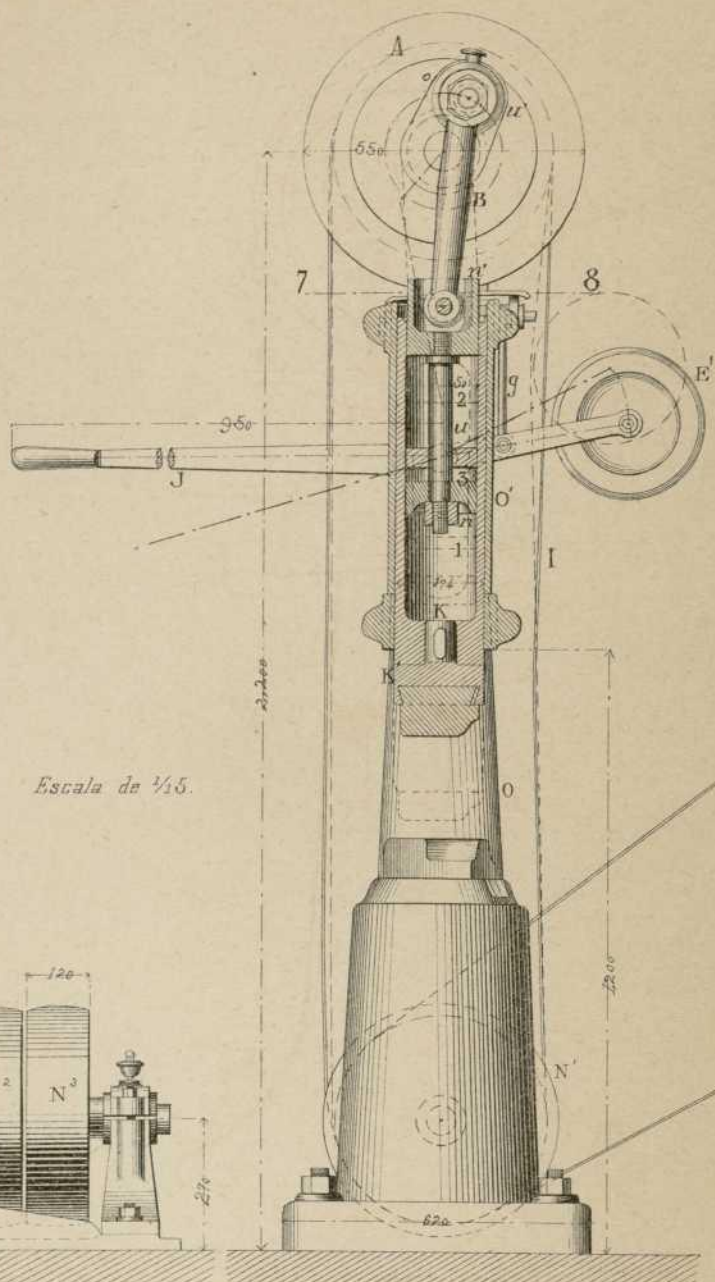


Fig. 6



Escala de 1/45.

Fig. 9

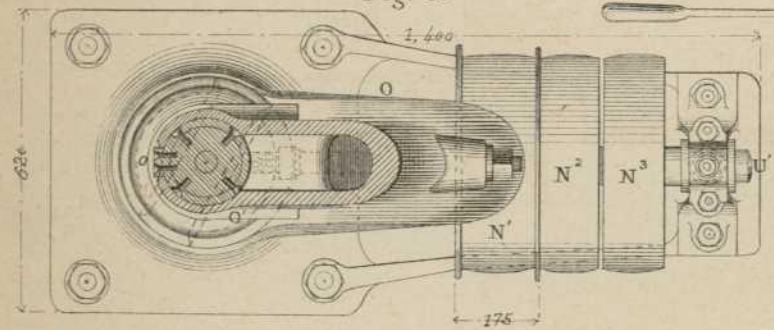
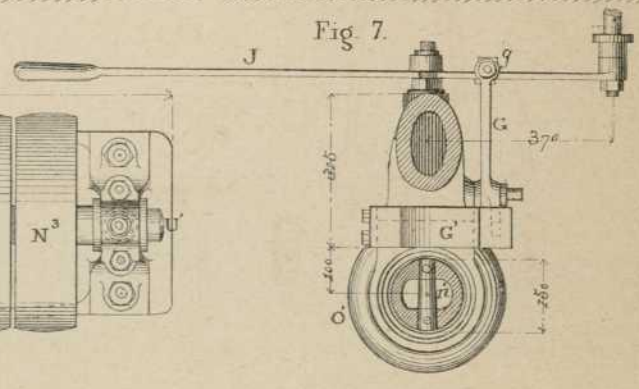


Fig. 7



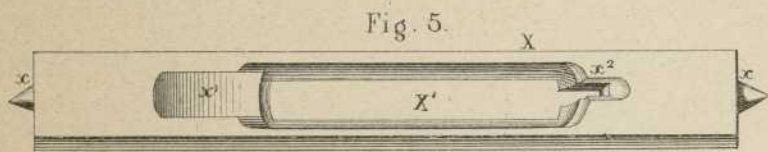
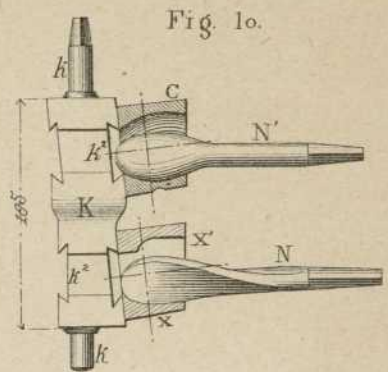
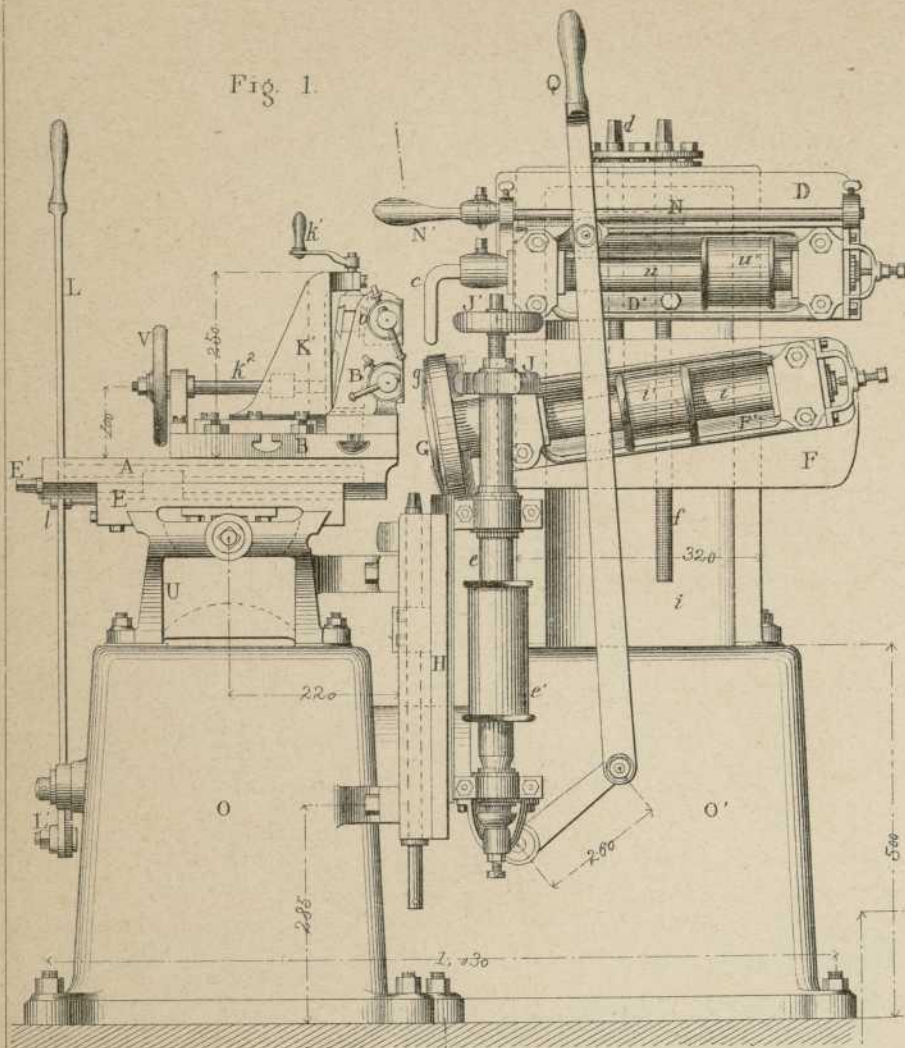


Fig. 5.

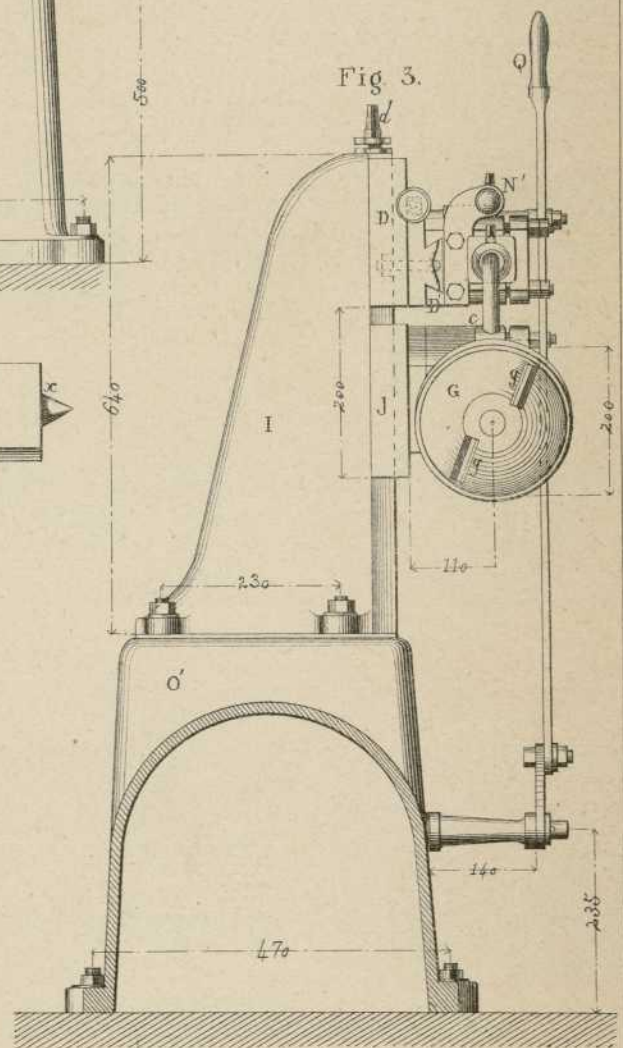


Fig. 3.

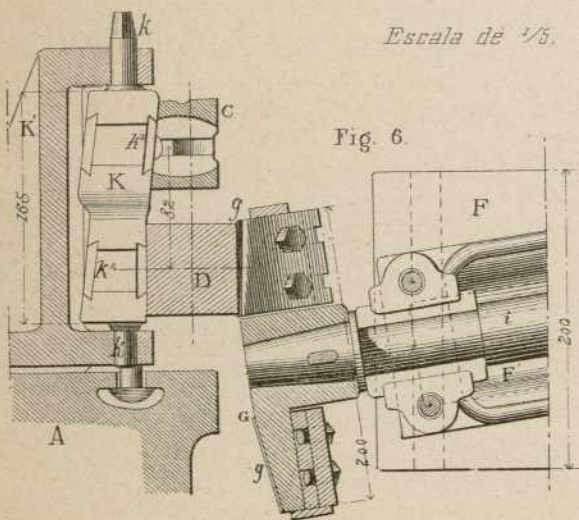


Fig. 6.

Escala de 1/5.

B. C.

Fig. 8.

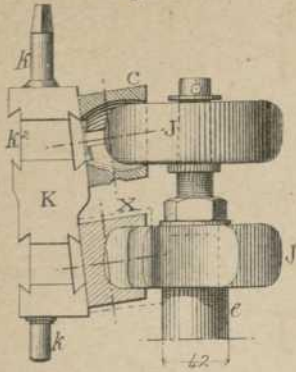
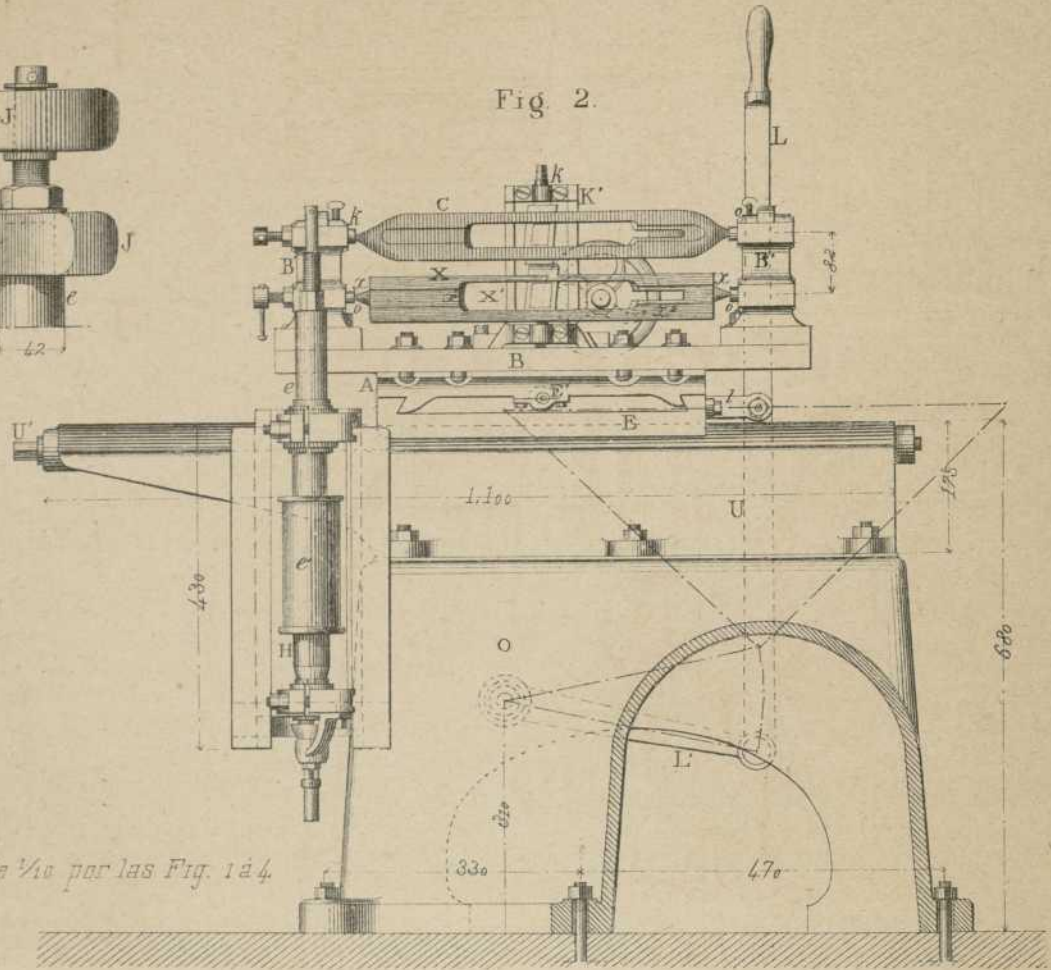
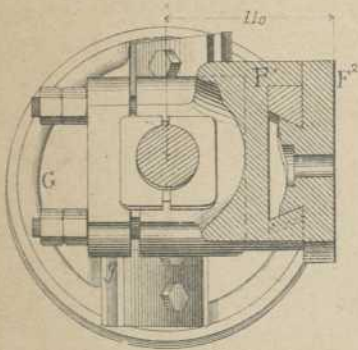


Fig. 2.



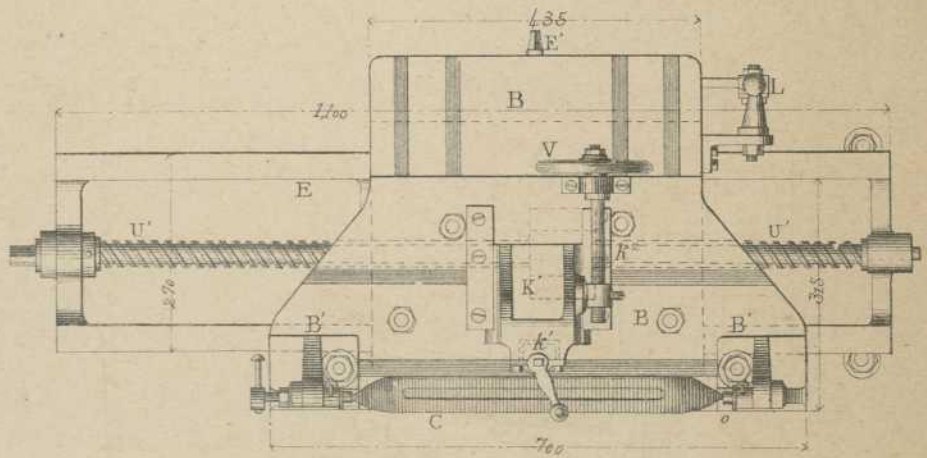
Escala de 1/10 por las Fig. 1 a 4.

Fig. 7.

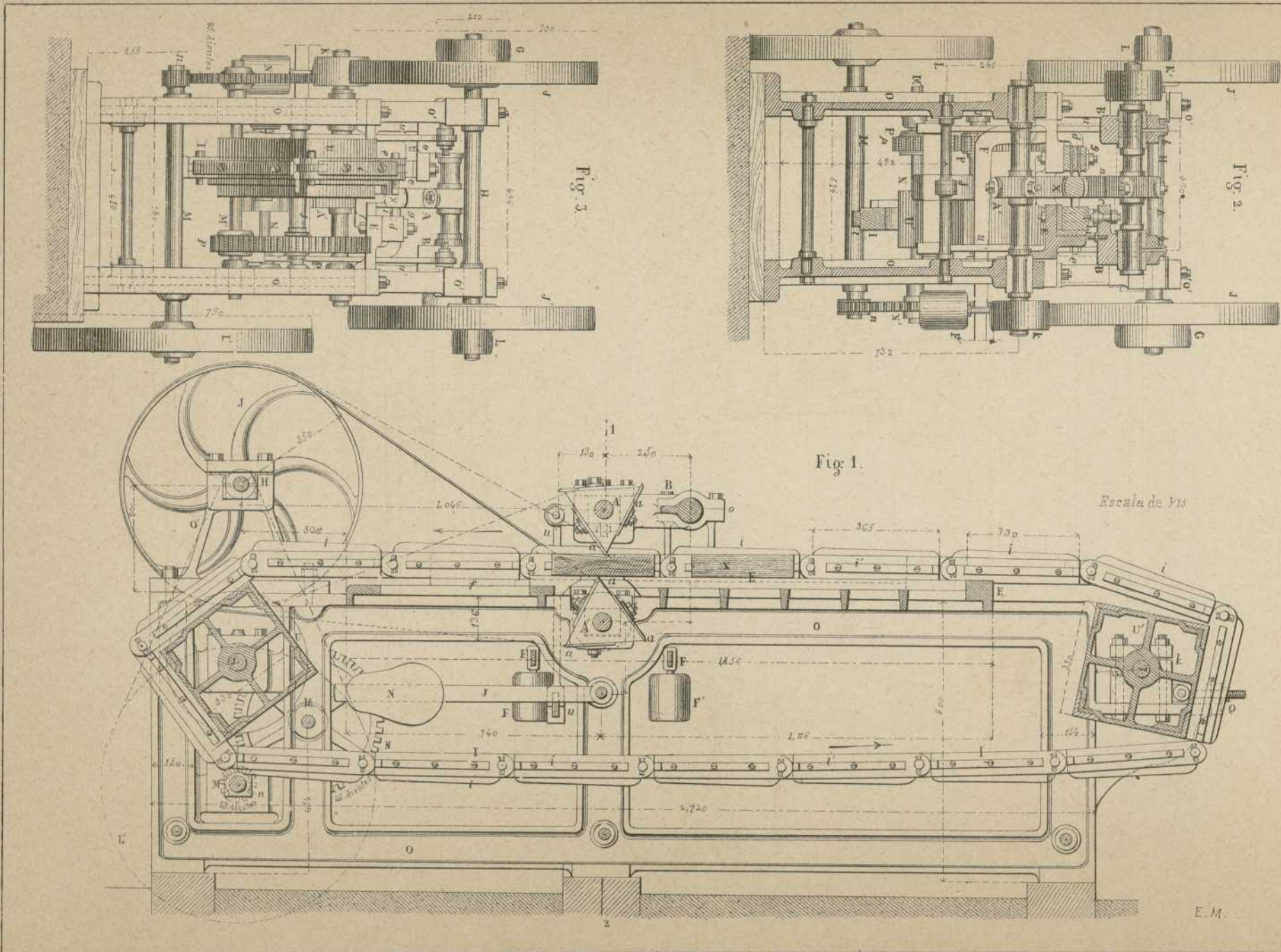


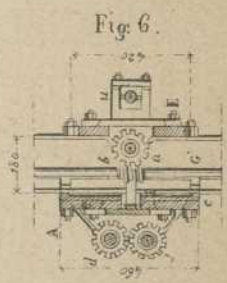
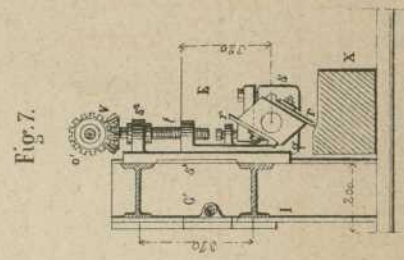
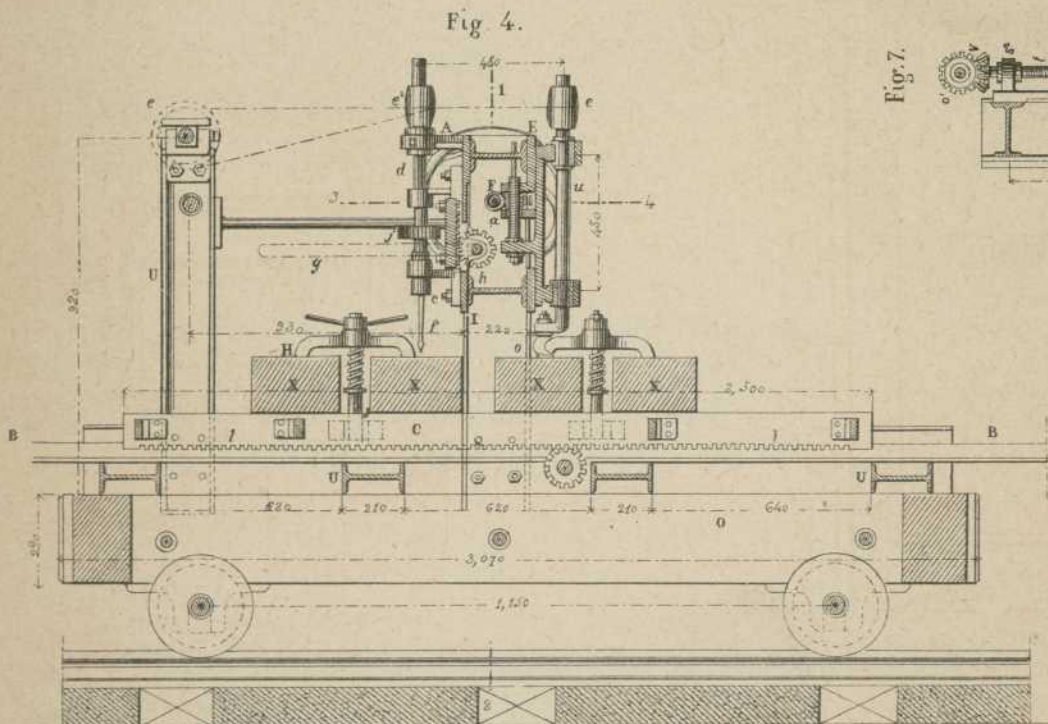
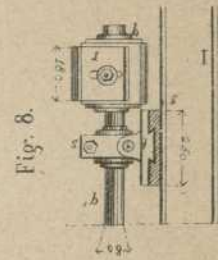
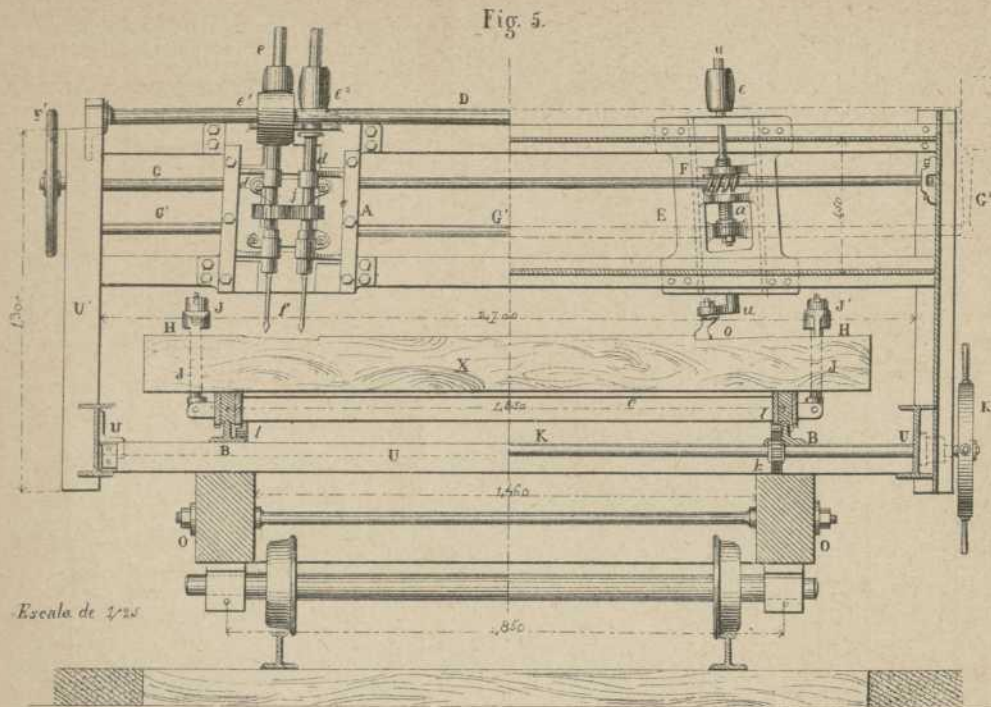
Escala de 1/5.

Fig. 4.

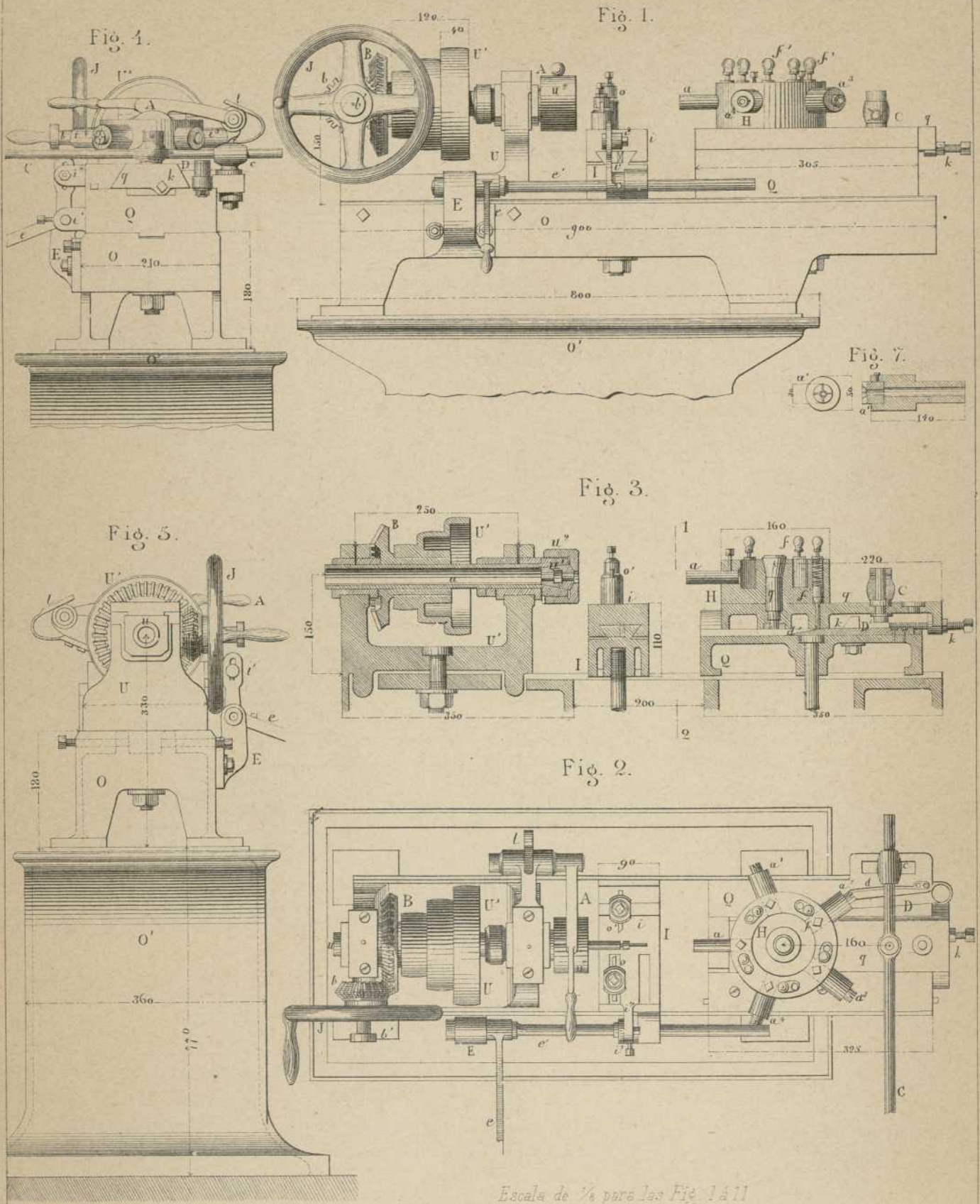


B. E.



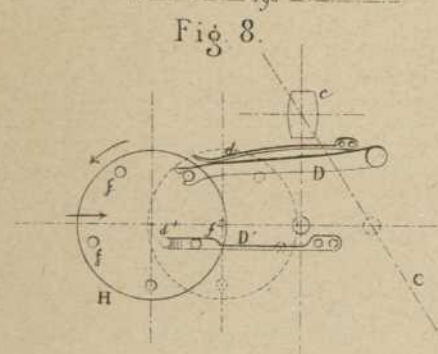
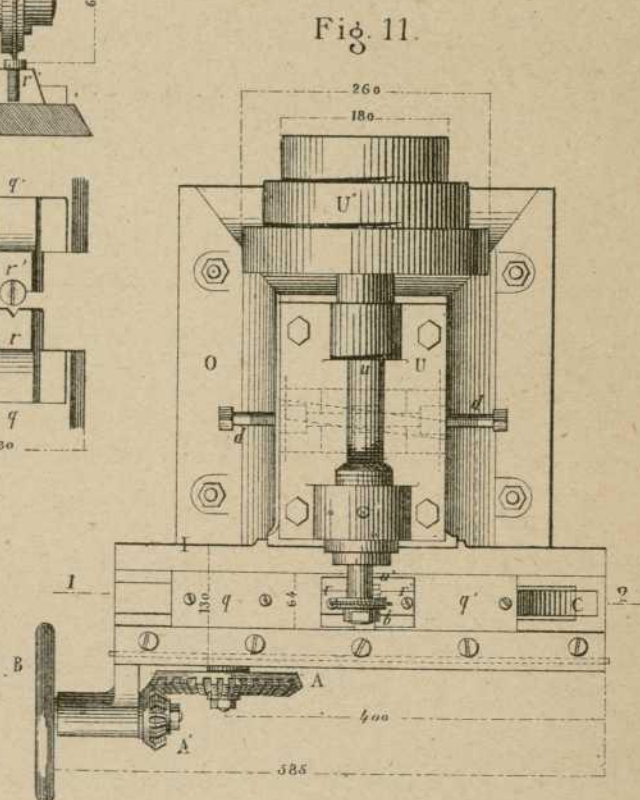
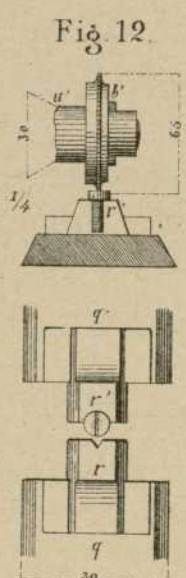
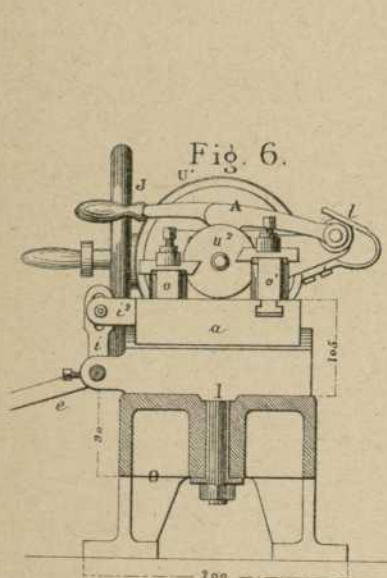
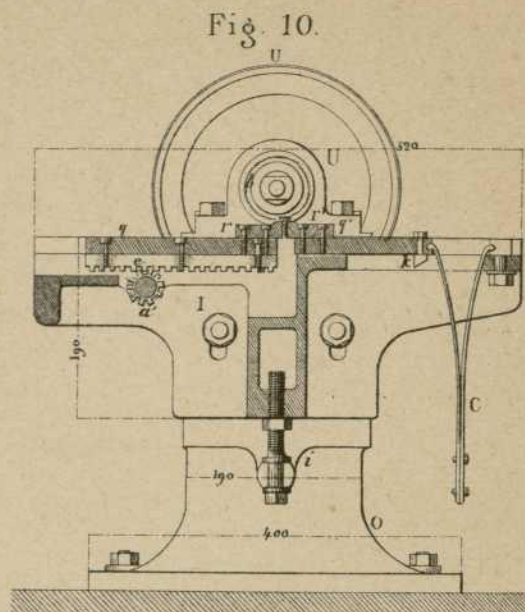
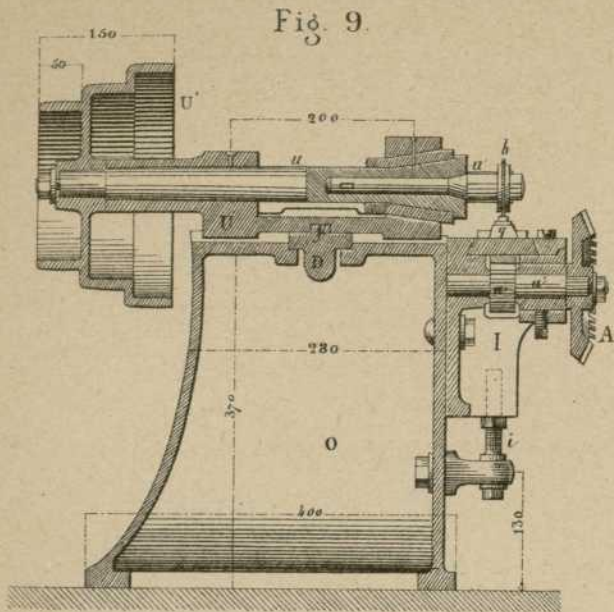


E.M.

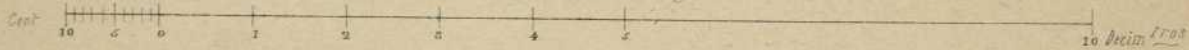


Escala de 1/4 para las Fig 1 á 11

10 0 1 2 3 4 5 6 7 8 9 10 Decímetros.



Escala de 1/2 para las Fig. 1 á 11



Escala de 1/20 por las Fig 1 à 3.

Fig. 1.

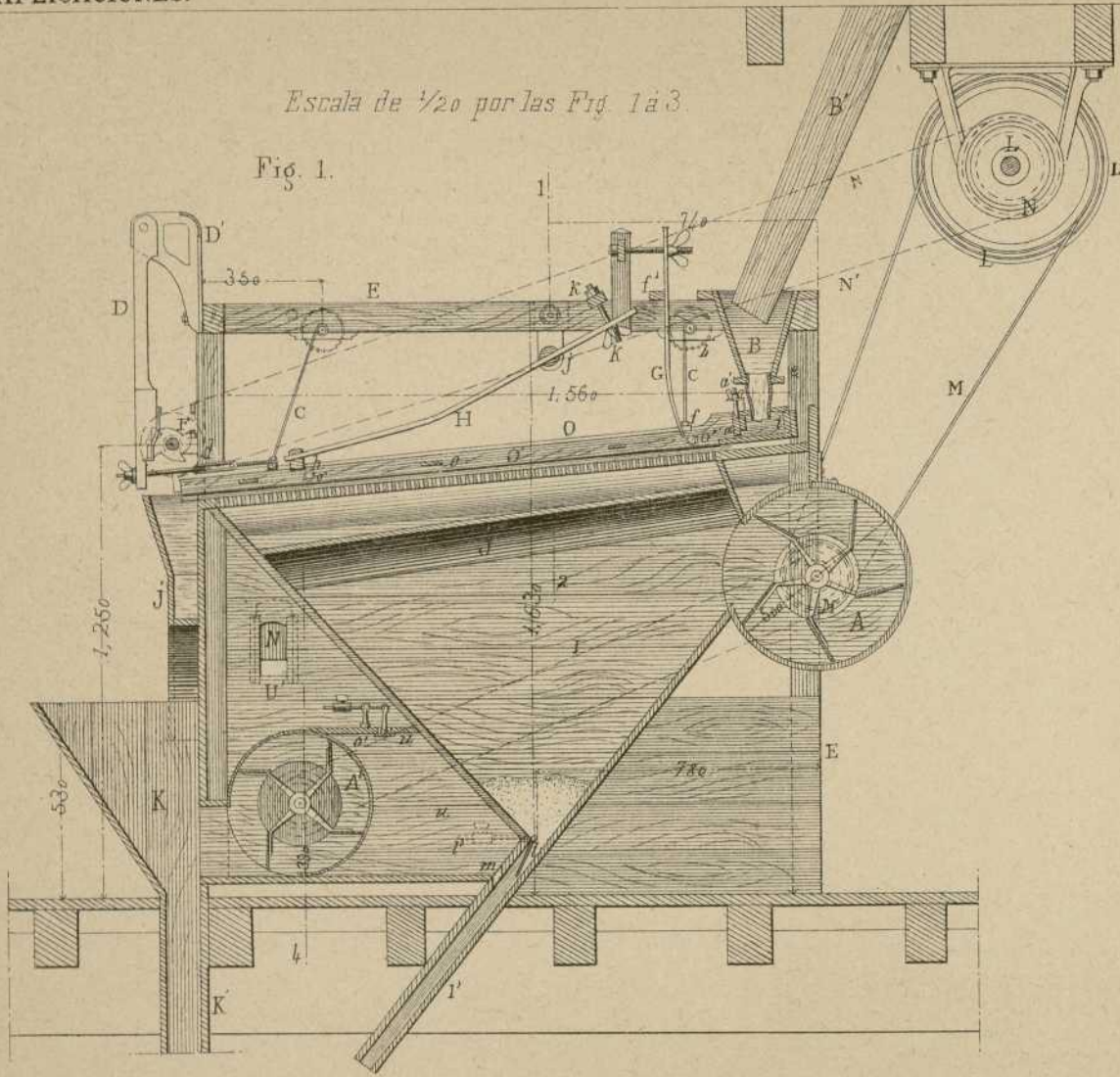


Fig. 2.

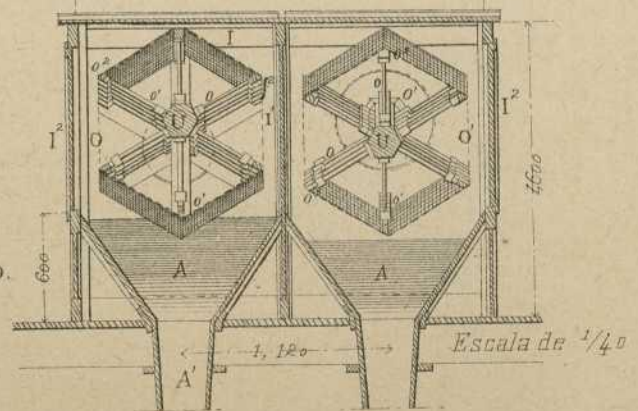
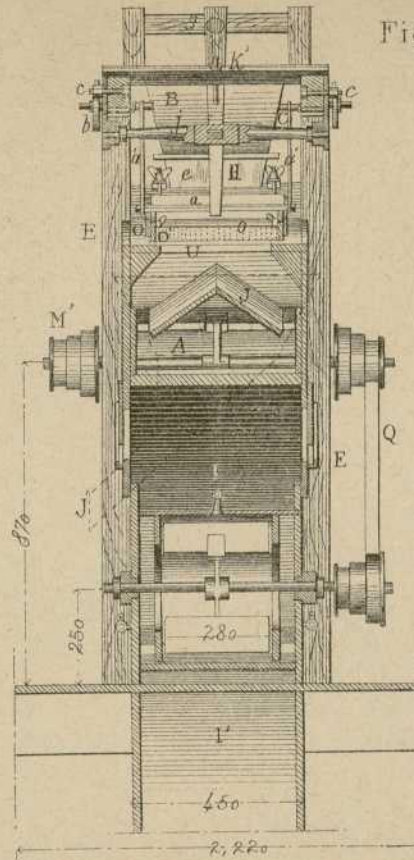


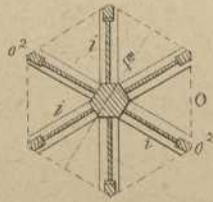
Fig. 10.

Escala de 1/40

Fig. 6.

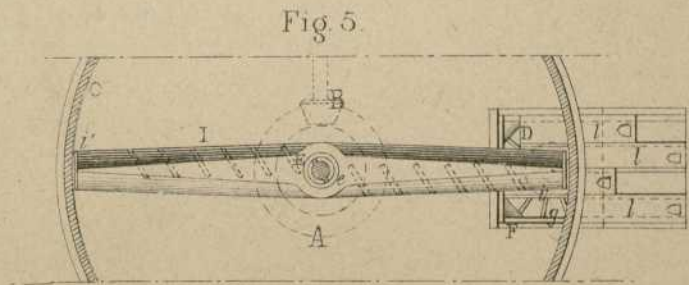
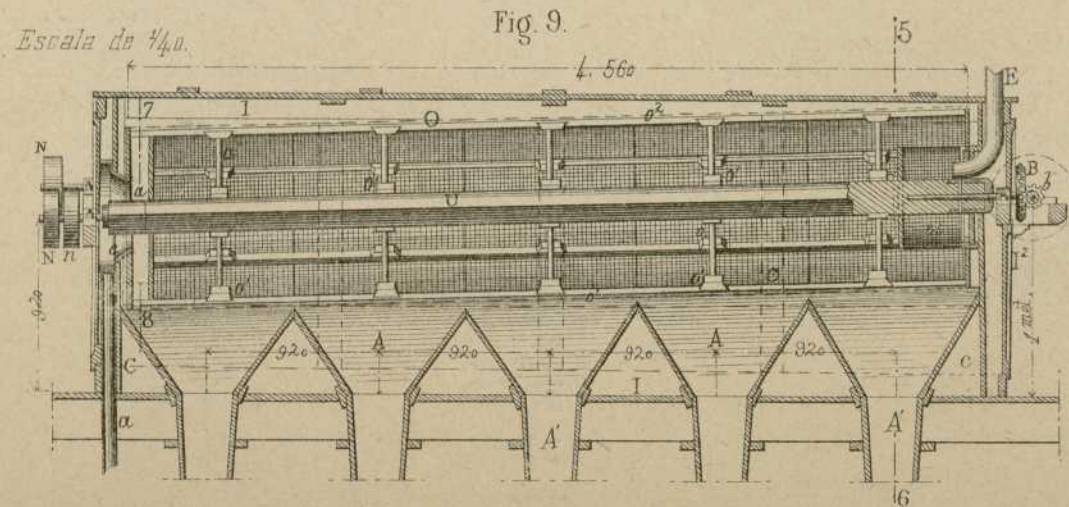
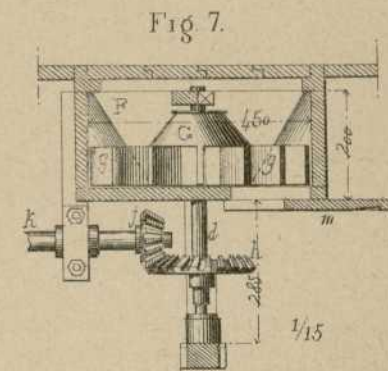
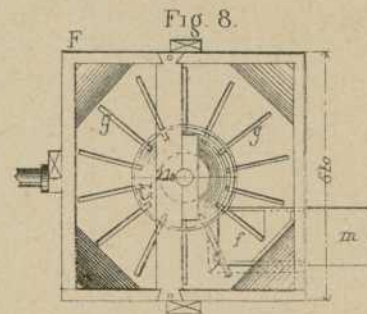
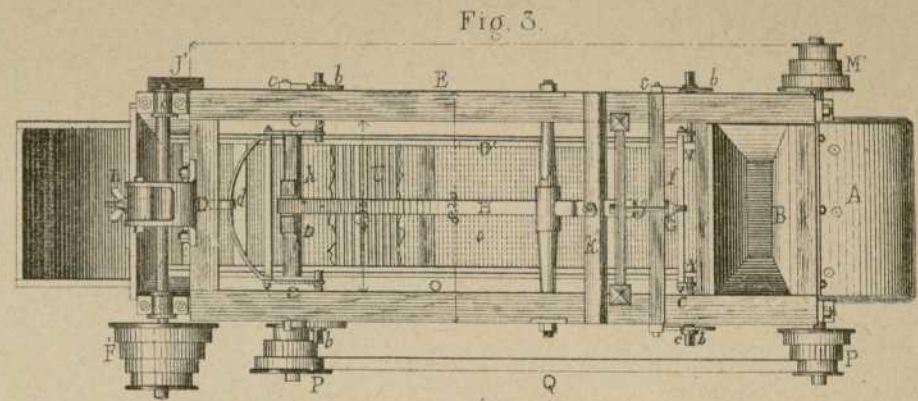
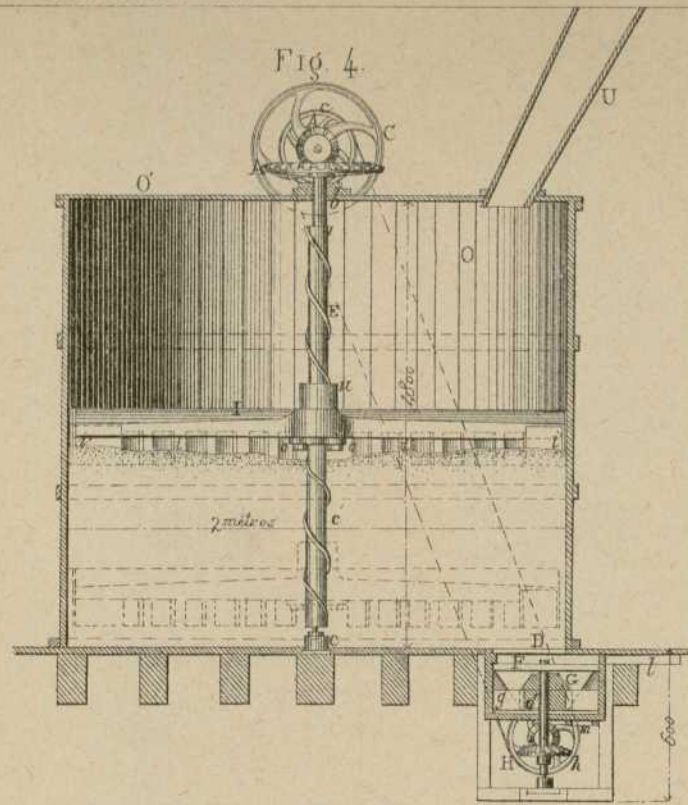


Fig. 11.



Escala de 1/30.

H.E.

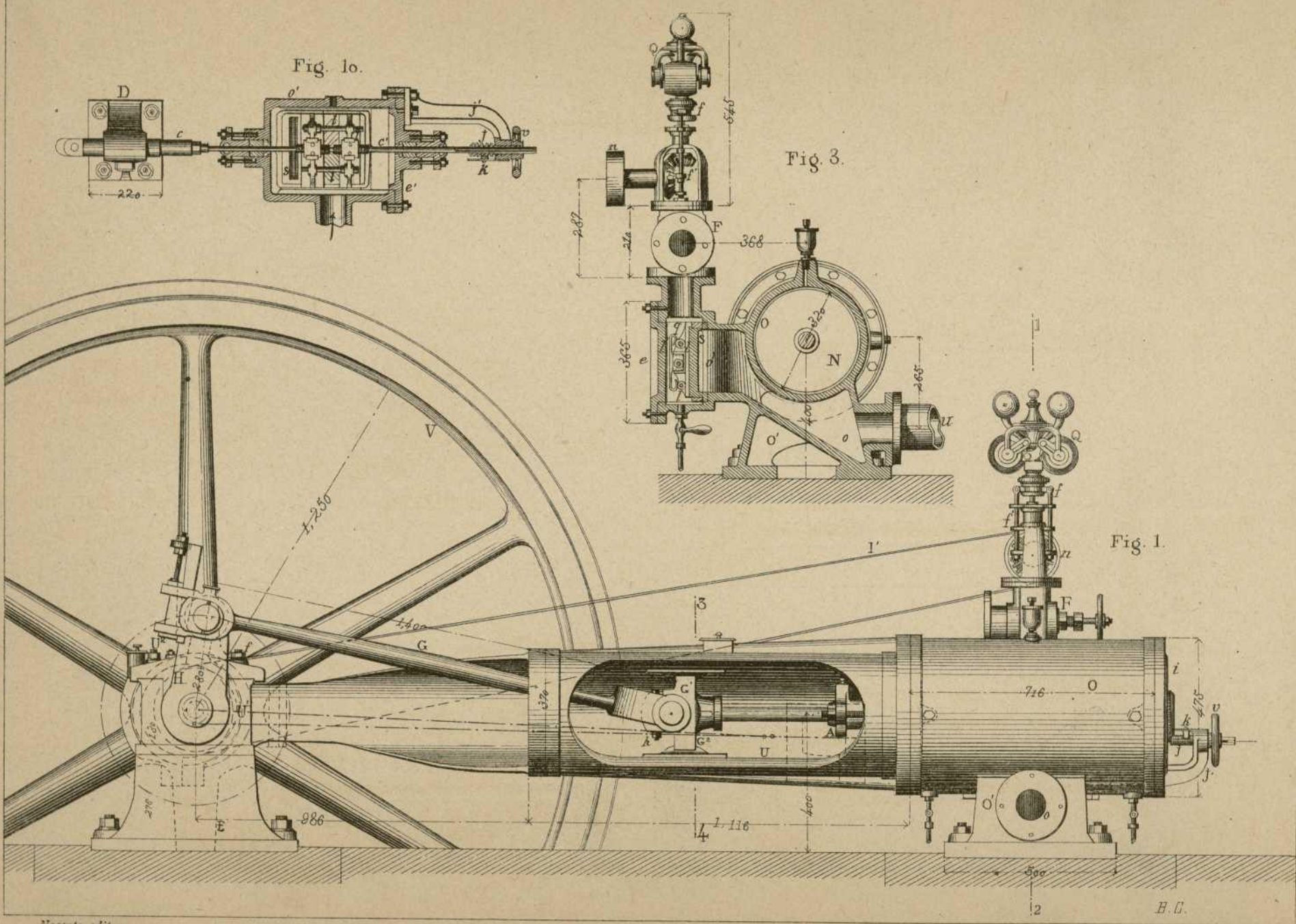


Nuestro editor

Escala de 1/30.

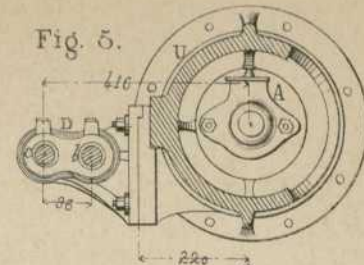
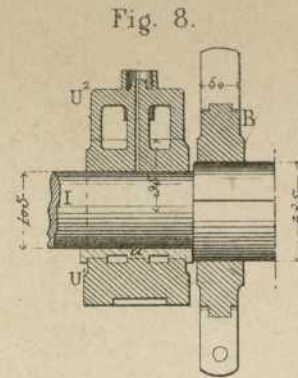
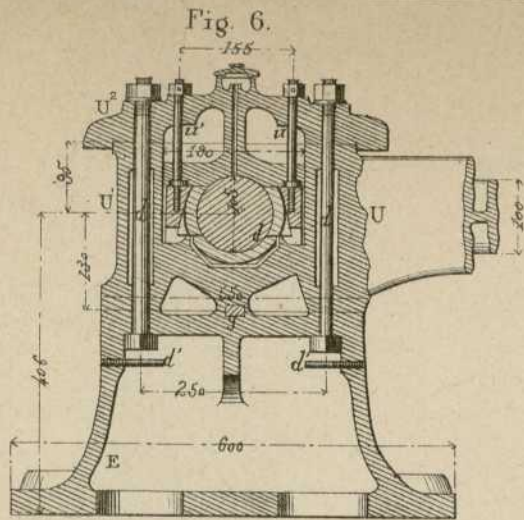
B C

Disco de Gracia 140.

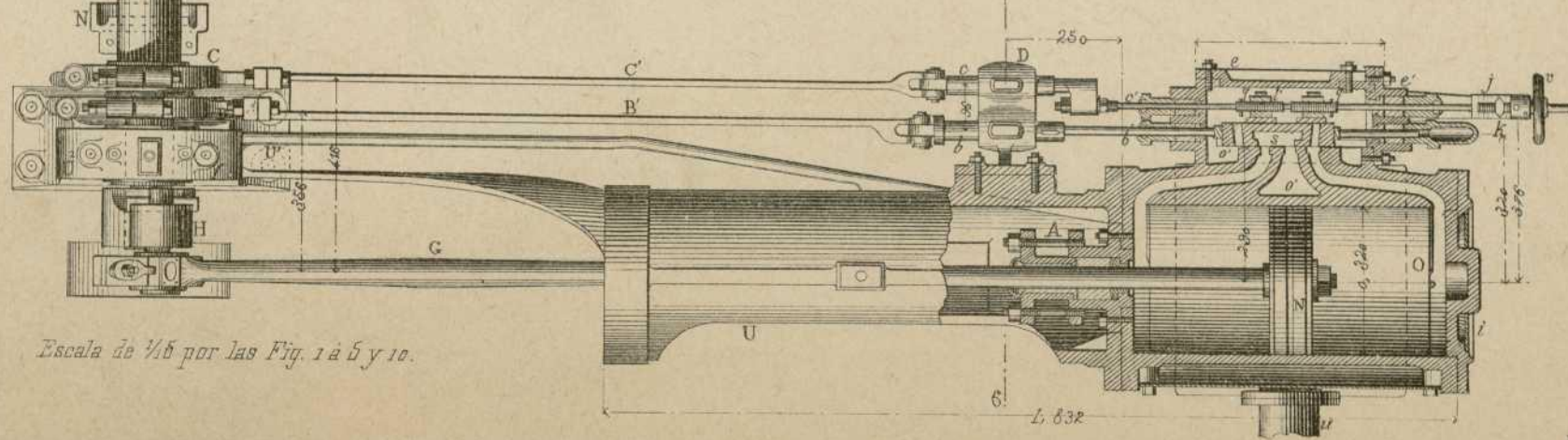
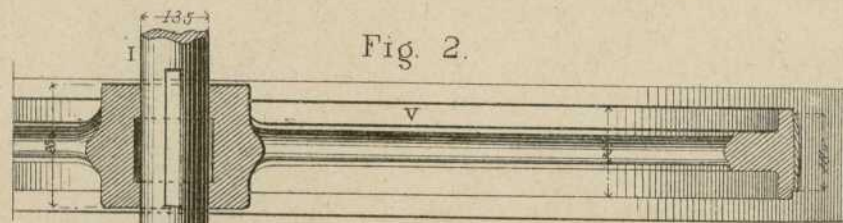
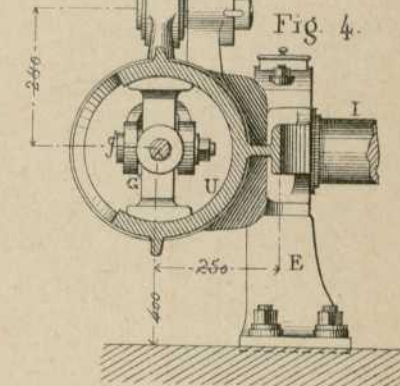
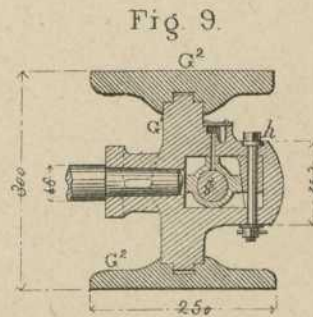
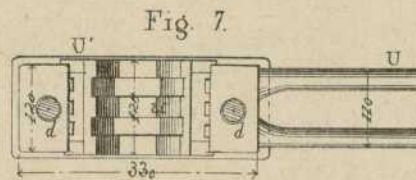


Mascher, editor.

H. G.
Papeles de Construcción



Escala de 1/10



Escala de 1/16 por las Fig. 1 à 5 y 10.

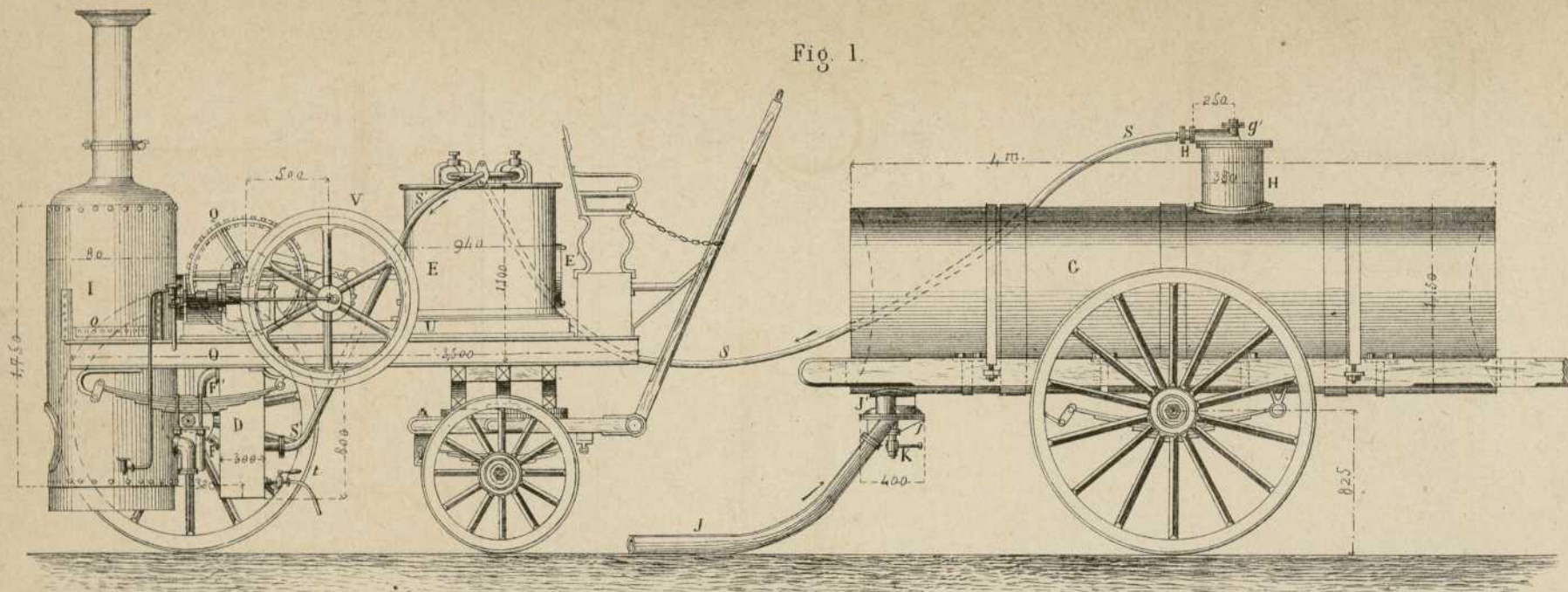


Fig. 1.

Escala de $\frac{1}{40}$

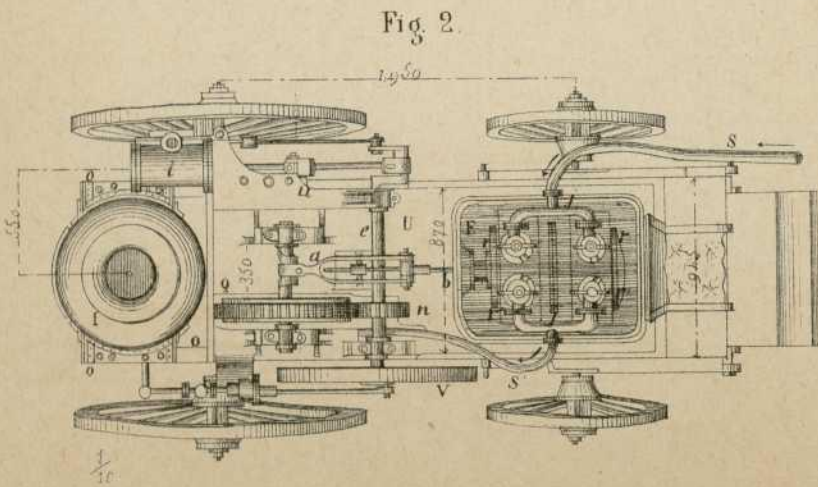


Fig. 2.

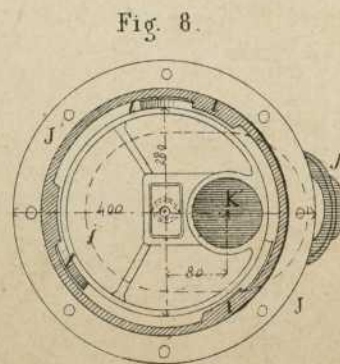


Fig. 8.

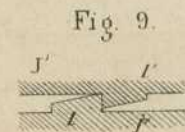


Fig. 9.

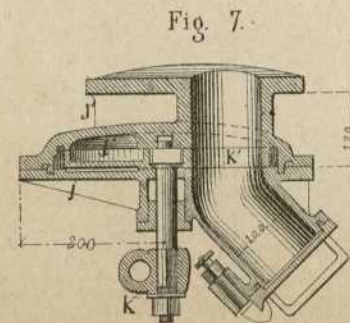


Fig. 7.

Fig. 3.

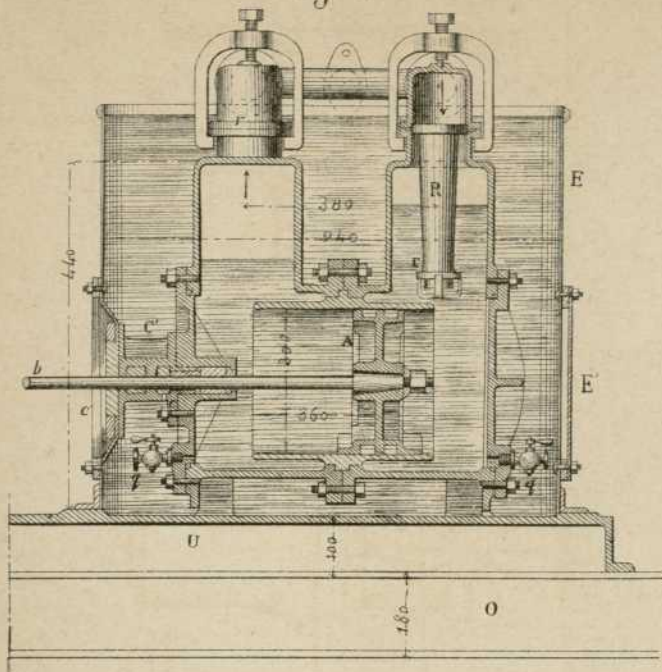


Fig. 5.

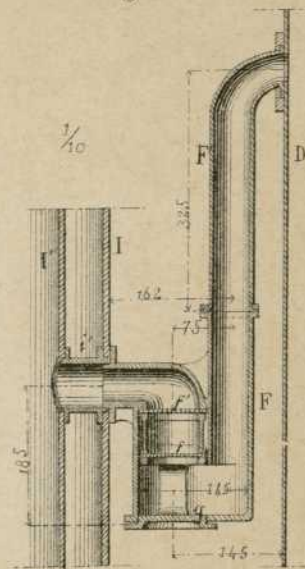


Fig. 12.

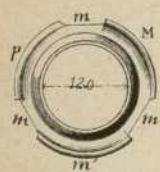


Fig. 10.

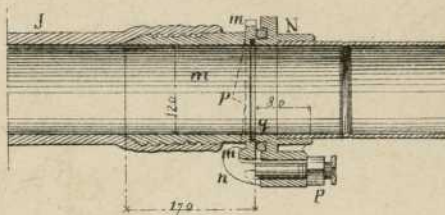


Fig. 11.

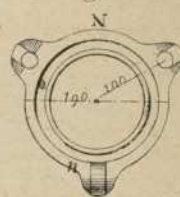


Fig. 6.

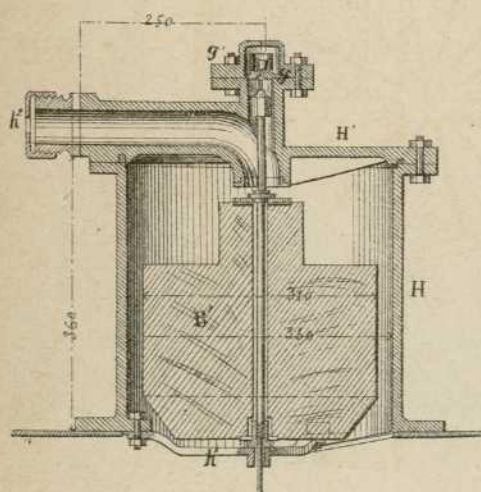
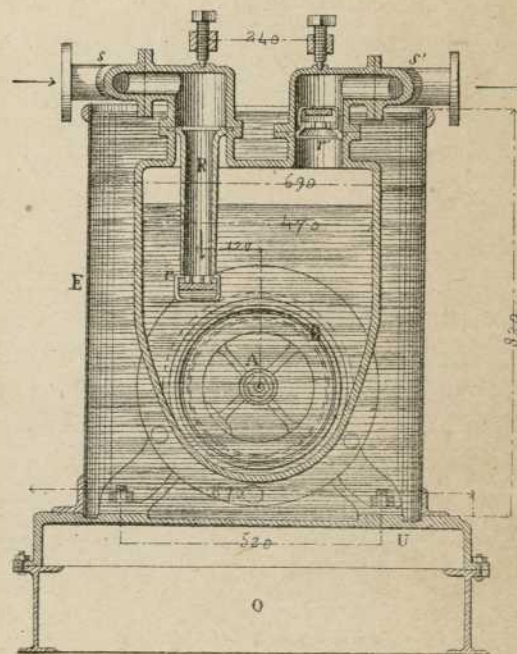


Fig. 4.



Escala de 1/15

B.G.

Fig. 1.

Escala de $\frac{1}{80}$.

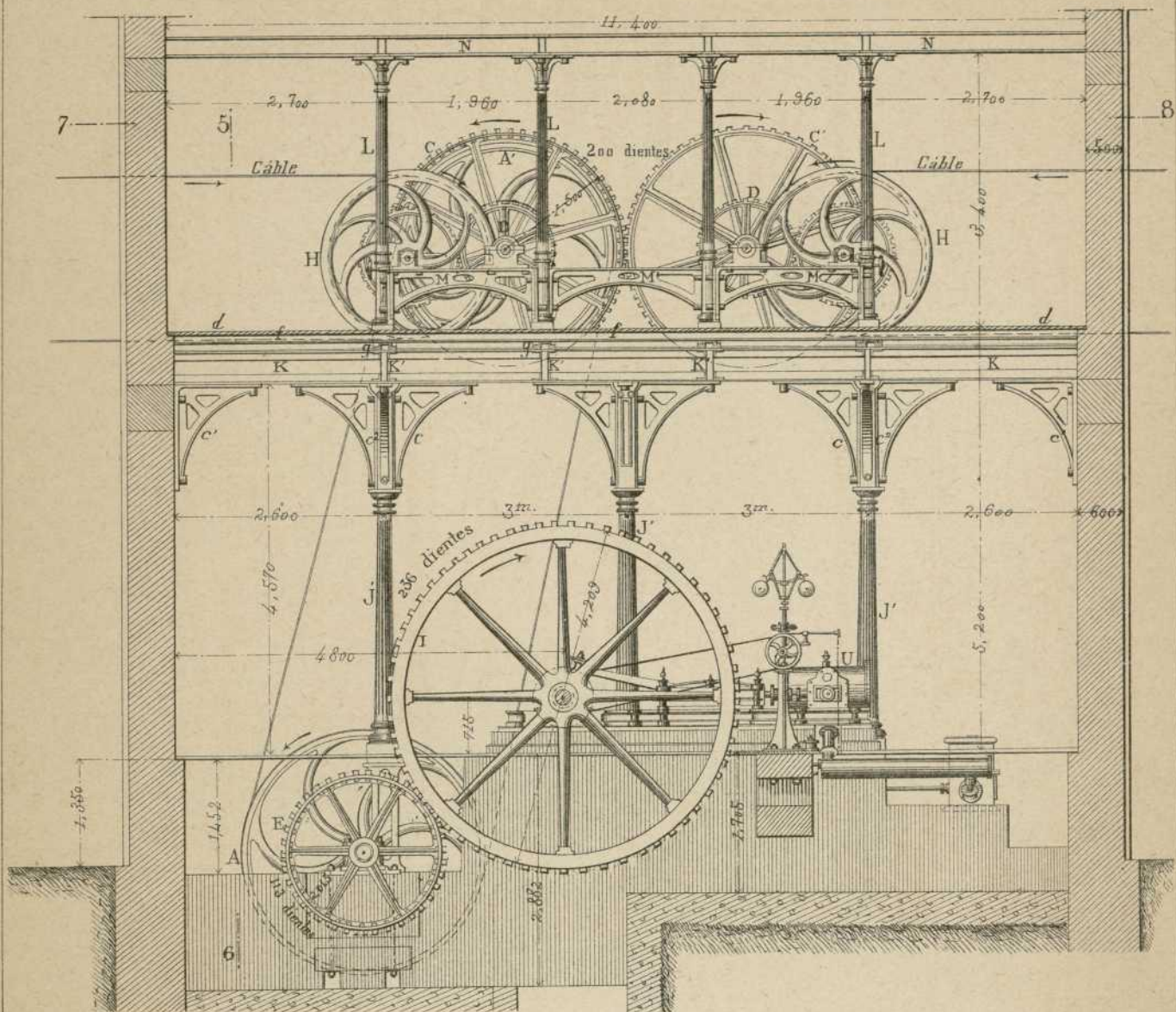


Fig. 4.

Escala de $\frac{1}{1000}$.

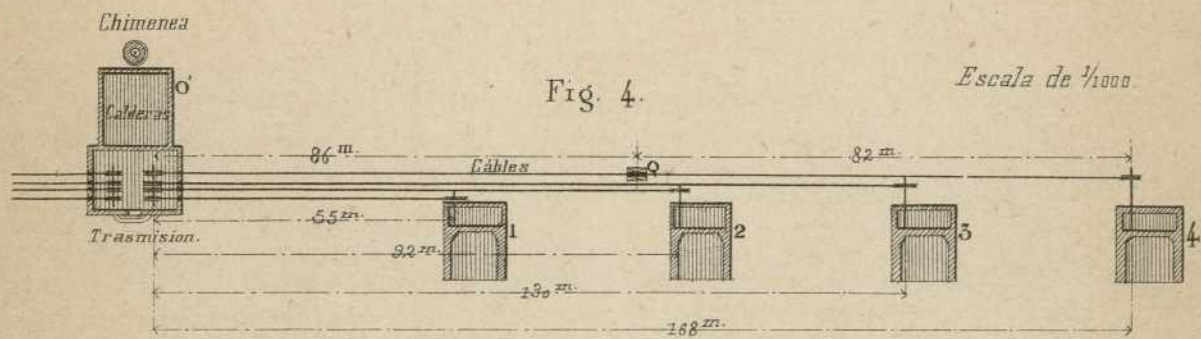


Fig. 2.

Escala de $\frac{1}{80}$

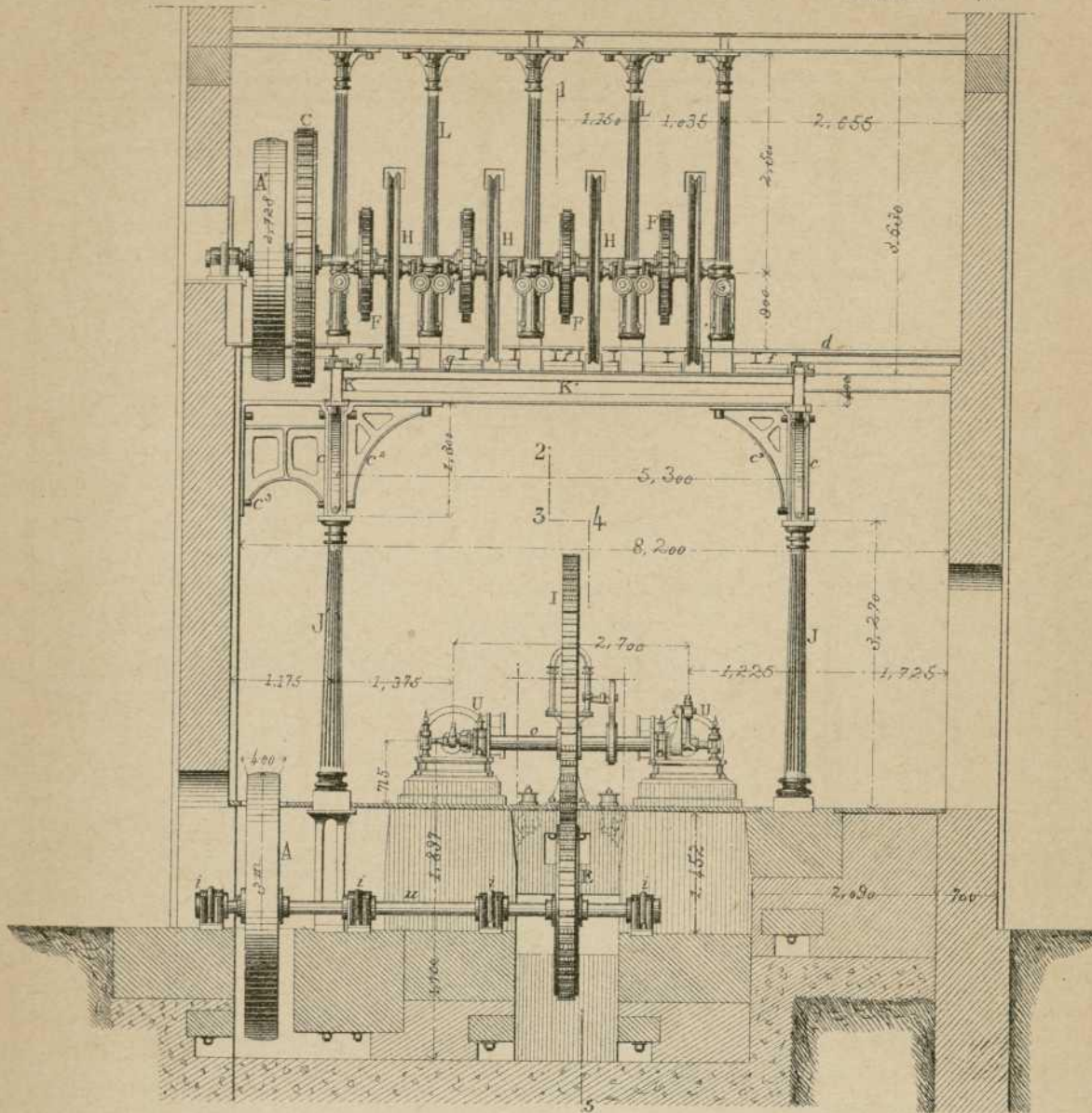
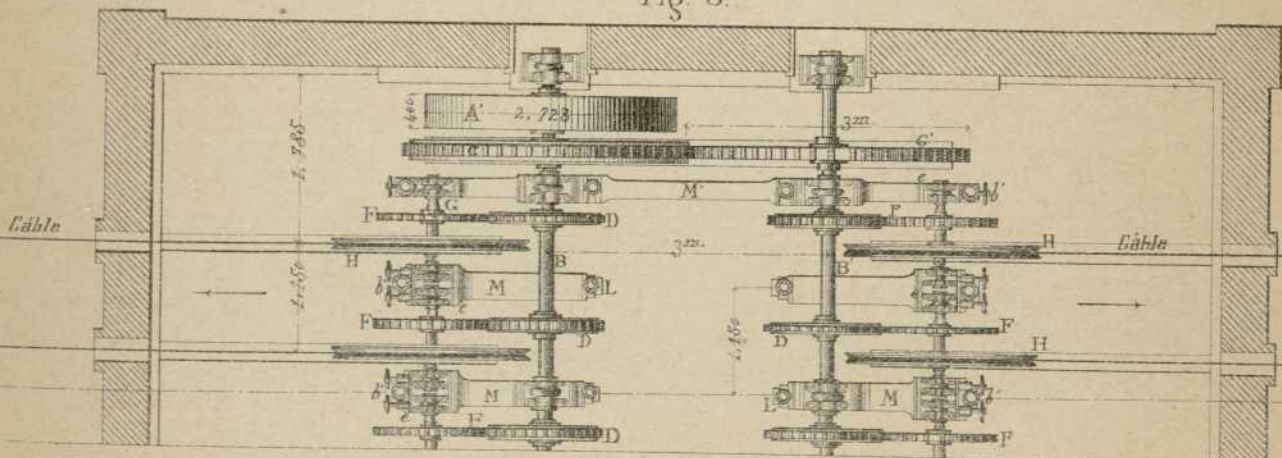


Fig. 3.



Escala de $\frac{1}{1000}$.

H. E.

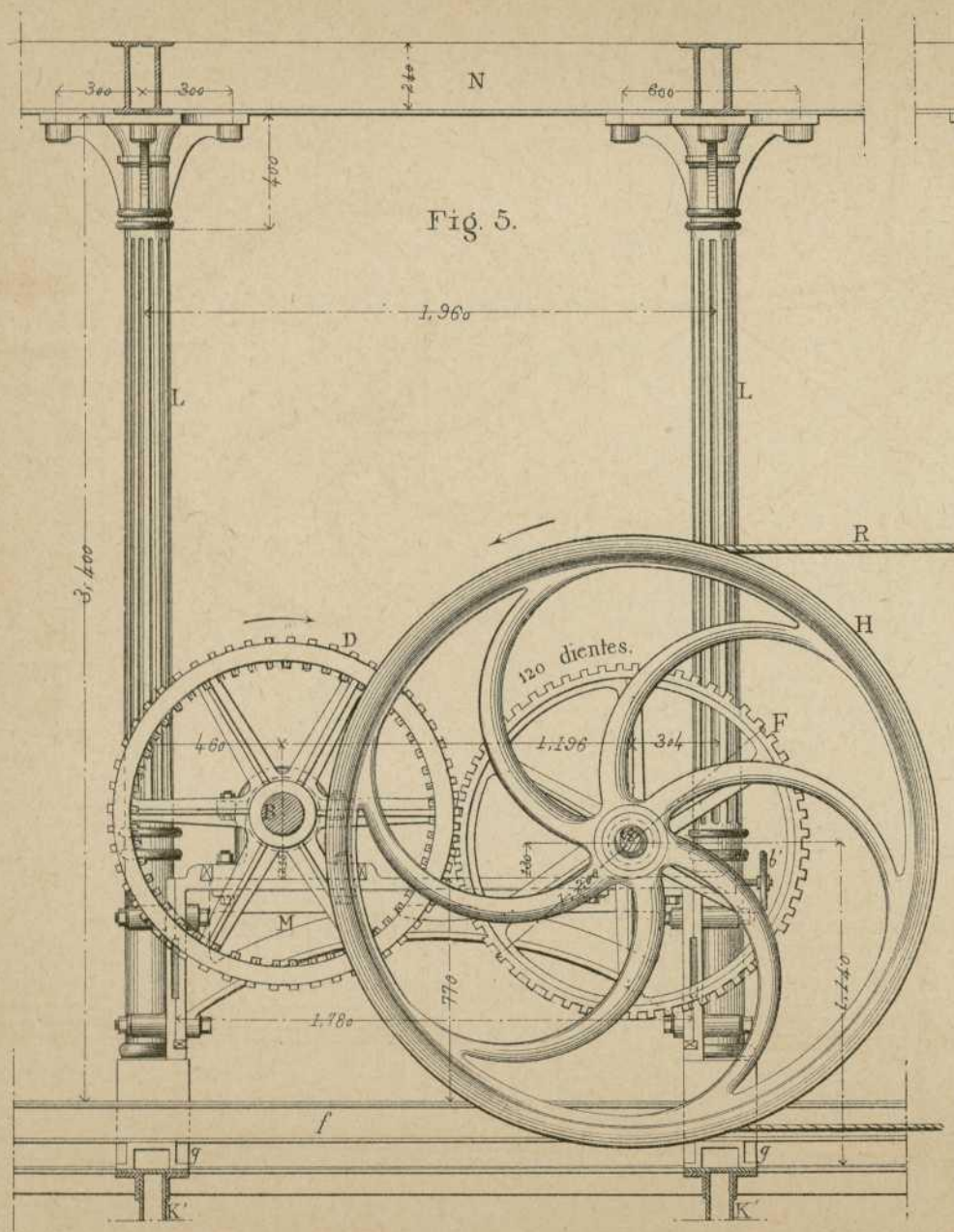


Fig. 5.

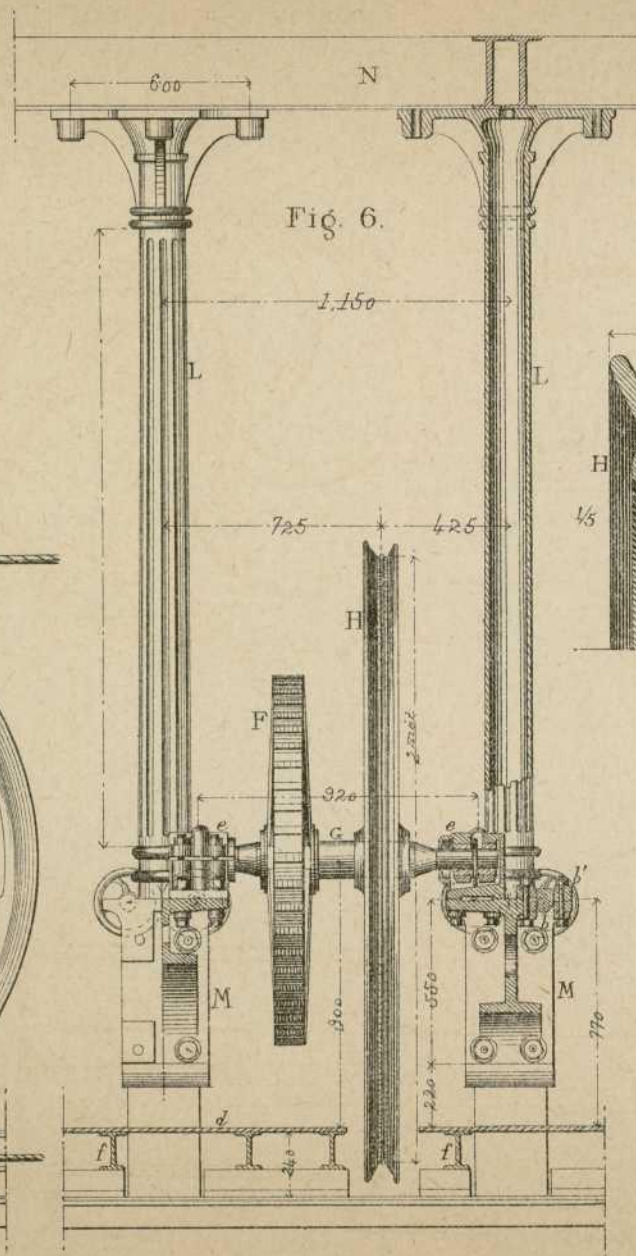


Fig. 6.

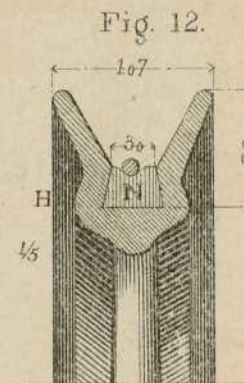


Fig. 12.

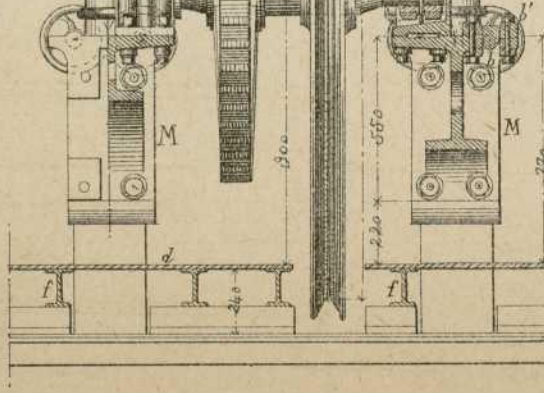


Fig. 13.

Escala de $\frac{1}{25}$ por las Fig. 5 á 11.

F. C.

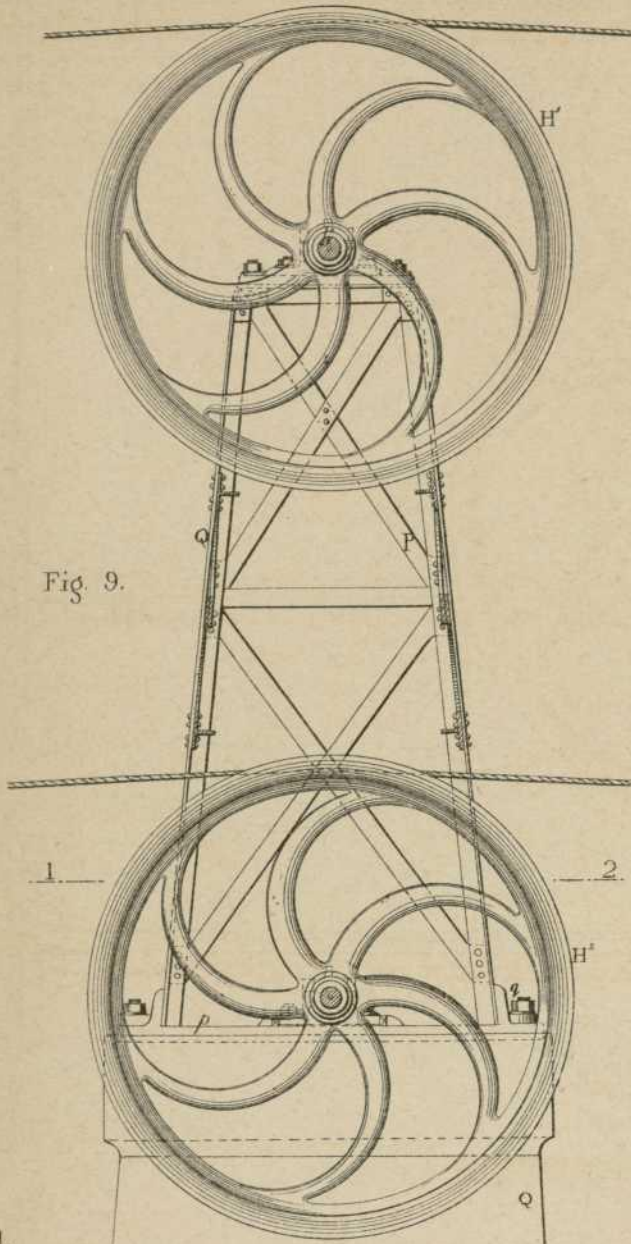
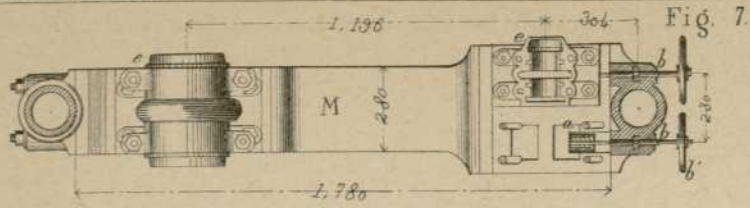


Fig. 9.

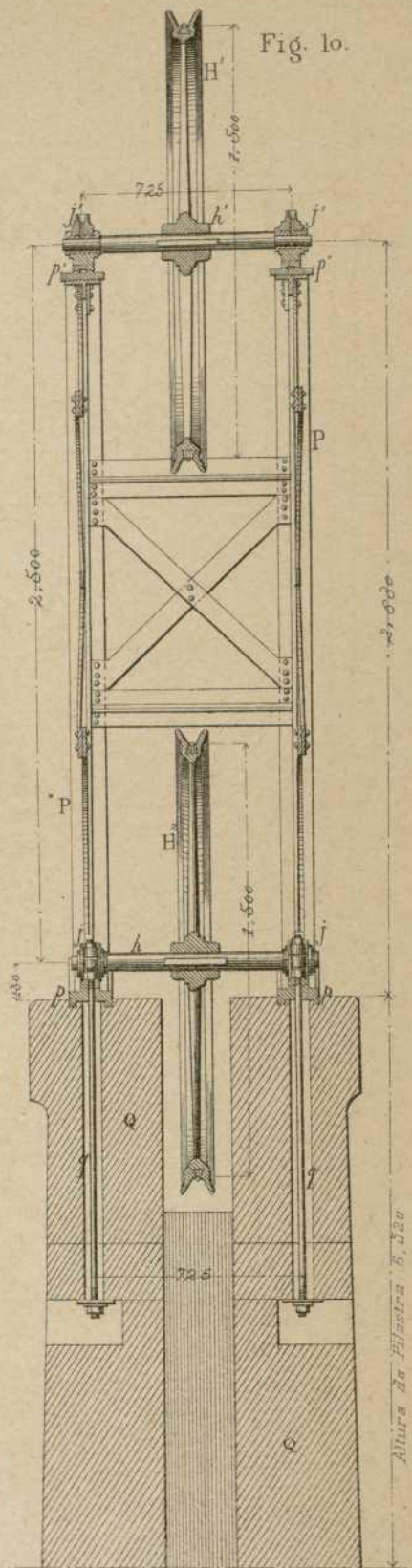


Fig. 10.

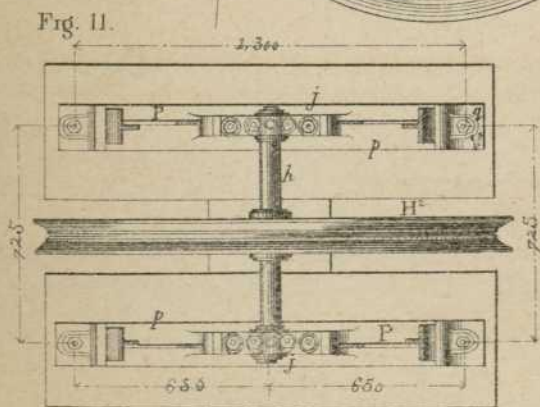


Fig. 11.

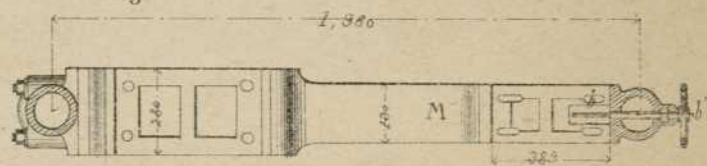
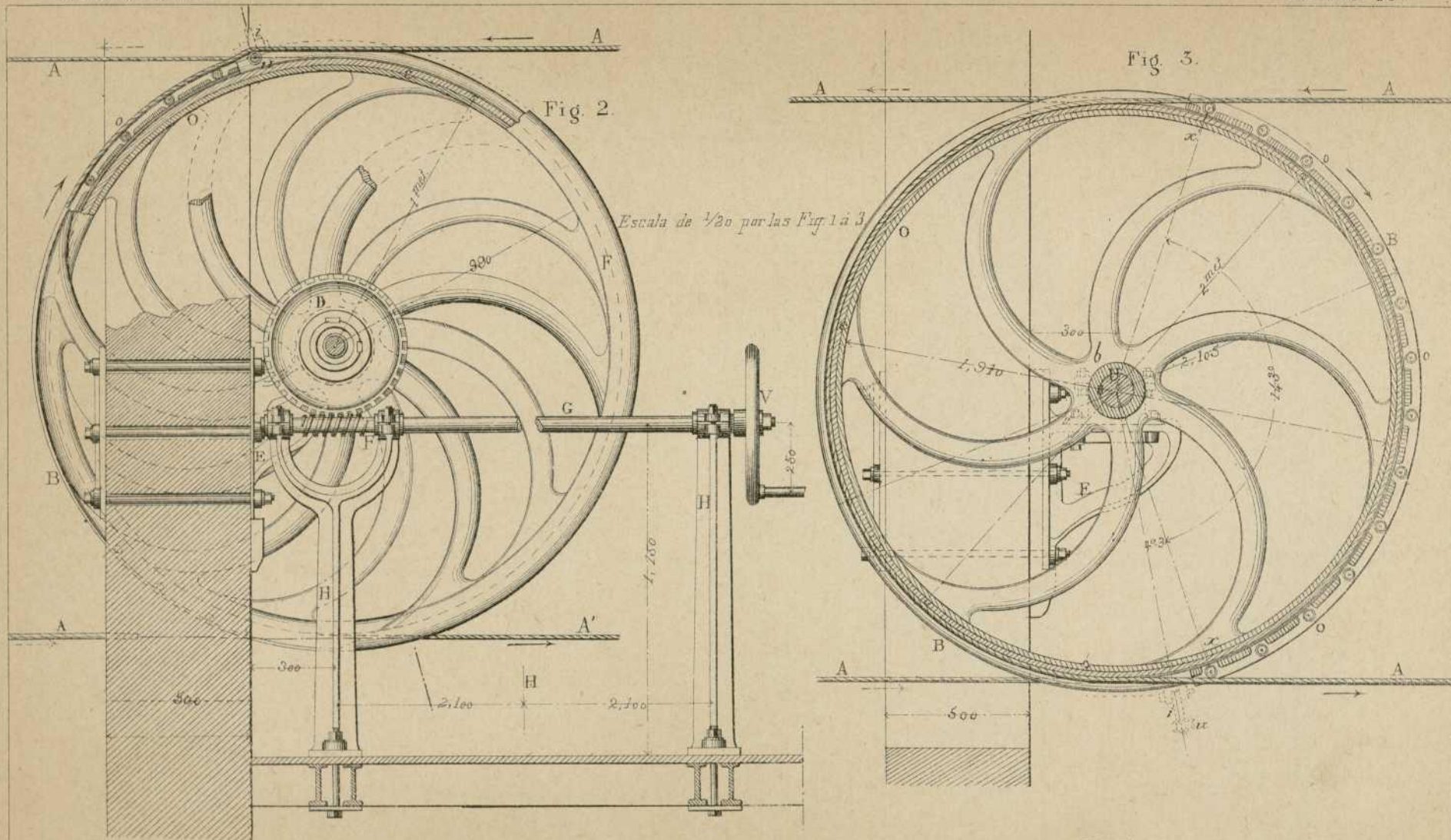
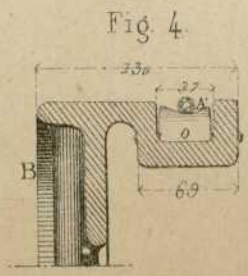


Fig. 8.



Escala de $\frac{1}{6}$ por las Fig. 4. à 7.



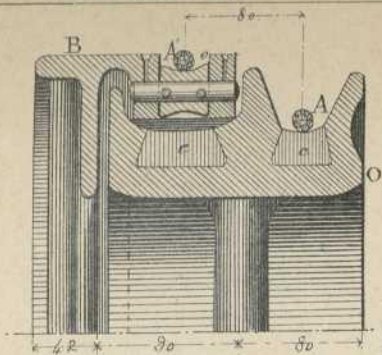


Fig. 5.

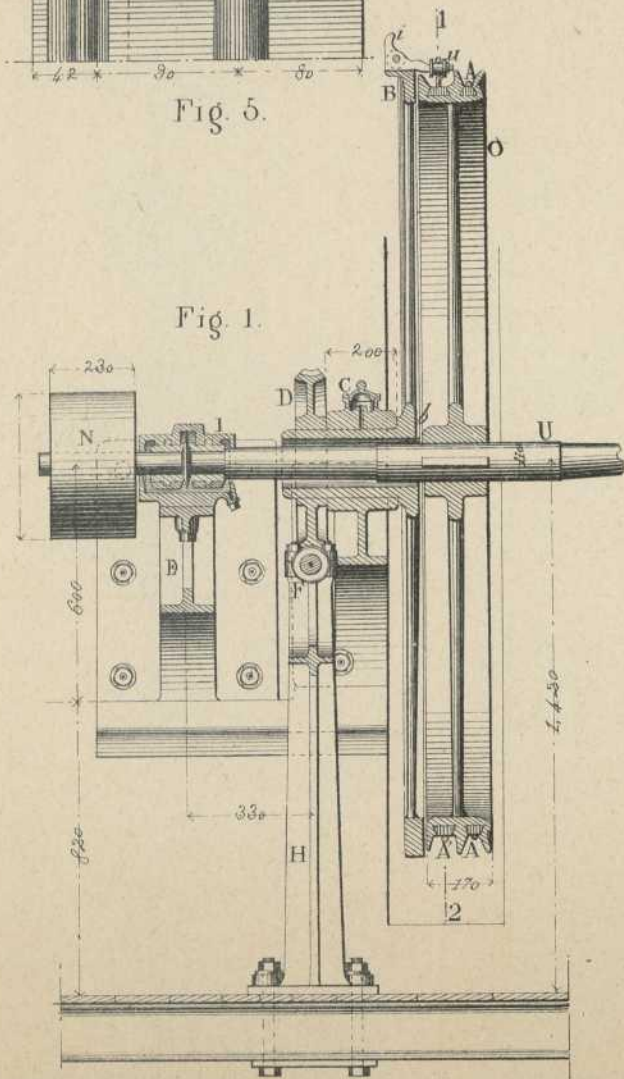


Fig. 1.

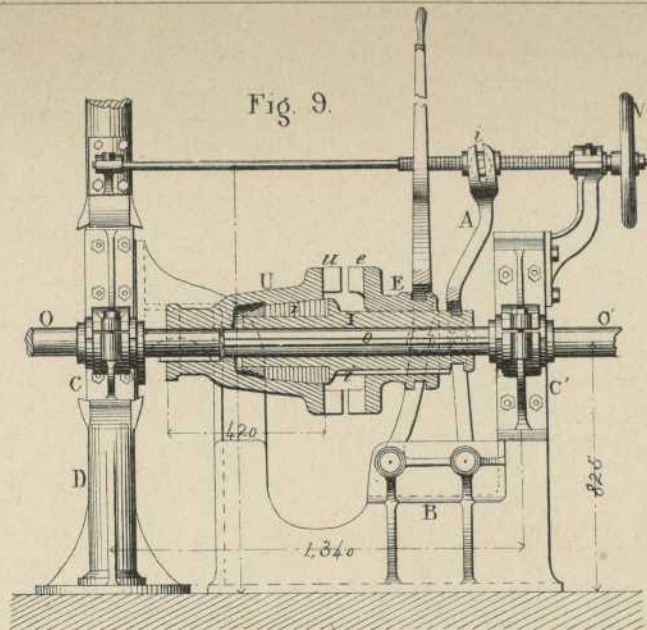


Fig. 9.

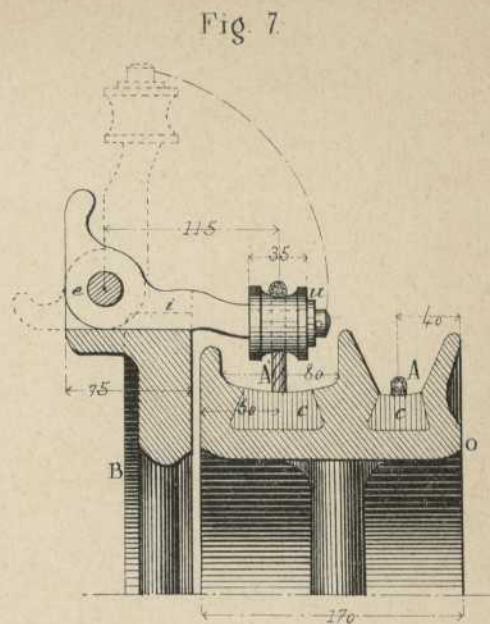


Fig. 7.

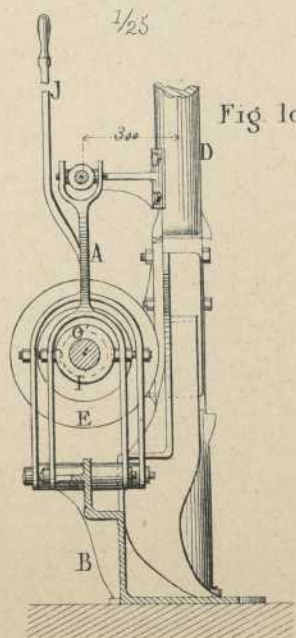


Fig. 10.

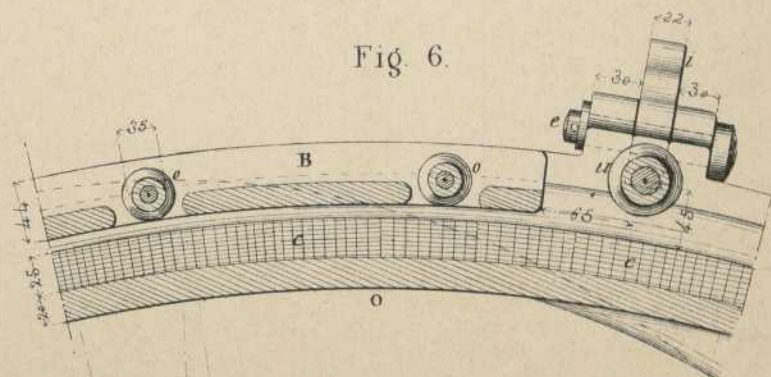
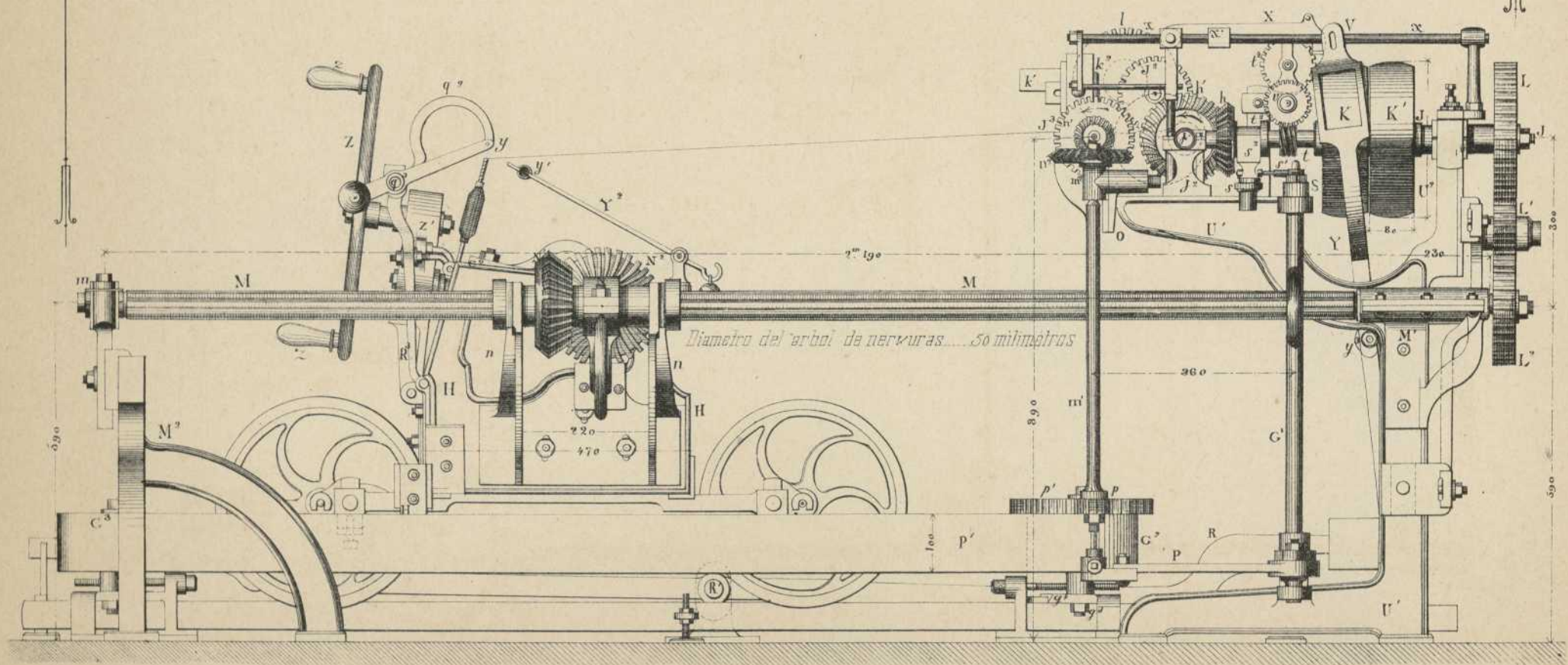


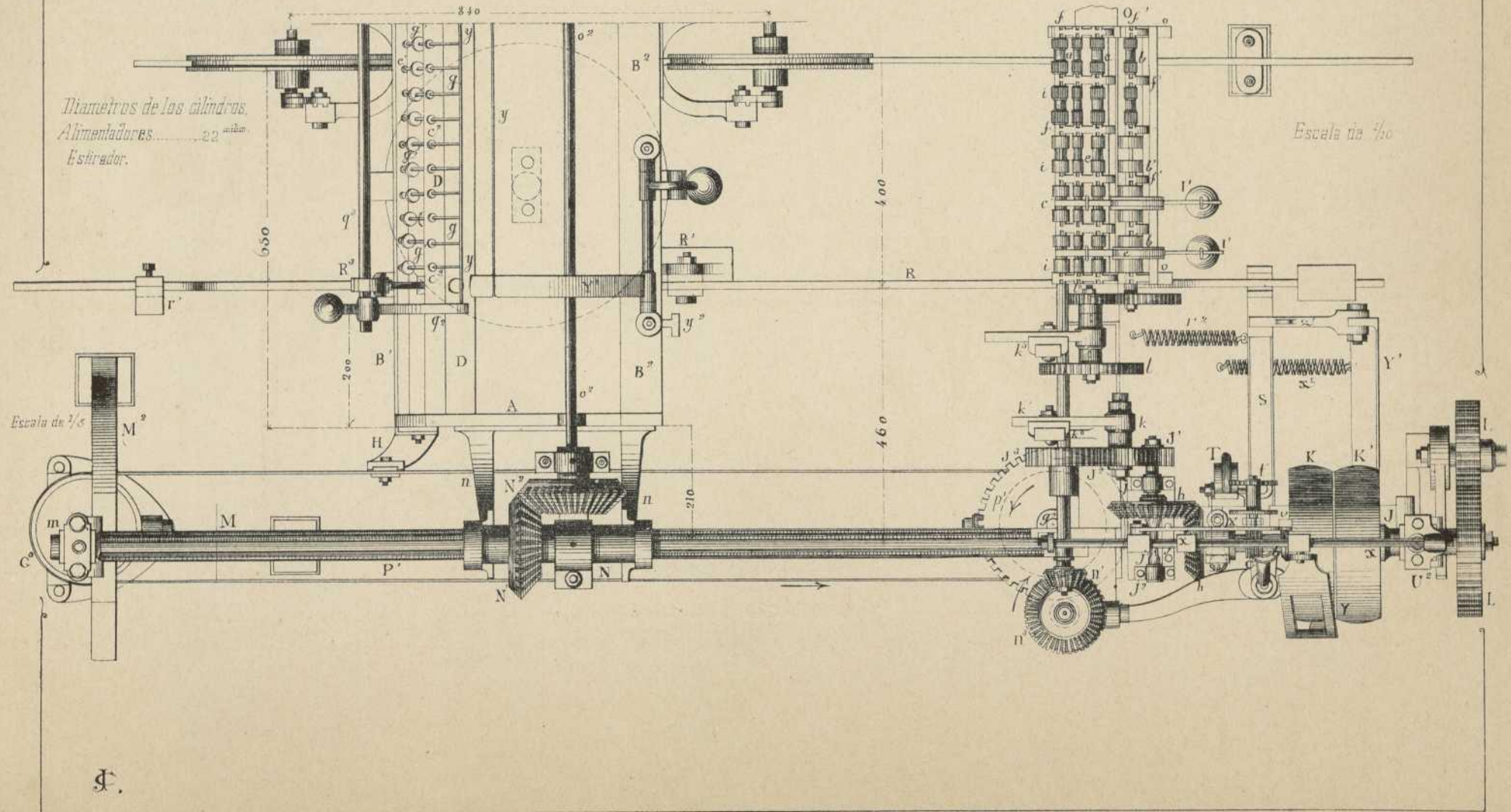
Fig. 6.

Fig. 1.



g.

Fig. 2.



*Diametros de los cilindros.
Alimentadores..... 22 mil.
Estrador.*

Escala de 1/10

Escala de 1/5

F.

Fig. 4.

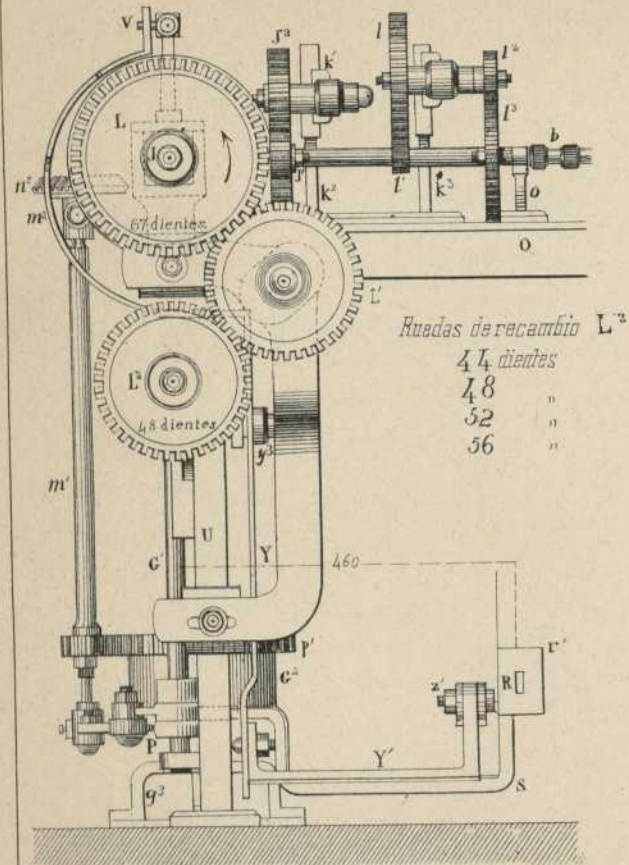


Fig. 12.

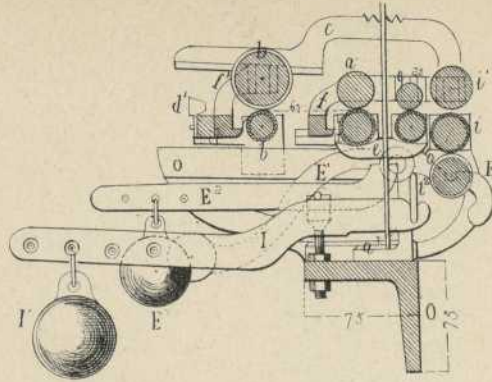
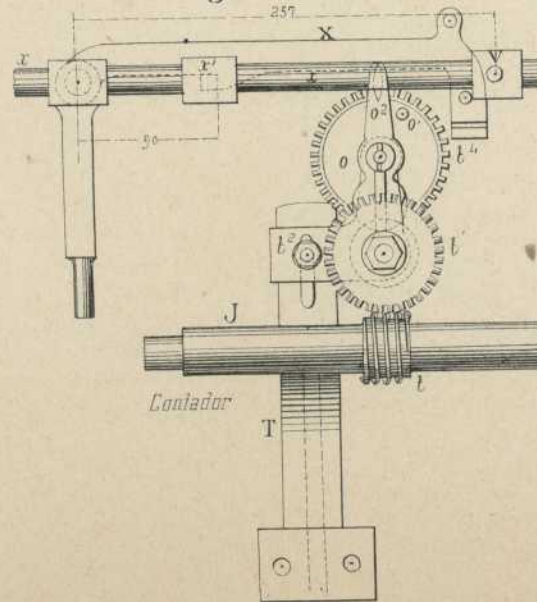


Fig. 11.



Escala de 1/5.

Fig. 3.

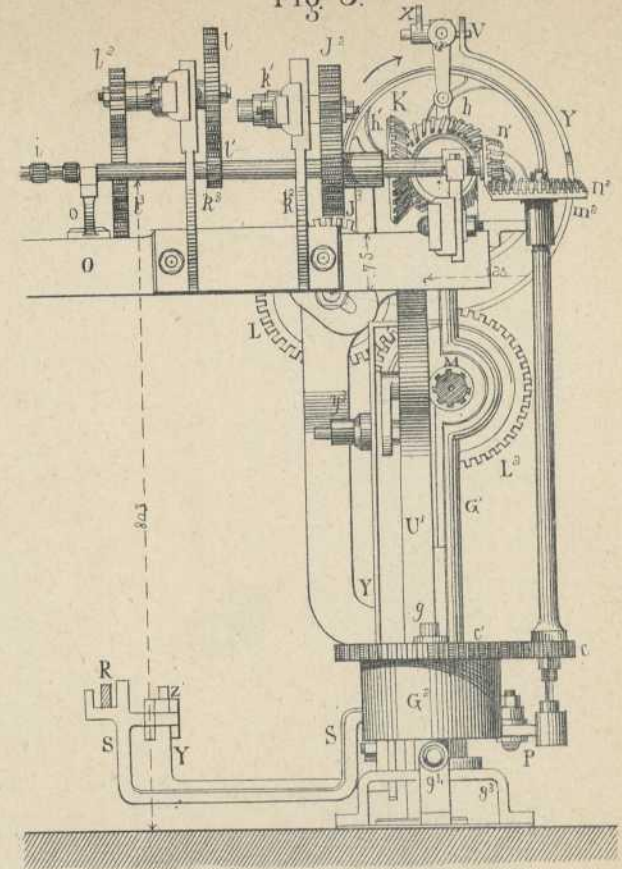
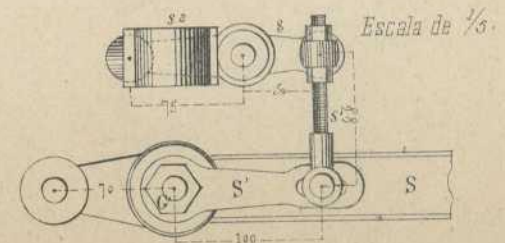
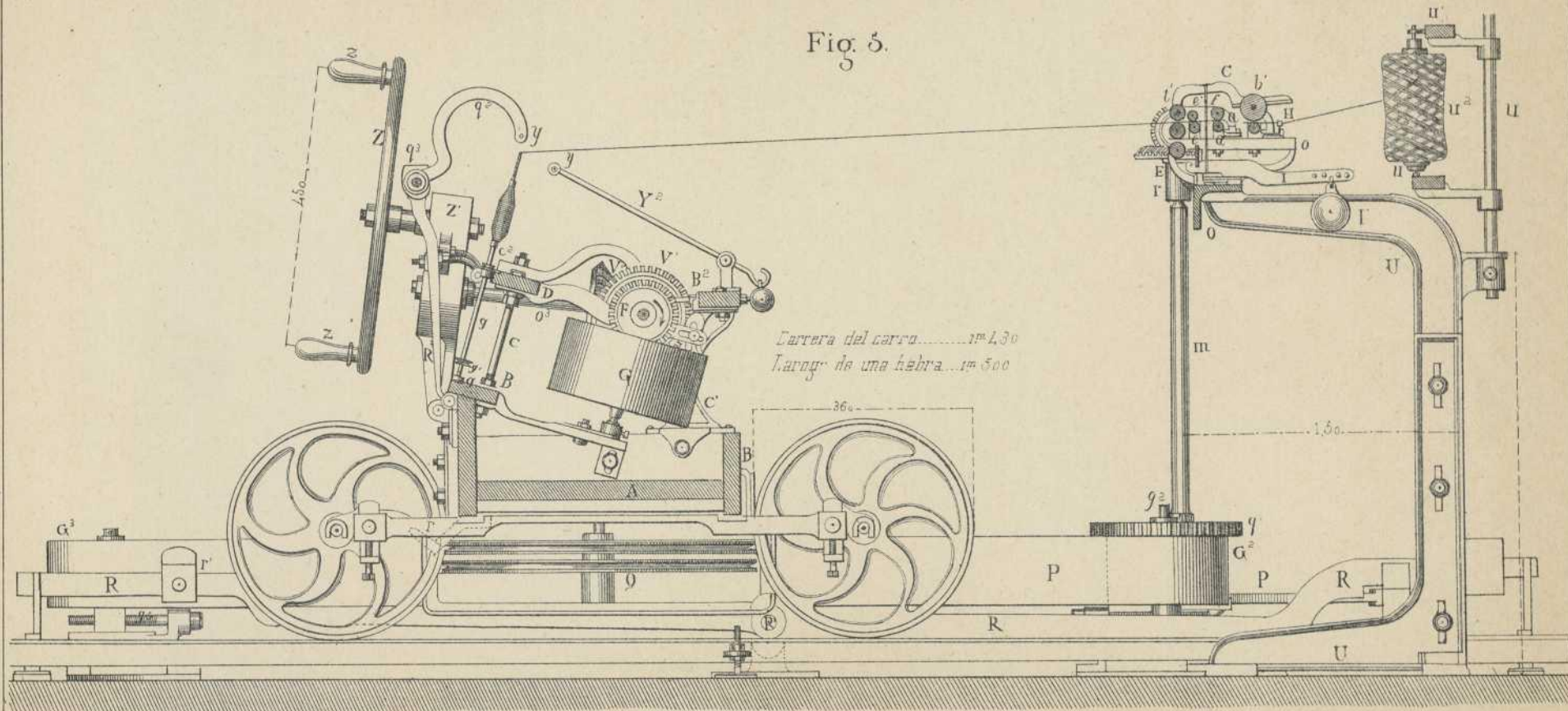


Fig. 13.



A.R.

Fig. 5.



Carrera del carro... 1^m 4,30
Largo de una hebra... 1^m 500

J. G.

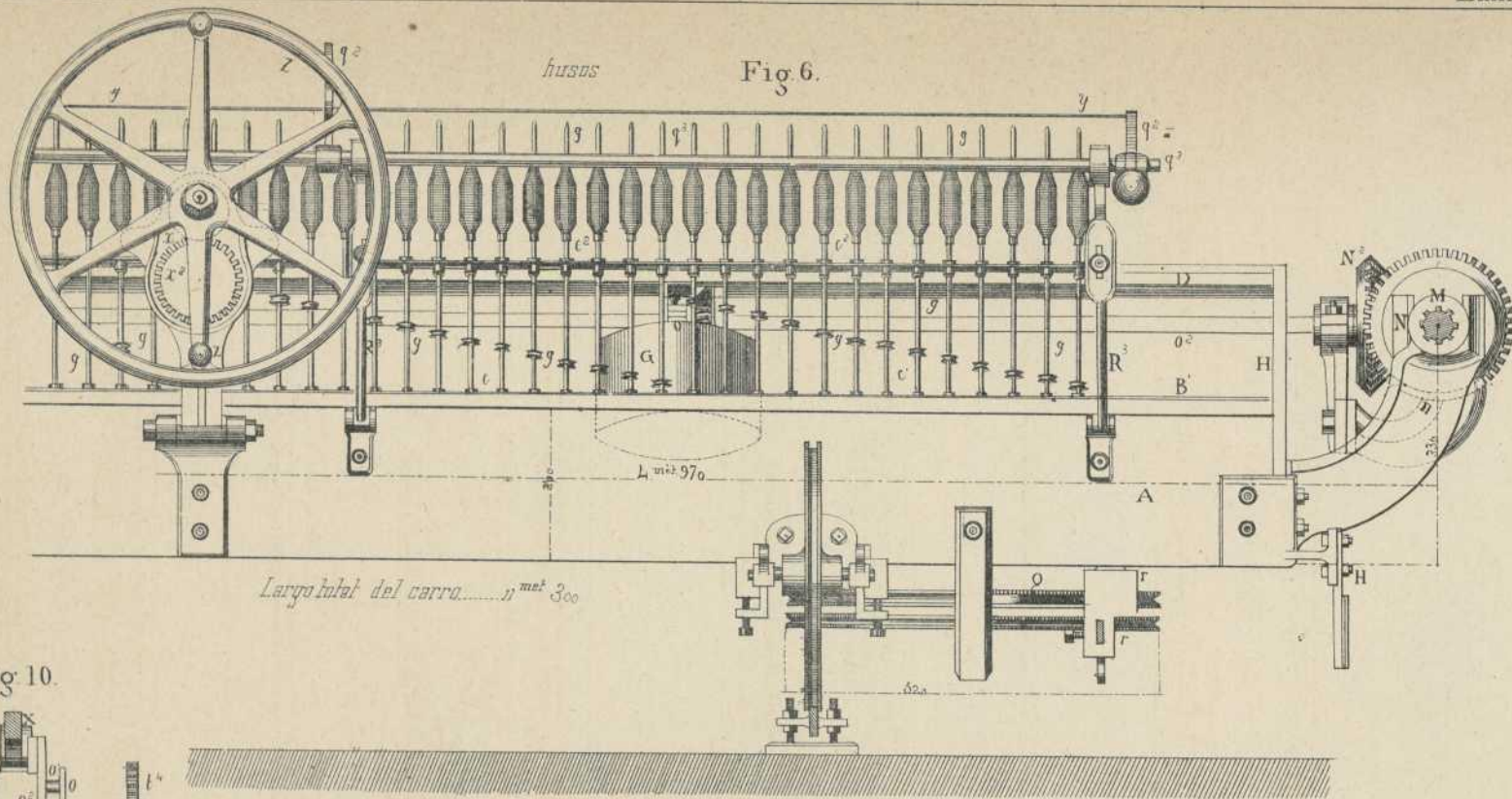
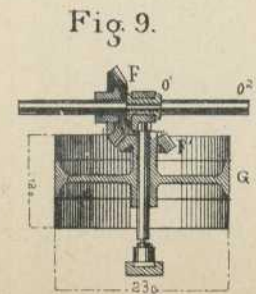
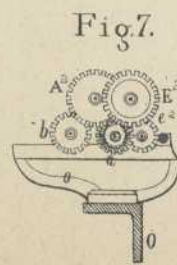
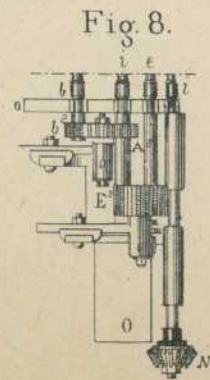
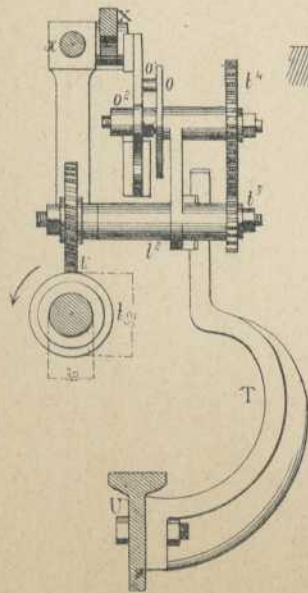


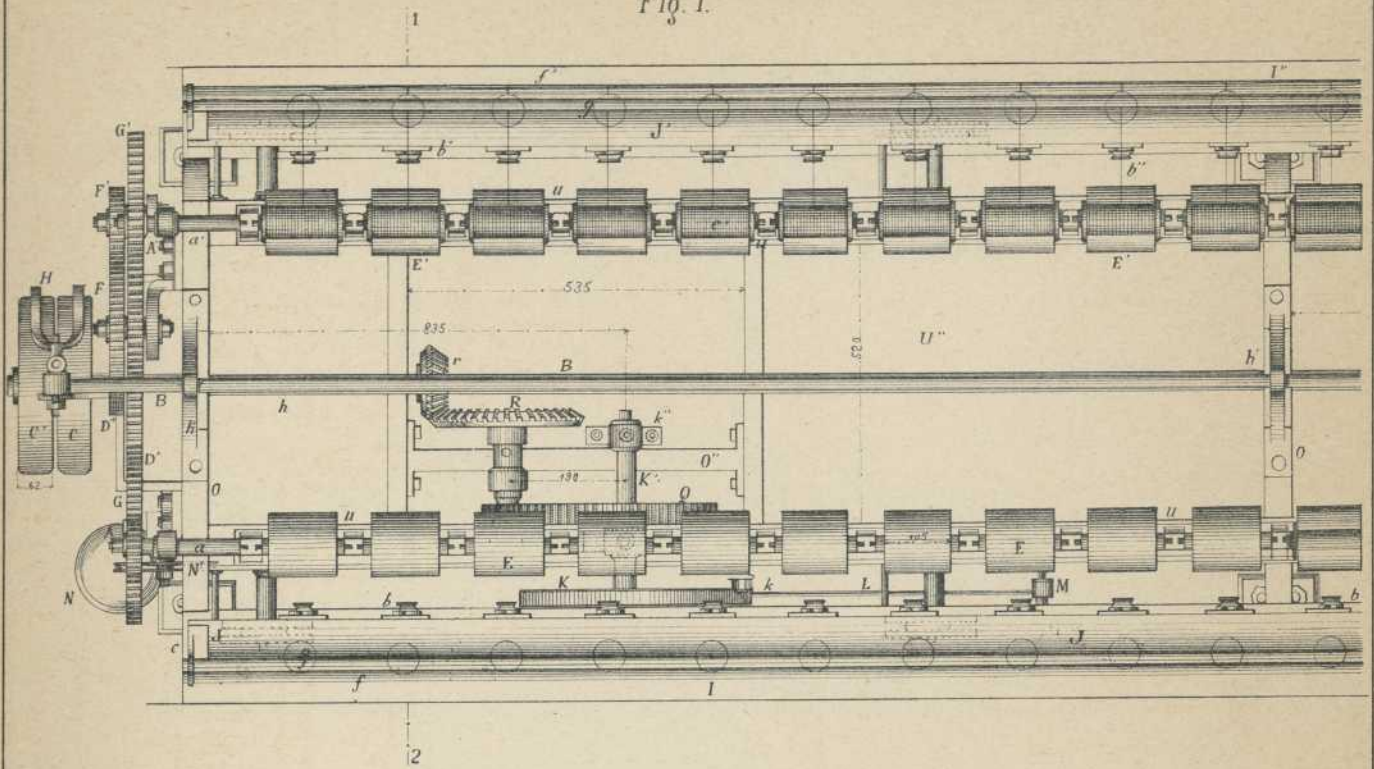
Fig. 10.



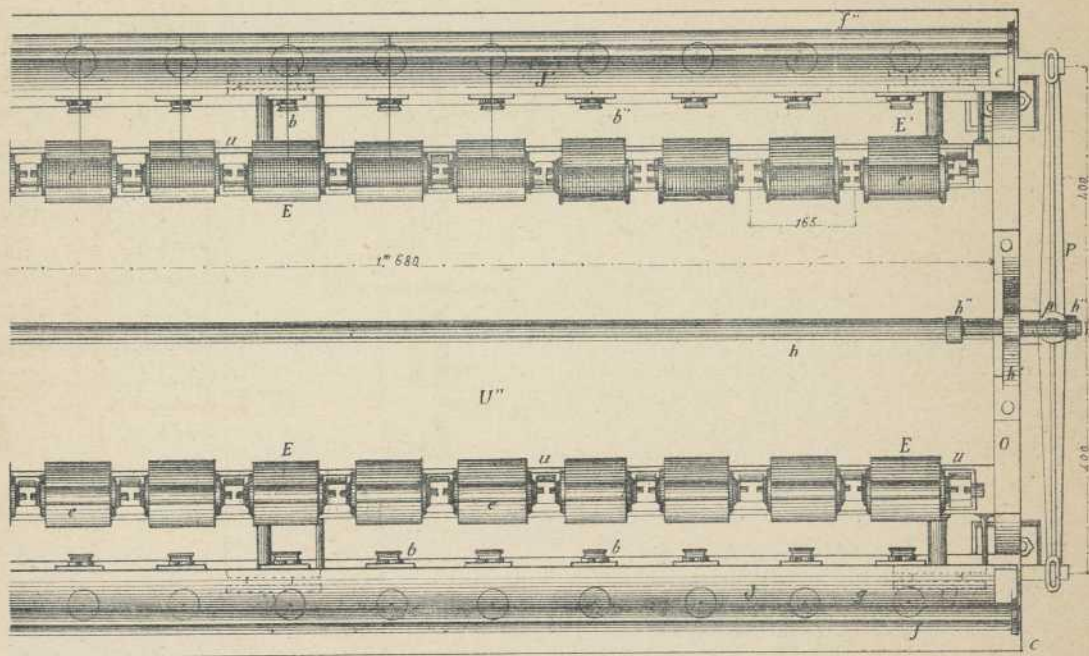
Escala de 1/10 para las Fig 5 à 8.

J. G.

Fig. 1.



Continuacion de la Fig. anterior.



Cont. 10.5

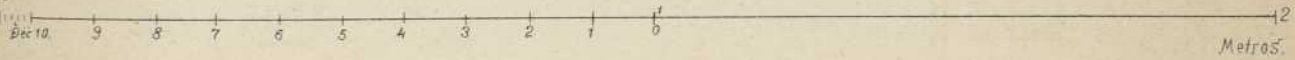


Fig. 2.

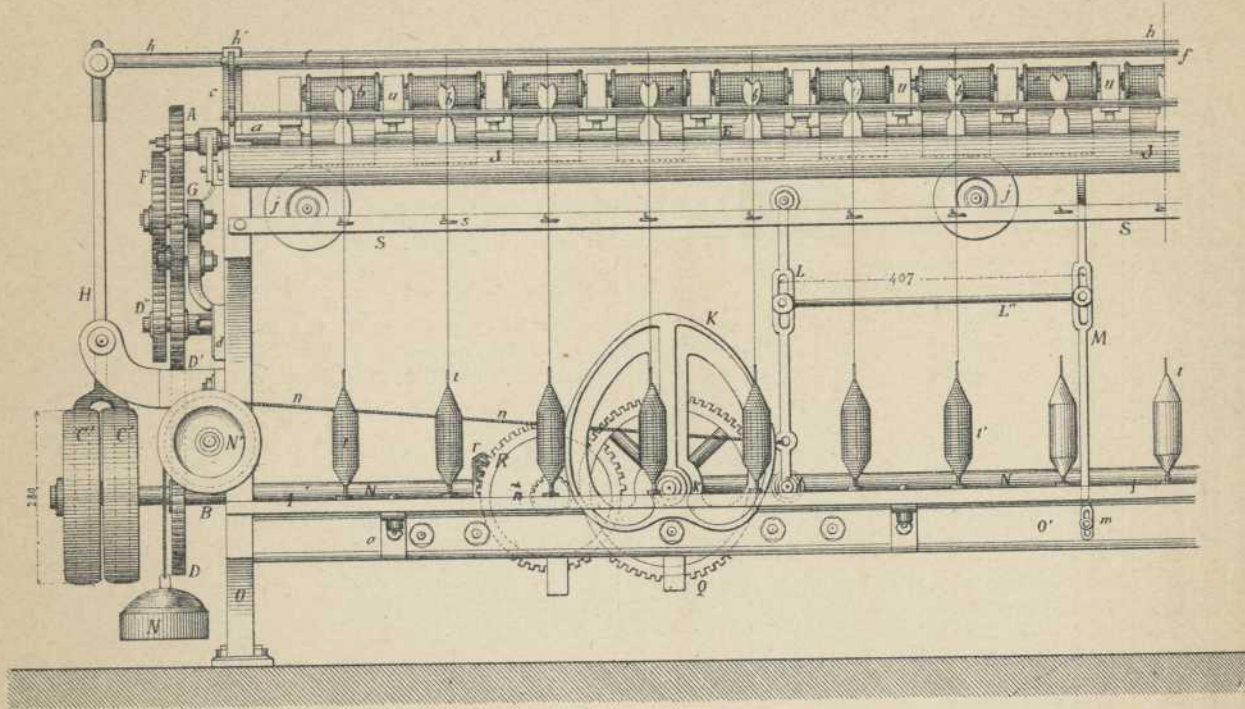


Fig. 3.

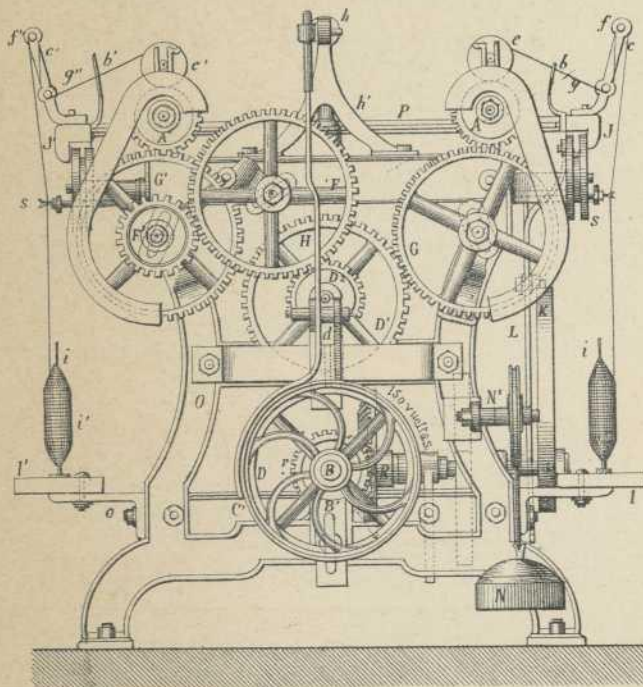


Fig. 4.

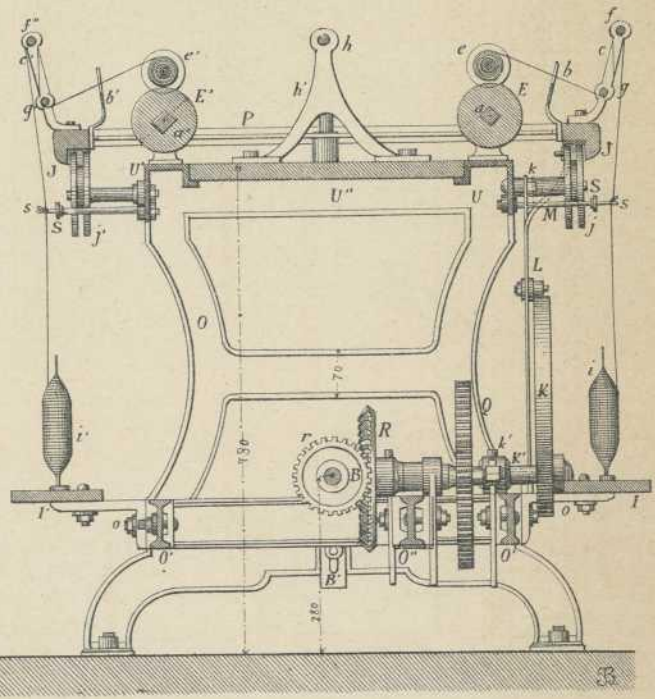


Fig. 1.

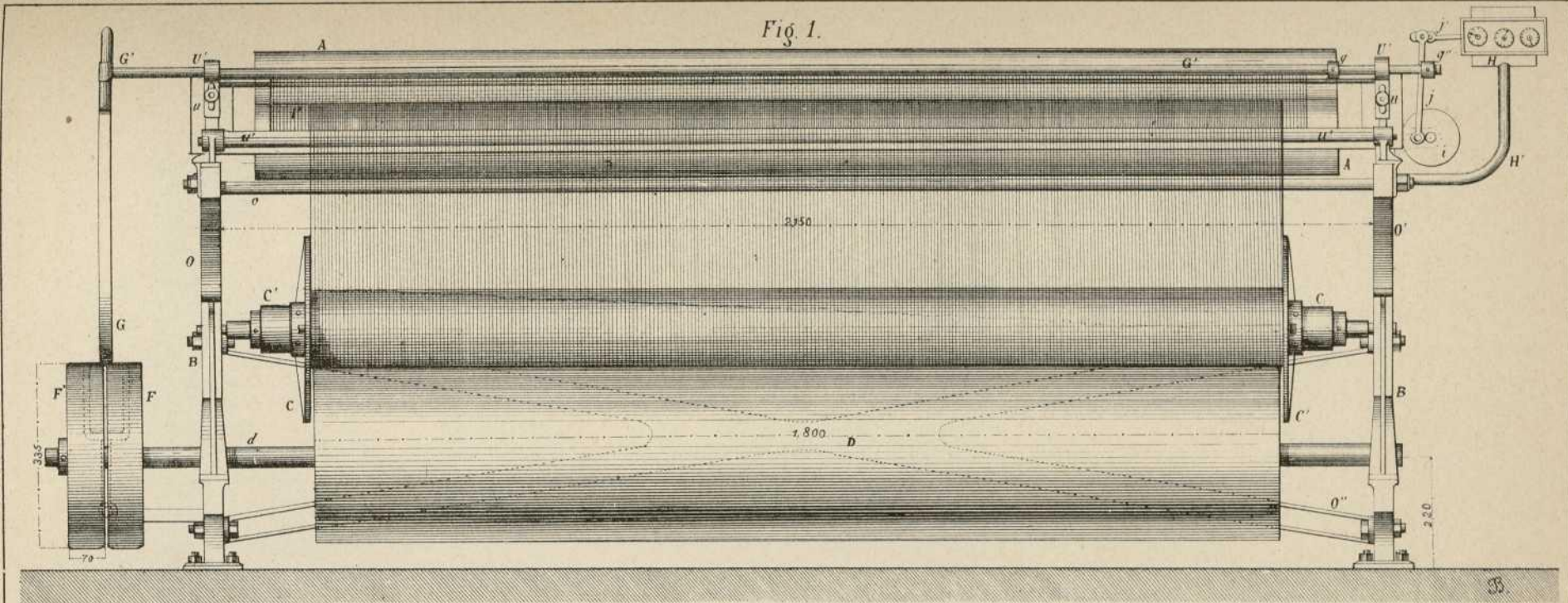


Fig. 2.

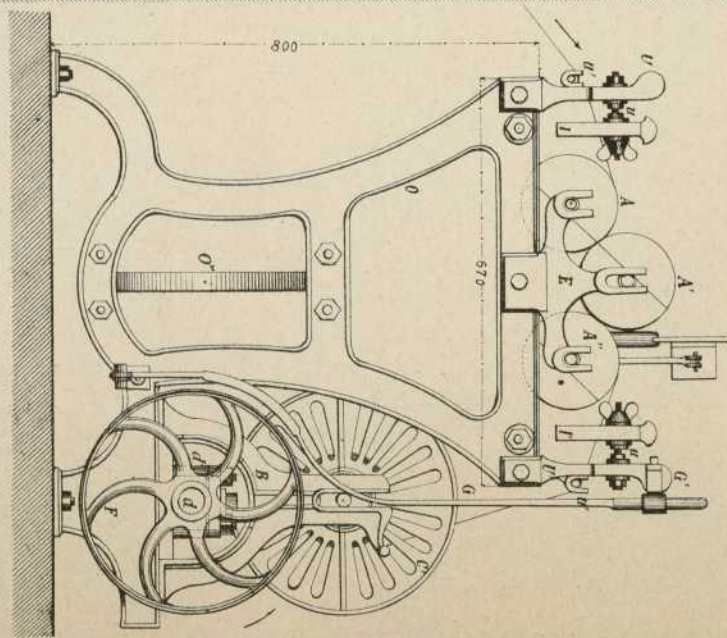


Fig. 4.

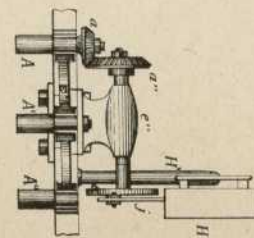


Fig 3.

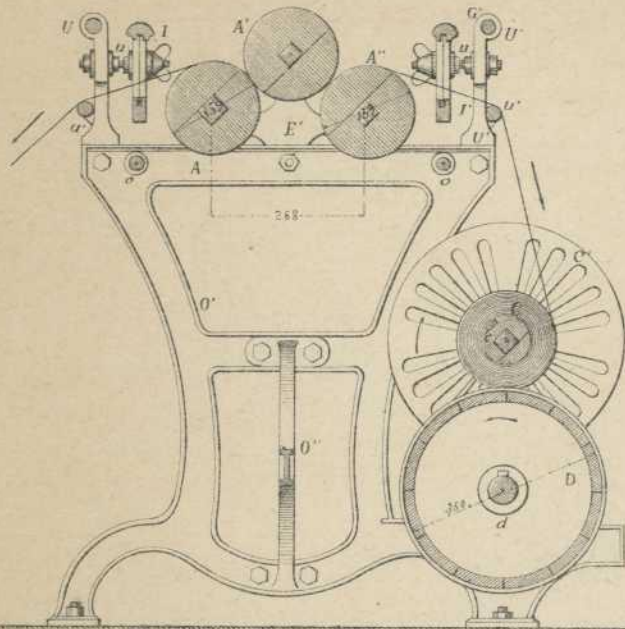


Fig 6.

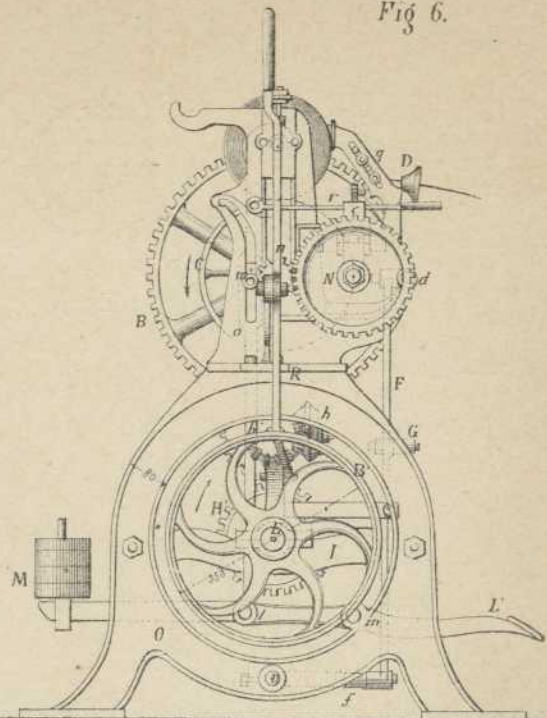


Fig 5.

Escala de 1/2.

Fig 7.

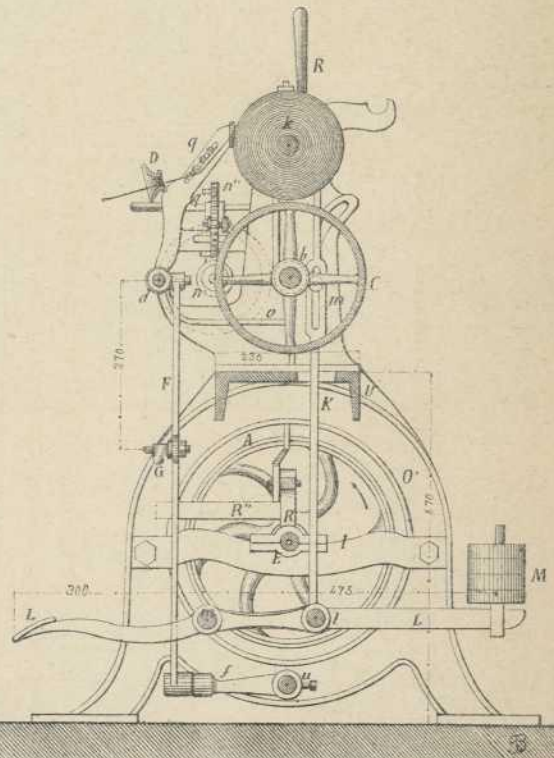
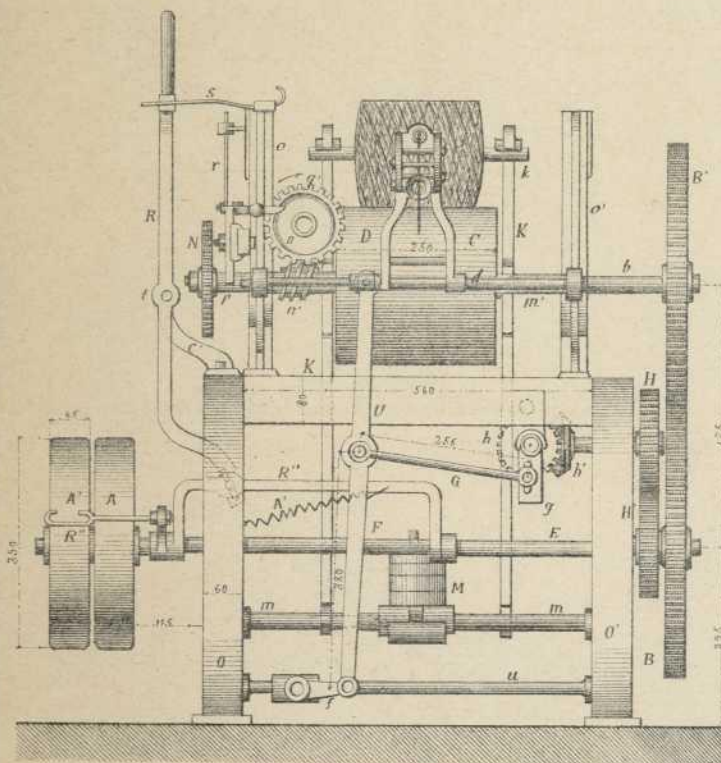


Fig. 2.

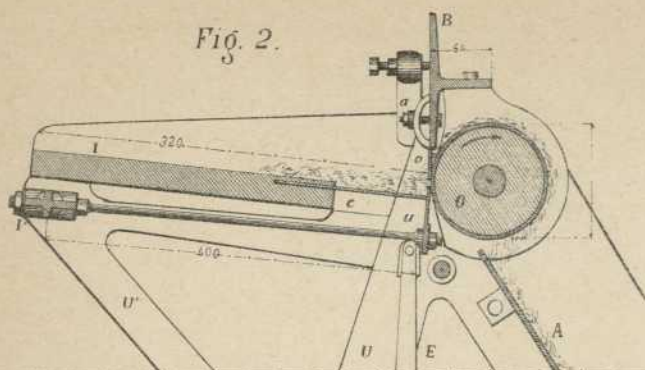


Fig. 1.

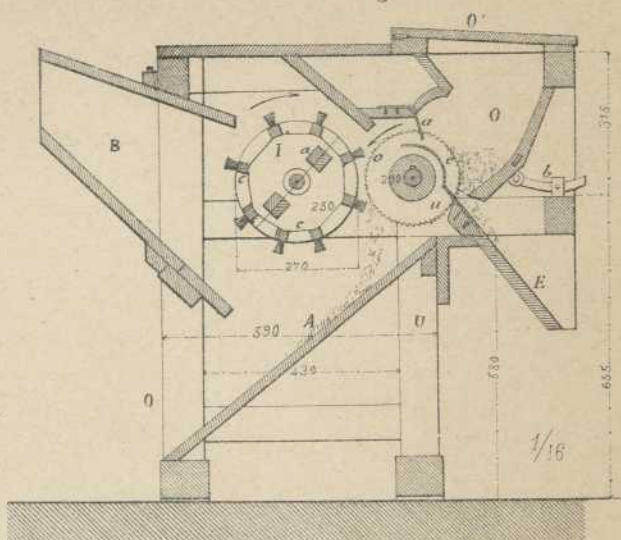


Fig. 3.

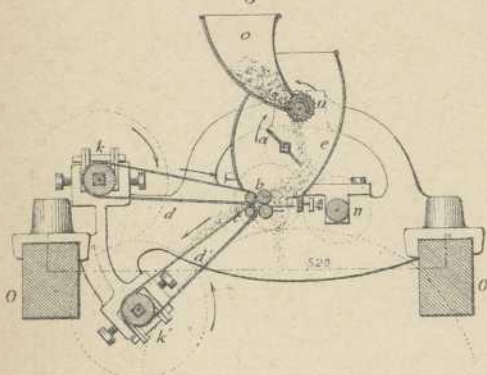


Fig. 4.

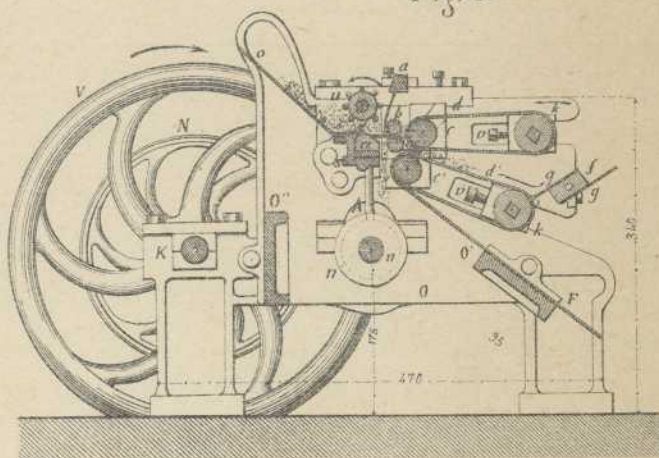


Fig. 6.

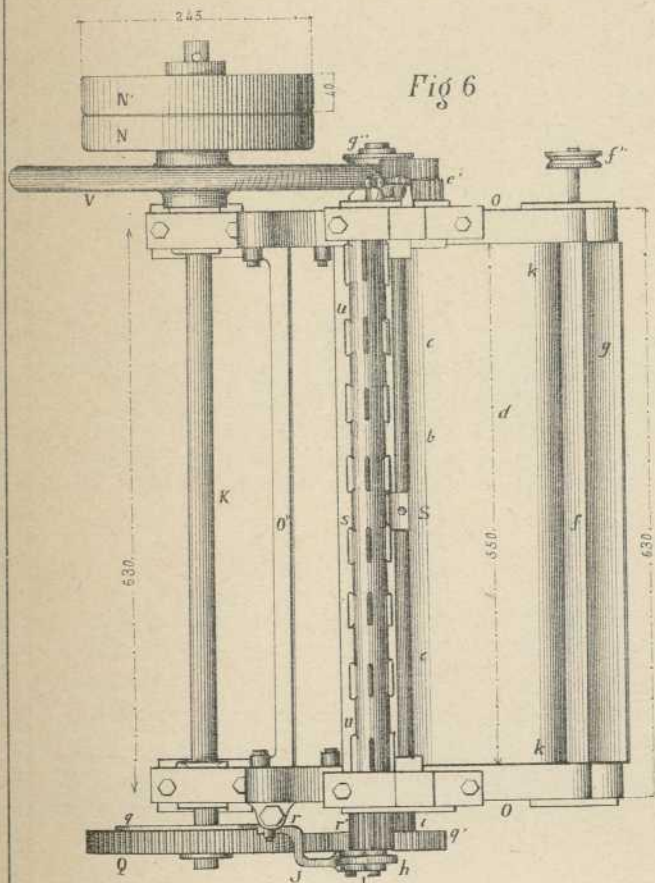
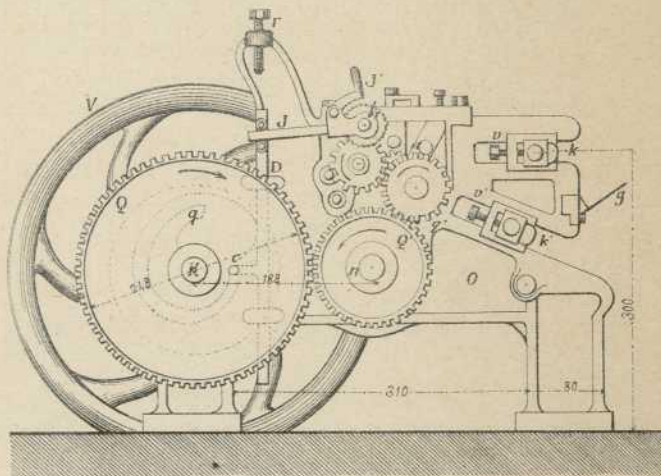


Fig. 5.



Escala de 1/6 para las Fig. 2, 4 a 10.

cent. 10 5 0 1 2 3 4 5 6 7 8 9 10 decimetros.

Fig. 8.

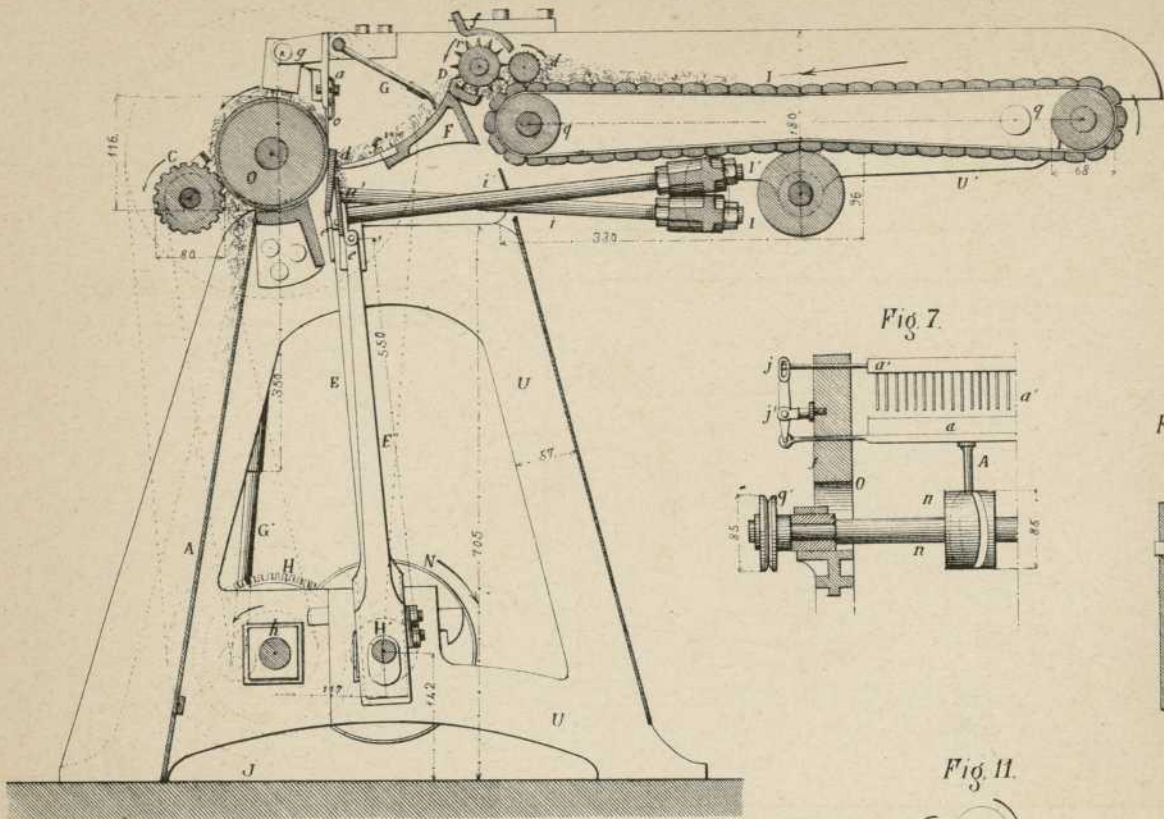


Fig. 7.

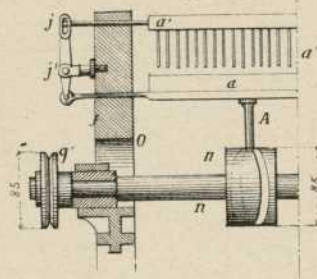


Fig. 10.

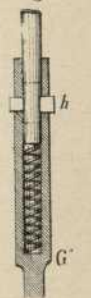


Fig. 11.

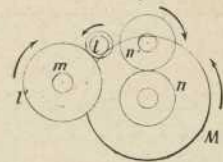
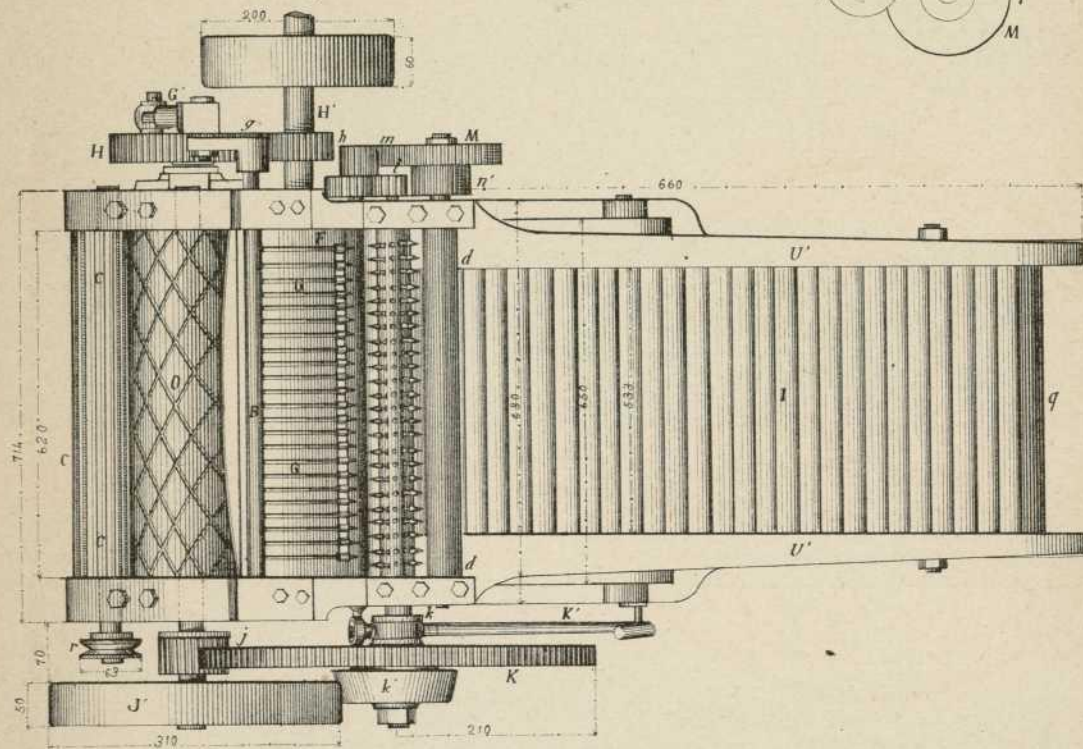


Fig. 9.



Escala de 1/8 para las Fig. 2, 4, y 10.

cent. 10 5 0 1 2 3 4 5 6 7 8 9 10 Decímetros.

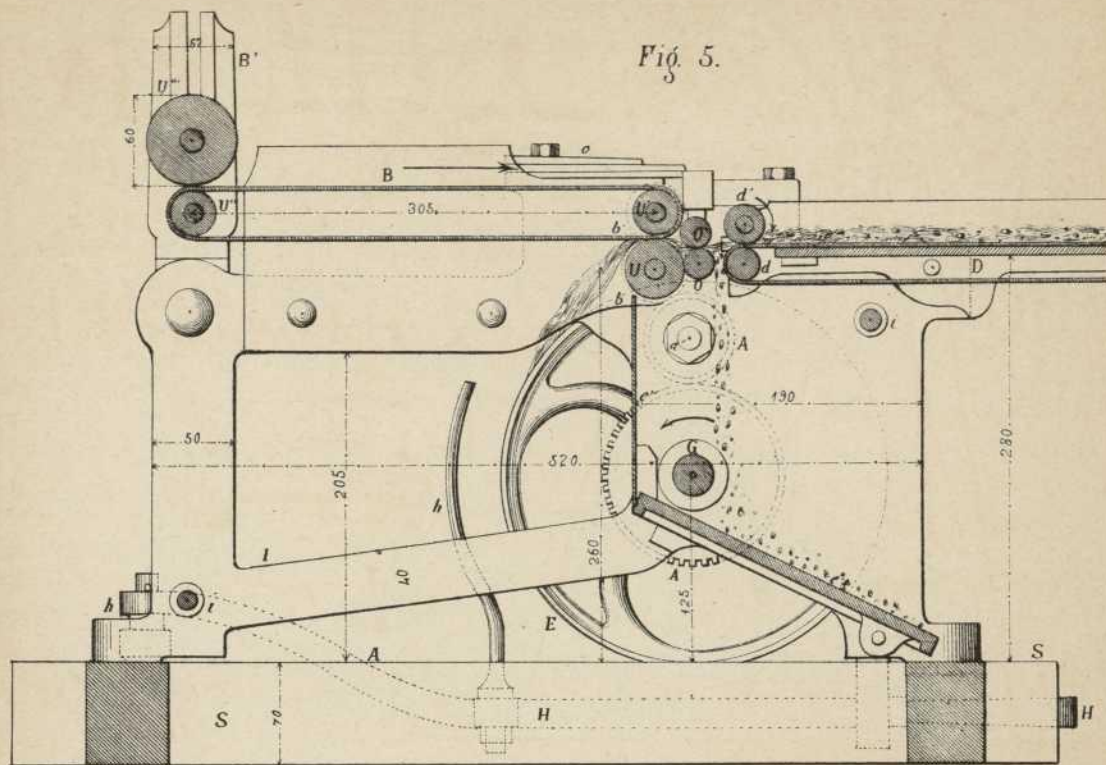


Fig. 5.

Fig. 1.

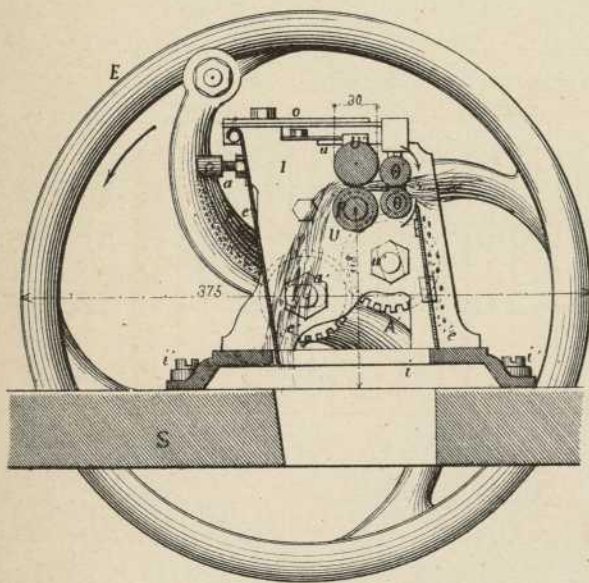
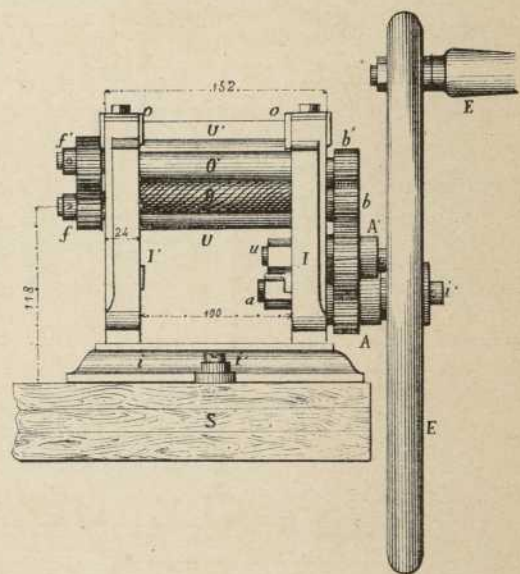


Fig. 2.



Escala de 1/5

Centímetros 10 5 0 1 2 3 4 5 6 Decímetros

Fig. 3.

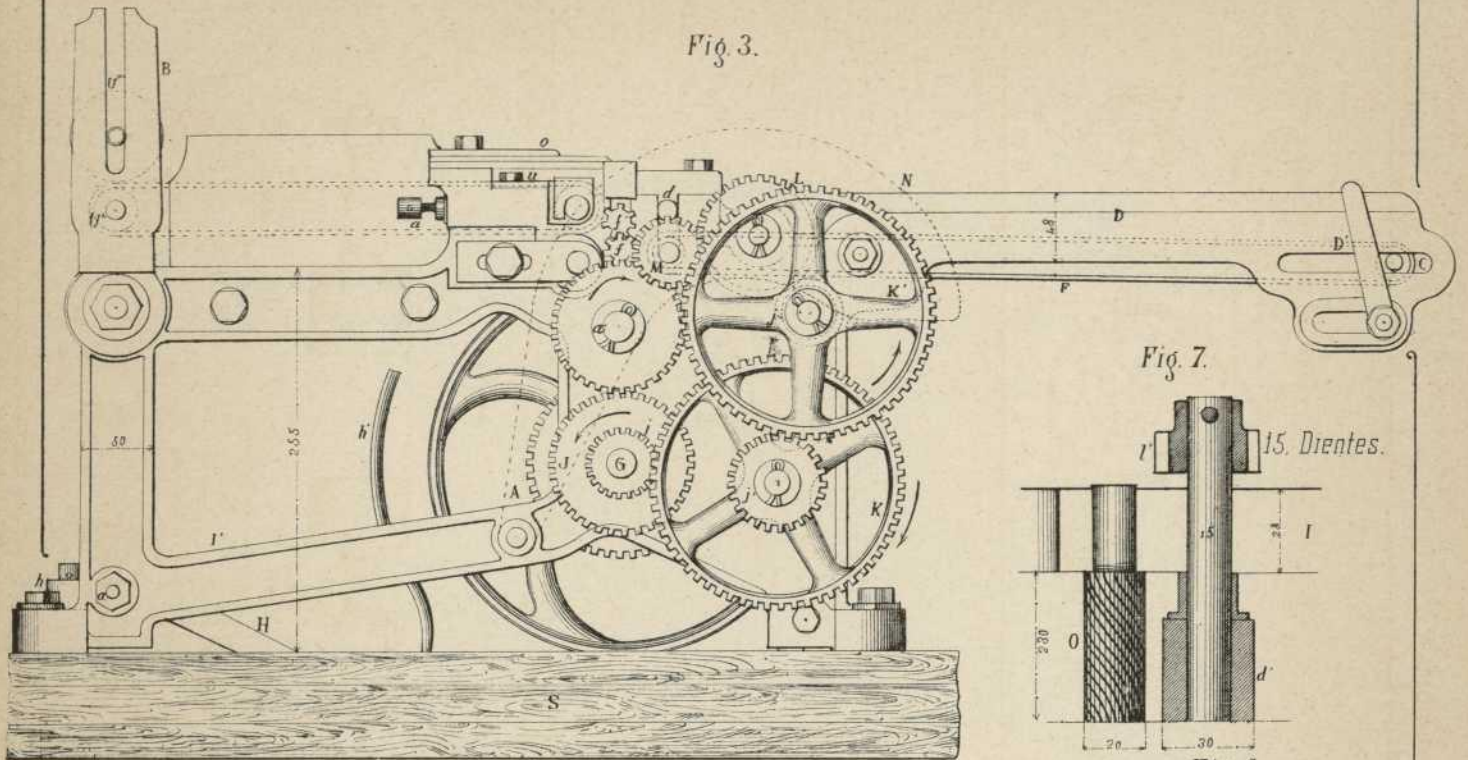


Fig. 7.

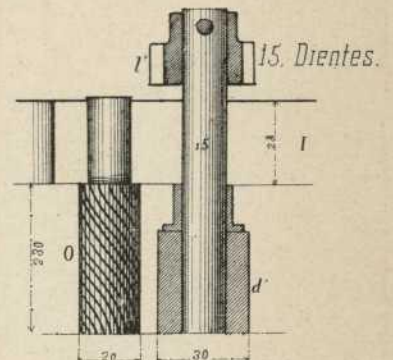


Fig. 4.

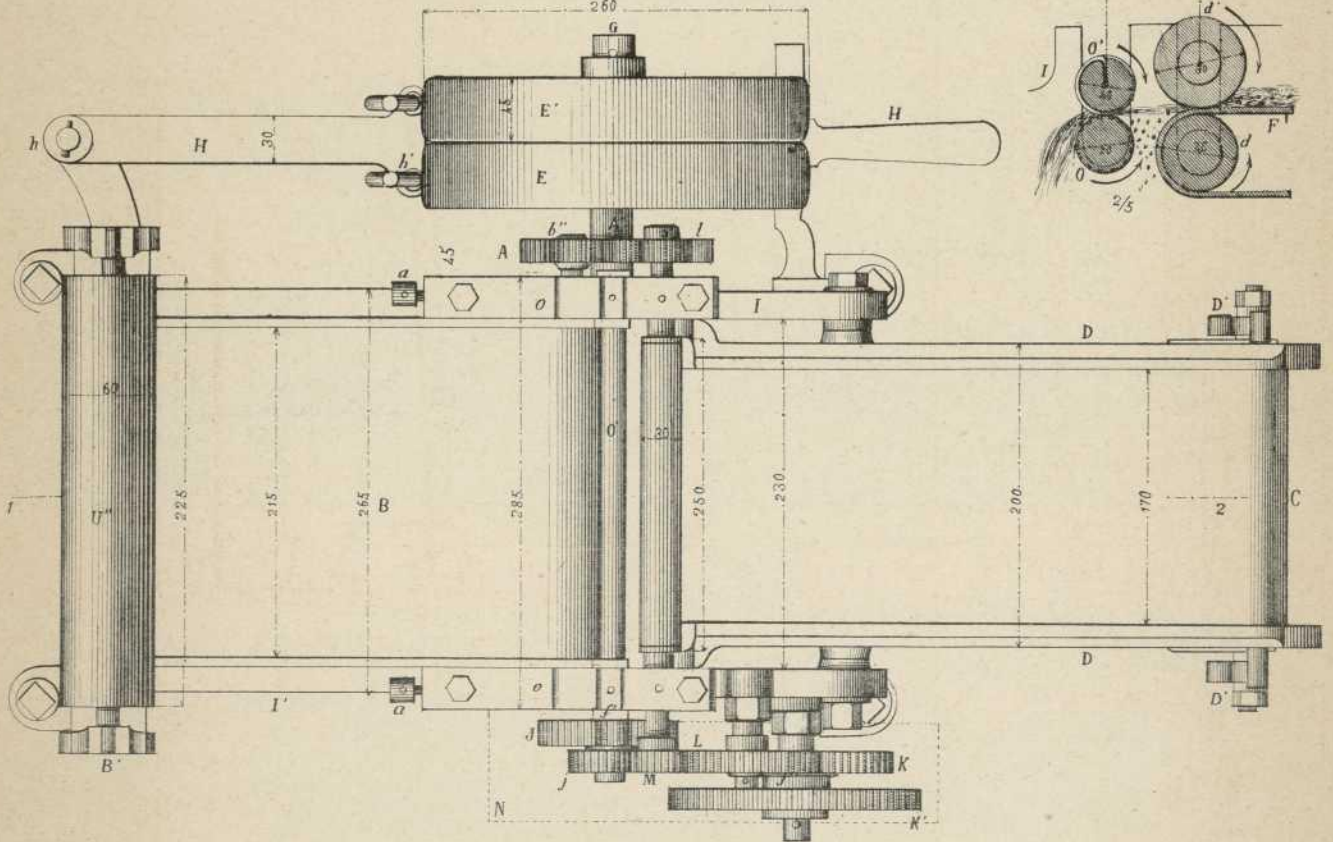
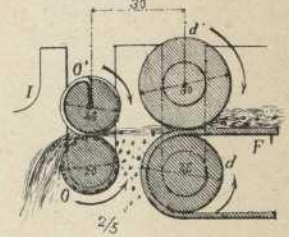
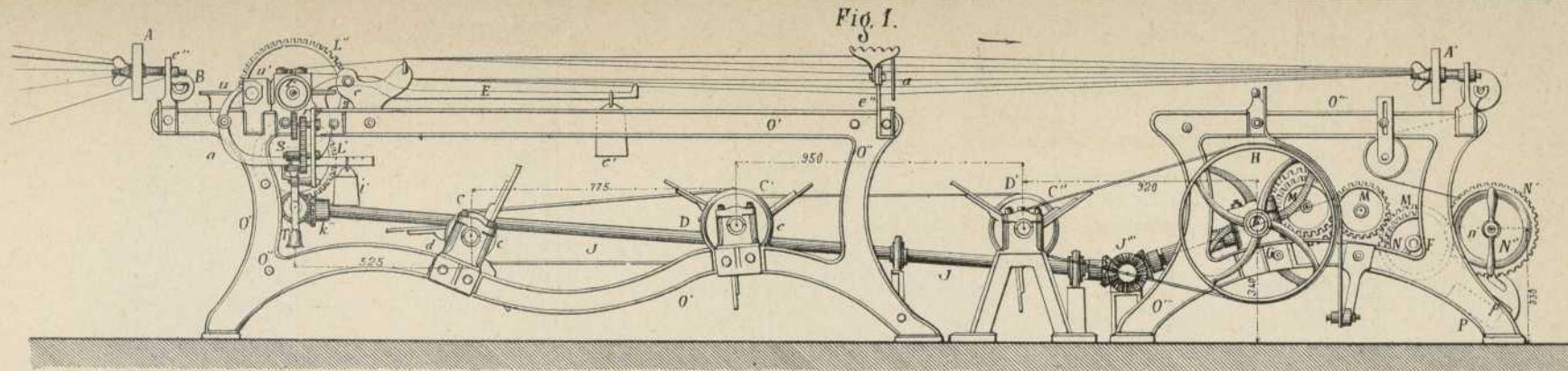


Fig. 6.



Escala de 1/5

Cent^{as} 10 5 0 1 2 3 4 5 6 decimetros.



Continuacion de la Fig. 1.

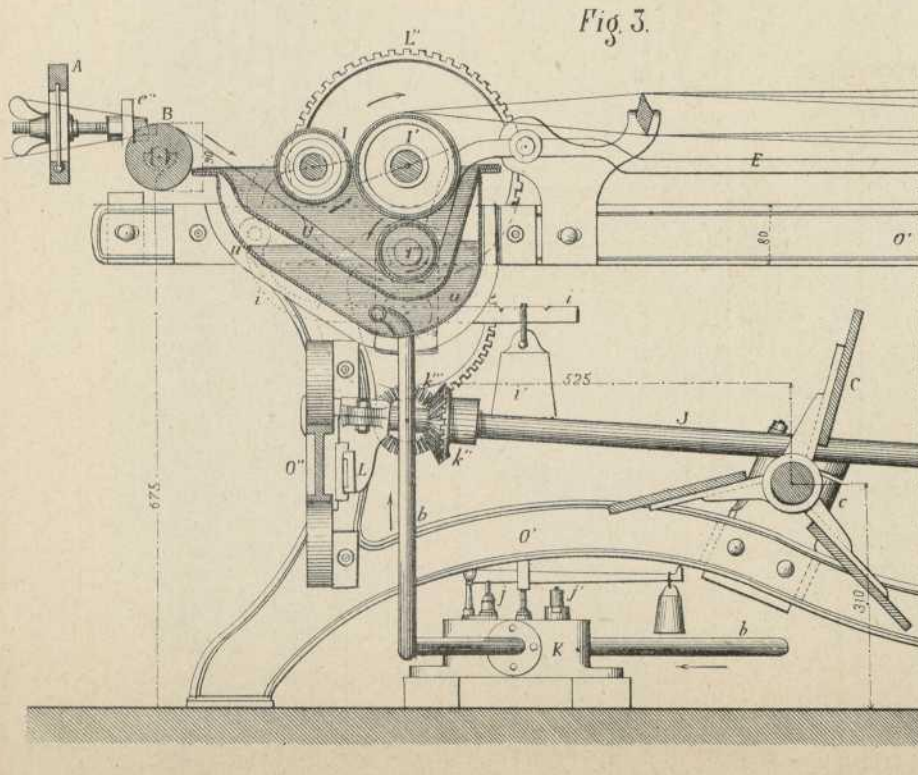
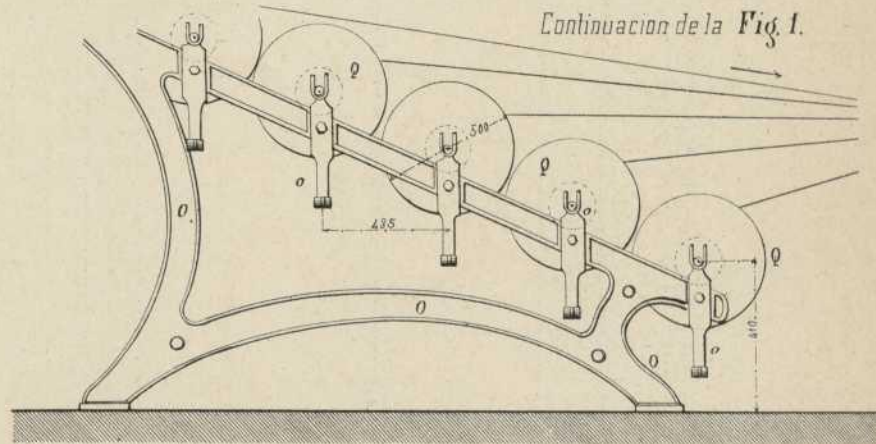
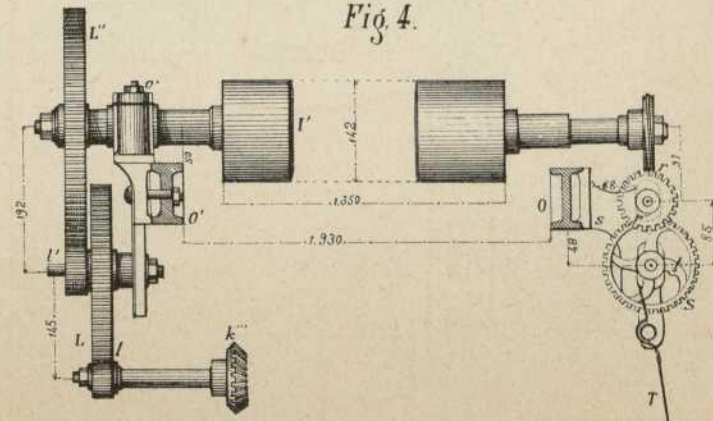


Fig. 4.



Escala de 1/20 por las Fig. 1. y 2.

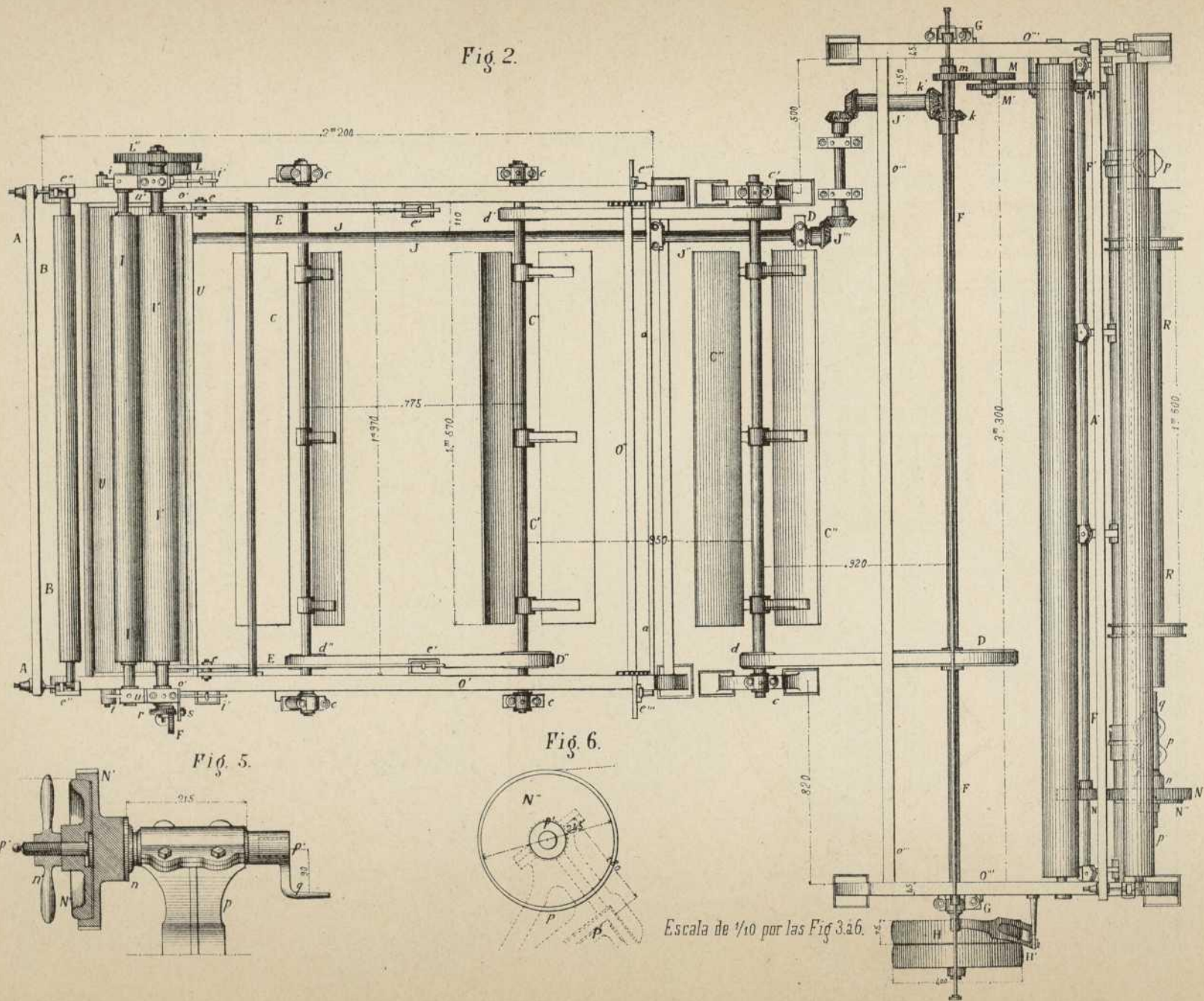


Fig. 1.

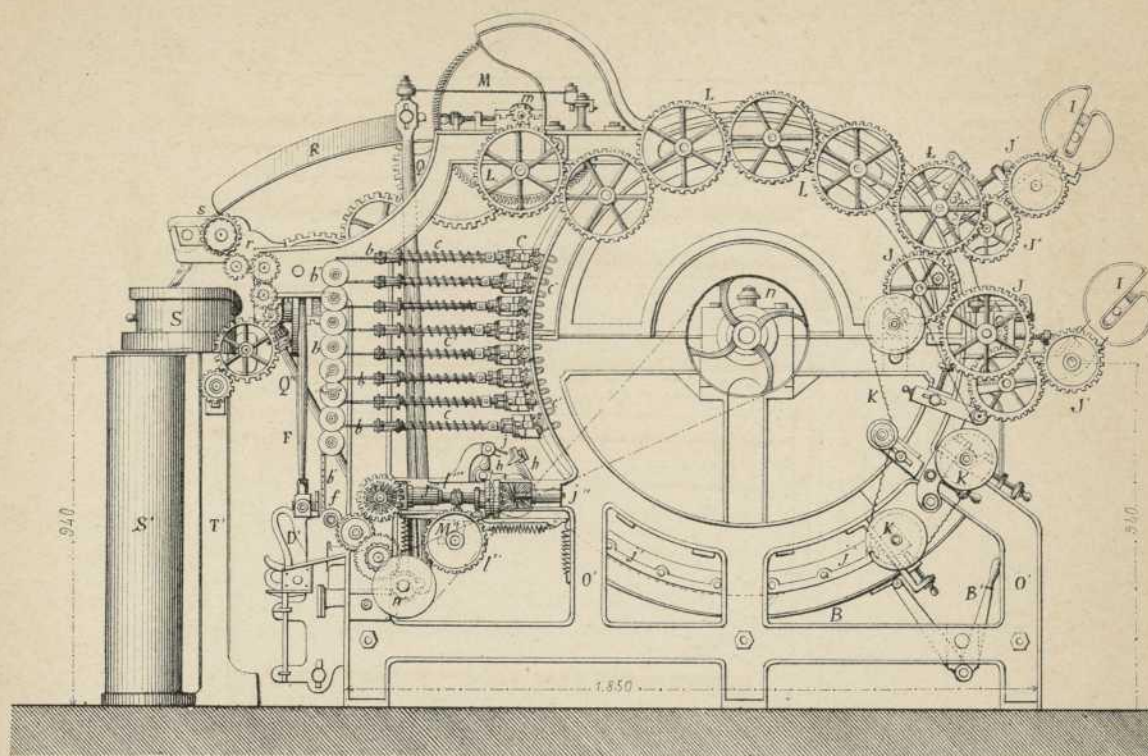


Fig. 2.

Fig. 4.

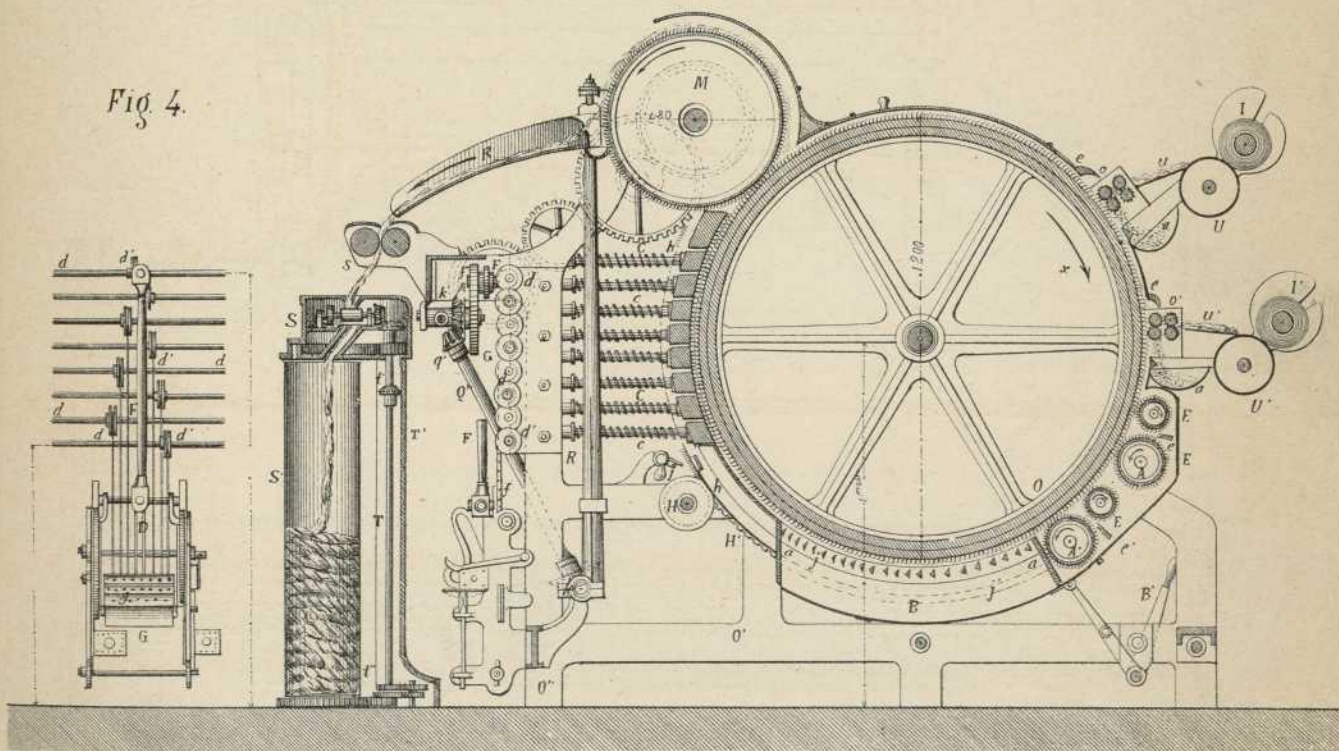


Fig. 3.

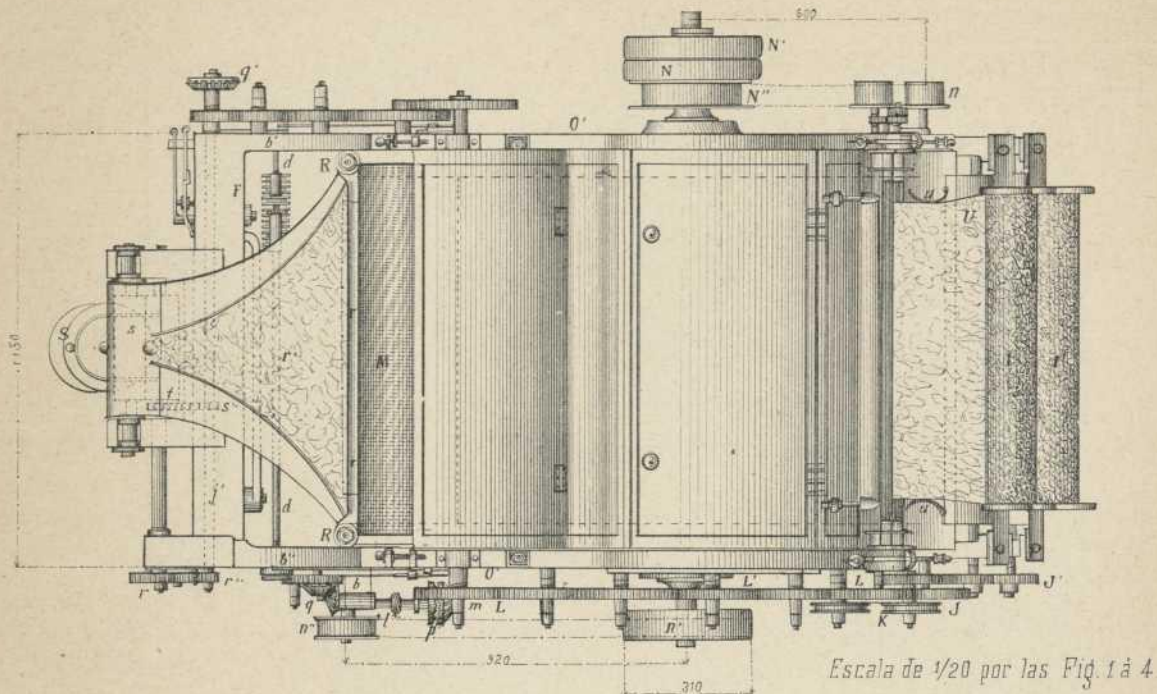


Fig. 5.

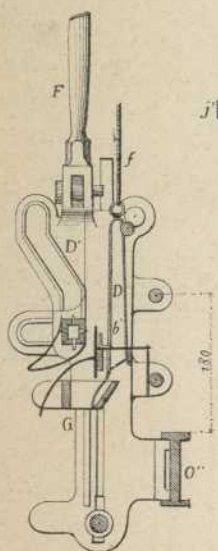


Fig. 6.

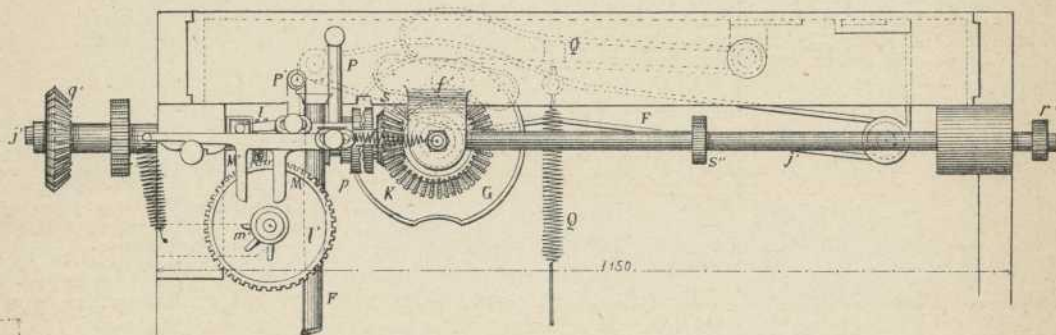
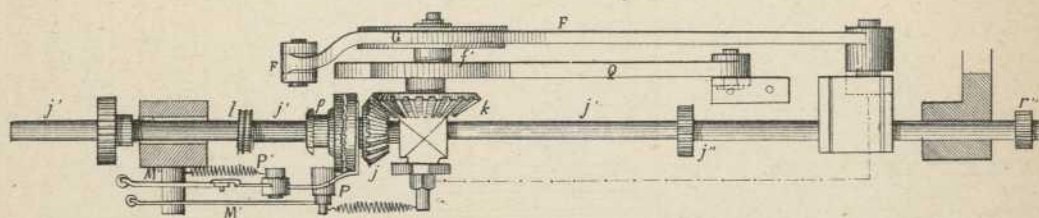


Fig. 7.



Escala de 1/10 por las Fig. 5 à 7.

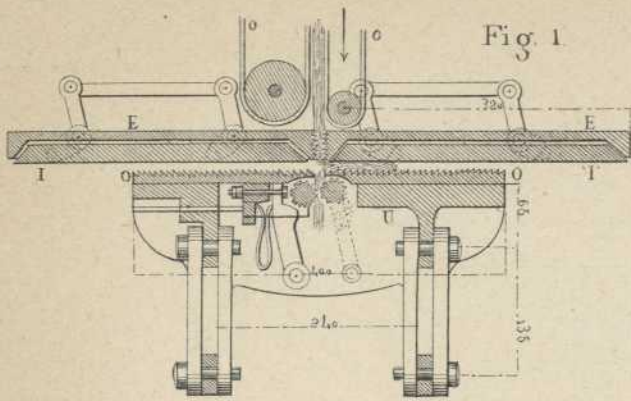


Fig. 1.

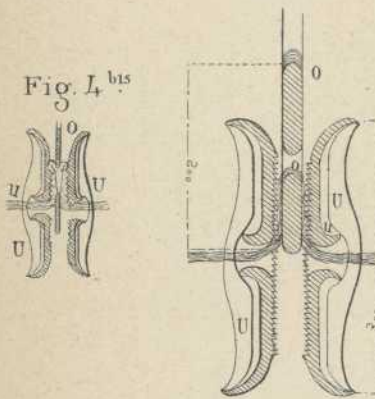
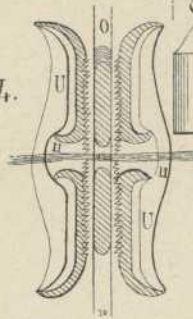


Fig. 4 bis

Fig. 4.



1/8

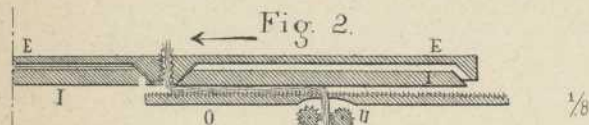


Fig. 2.

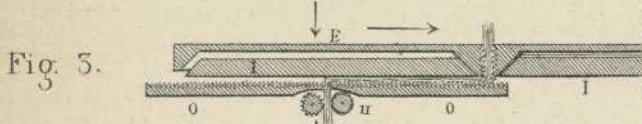


Fig. 5.

Fig. 5.

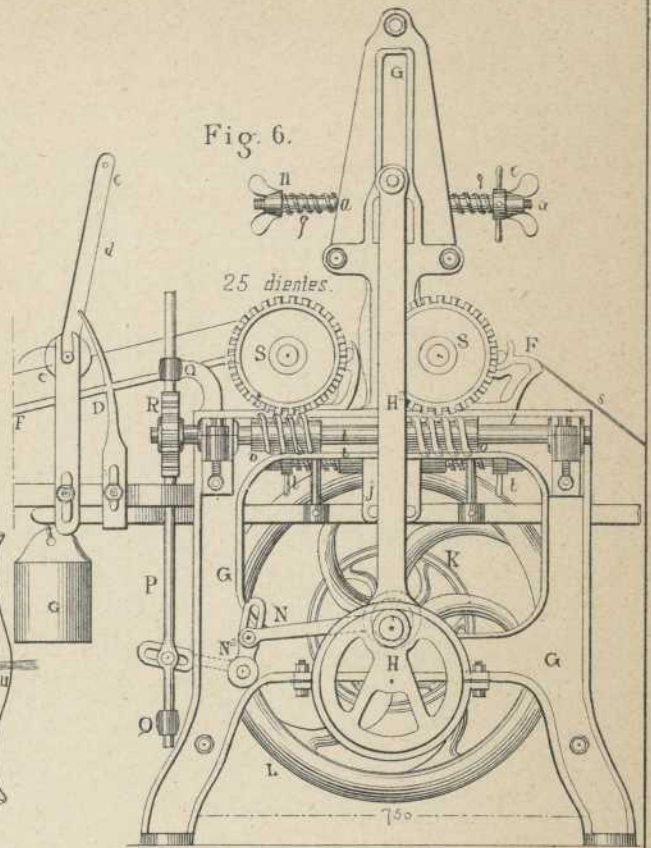
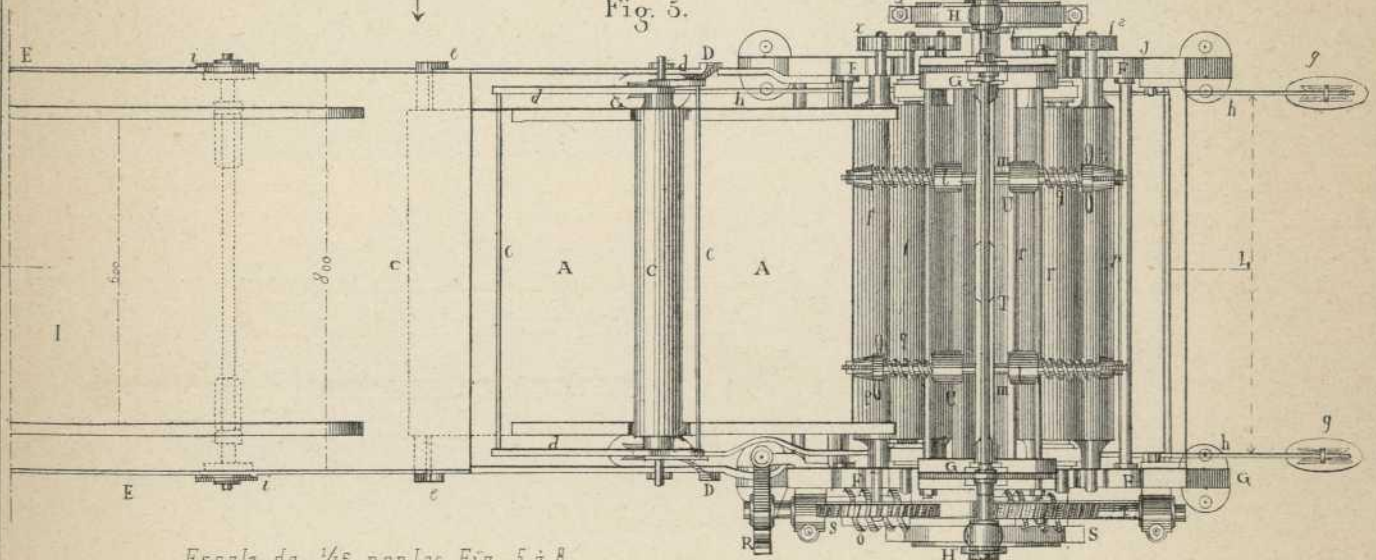


Fig. 6.

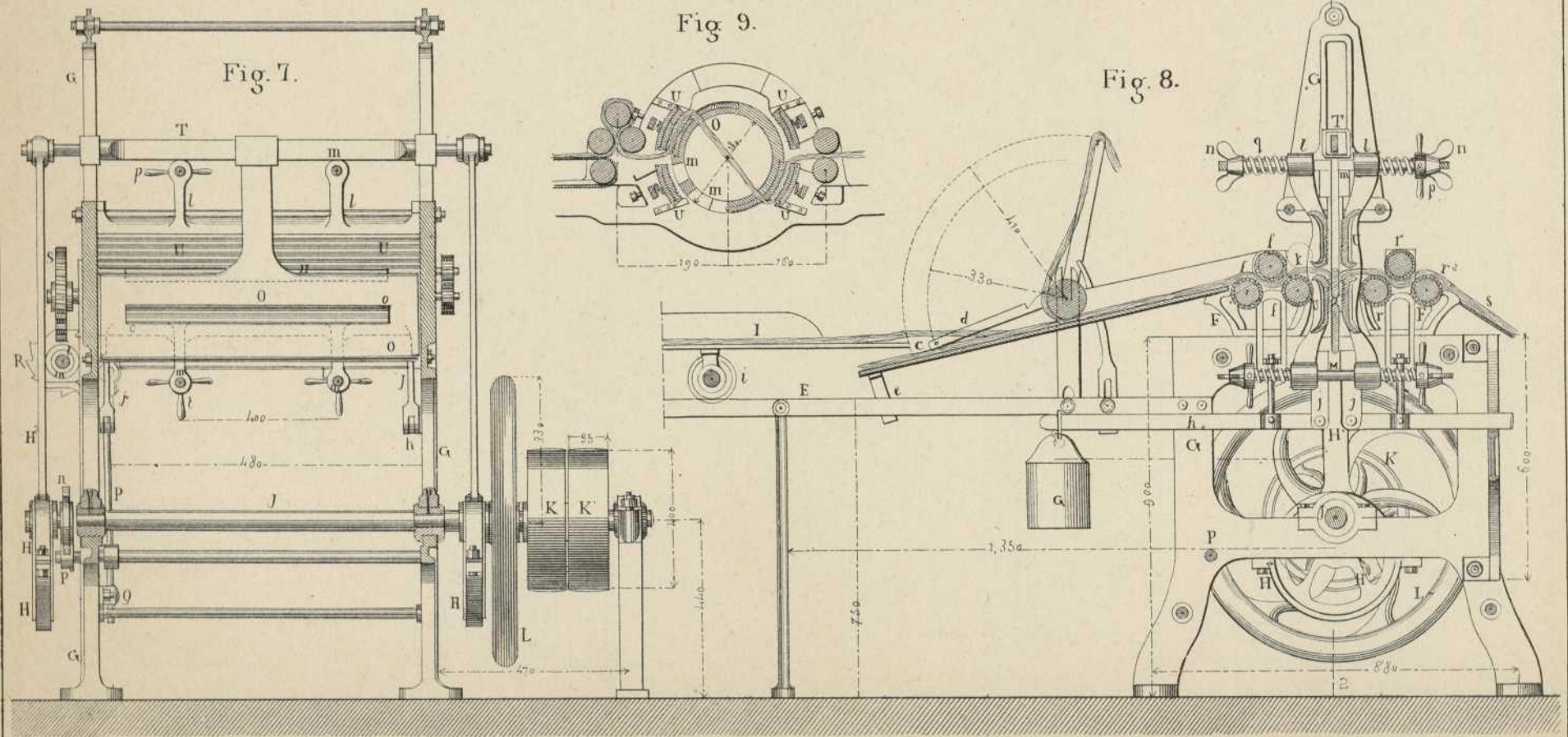
25 dientes.

750



Escala de 1/15 por las Fig. 5 à 8.

A.R.



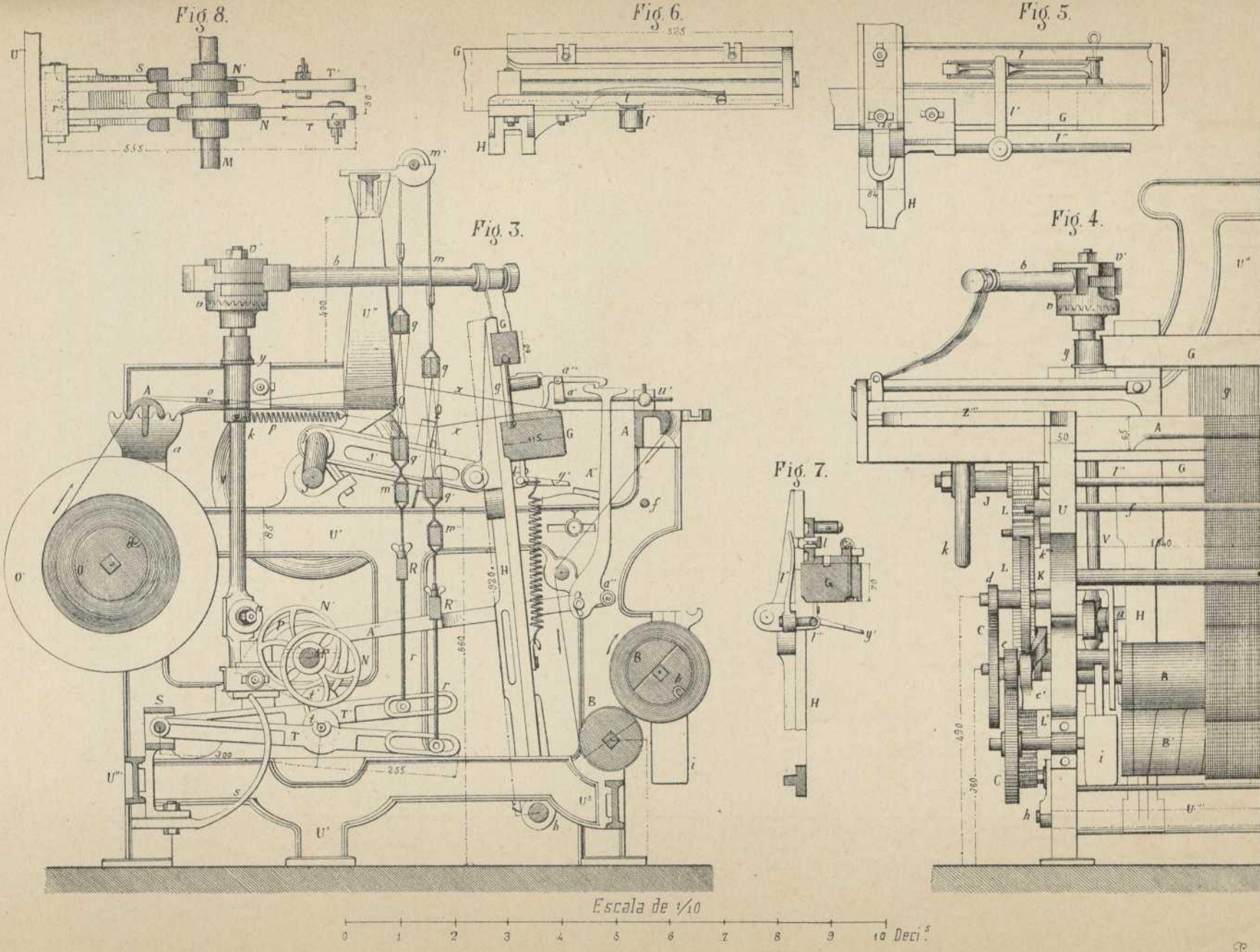


Fig 1.

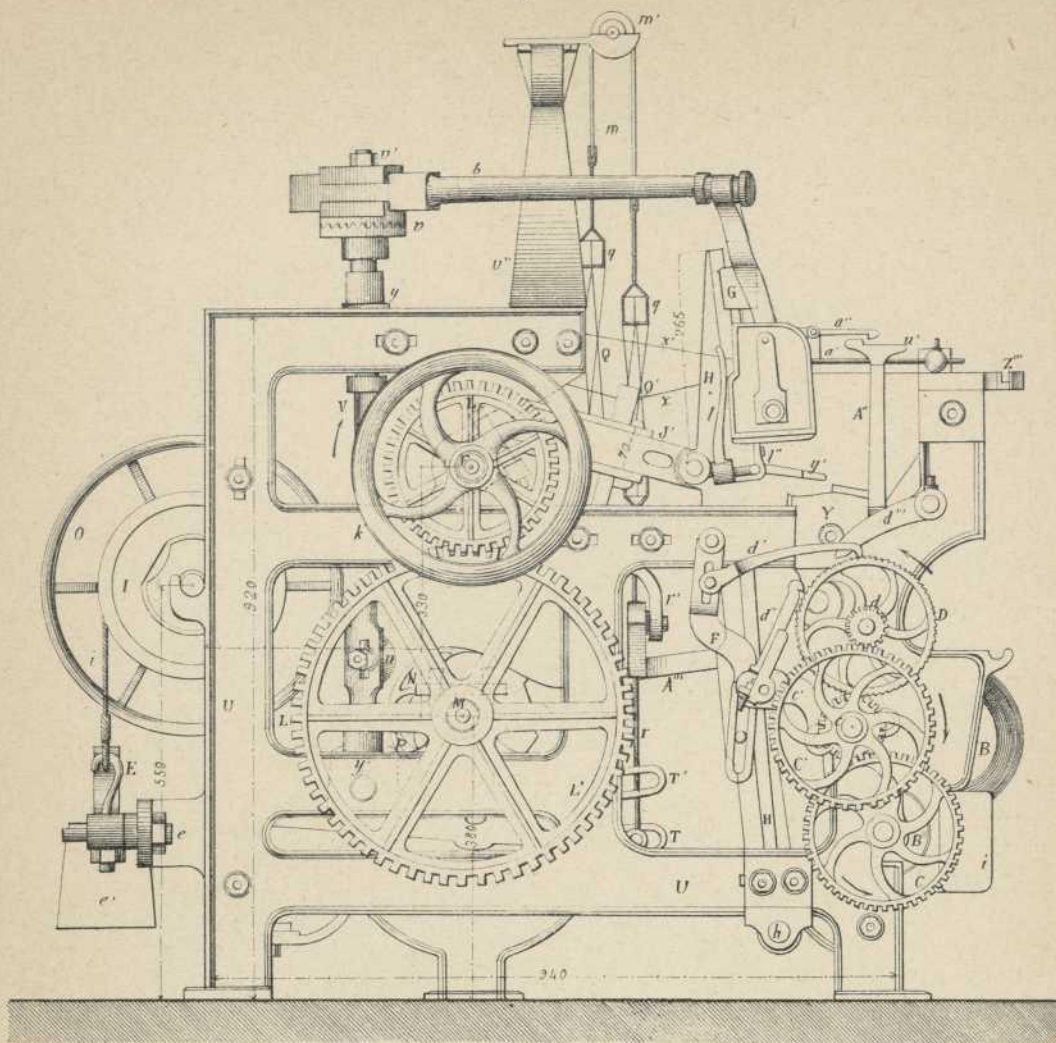
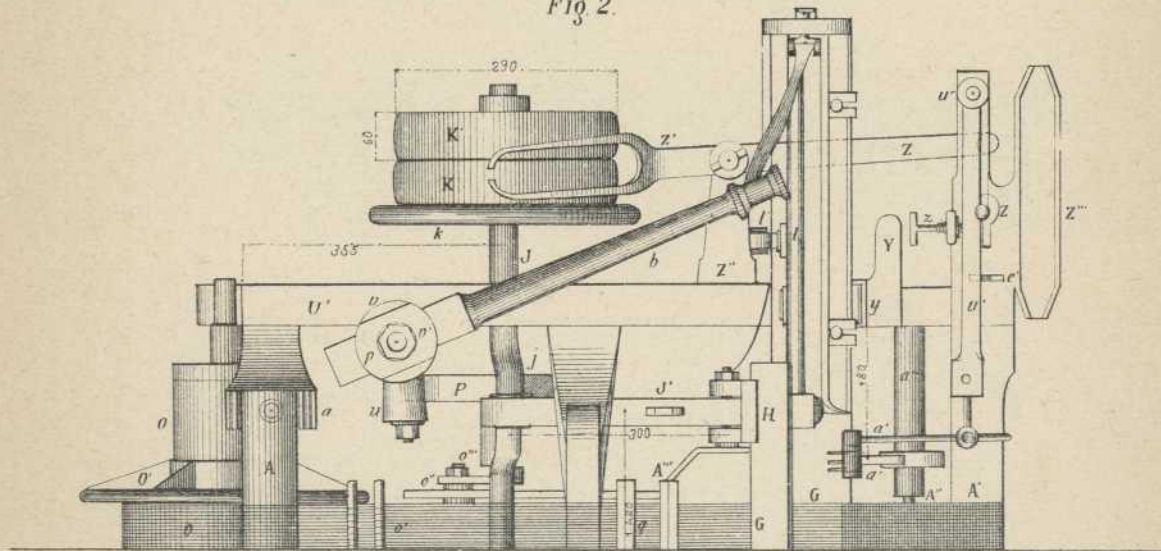
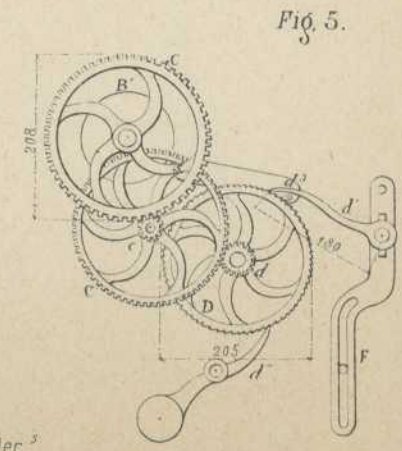
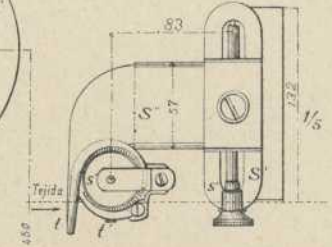
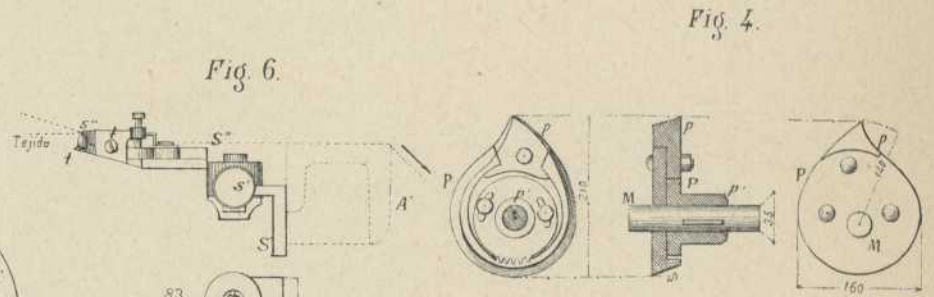
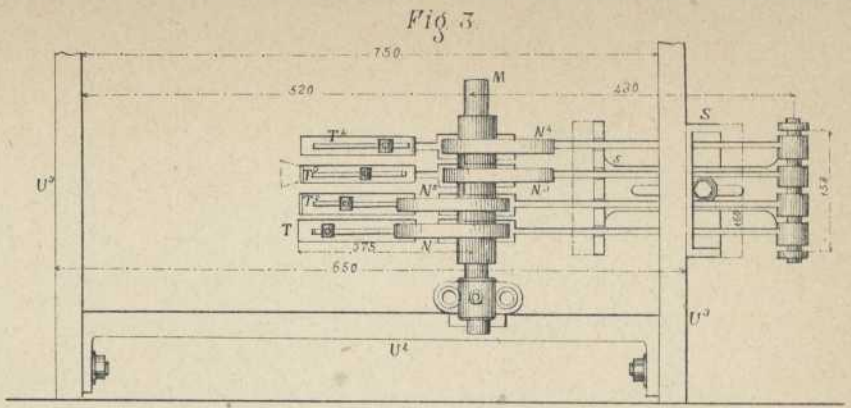
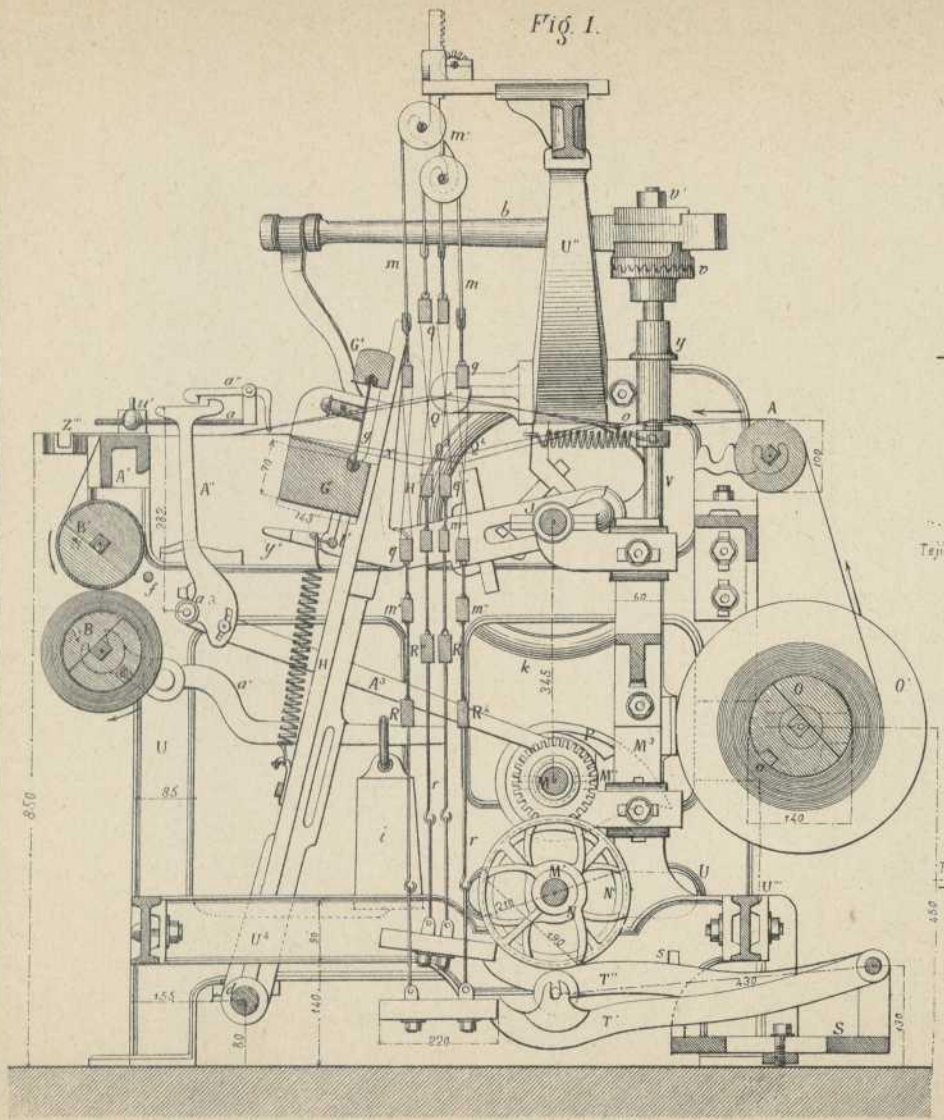


Fig 2.



Escala de $\frac{1}{10}$

0 1 2 3 4 5 6 7 8 9 10 Decimetros



Escala de 1/10

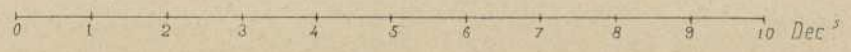
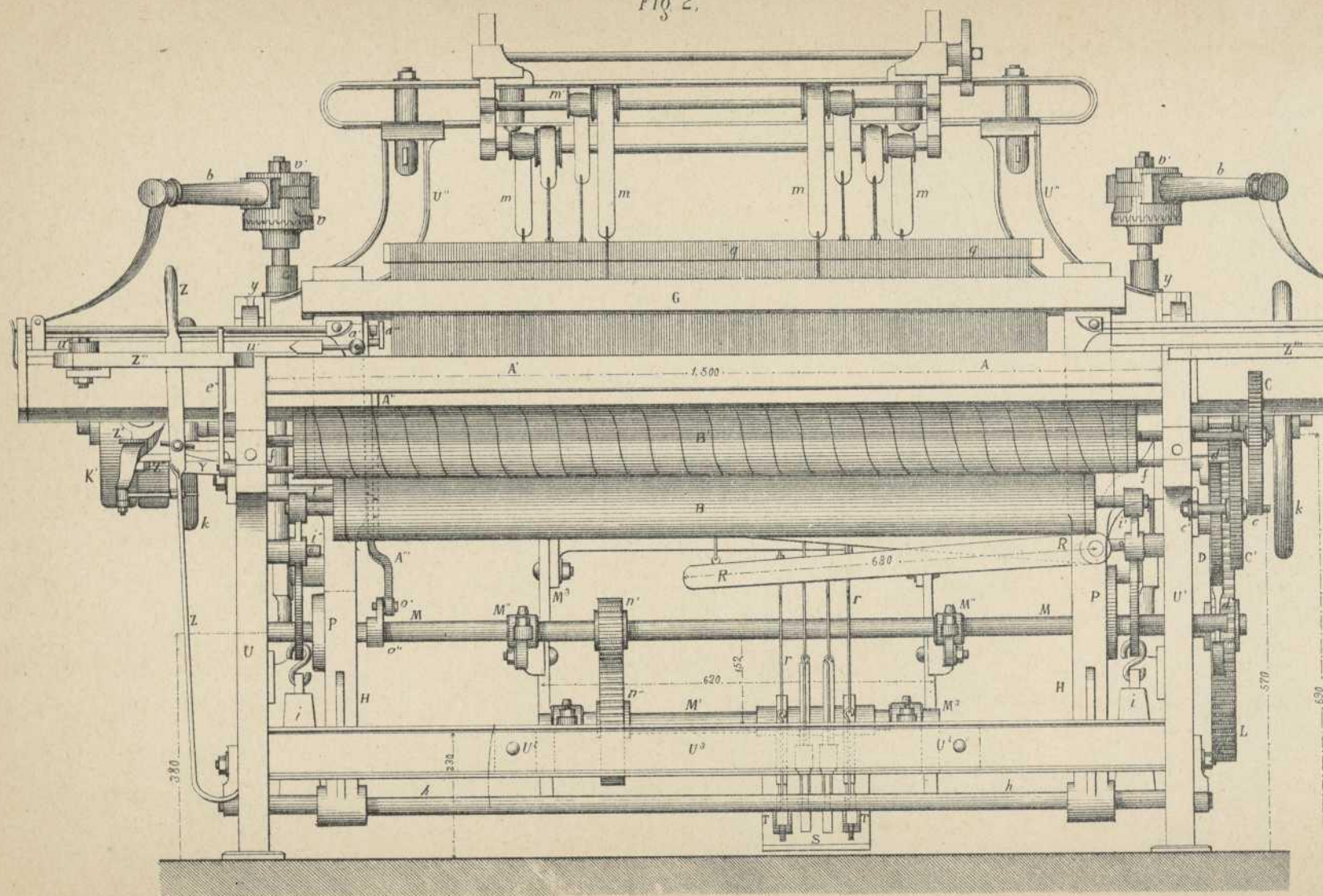


Fig 2.



Escala de 1/10

0 1 2 3 4 5 6 7 8 9 10 Dec^s

Fig. 4.

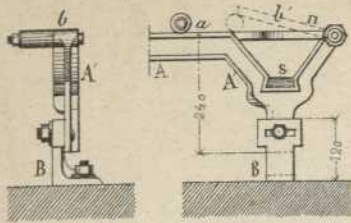


Fig. 1.

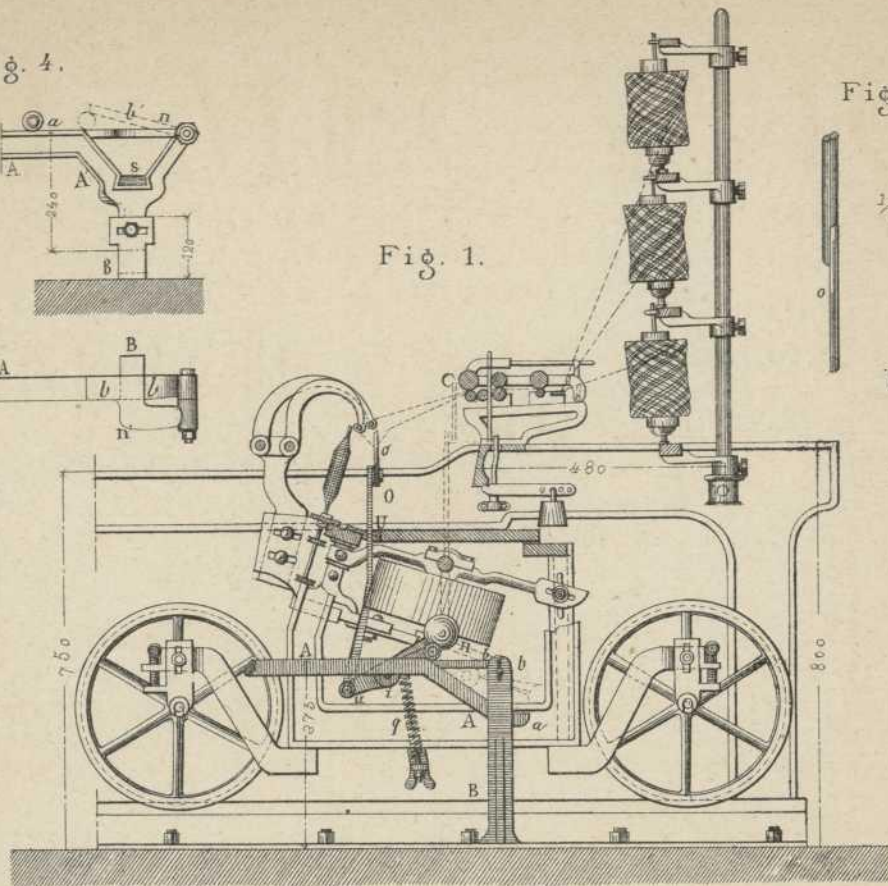


Fig. 7.

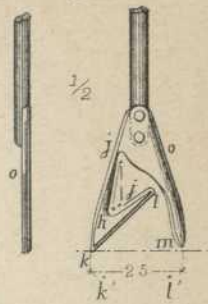


Fig. 10.

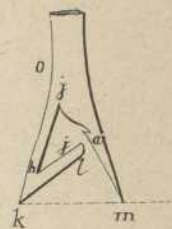


Fig. 3.

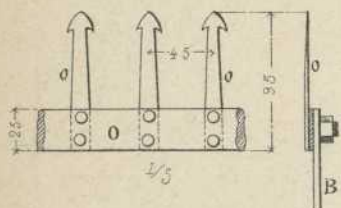
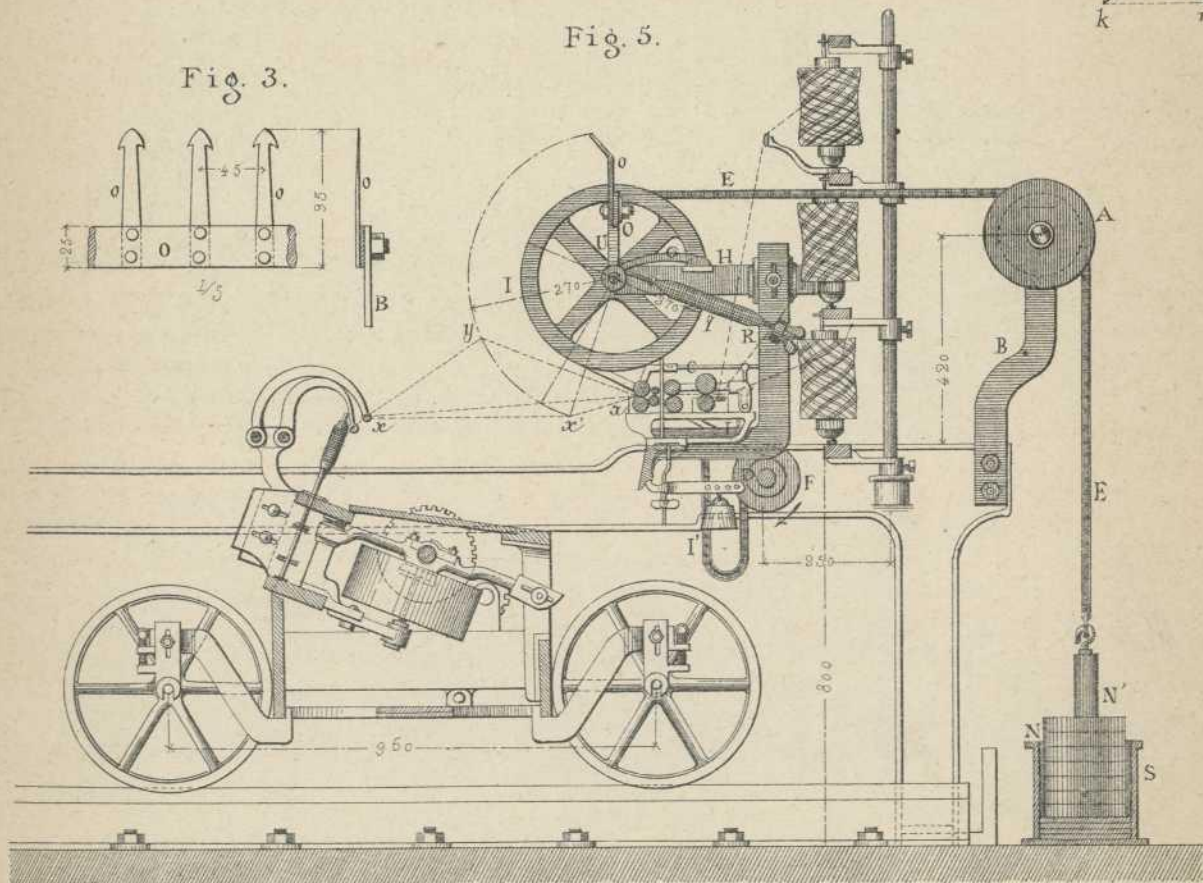


Fig. 5.



⊗

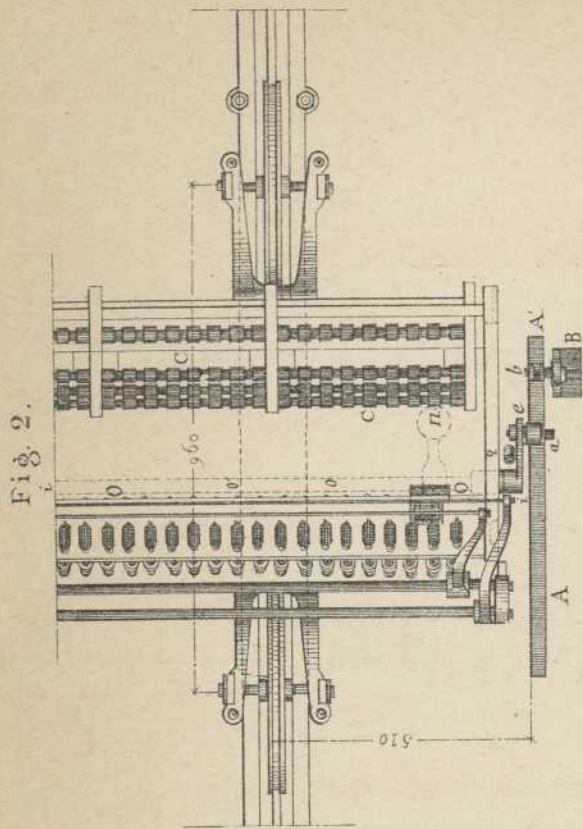


Fig. 2.

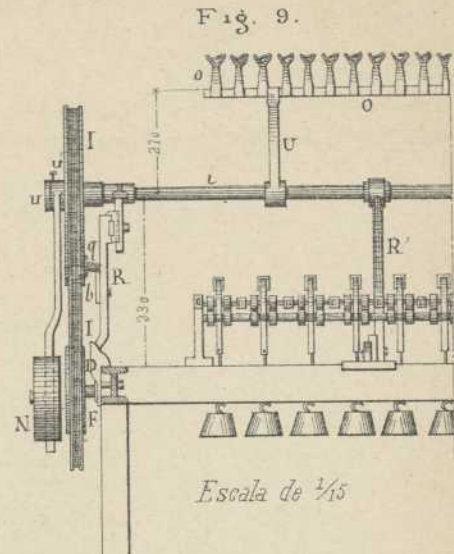


Fig. 9.

Escala de 1/5

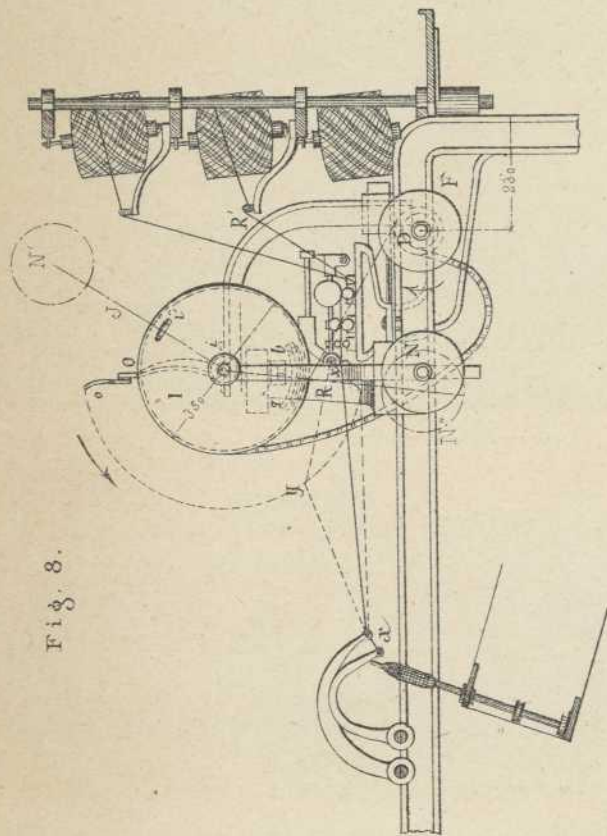


Fig. 8.

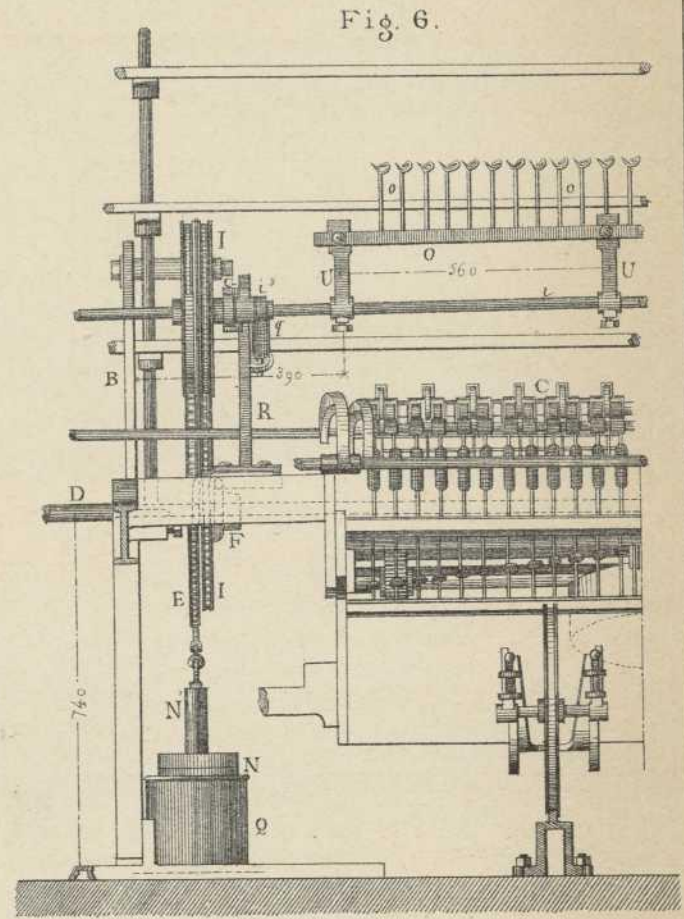


Fig. 6.

Fig. 1.

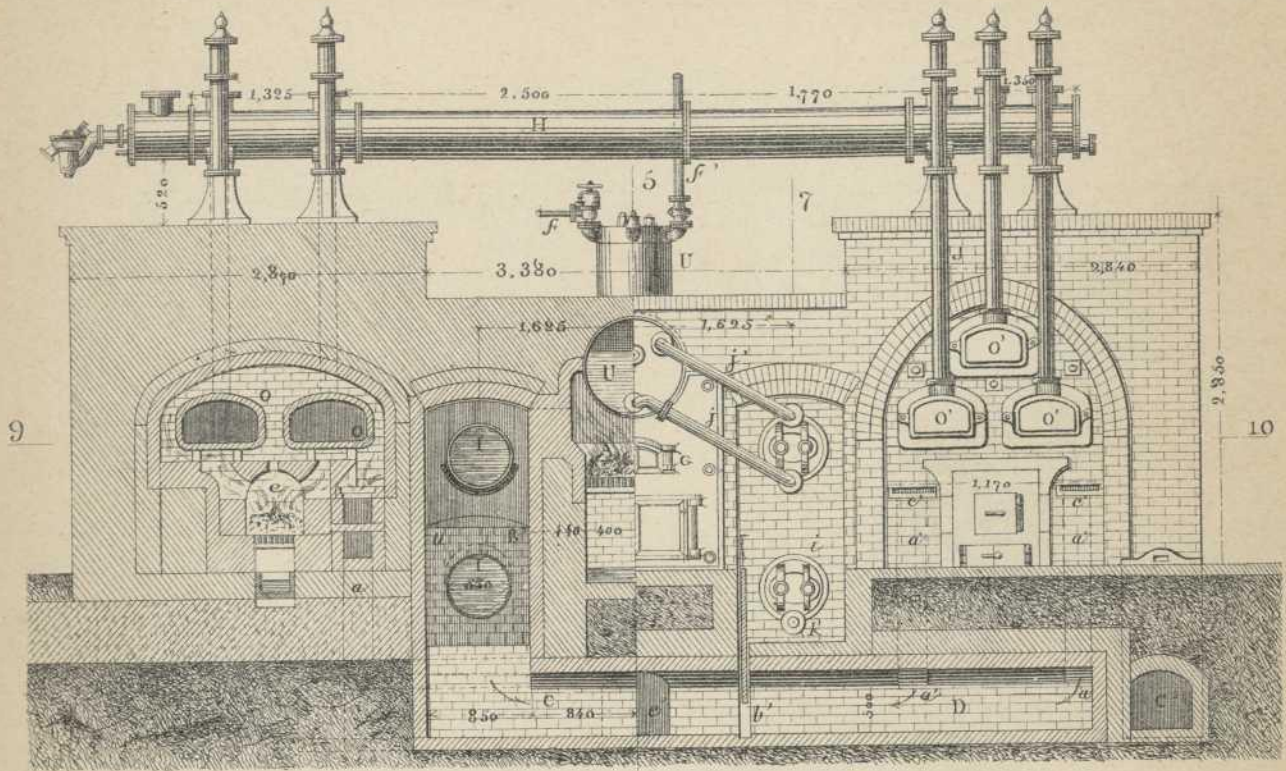


Fig. 2.

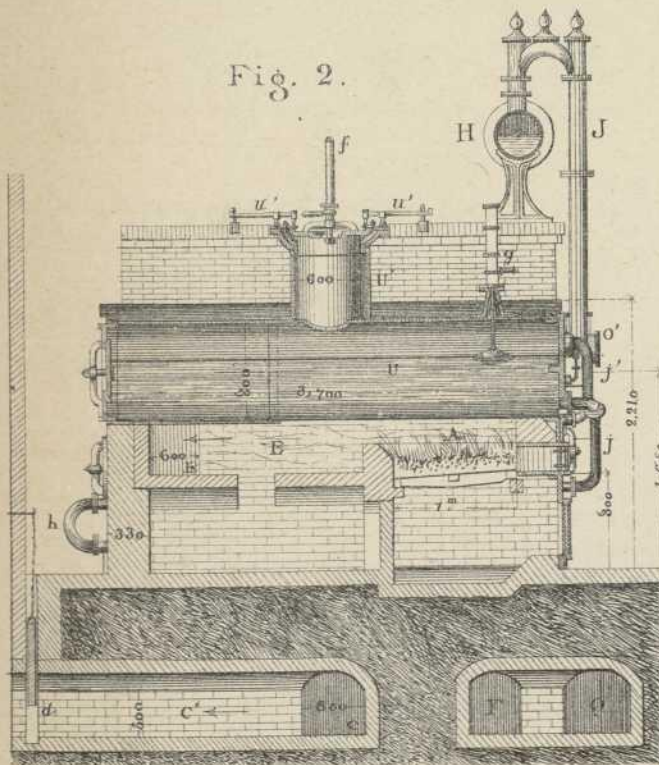
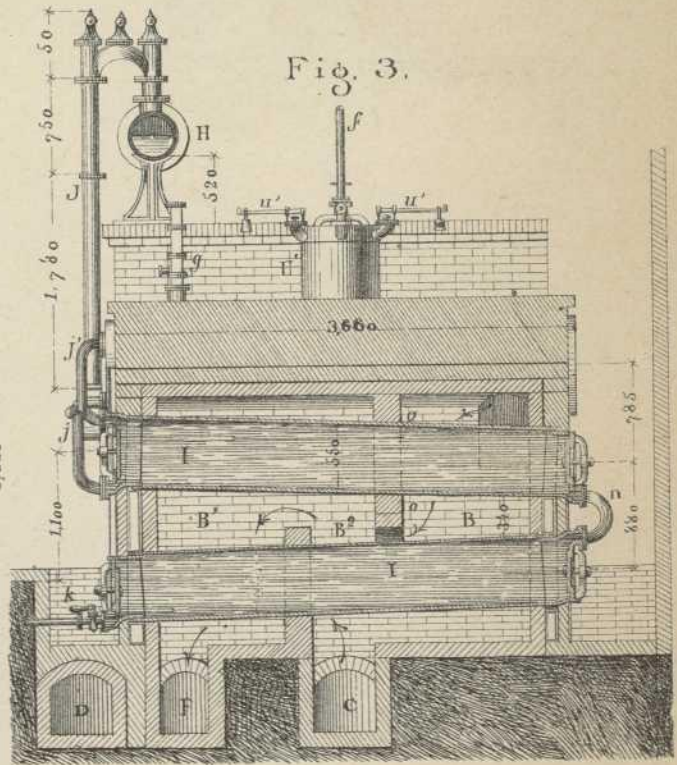


Fig. 3.



⌘

Fig. 6.

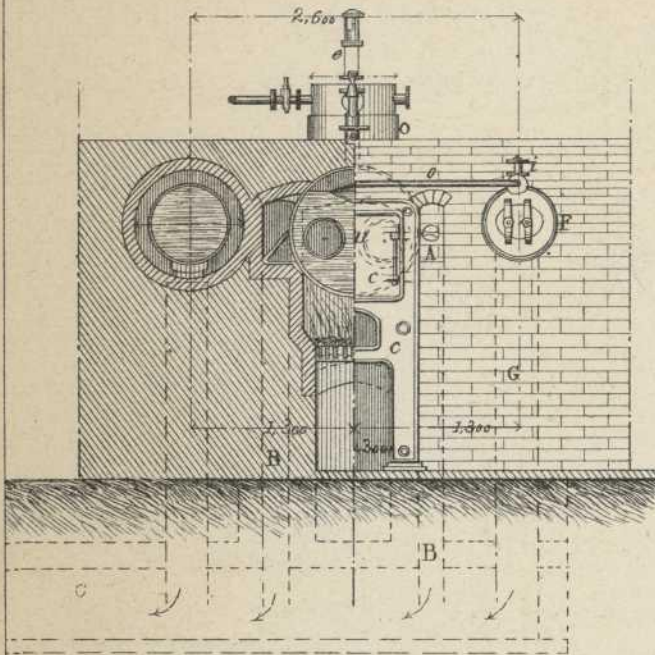


Fig. 5.

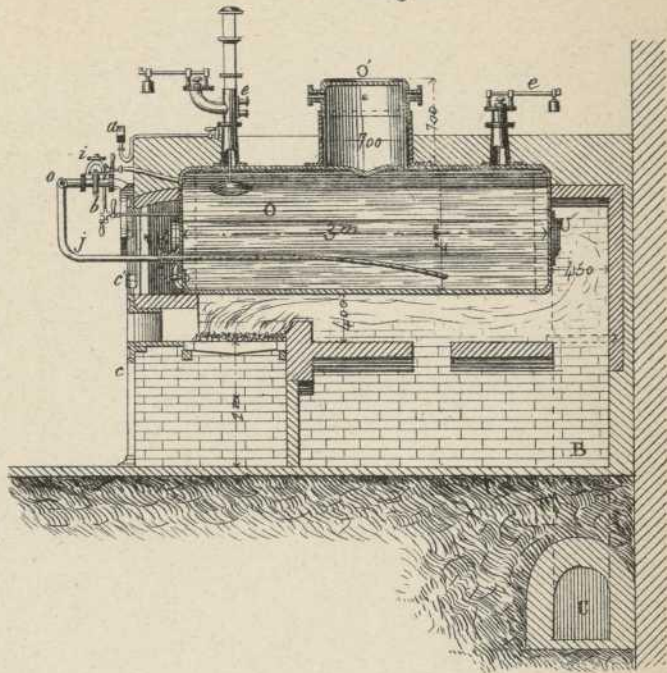
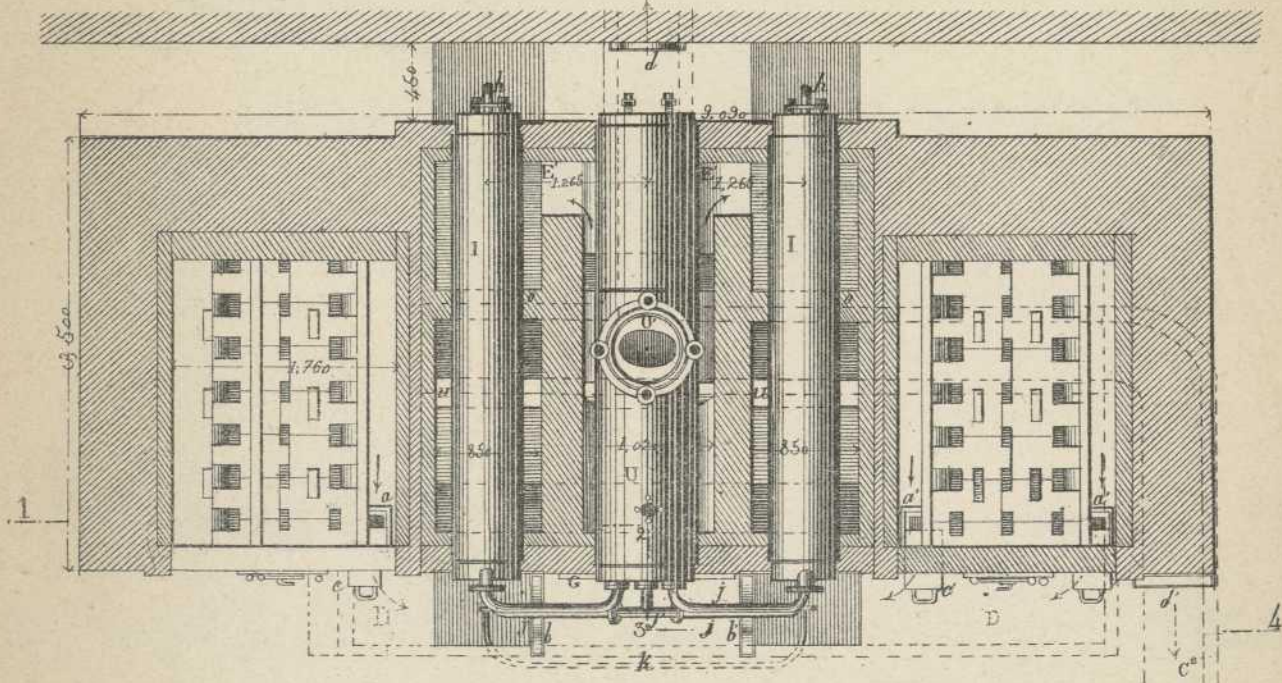


Fig. 4.



H. E.

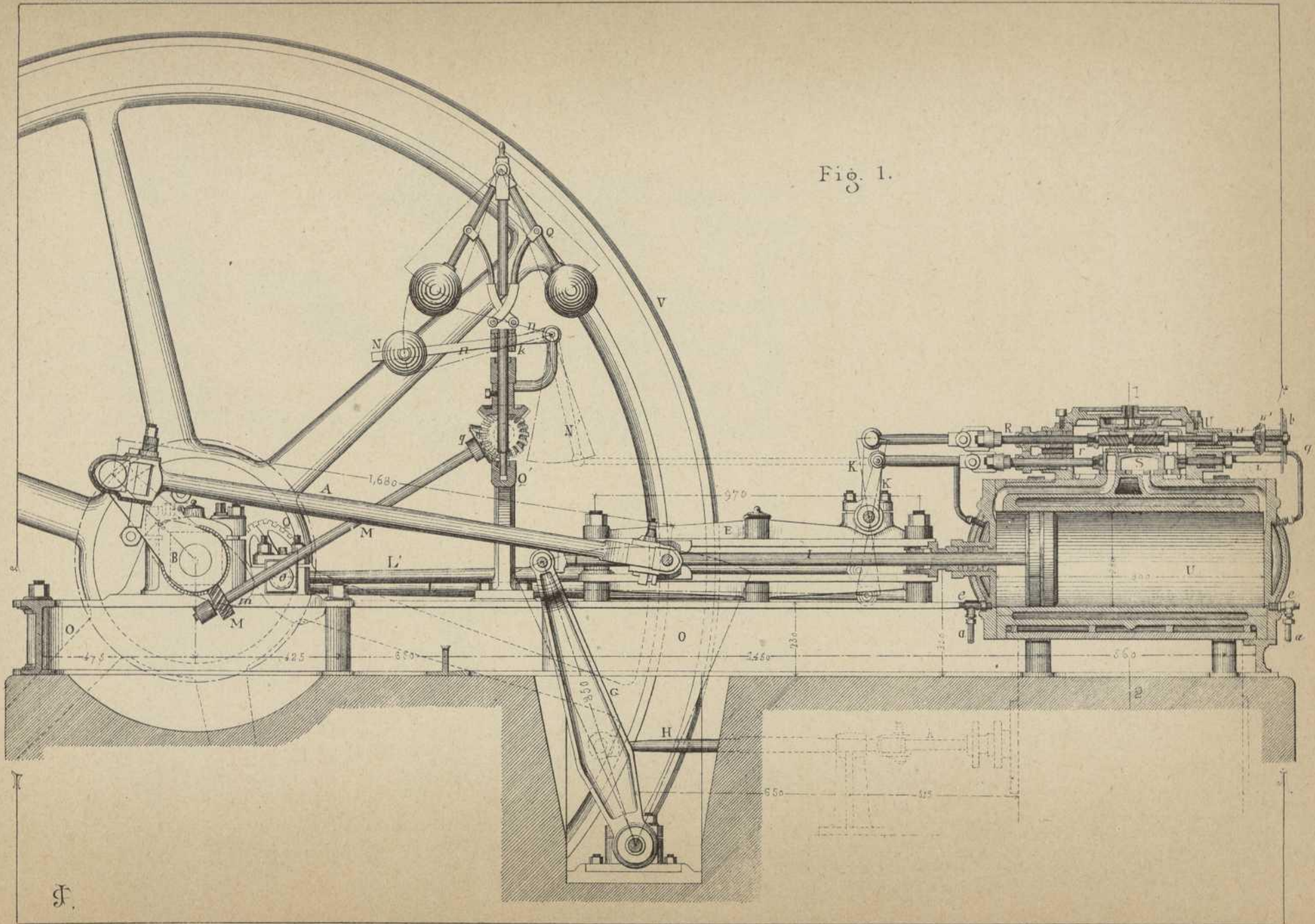
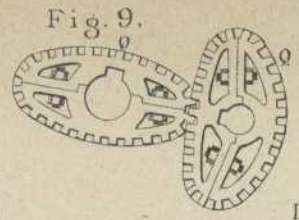
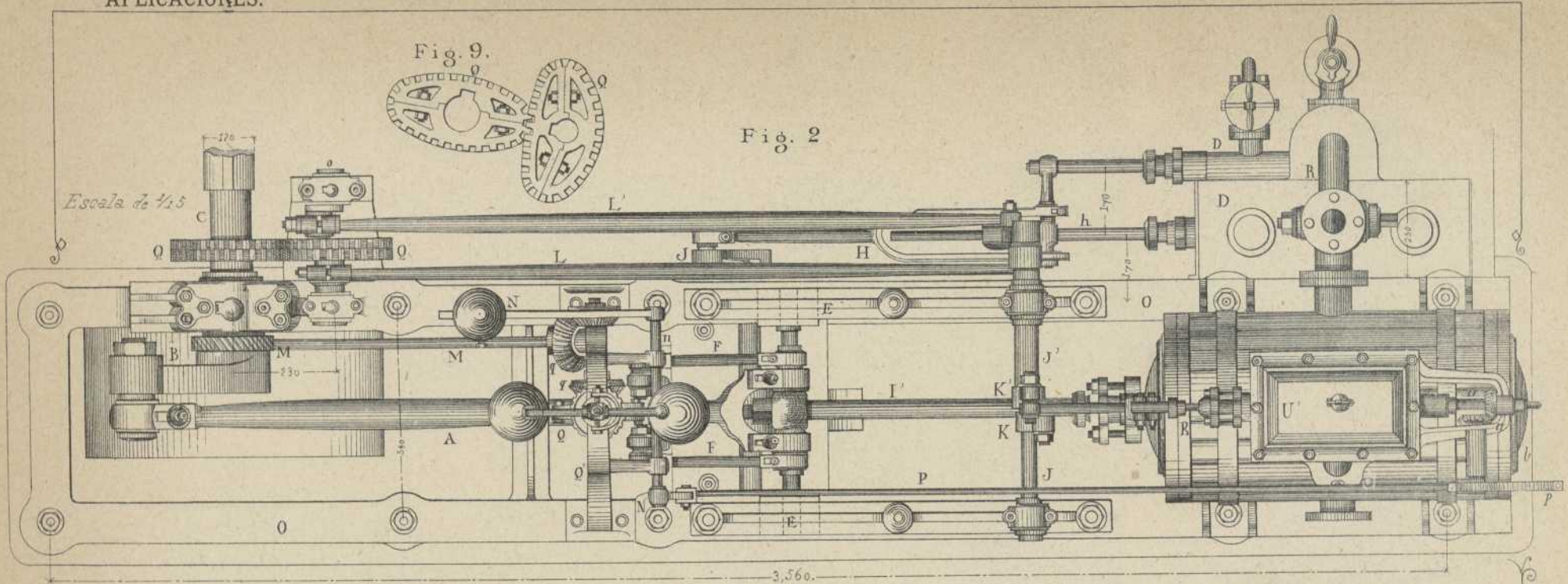


Fig. 1.

F.

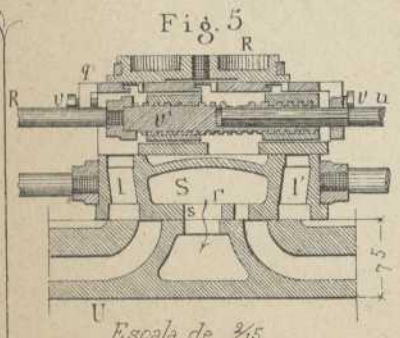
Nacenta, edito

Paseo de Gracia, 149.



Escala de 1/45

Fig. 2



Escala de 1/45

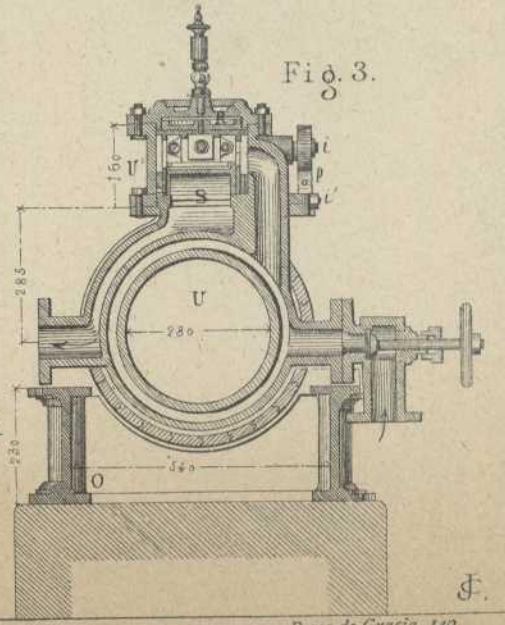
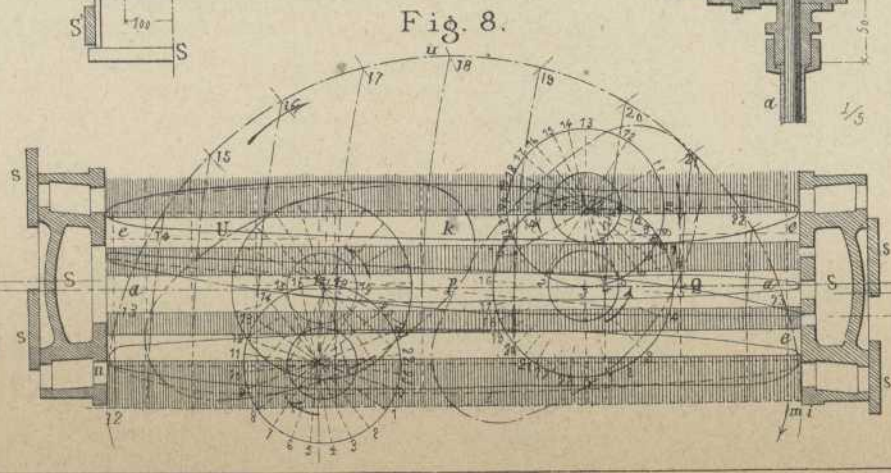
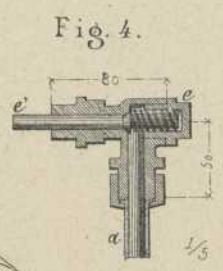
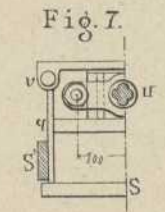
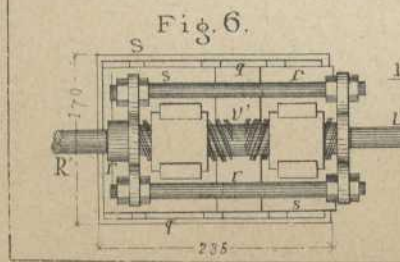


Fig. 1.

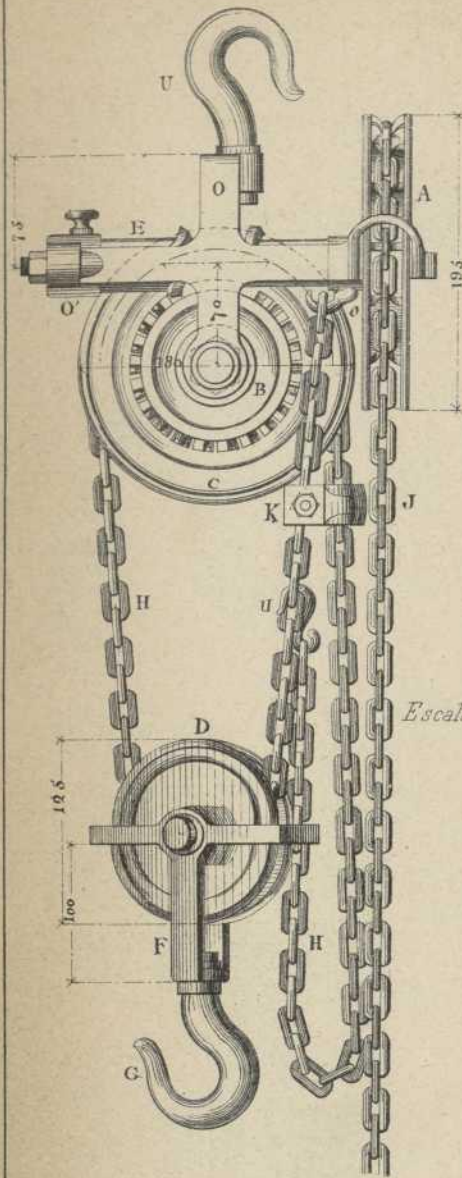


Fig. 2.

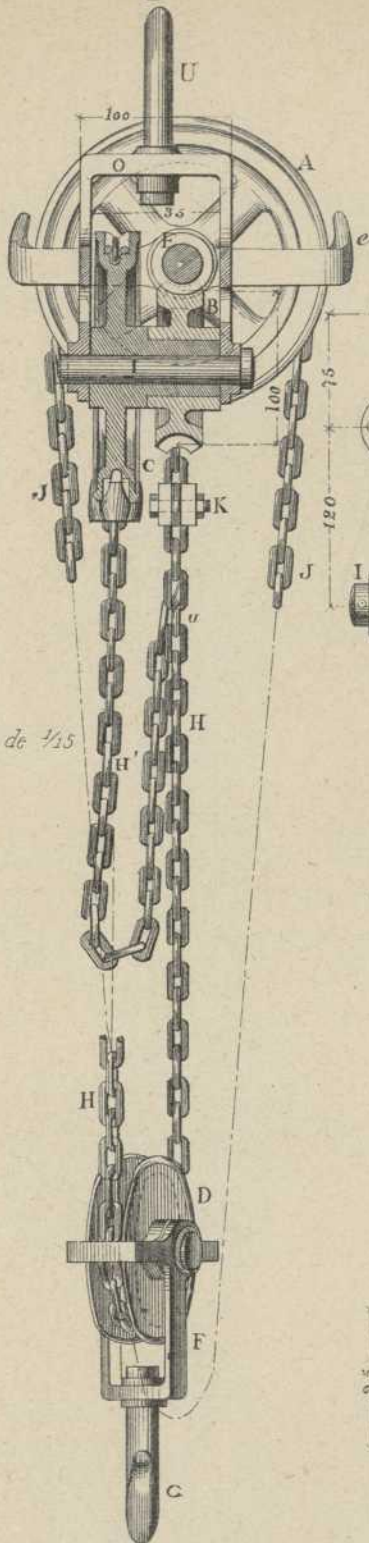
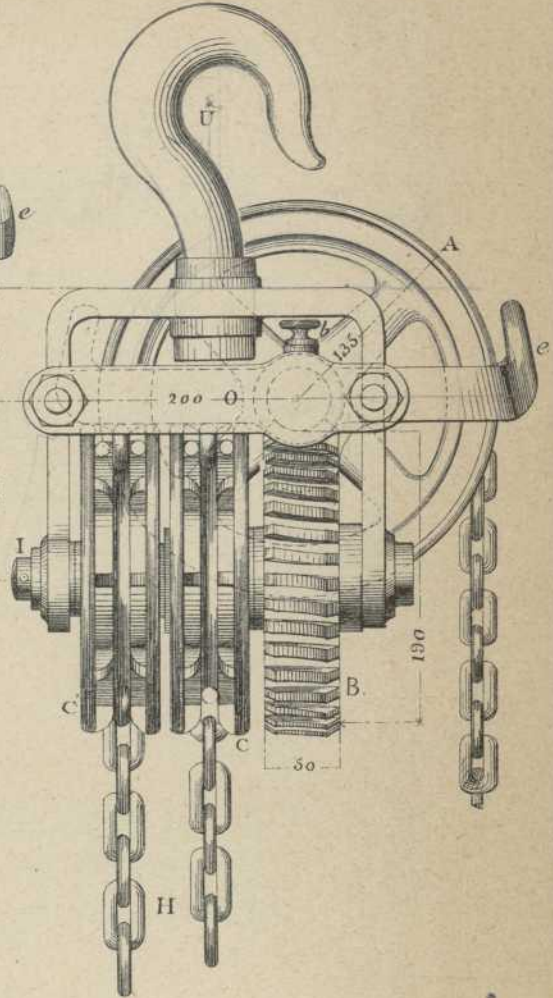


Fig. 5.



Escala de 1/15

Fig. 4.

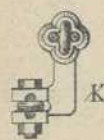
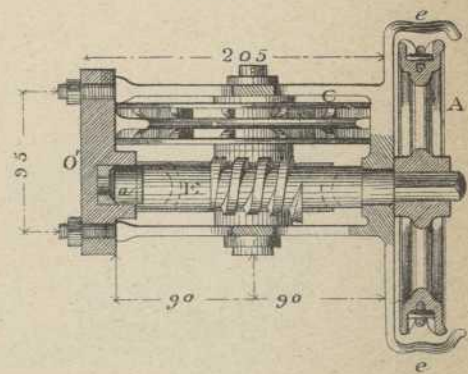
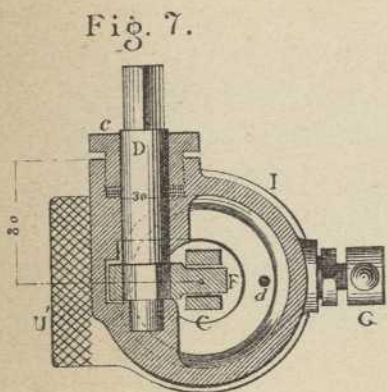
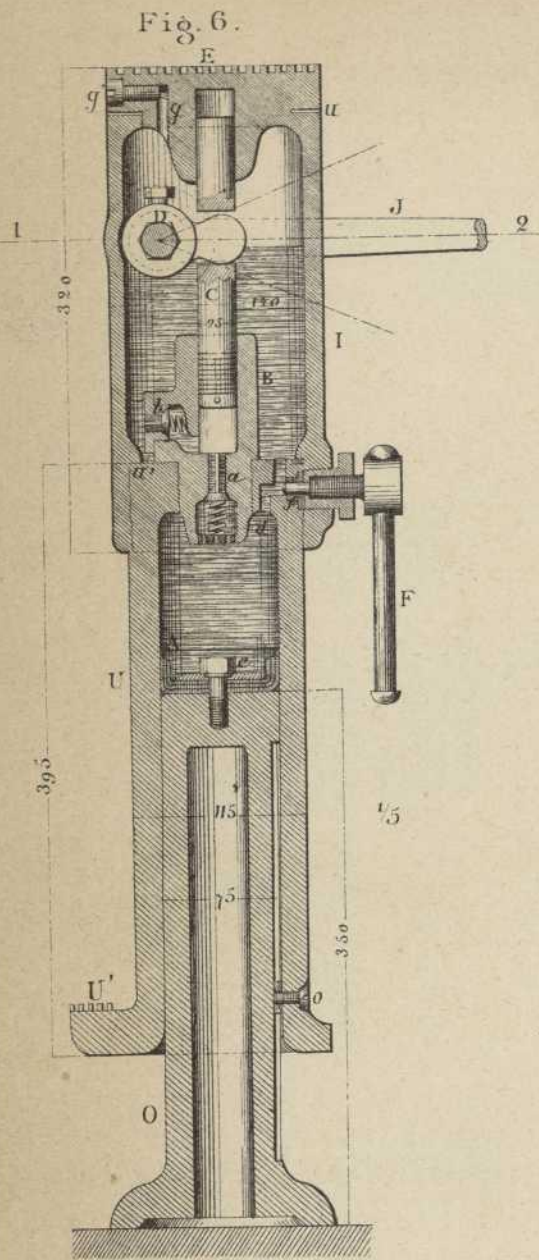


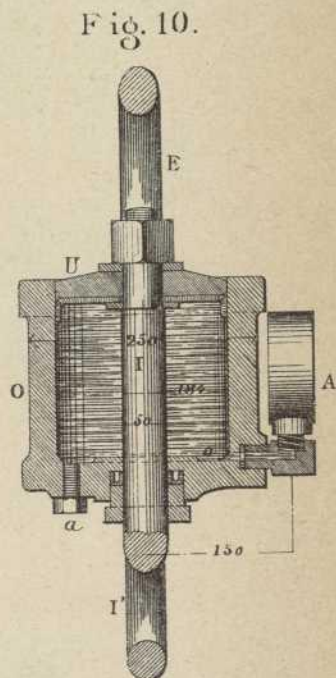
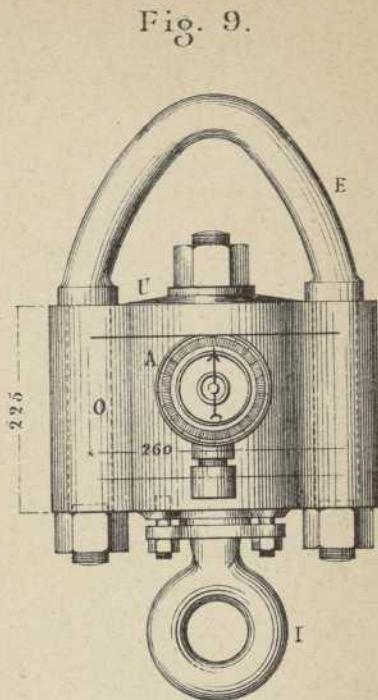
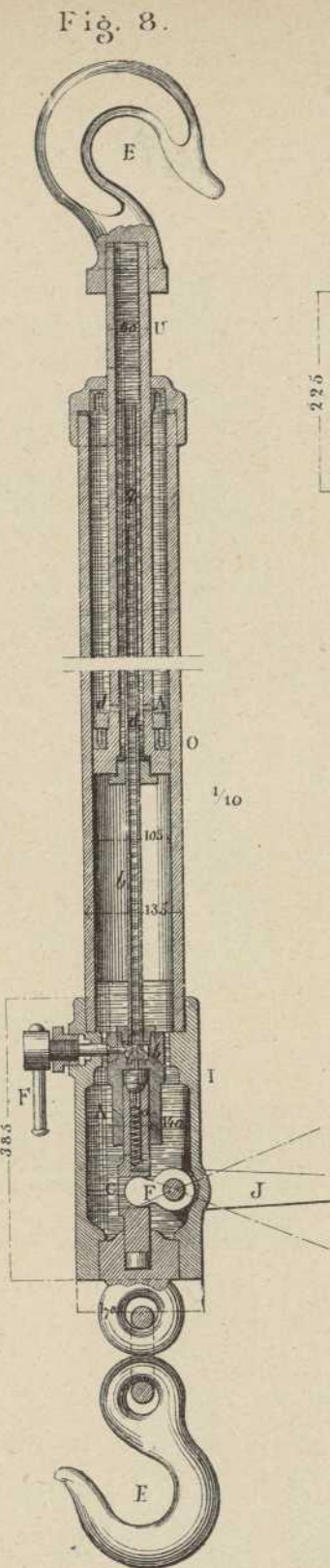
Fig. 3.

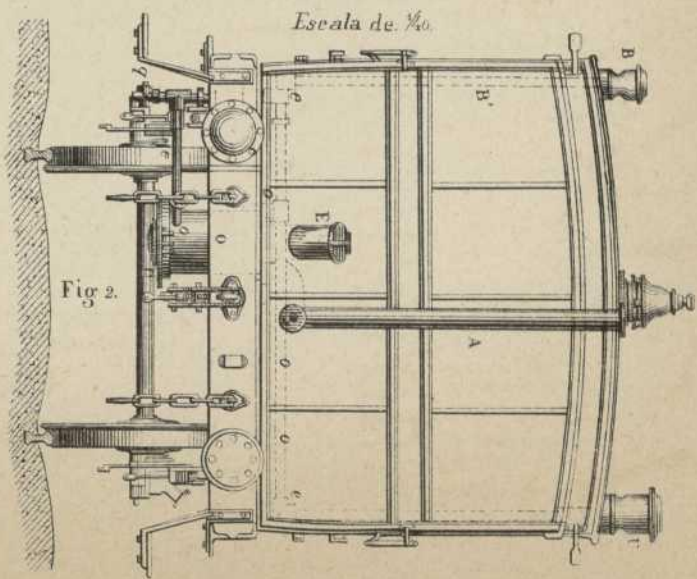
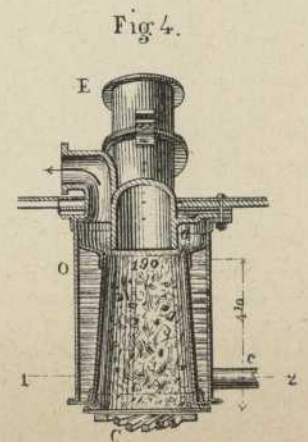
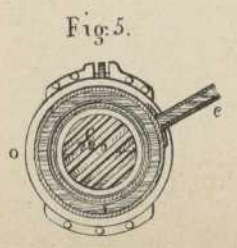
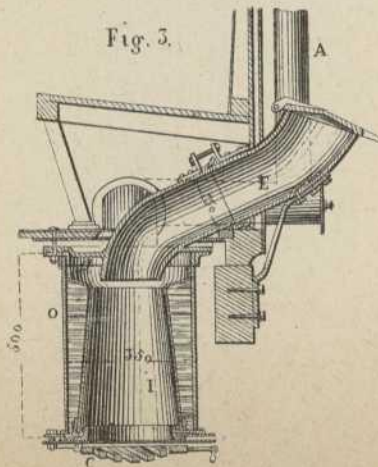
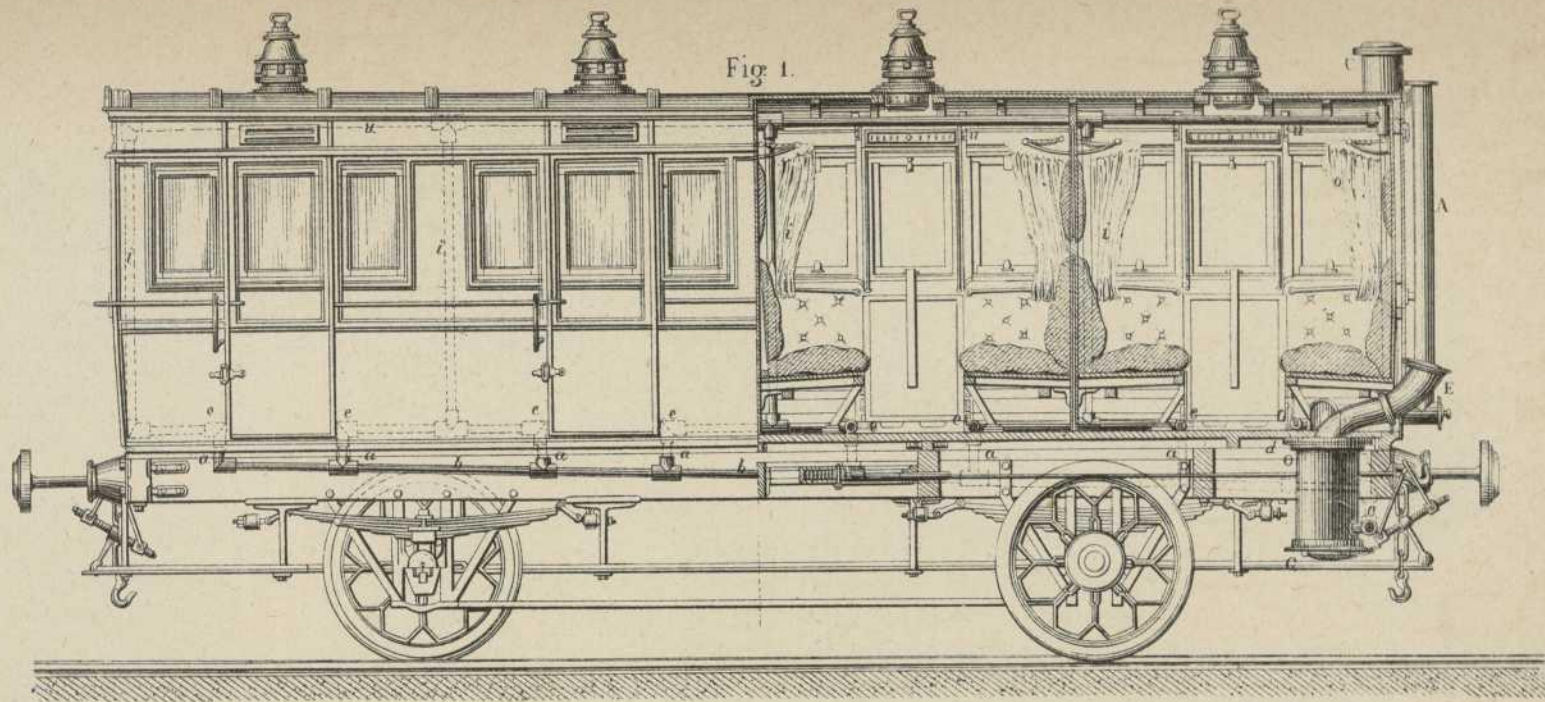


J.



Ⓕ





E.M.

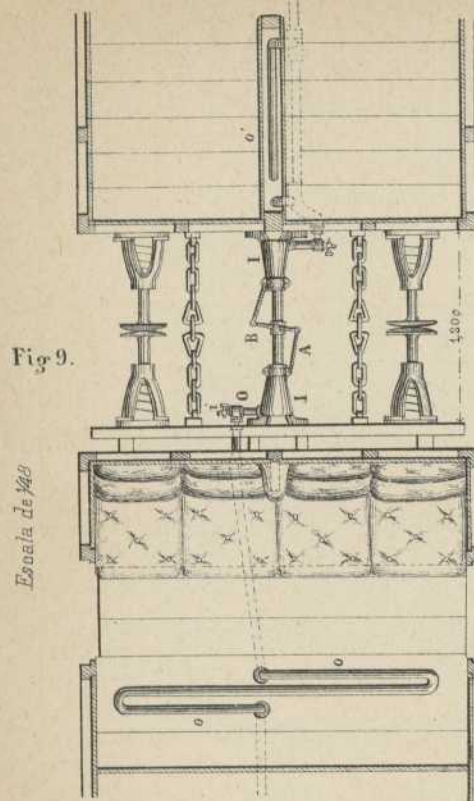


Fig. 9.

Escala de 1/48

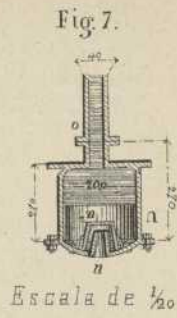


Fig. 7.

Escala de 1/20

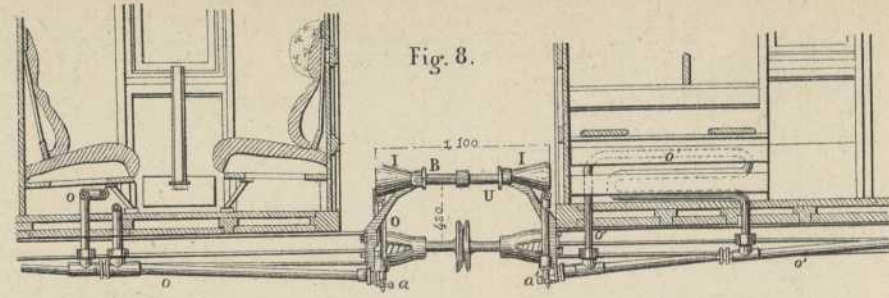


Fig. 8.

Fig. 6.

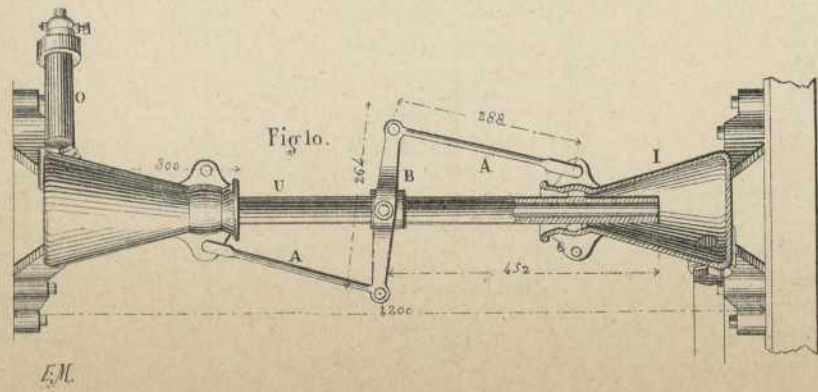
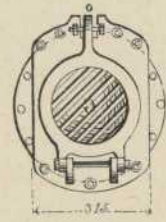


Fig. 10.

E.M.

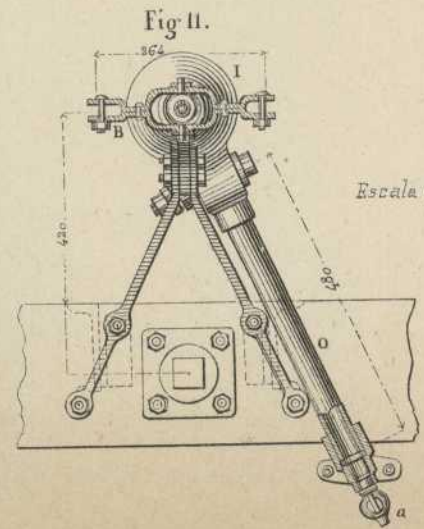


Fig. 11.

Escala de 1/20

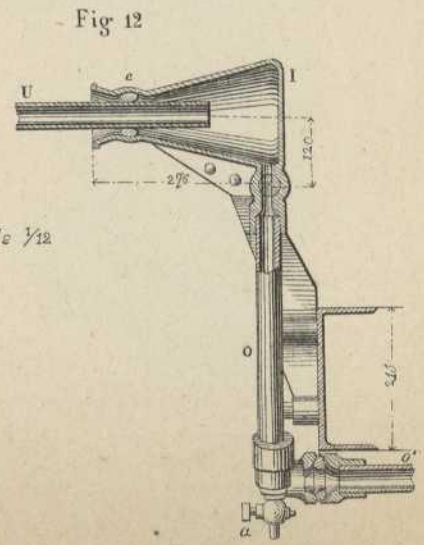
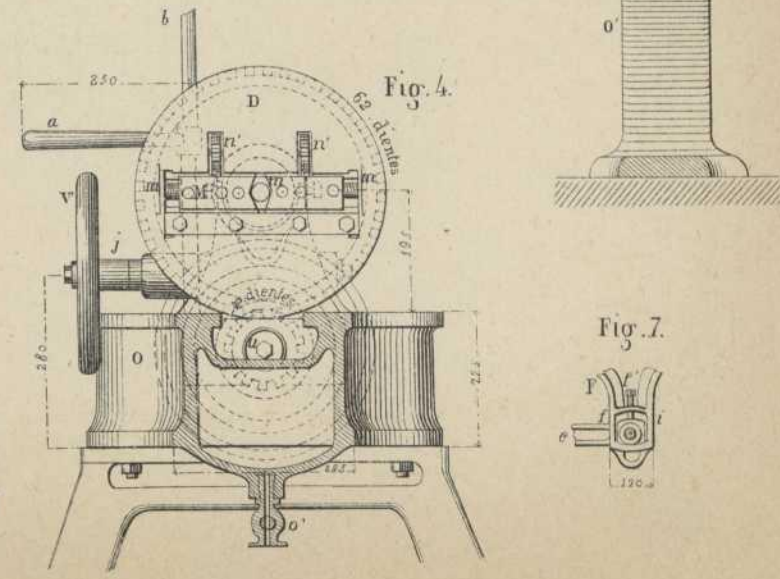
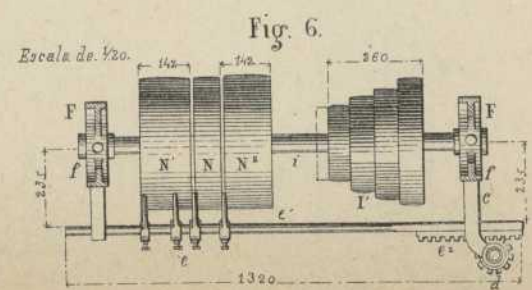
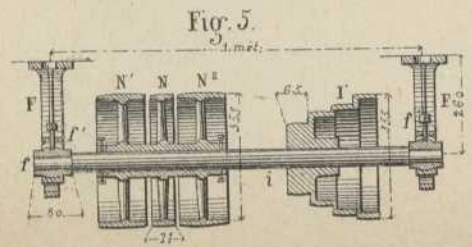
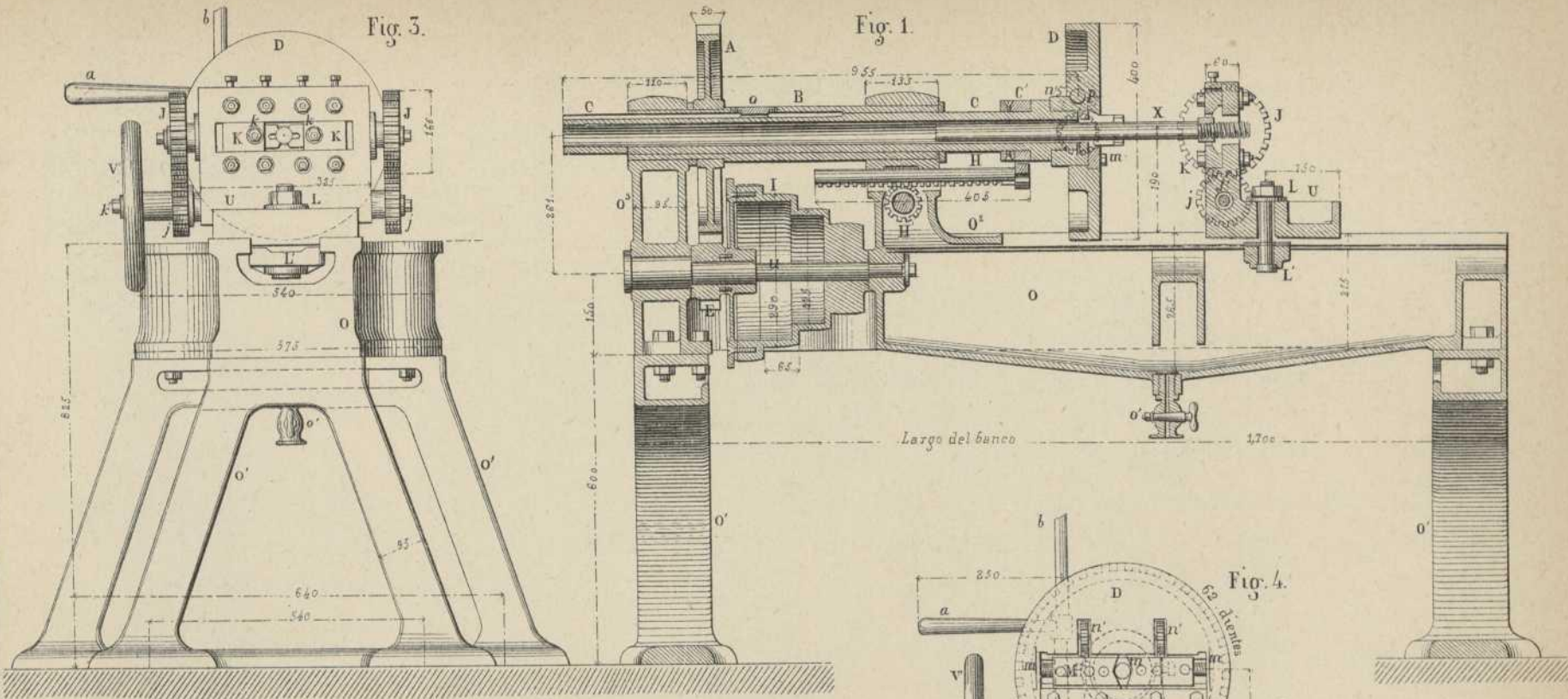


Fig. 12.



EM

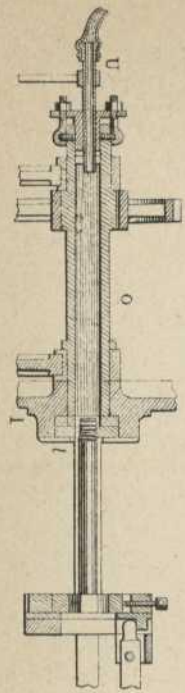


Fig. 15.

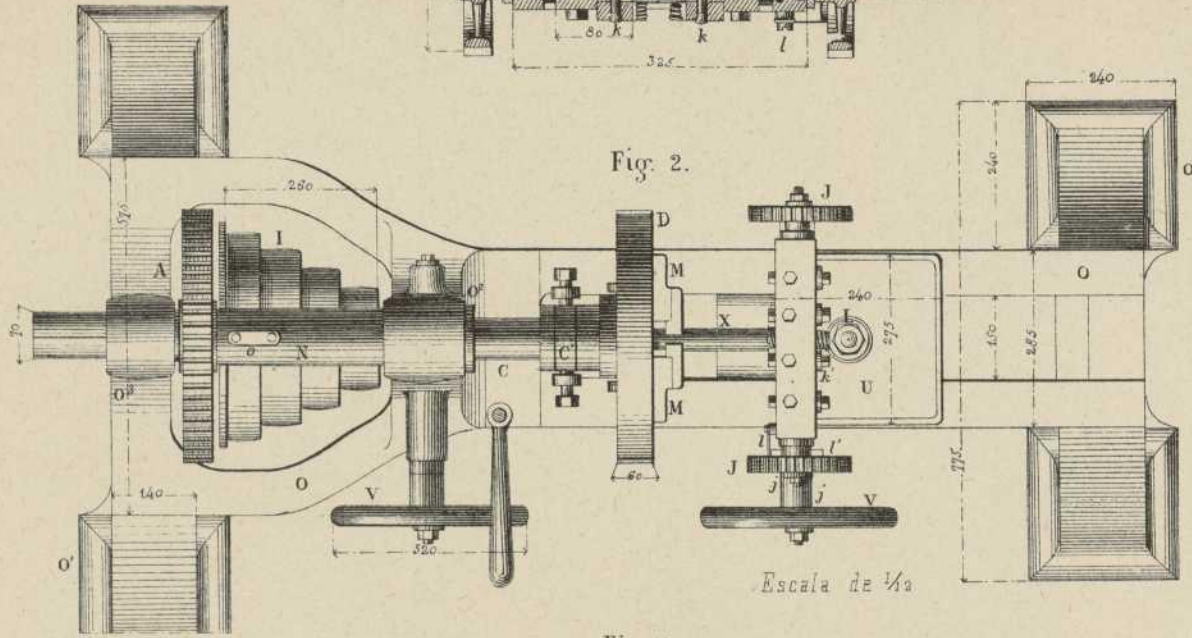


Fig. 2.

Escala de 1/4

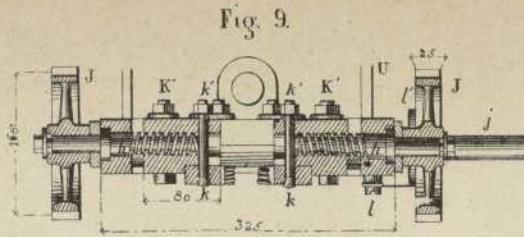


Fig. 9.

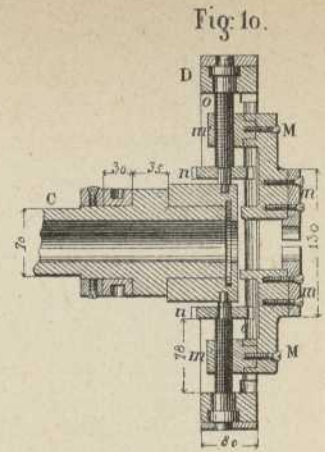


Fig. 10.

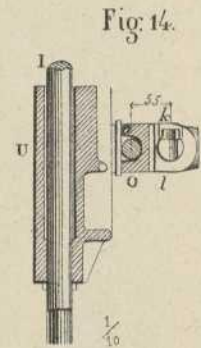


Fig. 14.

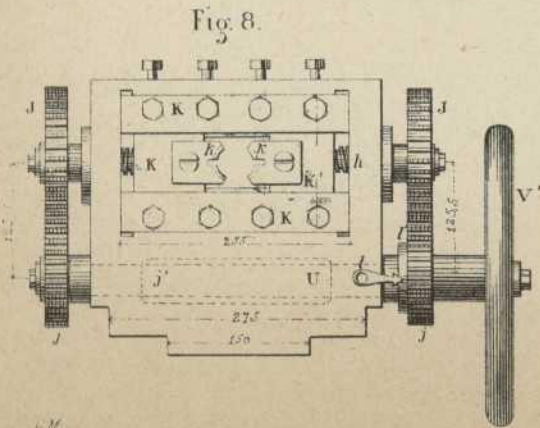


Fig. 8.

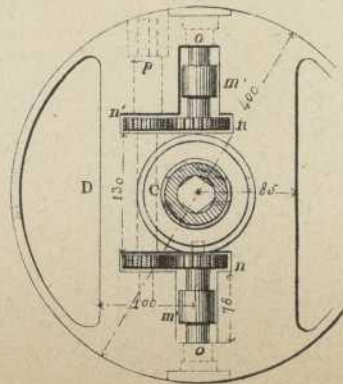


Fig. 11.

Escala de 1/6

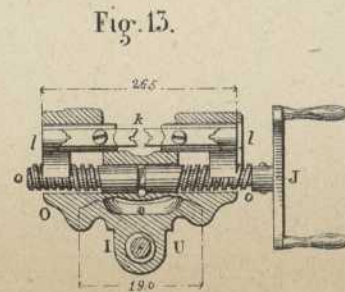


Fig. 13.

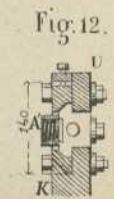


Fig. 12.

Fig. 1.



Fig. 2.

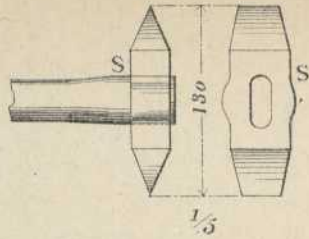


Fig. 3.

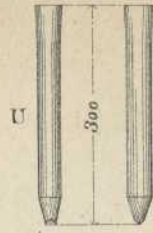


Fig. 4.

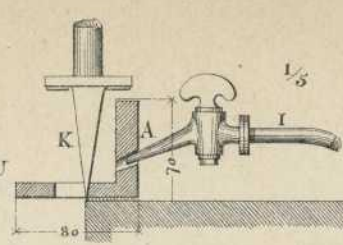


Fig. 25.

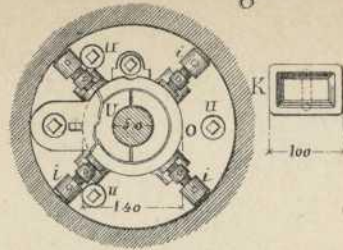


Fig. 14. Fig. 12. Fig. 11.

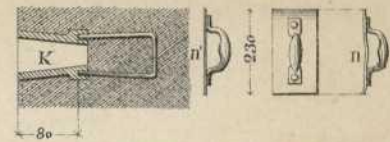


Fig. 26 Fig. 27.

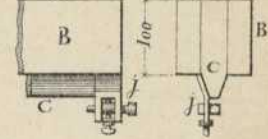


Fig. 19.

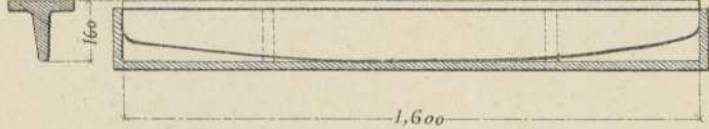


Fig. 18.



Fig. 17.

Fig. 5.

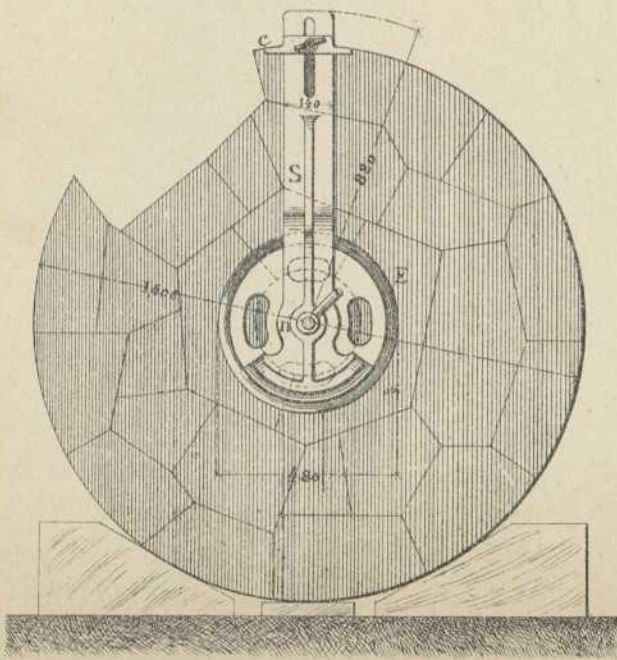


Fig. 6.

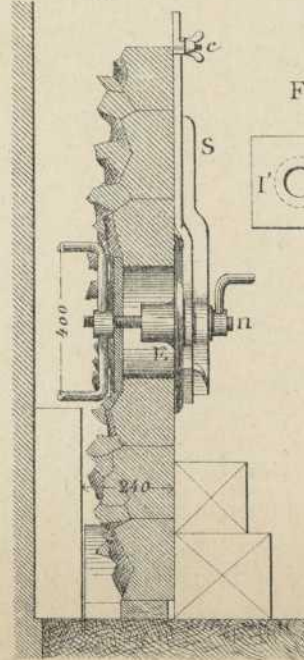


Fig. 7.

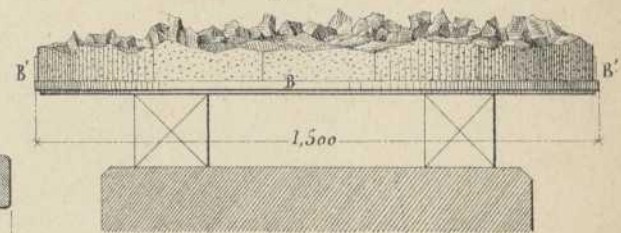


Fig. 15.

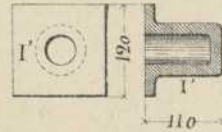


Fig. 8.

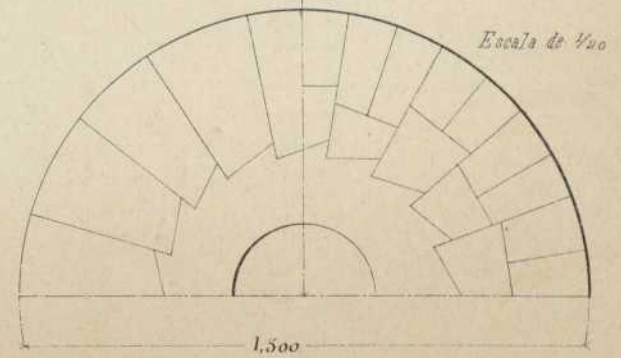


Fig. 9.

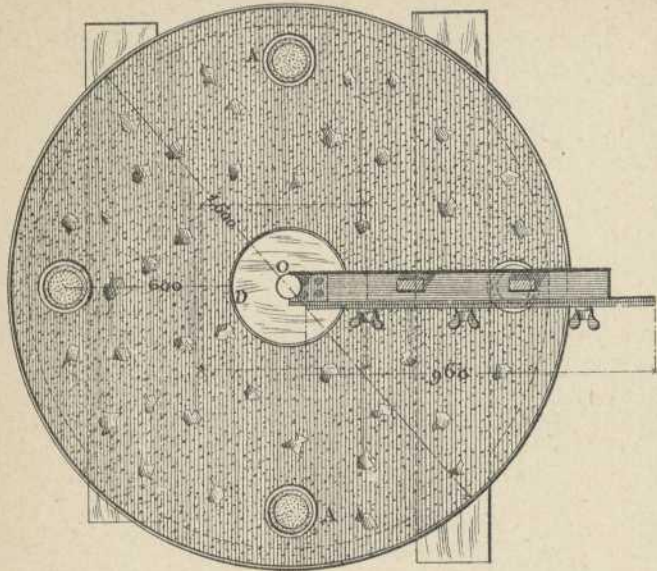


Fig. 16

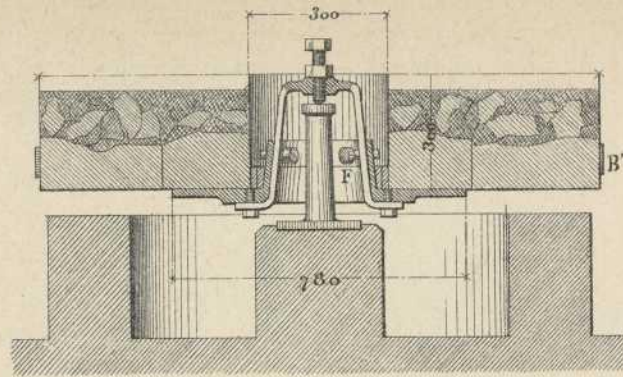


Fig. 24.

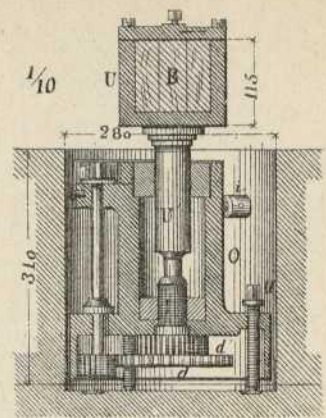


Fig. 21.

Fig. 20.

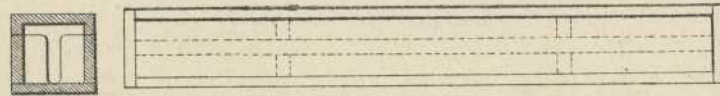


Fig. 13.

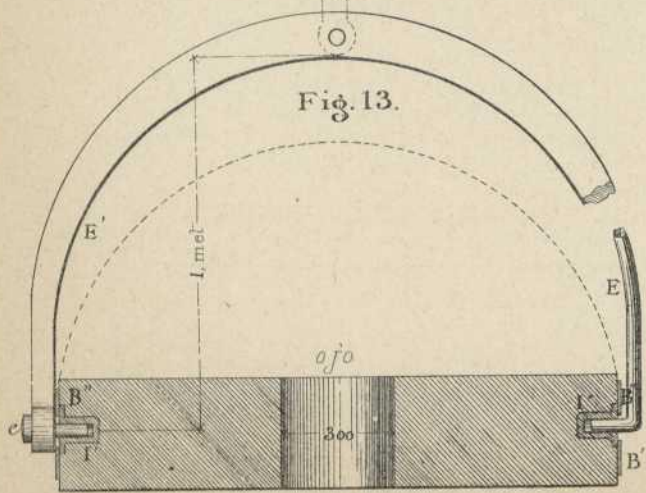


Fig. 10.

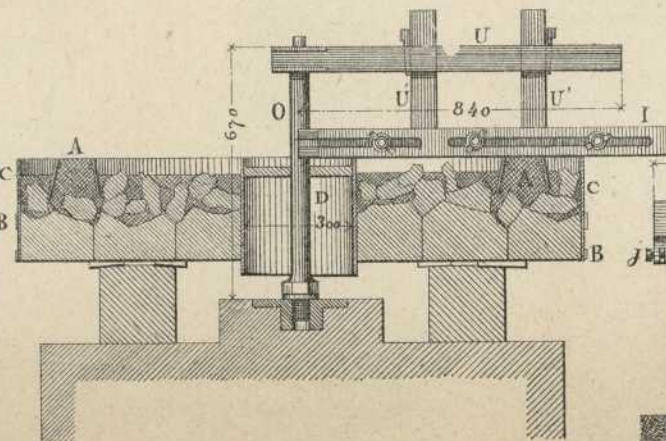


Fig. 23.

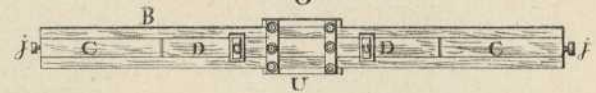
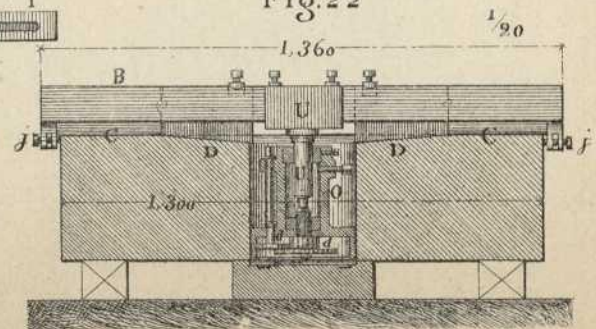
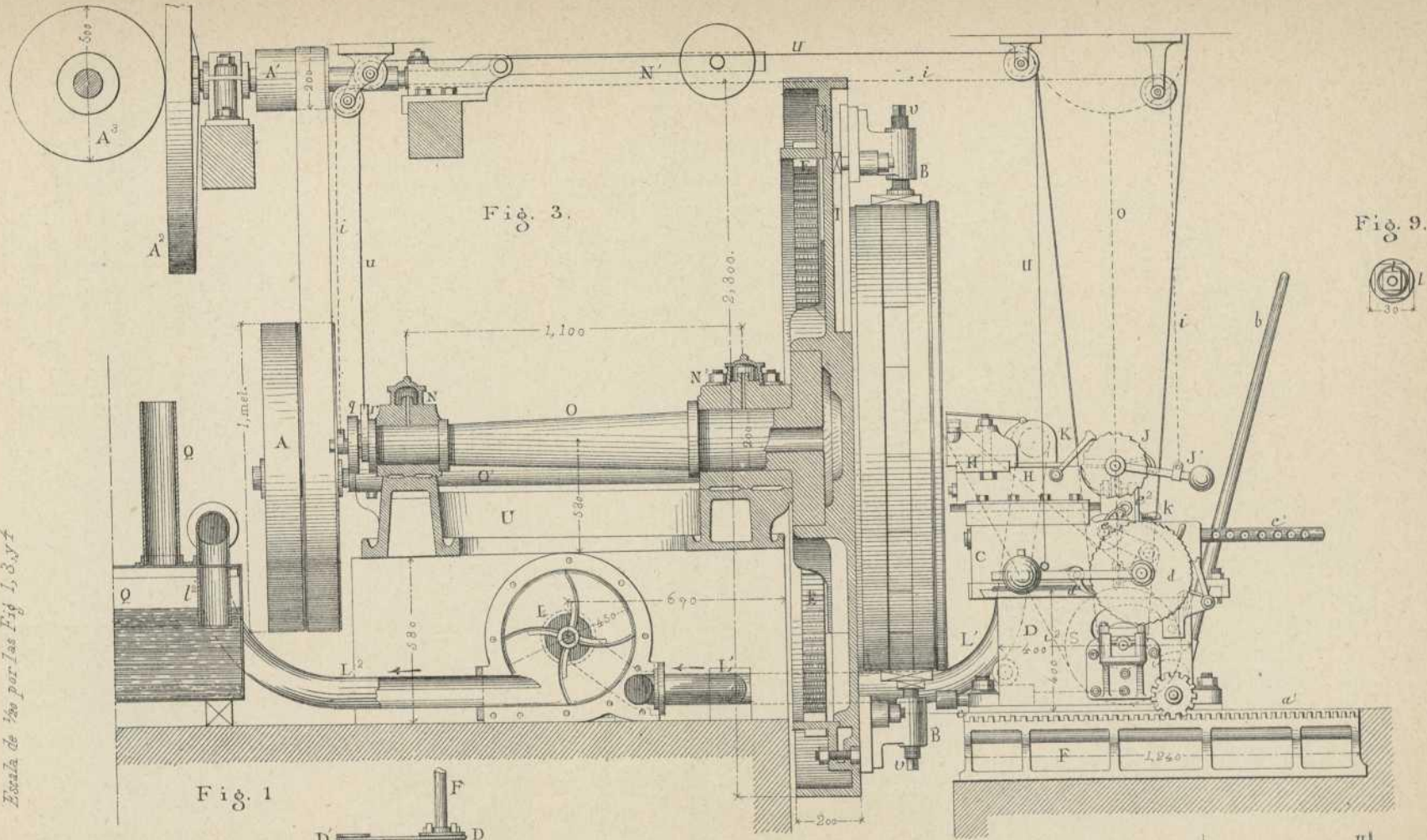


Fig. 22



Ⓕ



Escala de 1/50 por las Fig. 1, 3, y 4

Fig. 1

Fig. 3.

Fig. 9.

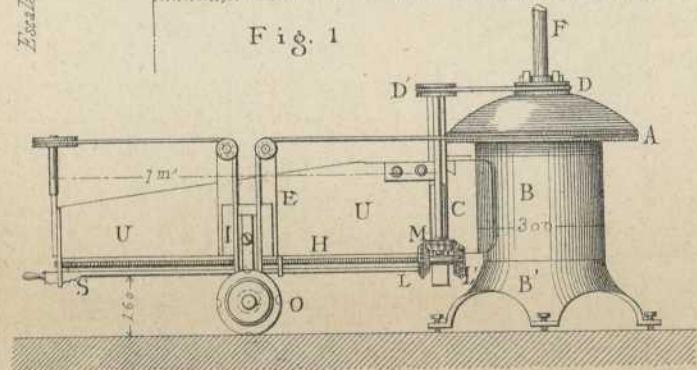


Fig. 8.

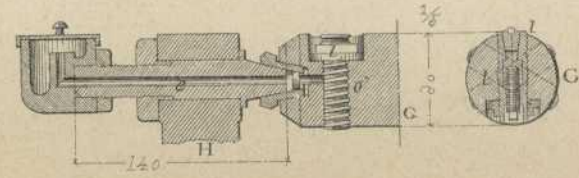


Fig. 10.

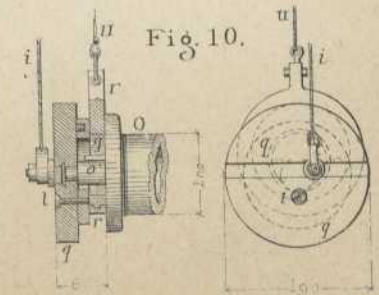


Fig. 4.

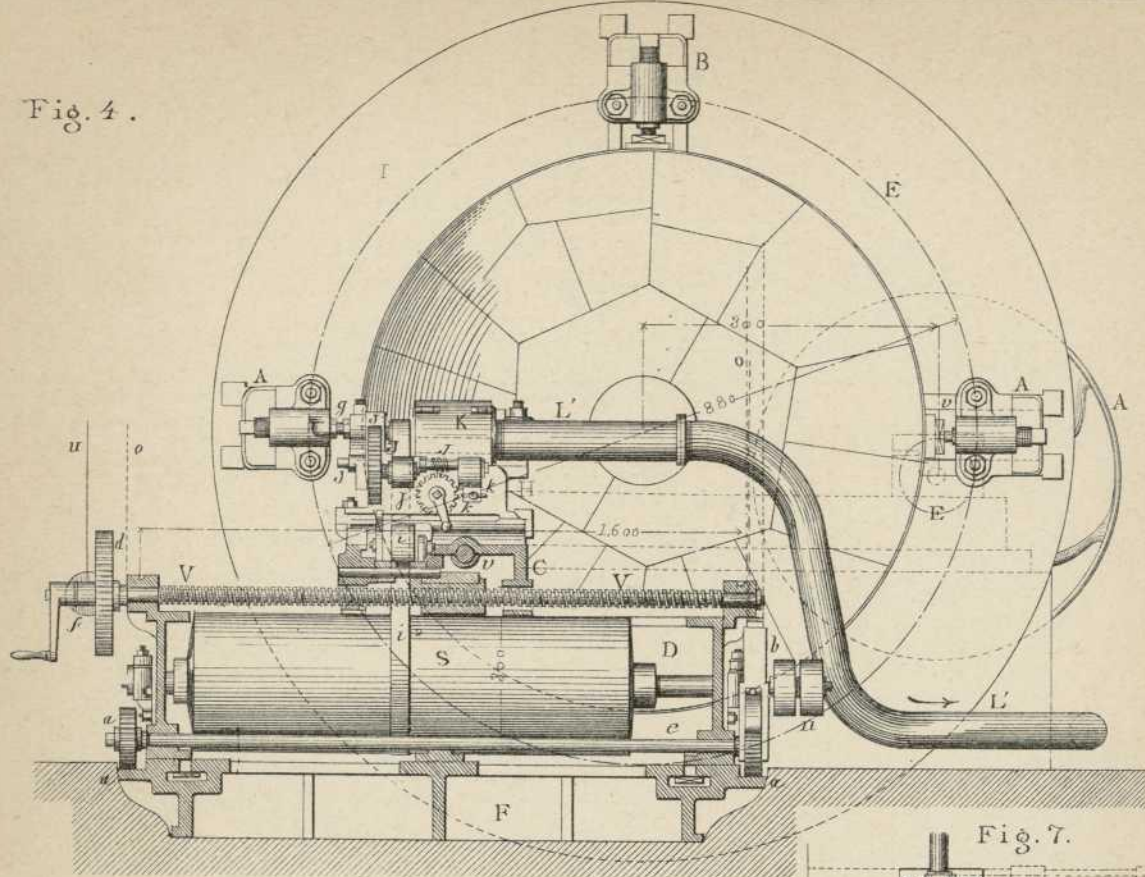


Fig. 6.

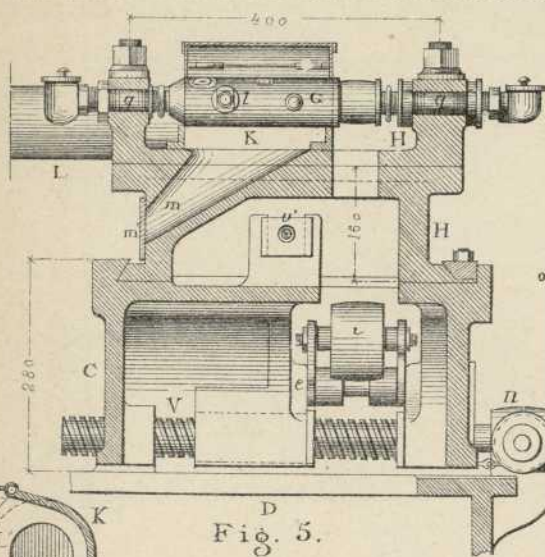


Fig. 5.

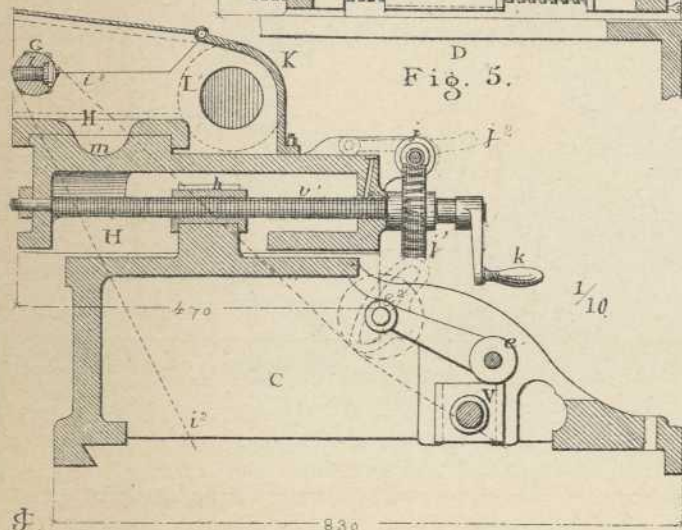


Fig. 7.

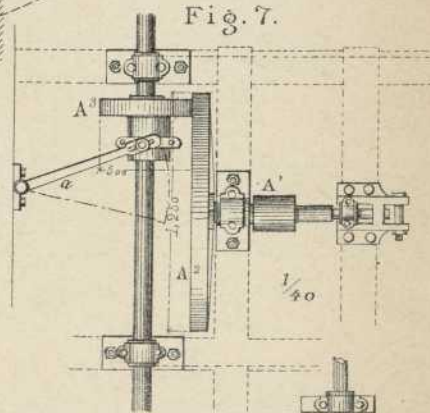


Fig. 2.

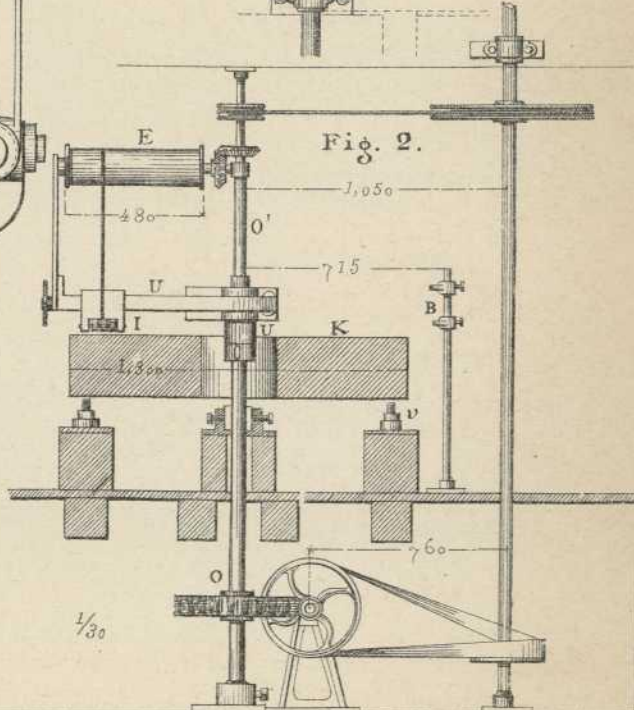
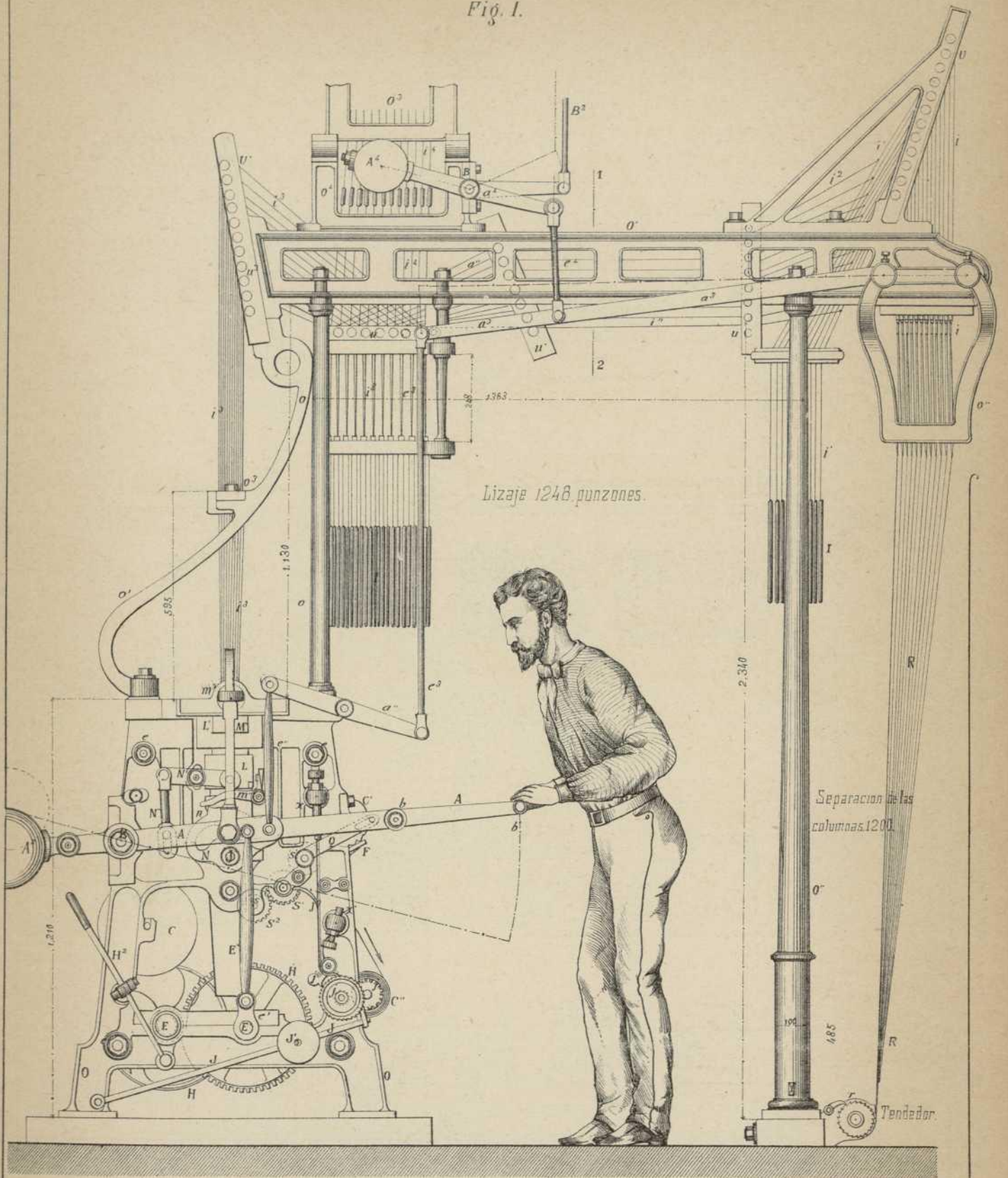


Fig. 1.



Lizaje 1248 punzones.

Separacion de las columnas 1200.

Tenedor.

Escala de 1/15

Fig. 2.

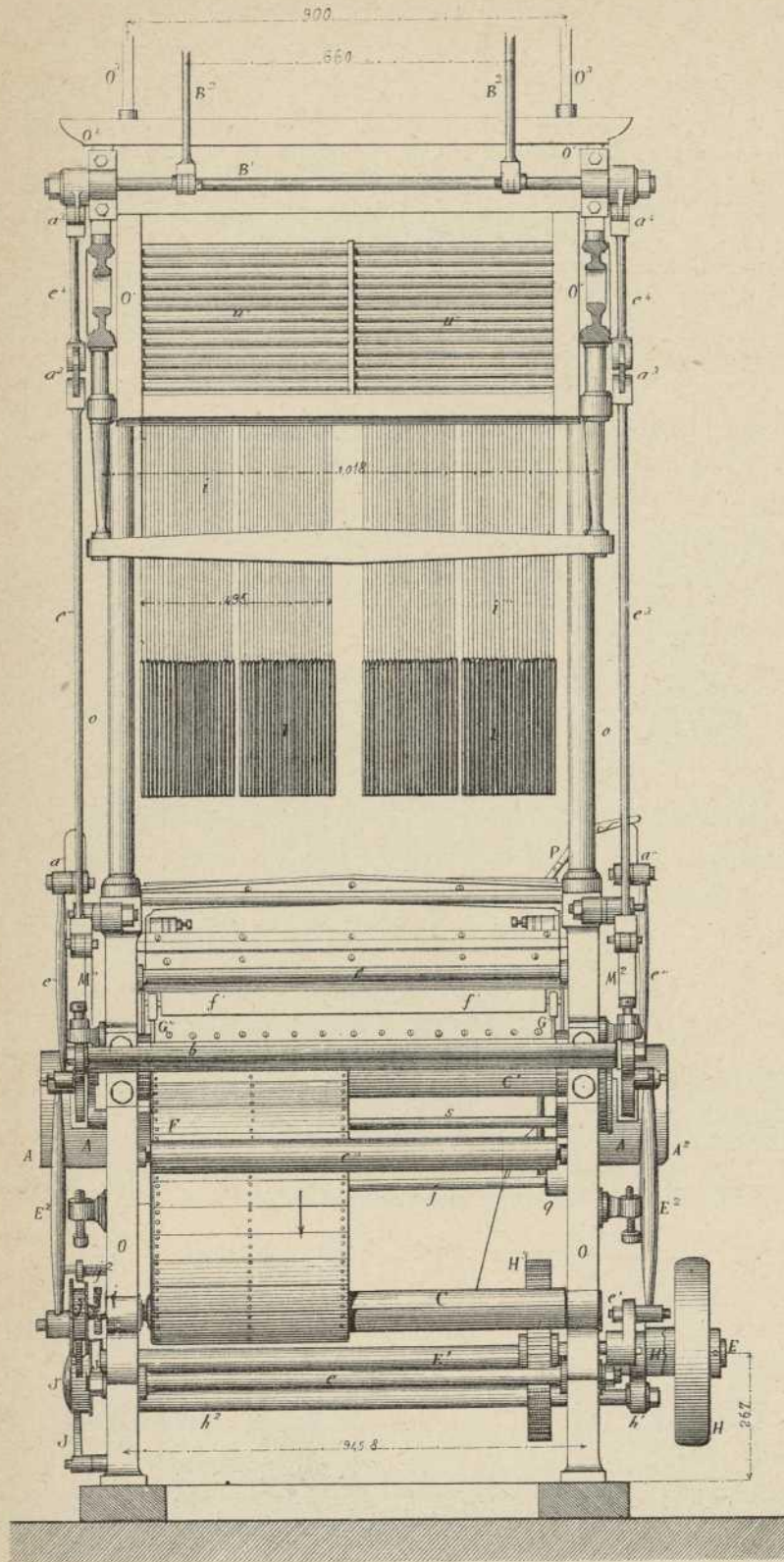


Fig. 13.

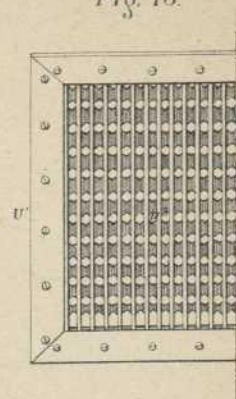


Fig. 14.

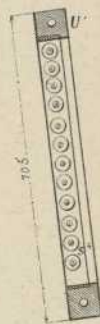
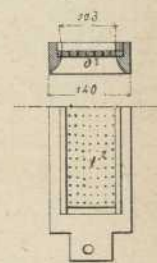
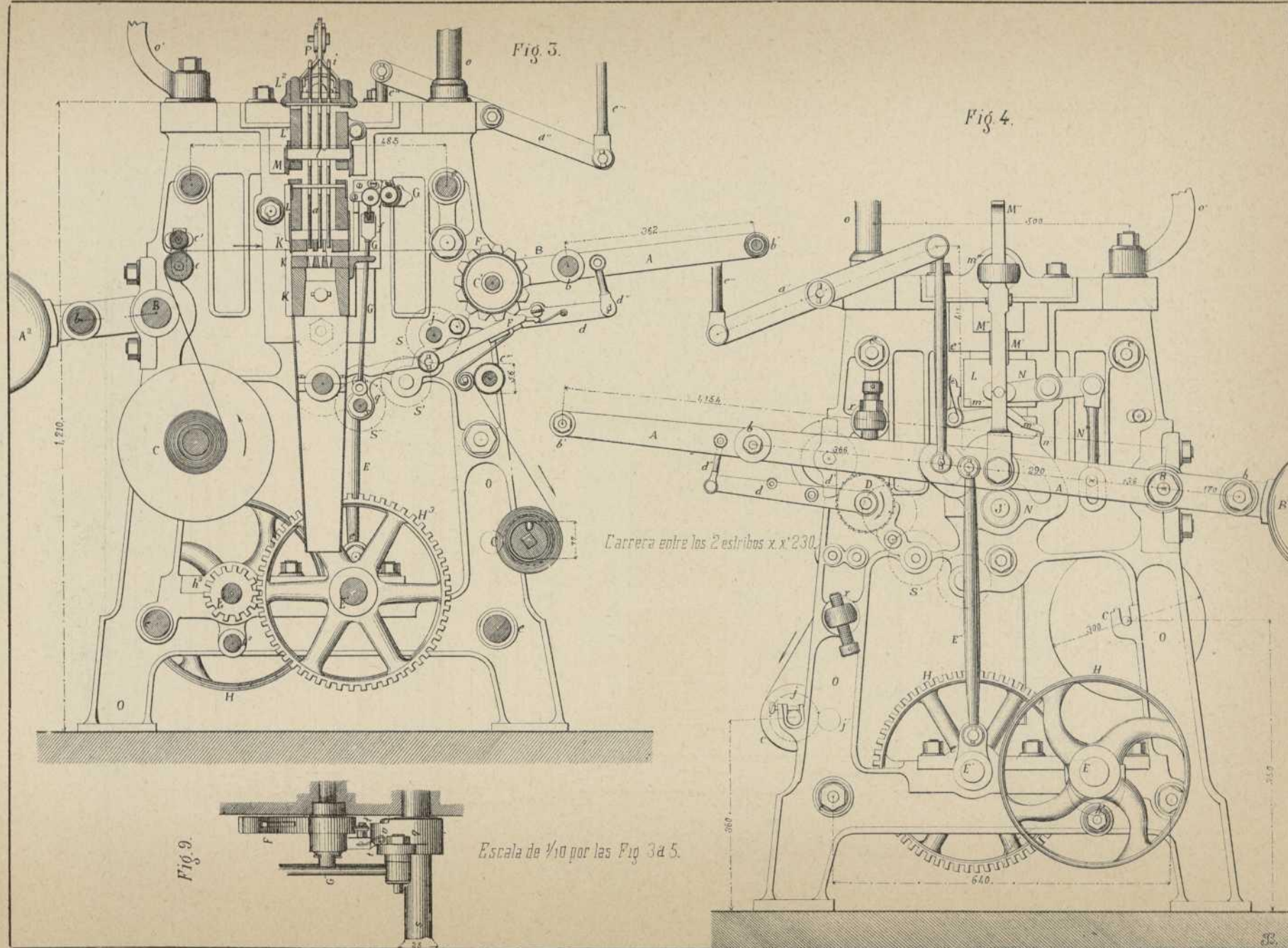


Fig. 15.



Escala de 1/15



Carrera de los punzones. 15 mil.

Fig. 7.

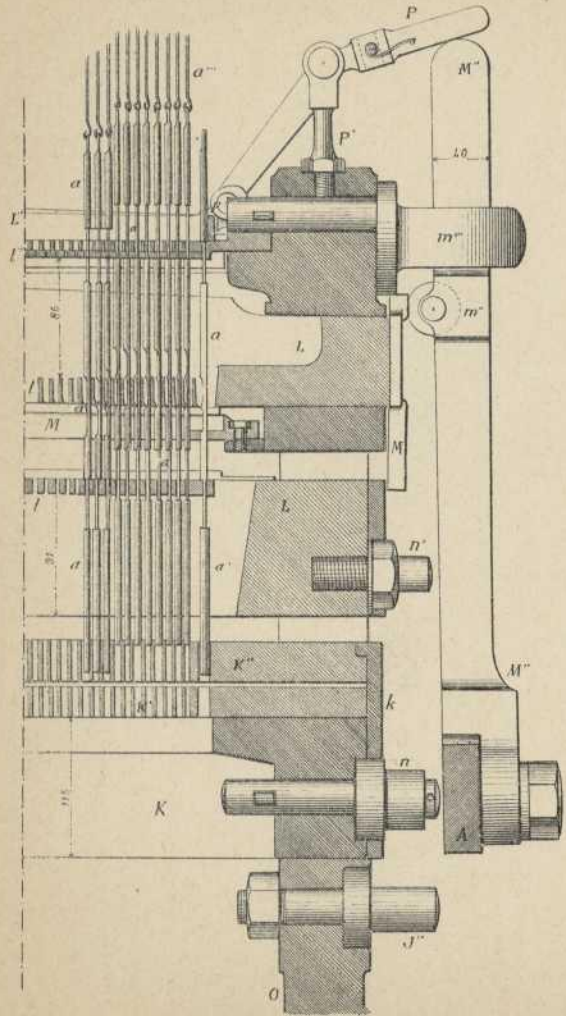
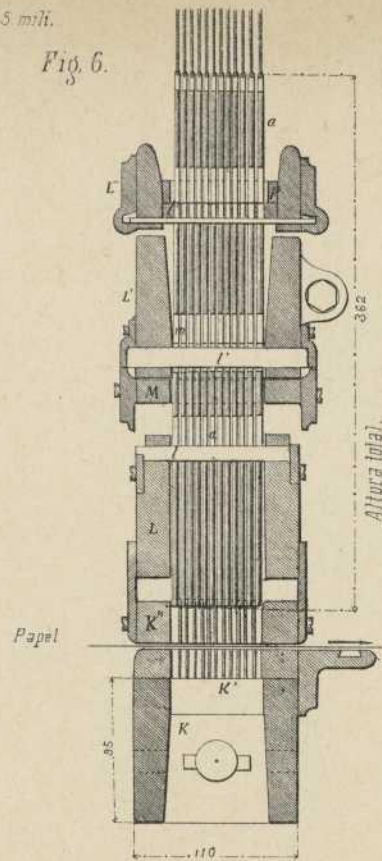


Fig. 6.



Altura total.

Papel

Fig. 5.

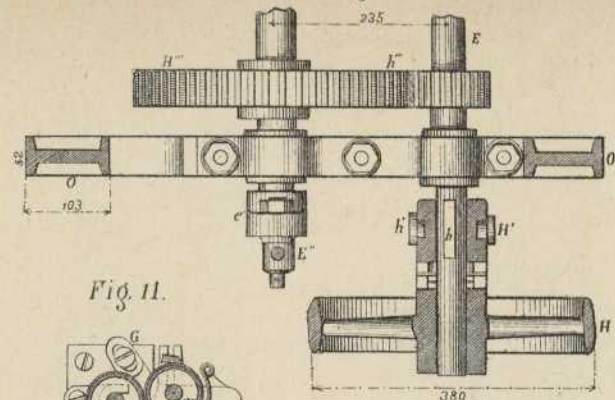
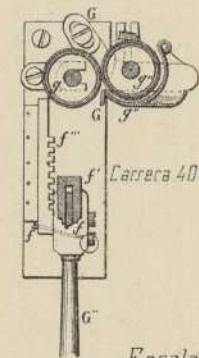


Fig. 11.



Carrera 40 mil.

Escala de 1/10 por las Fig. 3a5

Fig. 10.

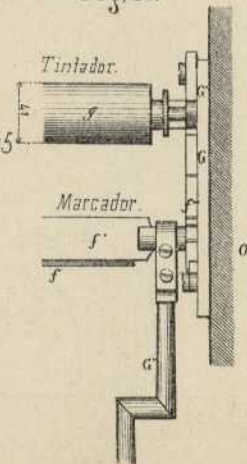


Fig. 8.

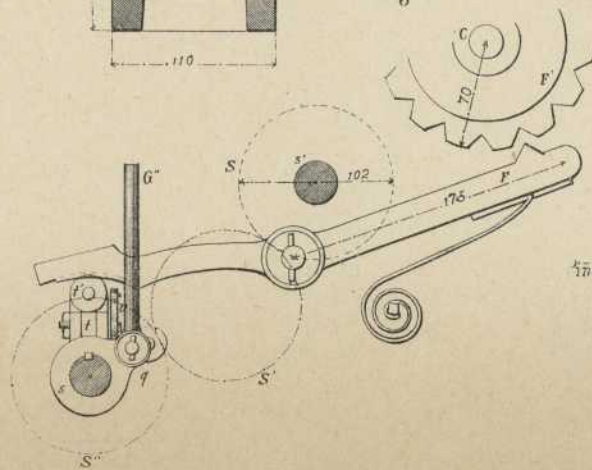
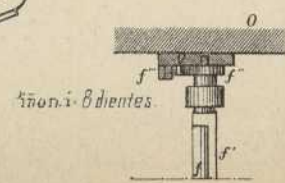


Fig. 12.



Escala de 1/4 por las Fig. 6 a 12

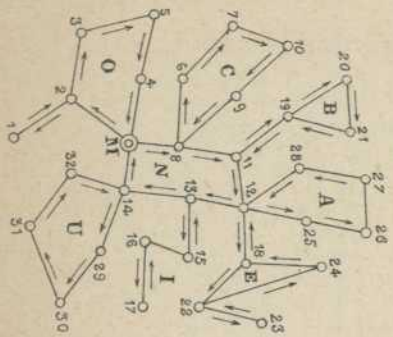


Fig. 1.

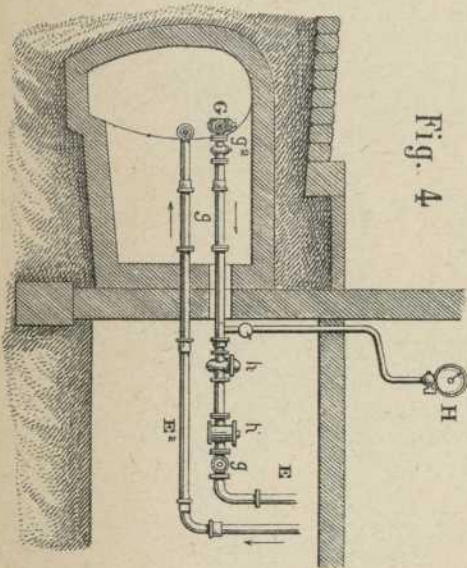


Fig. 4.

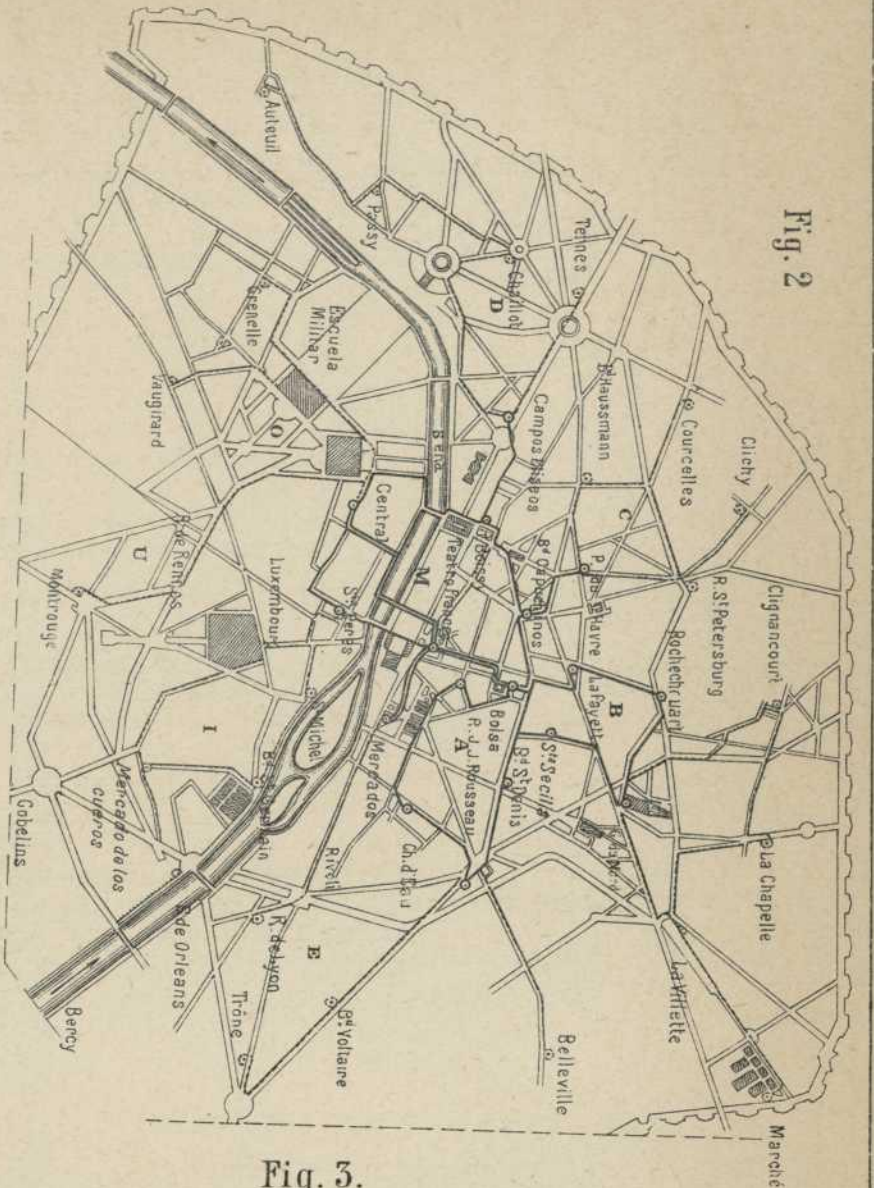
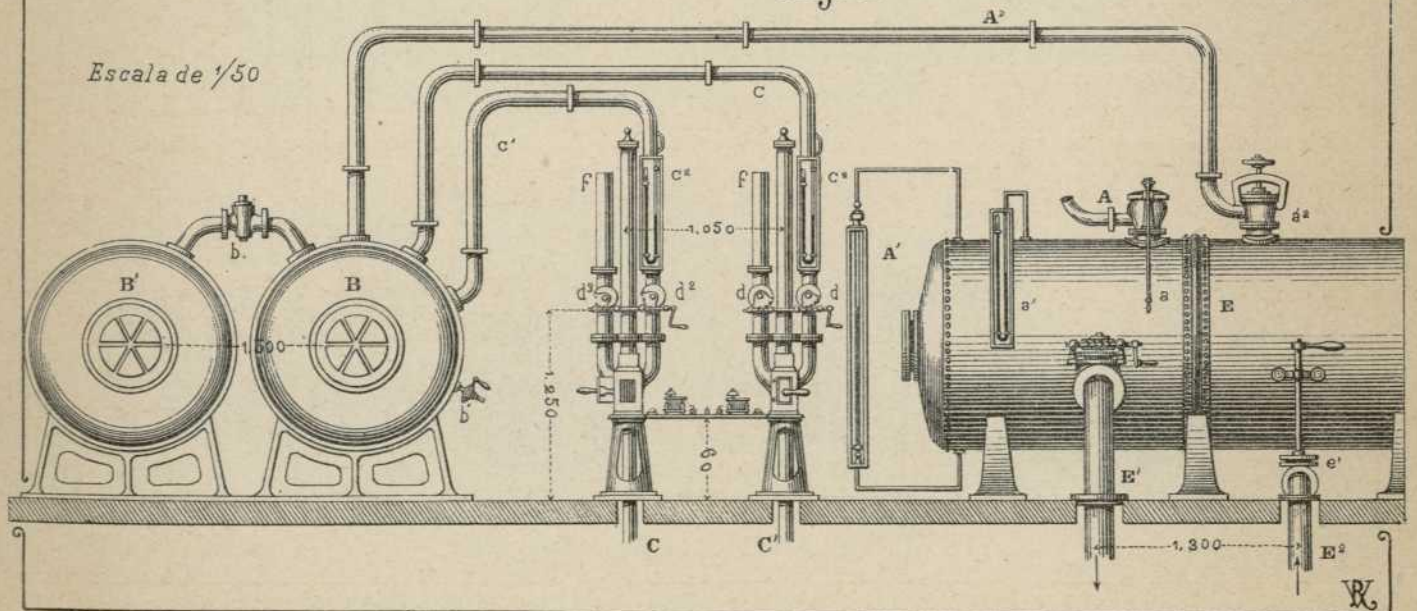


Fig. 2.

Fig. 3.



Escala de 1/50

Fig. 8

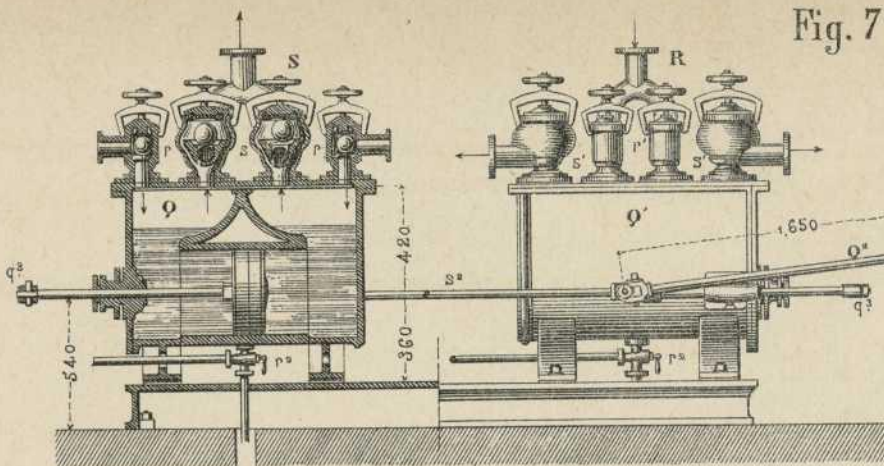
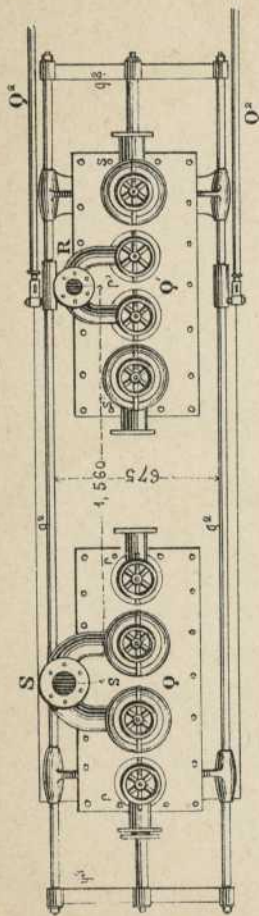


Fig. 7

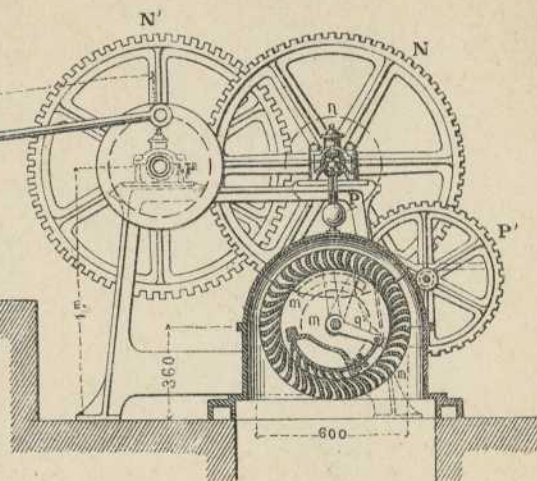


Fig. 5

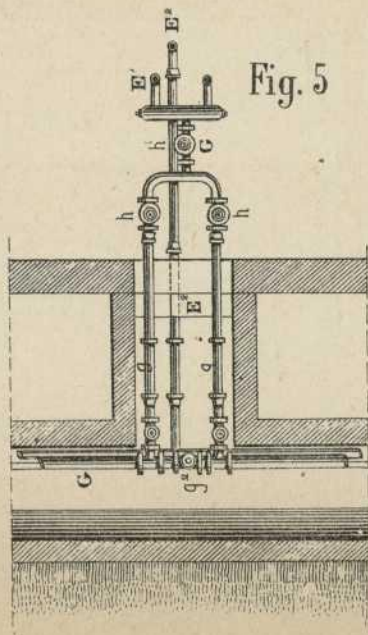


Fig. 9

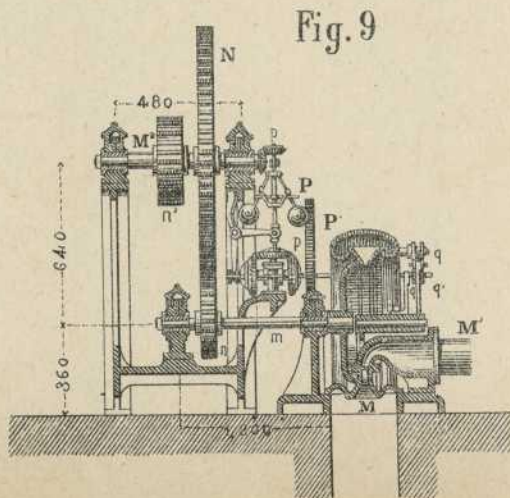
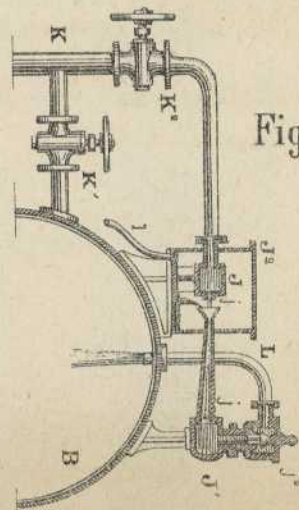
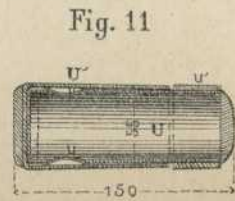
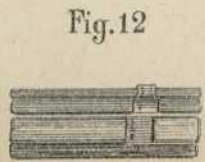
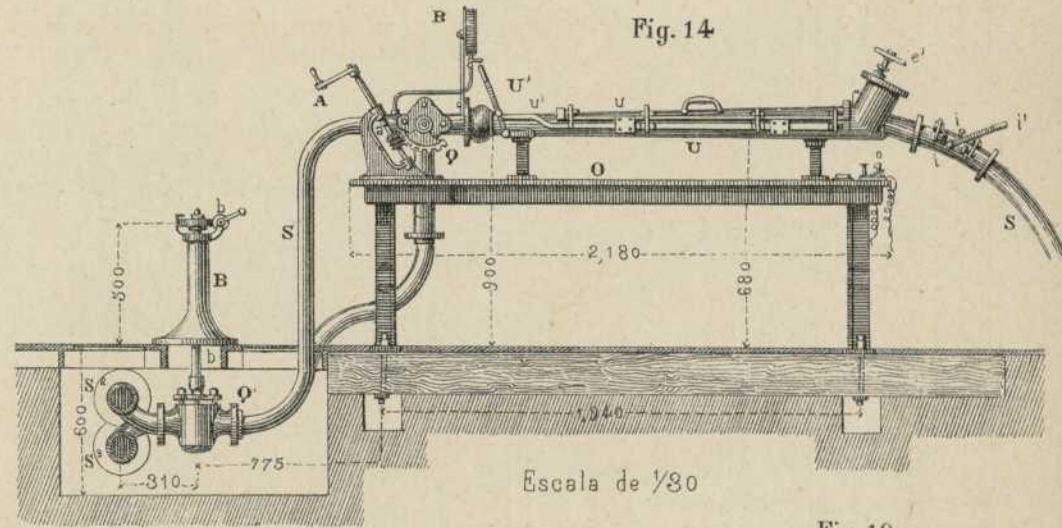
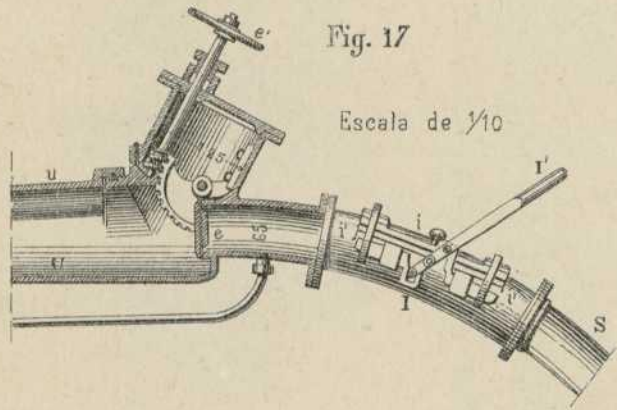
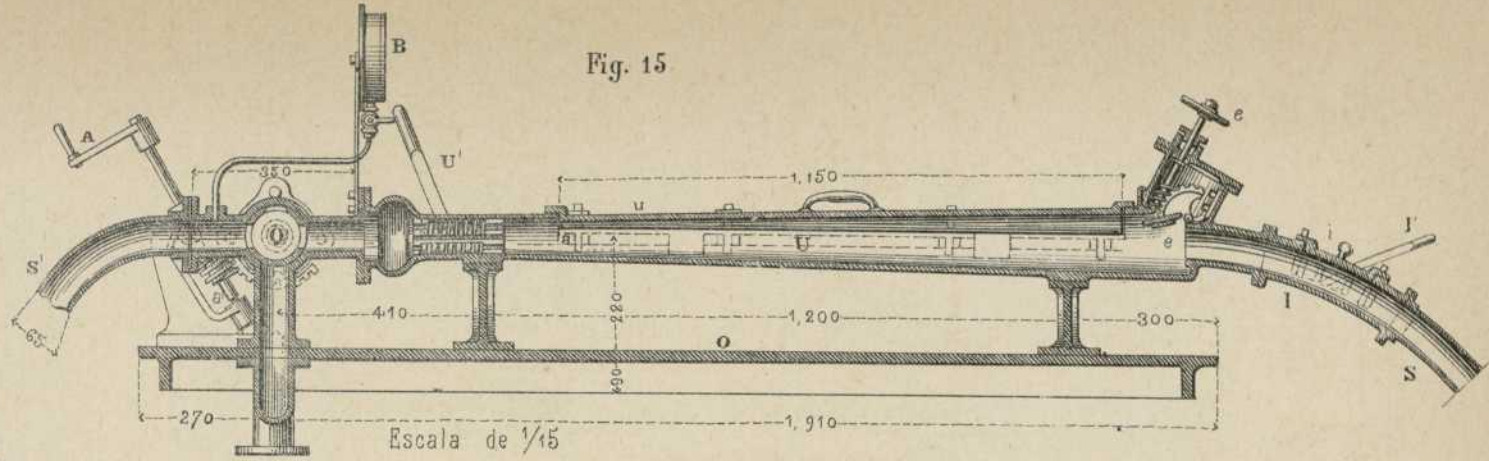
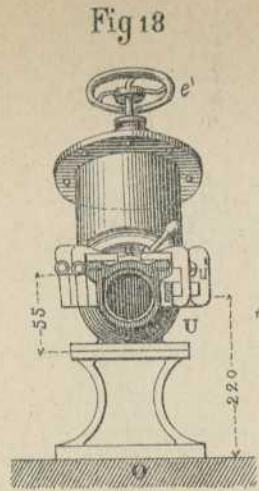


Fig. 6

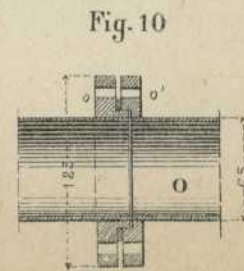
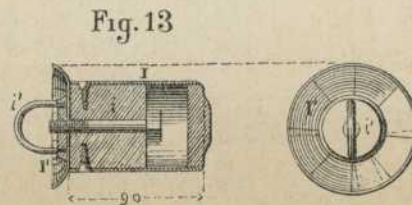


Escala de 1/30 por las Fig. 7 à 9.

W



Escala de 1/5



R

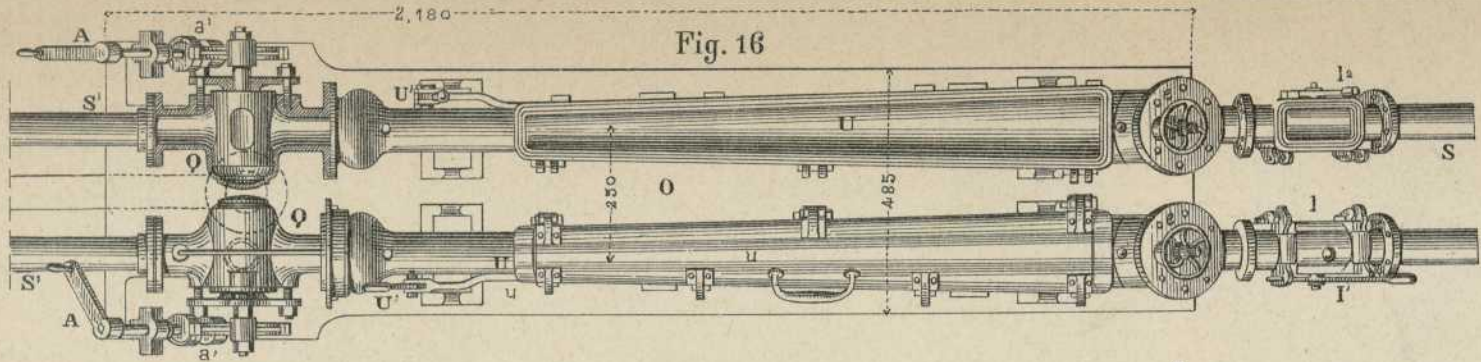


Fig. 16

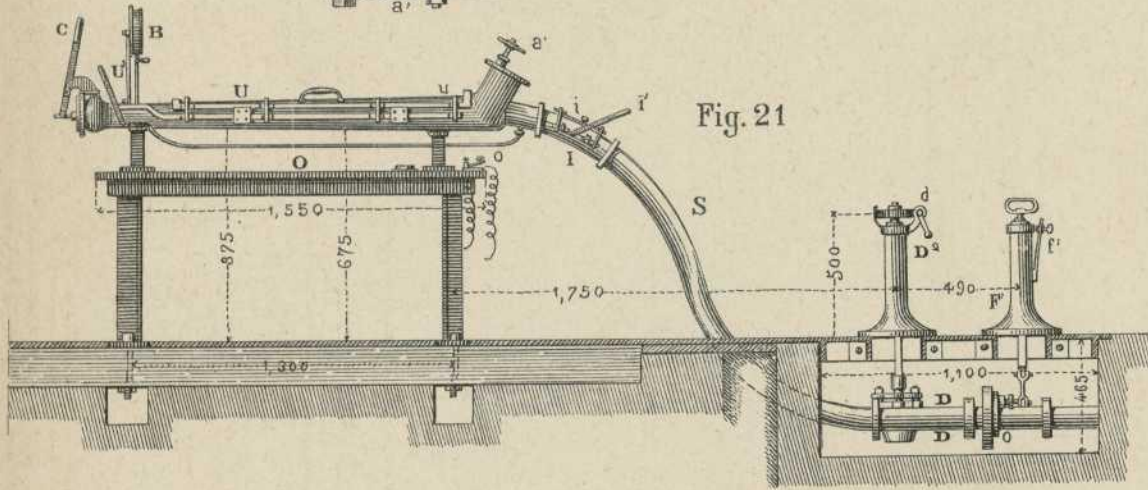


Fig. 21

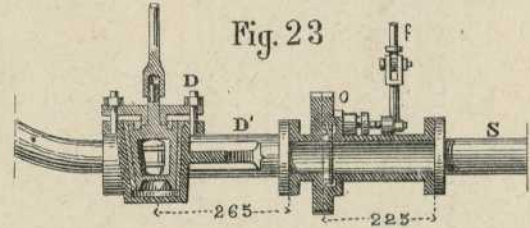


Fig. 23

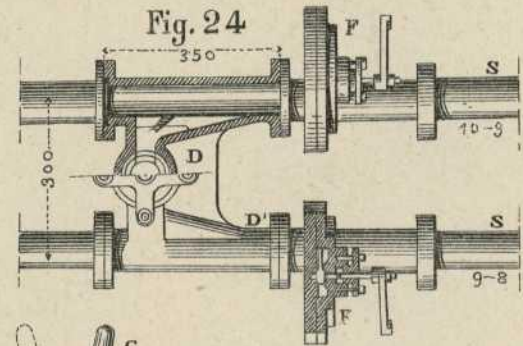


Fig. 24

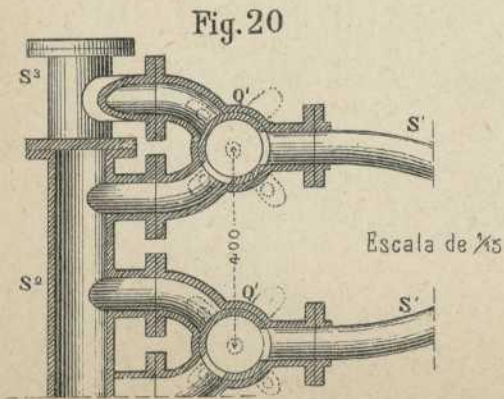


Fig. 20

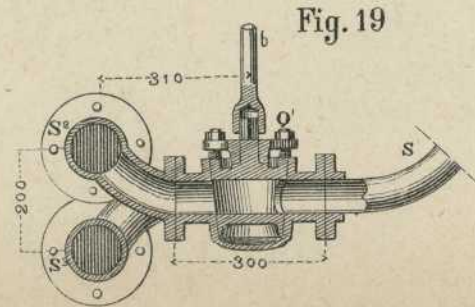


Fig. 19

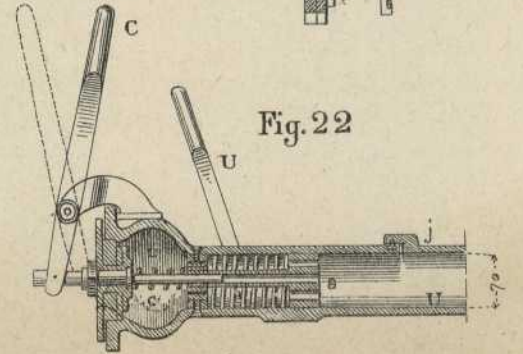


Fig. 22

BC

Fig. 1.

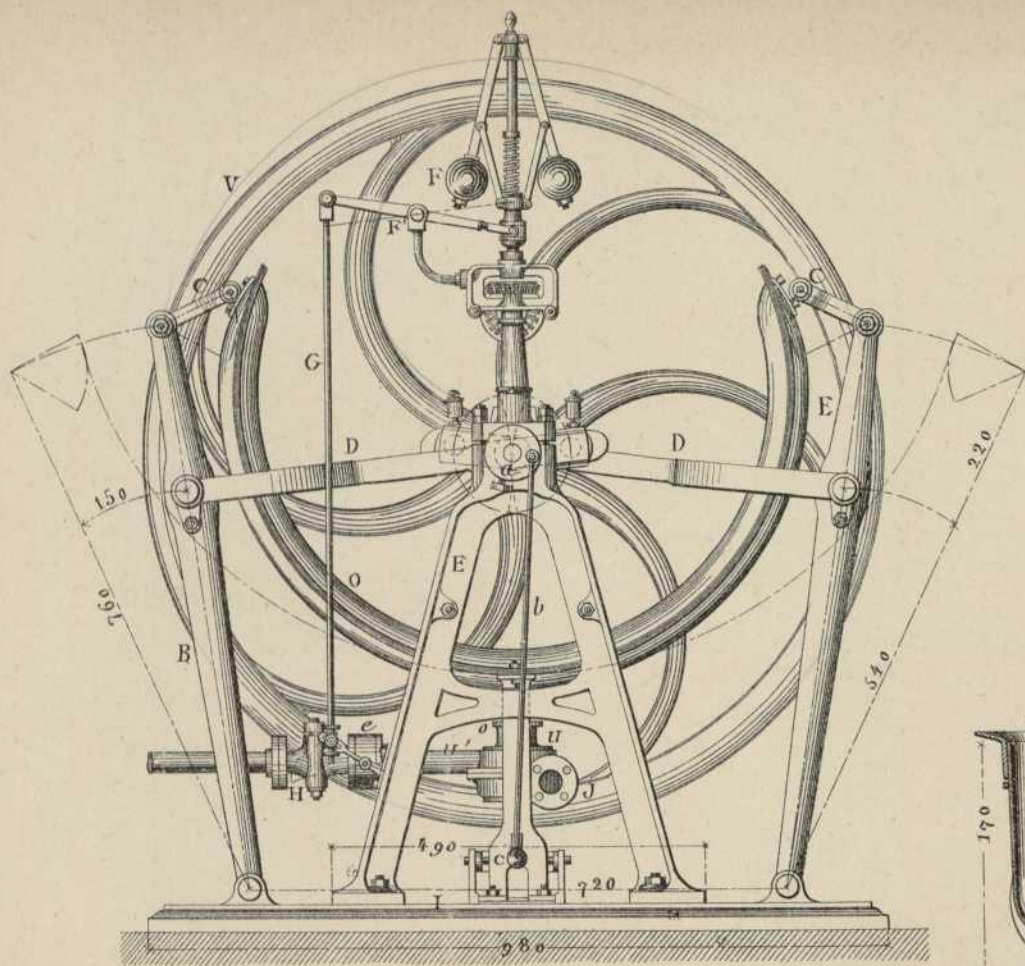
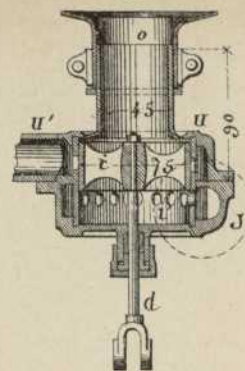


Fig. 4.



Escala de 1/3

Fig. 3.

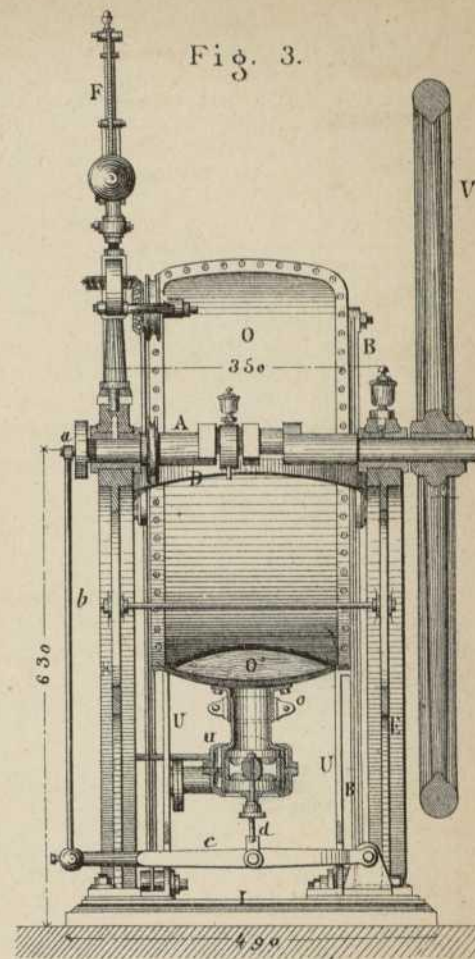


Fig. 5.

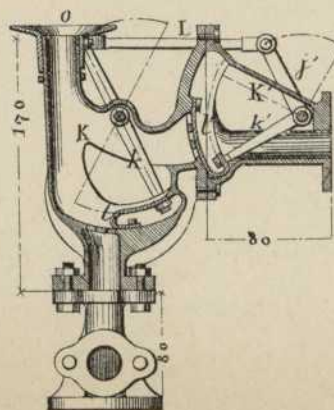
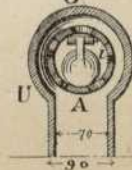


Fig. 10.

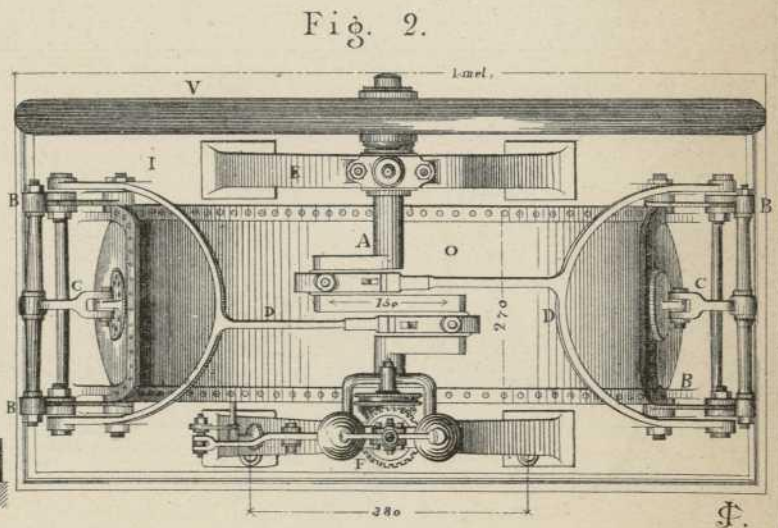
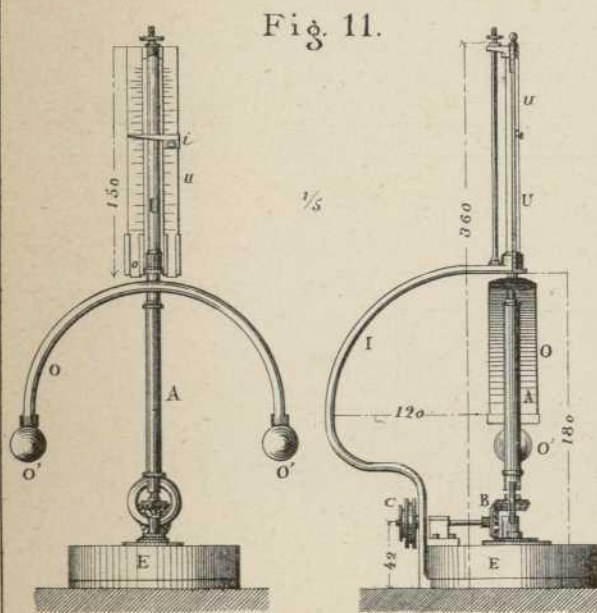
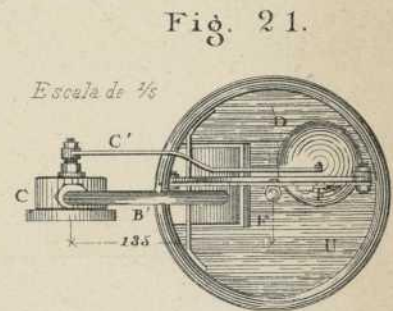
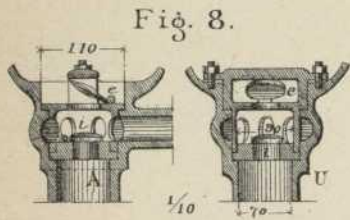
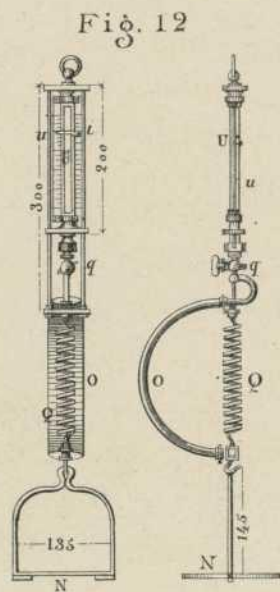
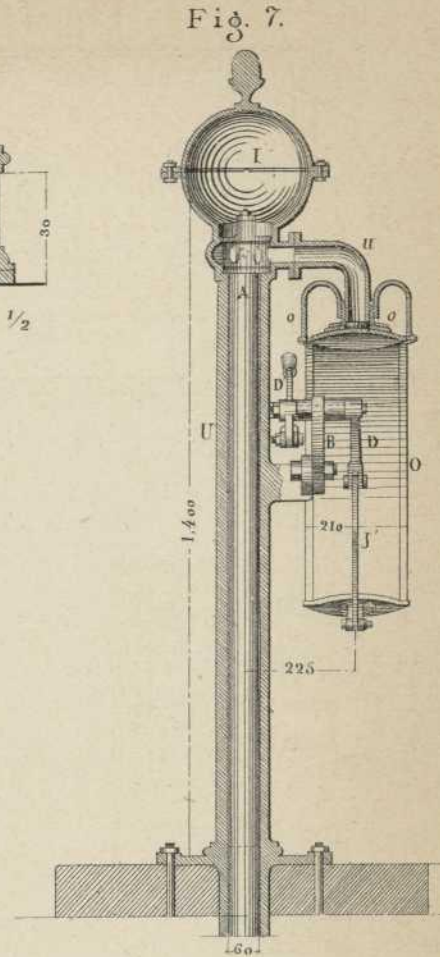
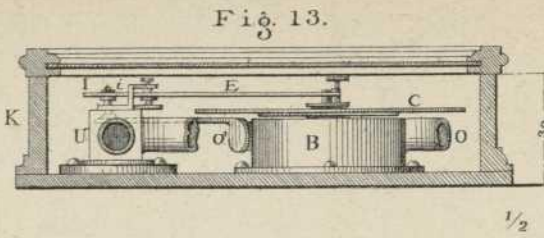
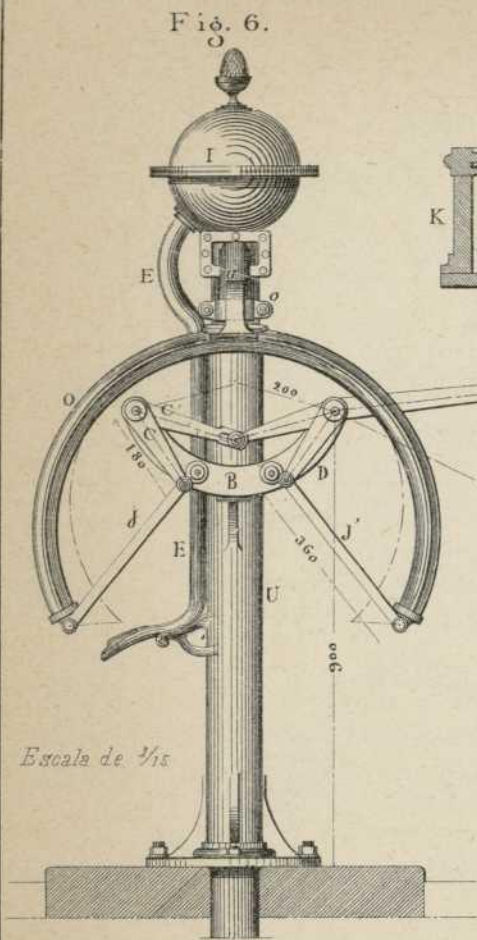


Escala de 1/10

Fig. 9.



Ⓕ.



1/2

Fig. 14

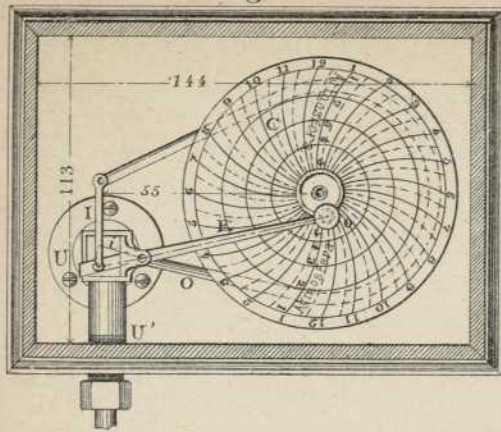


Fig. 15

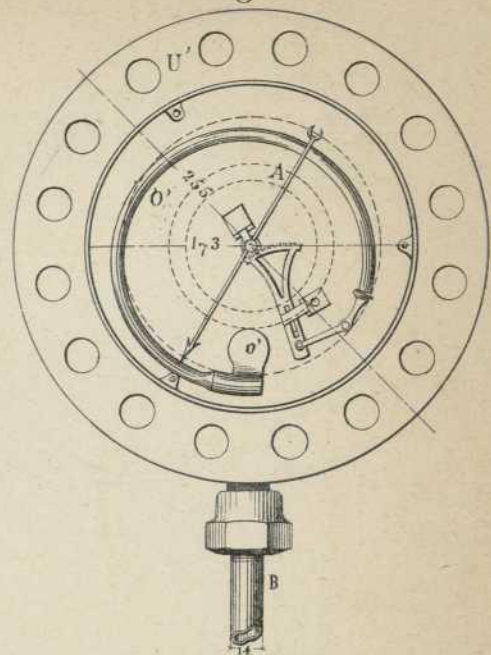


Fig. 16.

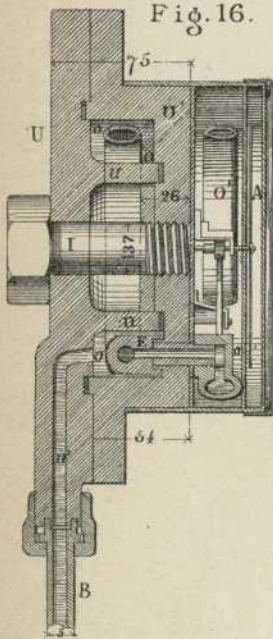
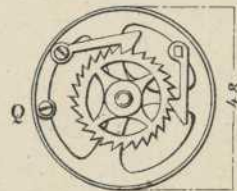


Fig. 26.



Escala de 1/2

Fig. 27.

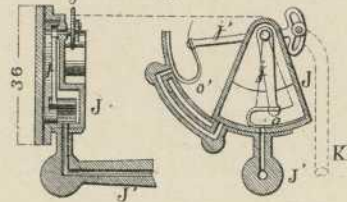


Fig. 17.

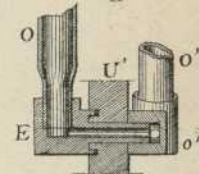


Fig. 18.

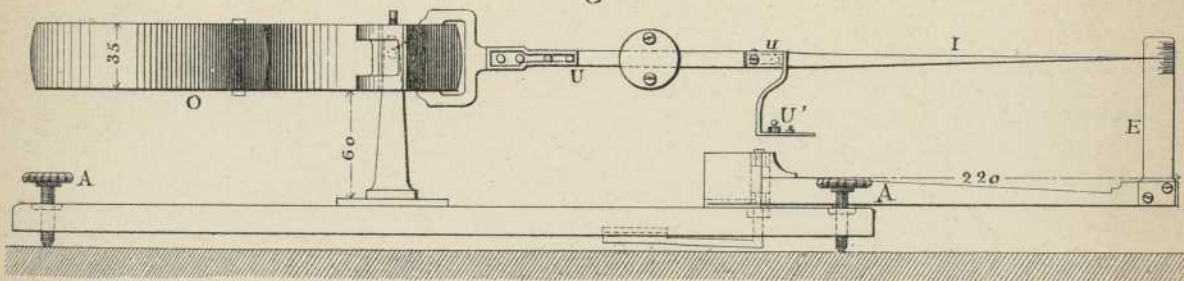
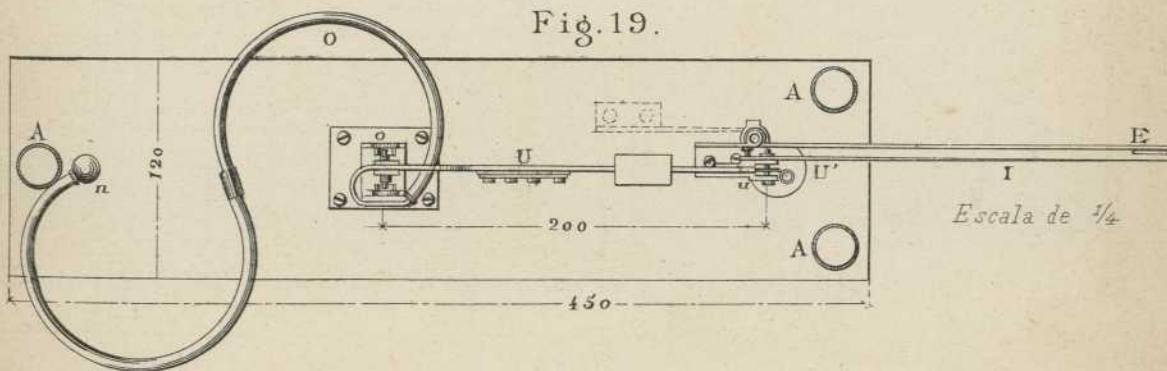


Fig. 19.



Ⓕ.

Fig. 23.

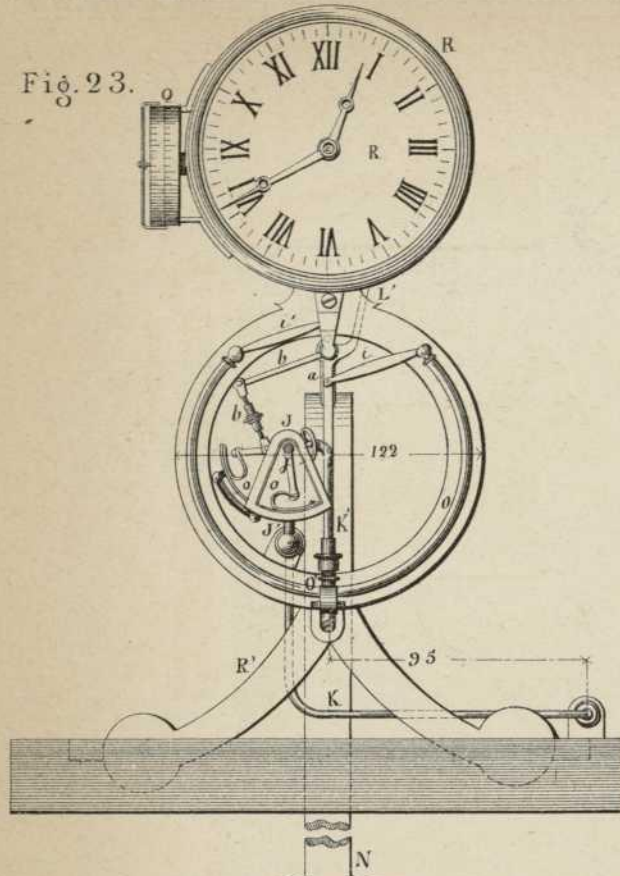


Fig. 24.

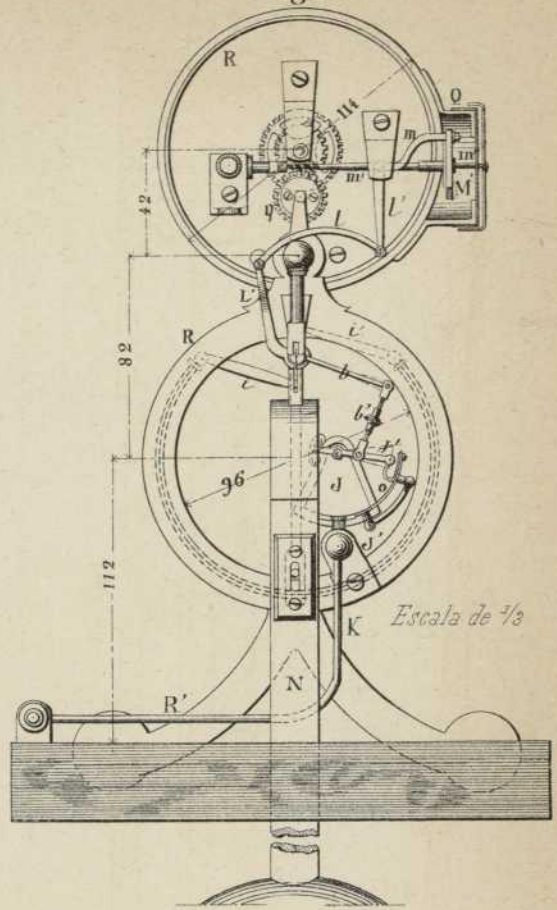


Fig. 25.

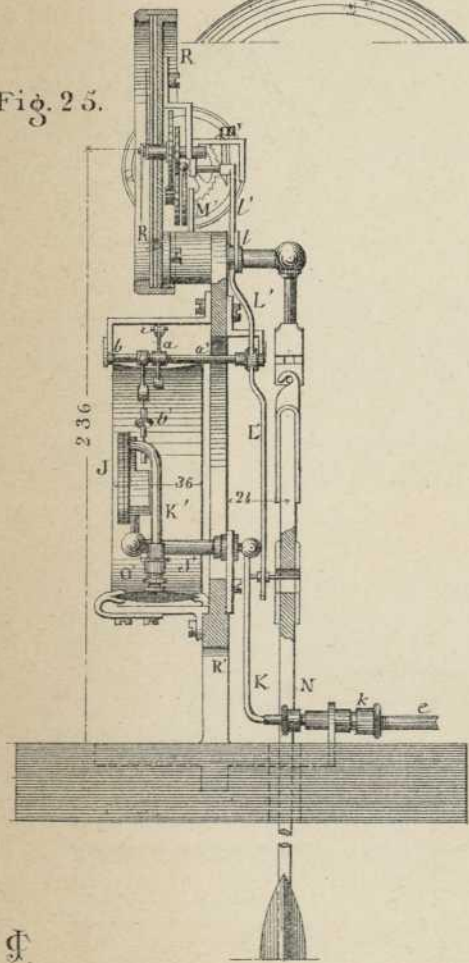


Fig. 22.

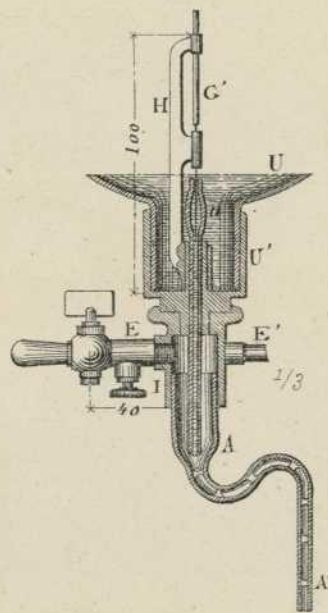
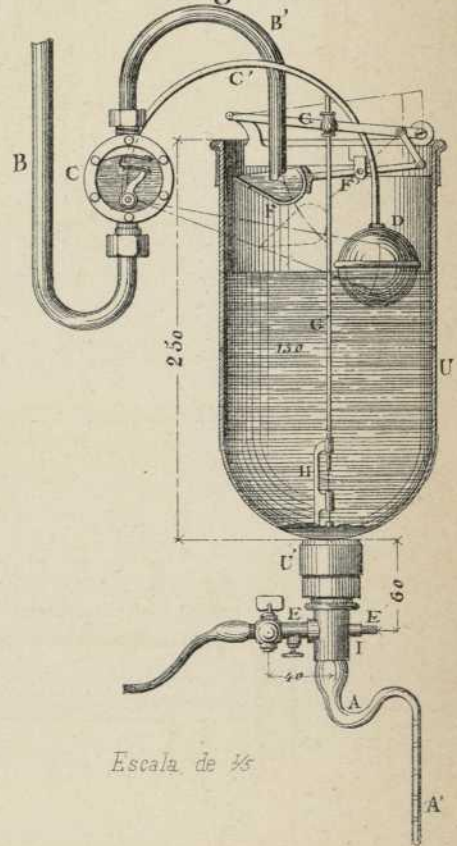
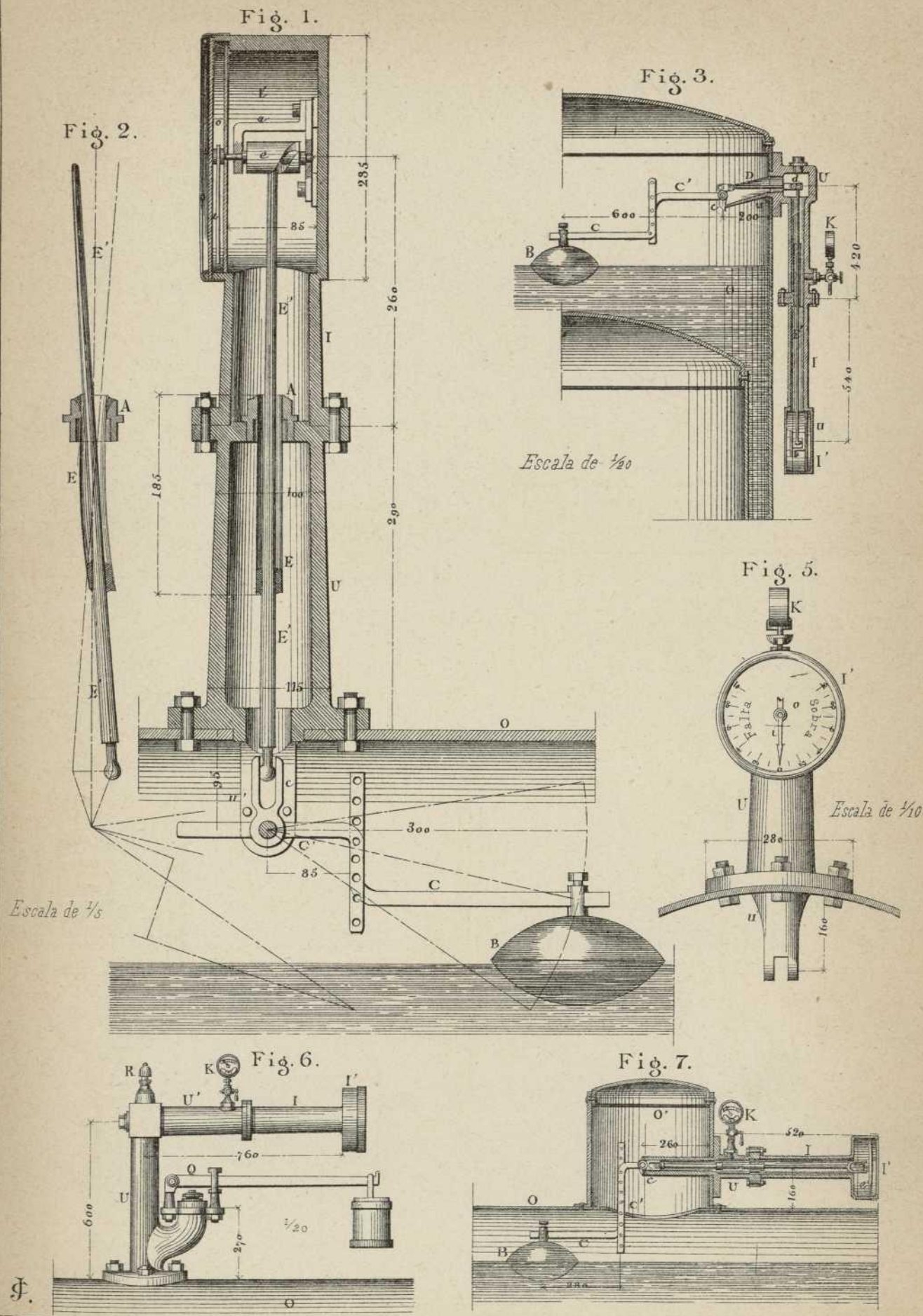
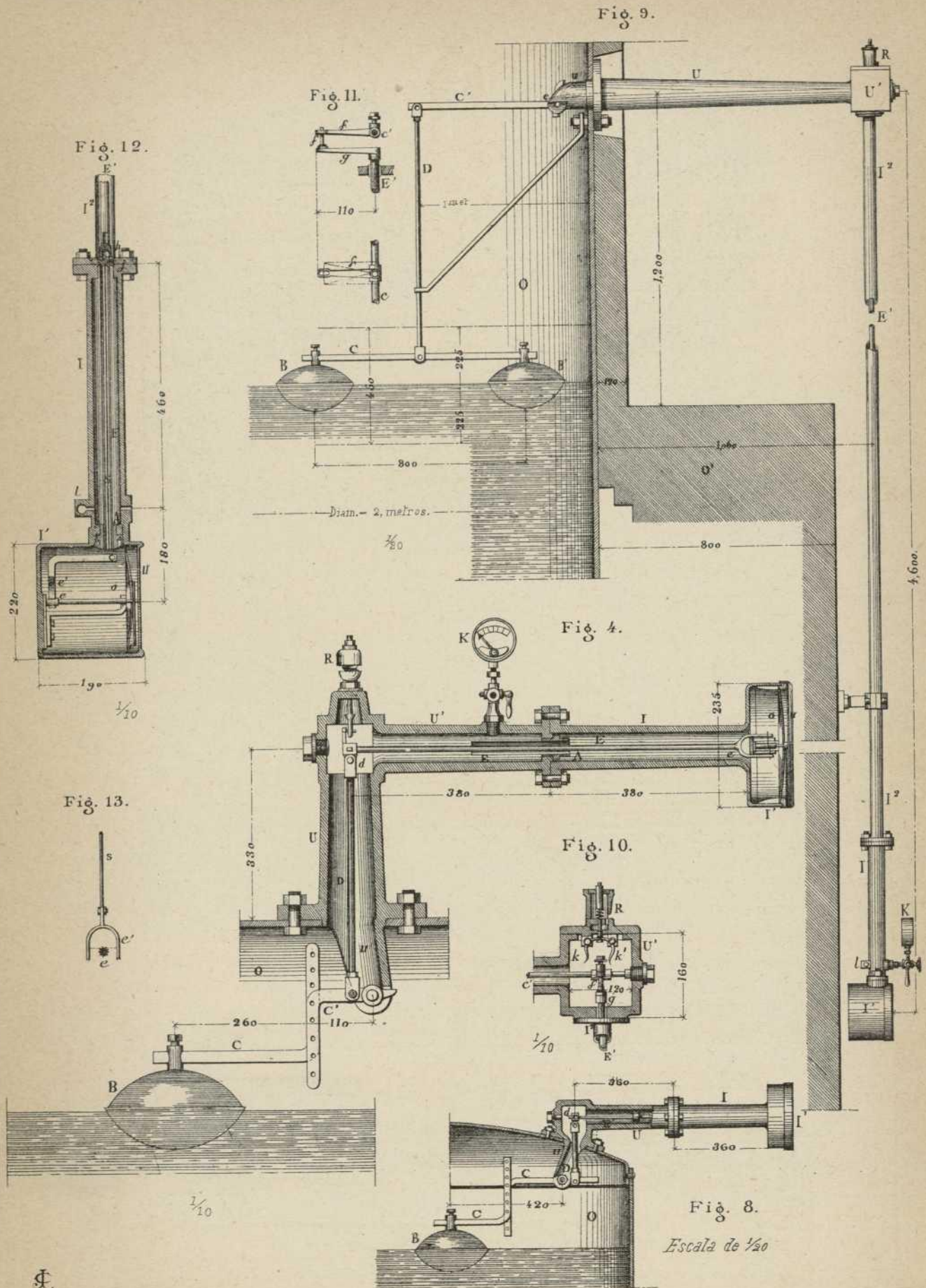


Fig. 20.



Ⓕ





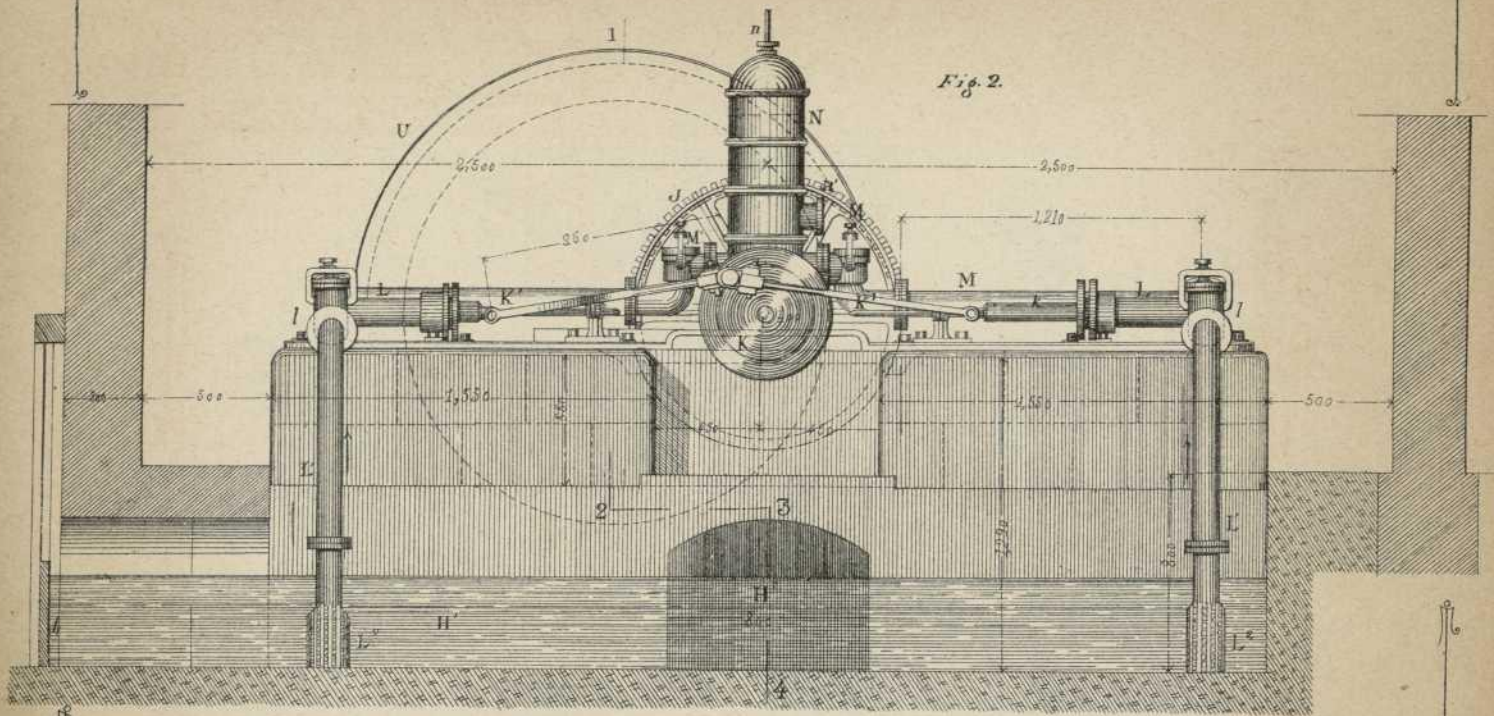
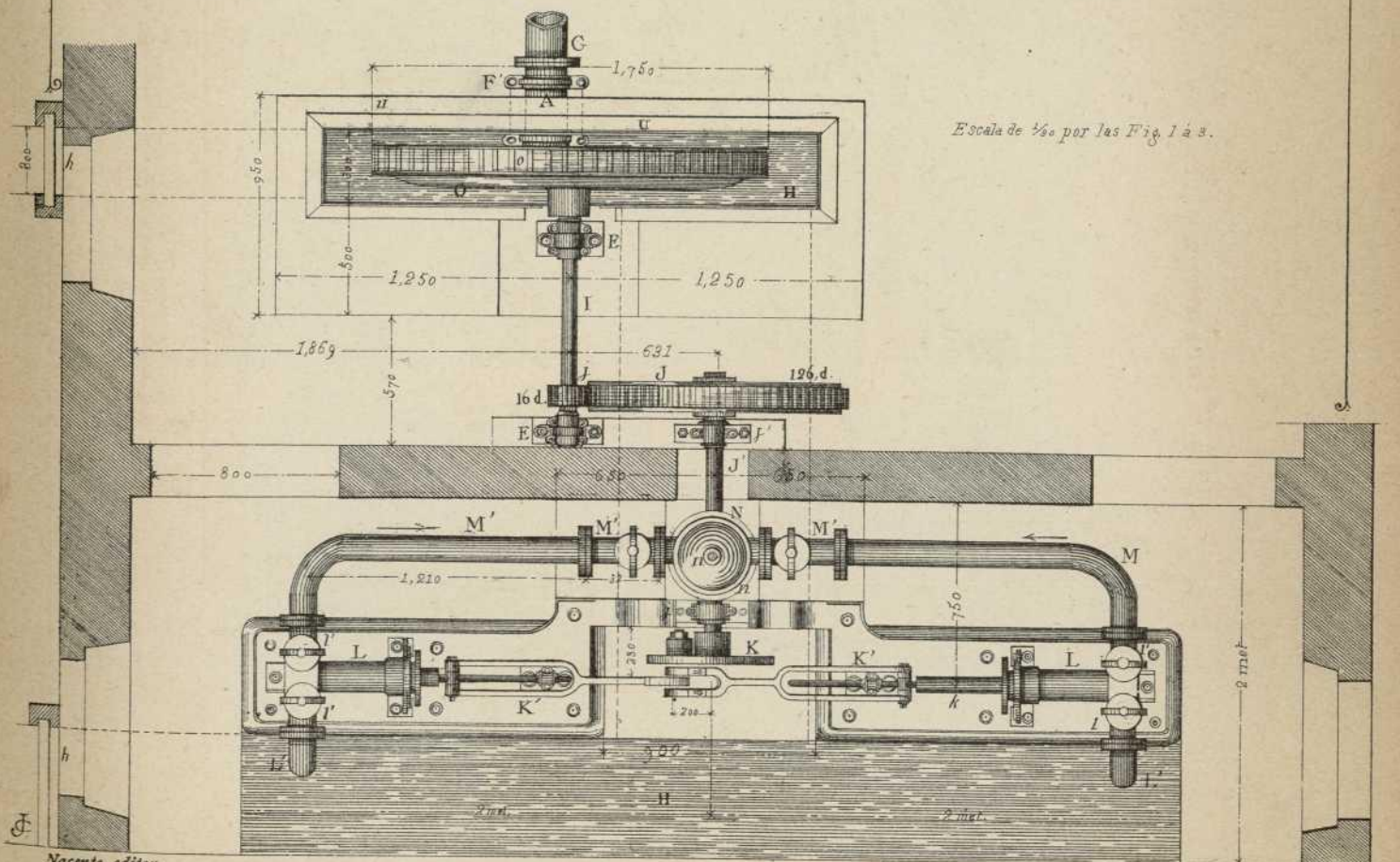


Fig. 2.

Fig. 1.



Escala de 1/50 por las Fig. 1 à 3.

Fig. 3.

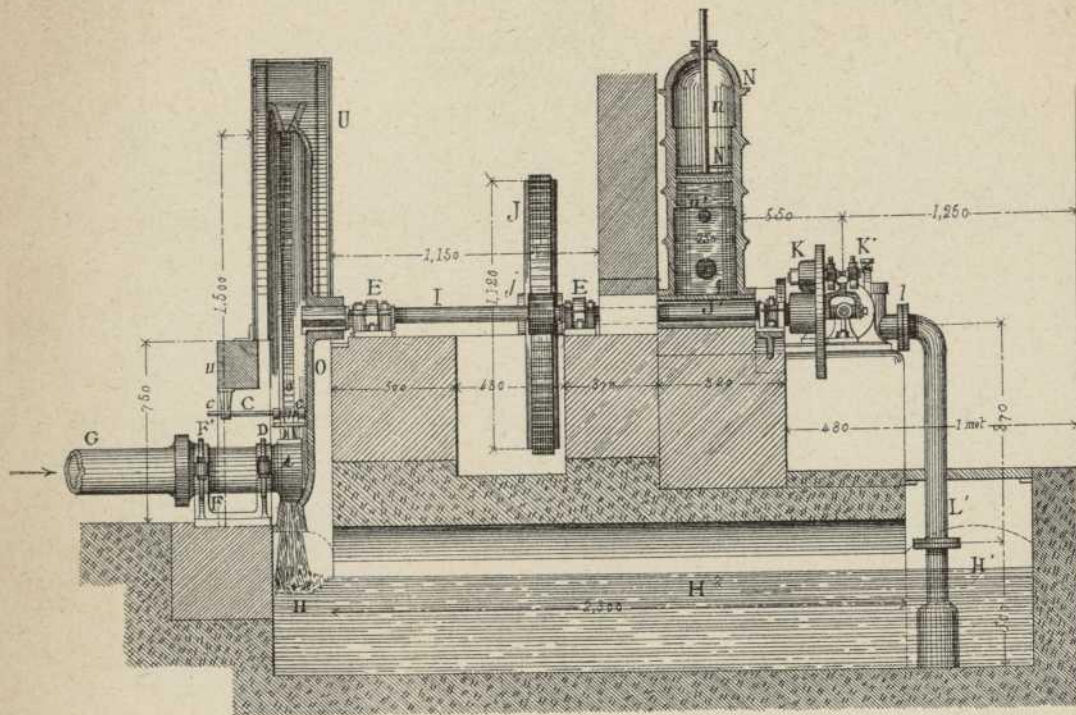


Fig. 6.

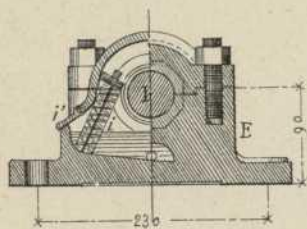


Fig. 7.

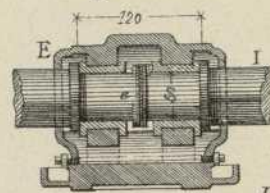
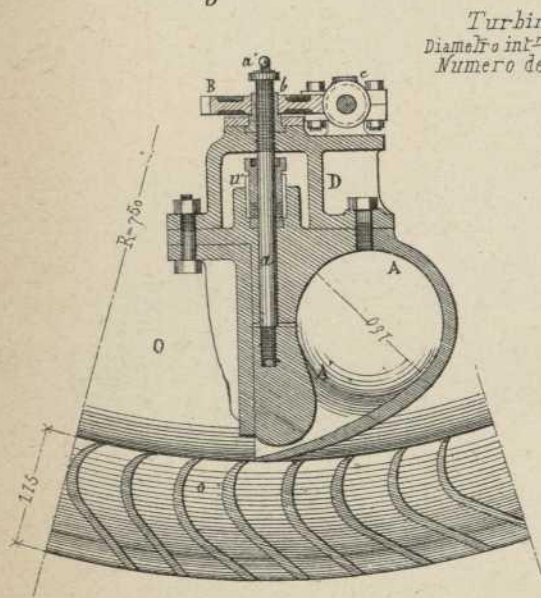


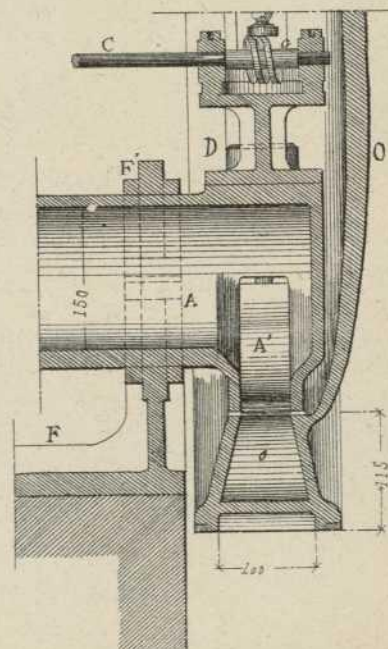
Fig. 5.

Fig. 4.



Turbina
Diámetro int.^o 1,500 metro
Número de Alas 94.

Escala de 1/45 por las Fig. 4 y 7.



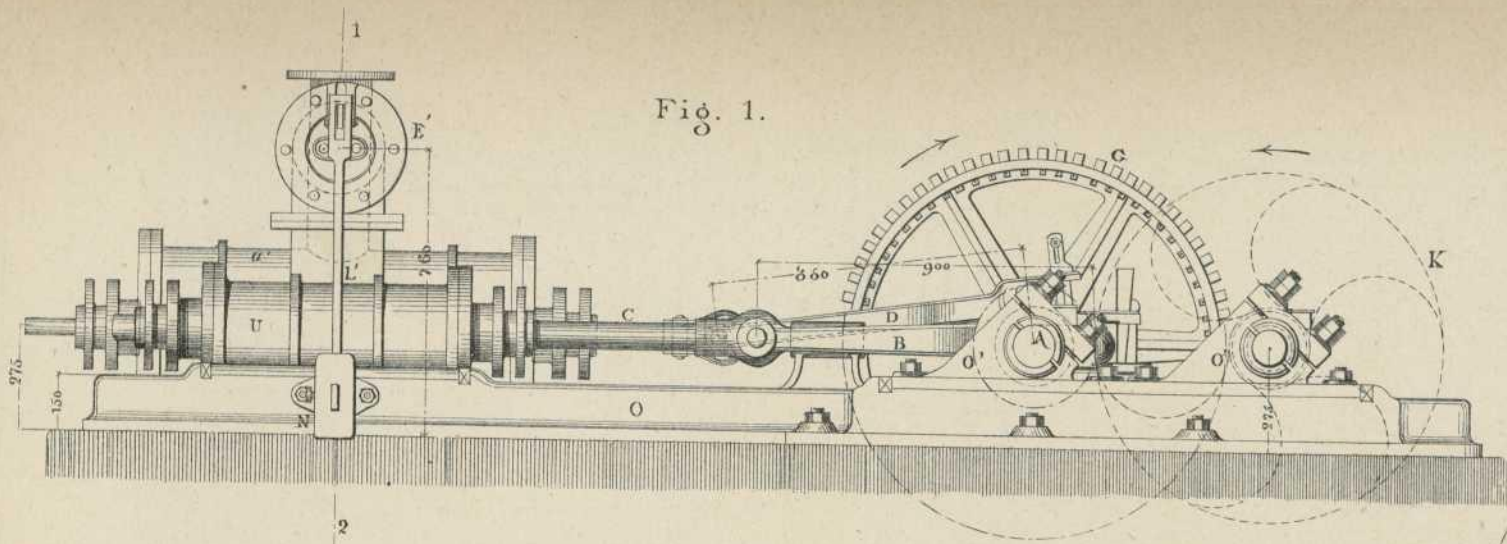


Fig. 1.

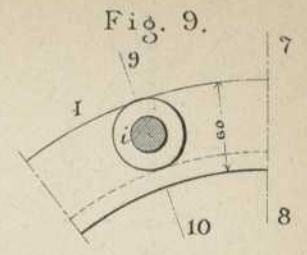


Fig. 9.

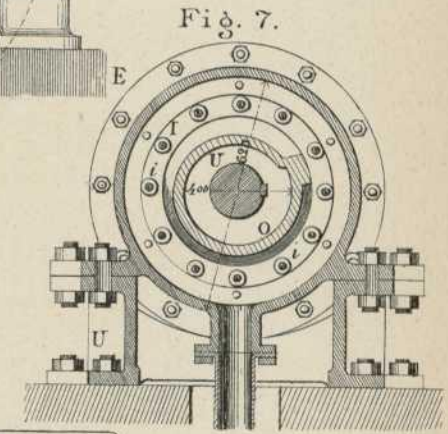


Fig. 7.

Fig. 10.



Fig. 2.

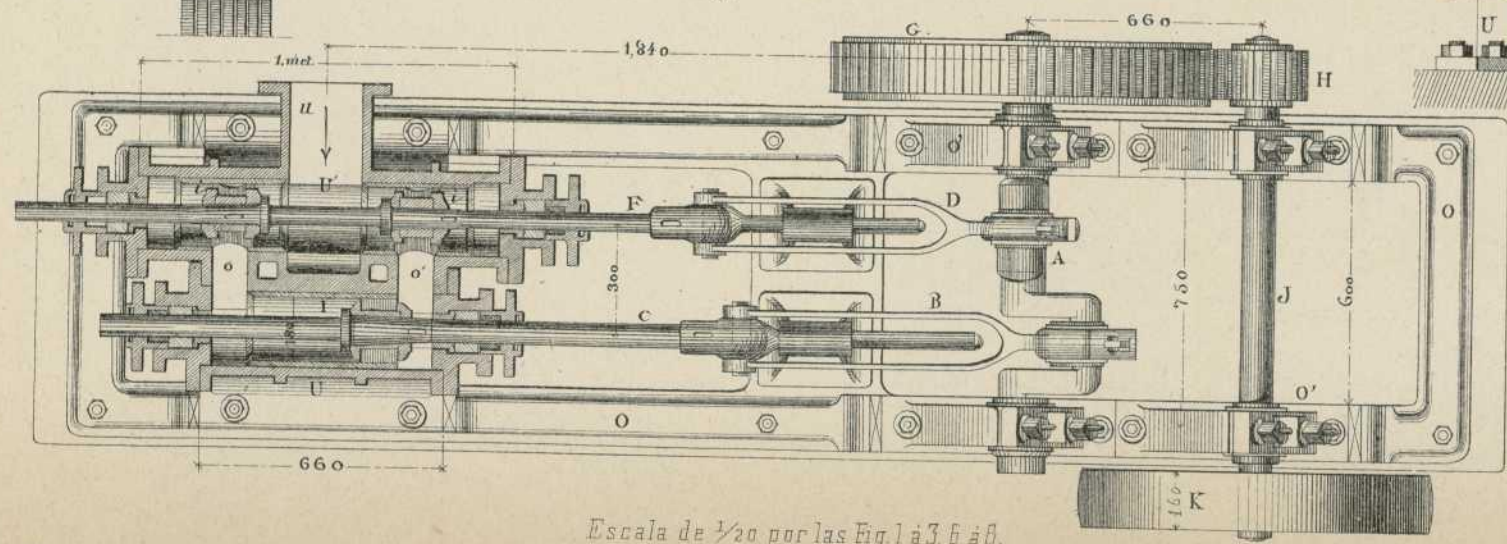
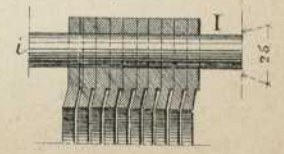


Fig. 11.



Escala de 1/20 por las Fig. 1 à 3, 6 à 8.



Fig. 5.

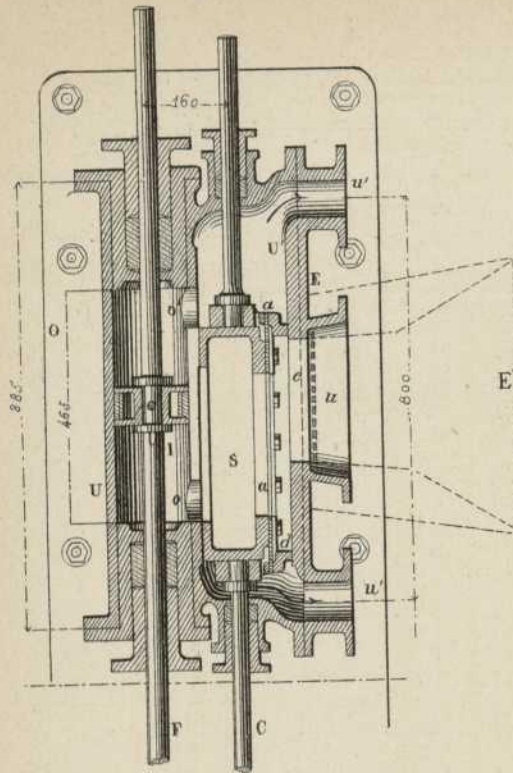


Fig. 6.

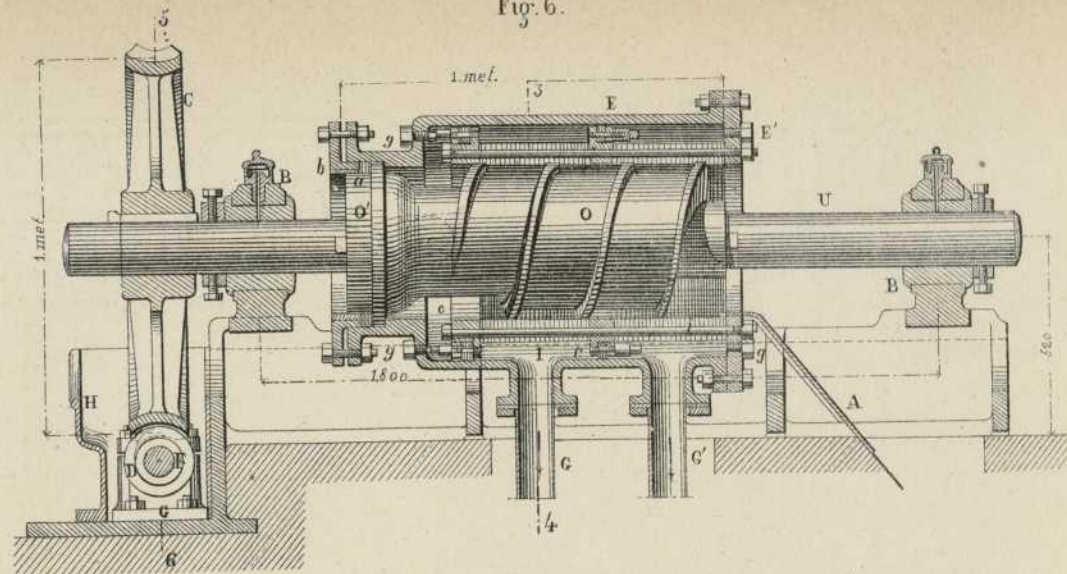


Fig. 8.

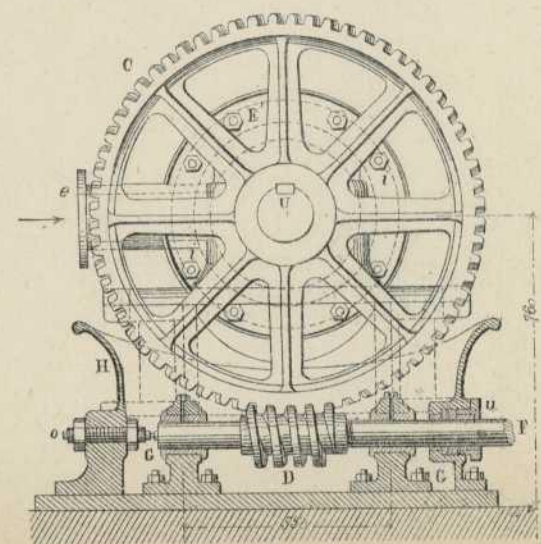


Fig. 3.

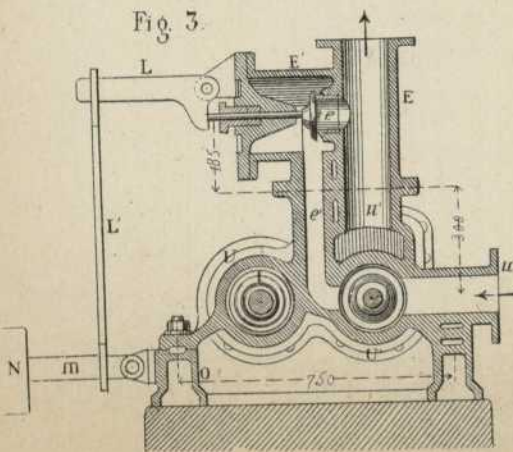
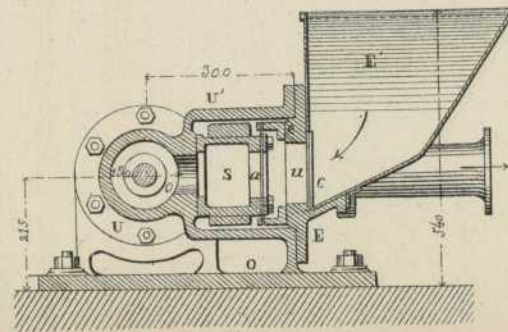


Fig. 4.



Escala de 1/15 por las Fig. 4 à 5.

Fig. 2.

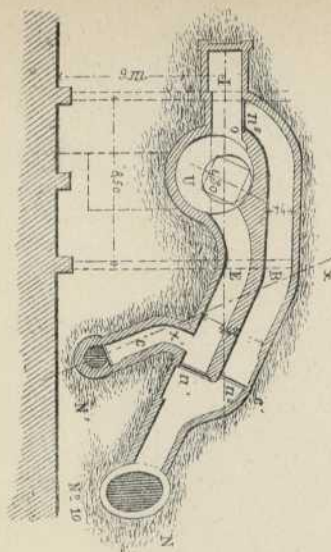
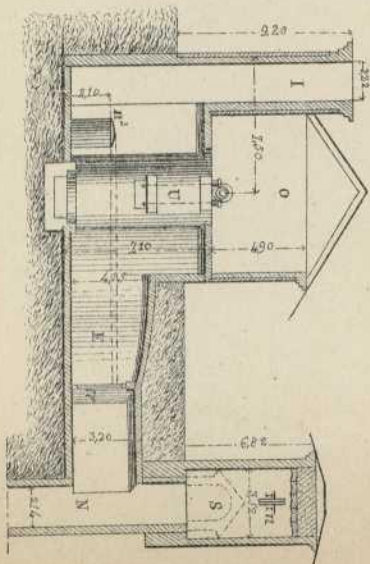


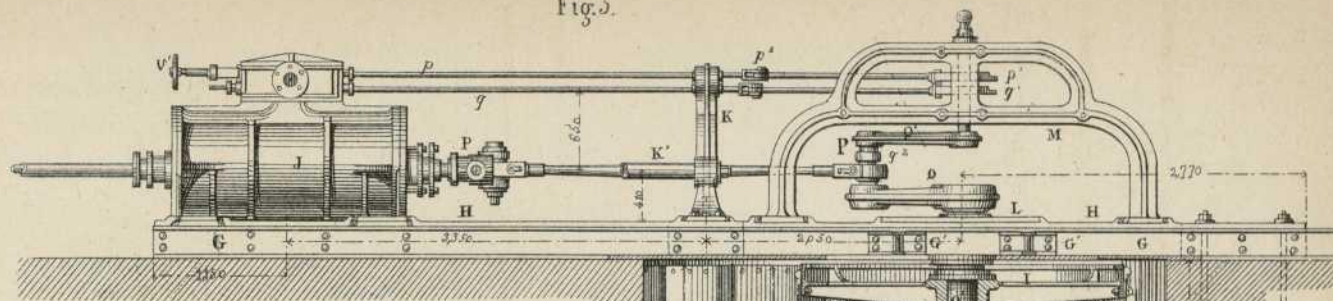
Fig. 1.



EM.

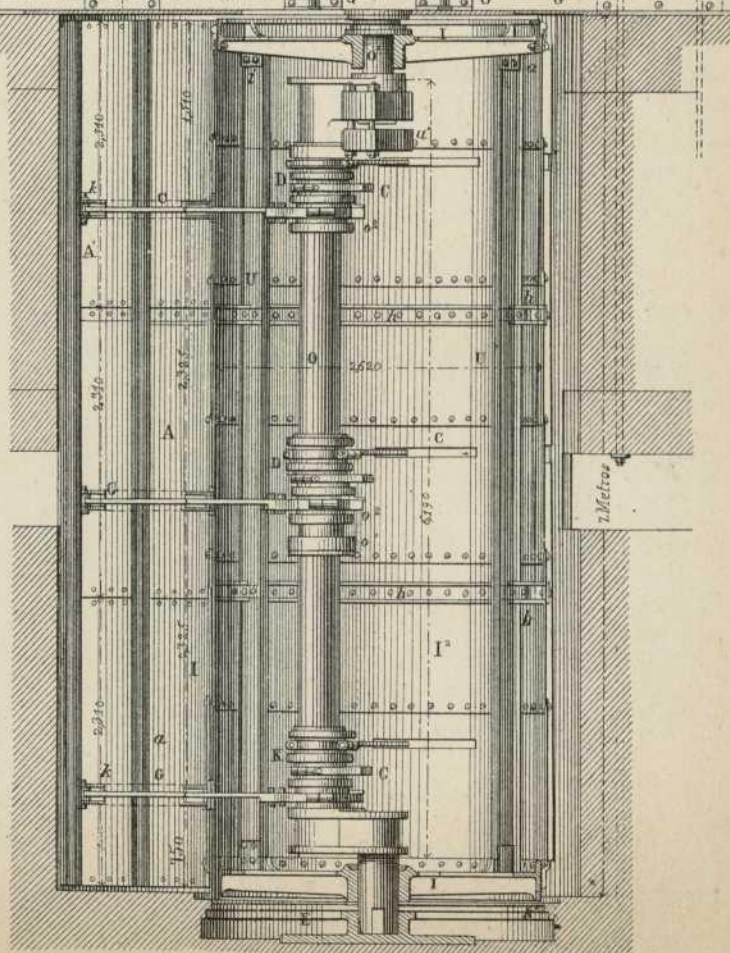
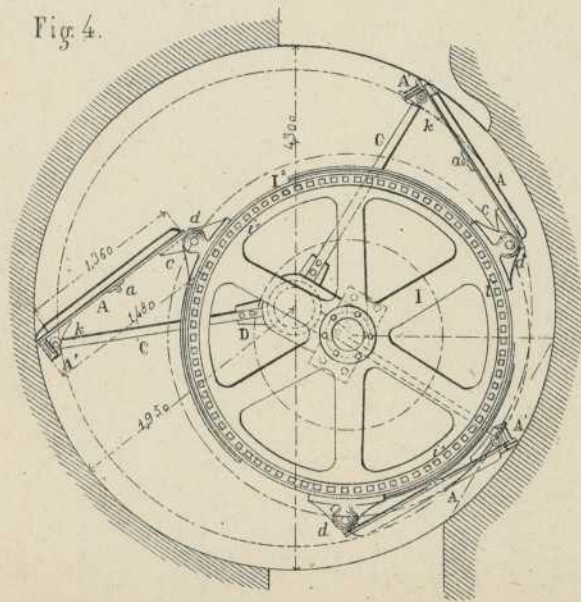
Nacente, editor.

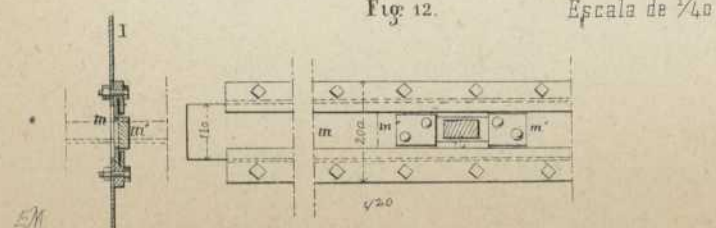
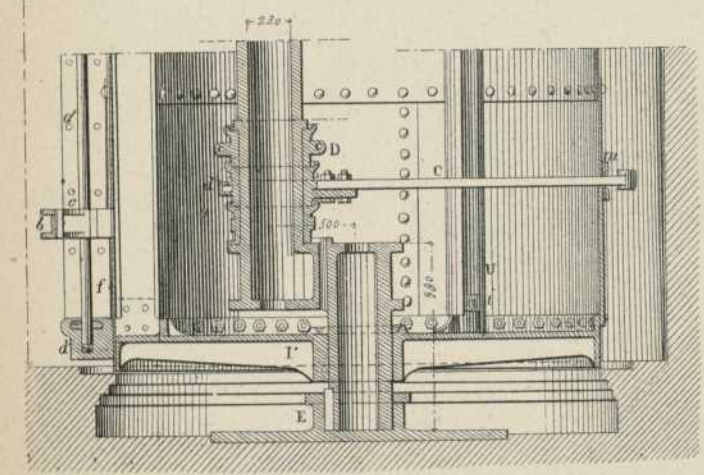
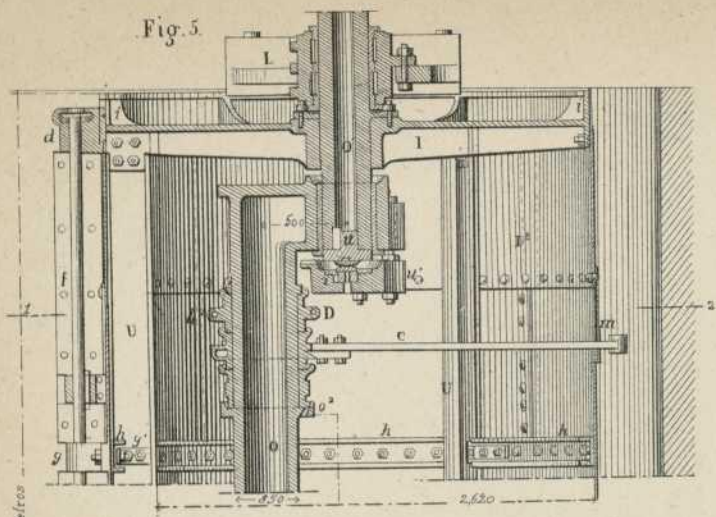
Fig. 3.



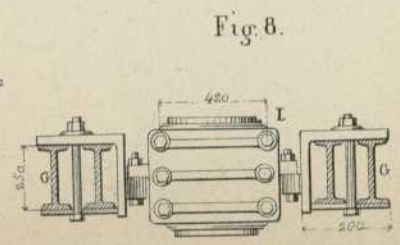
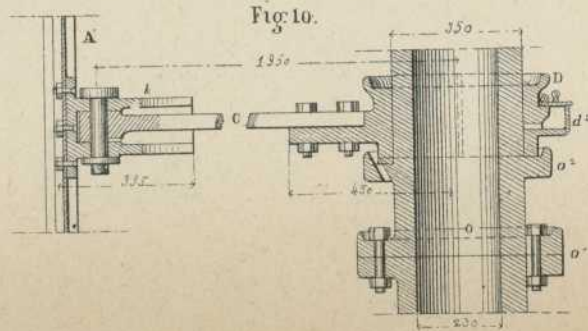
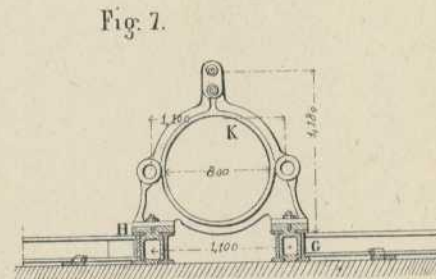
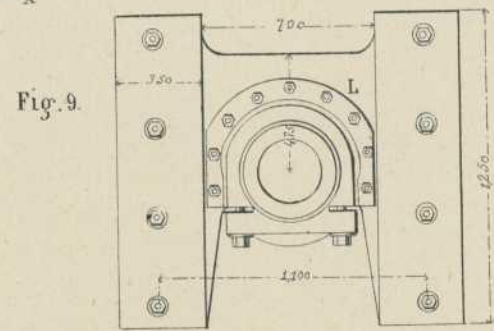
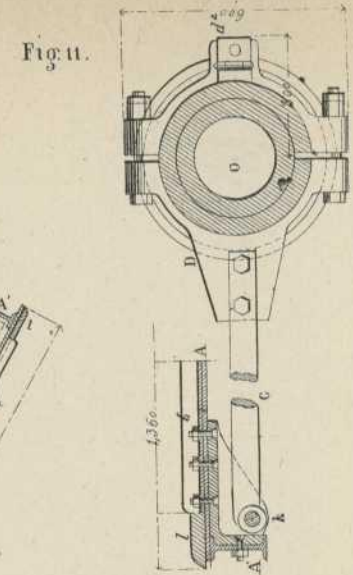
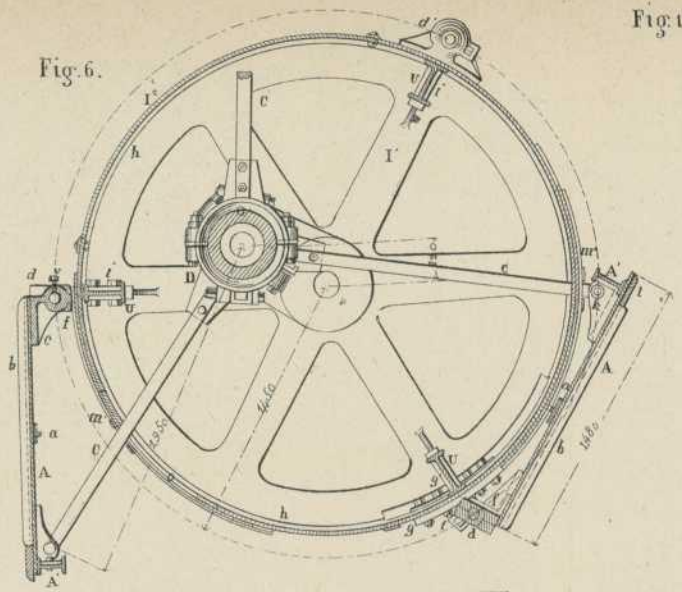
Escala de 1/60

Fig. 4.

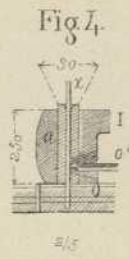
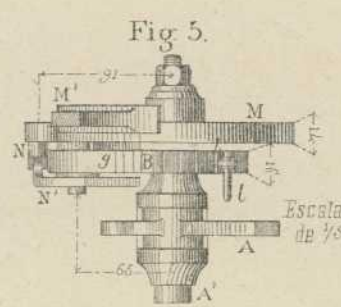
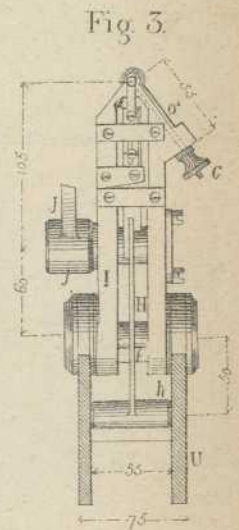
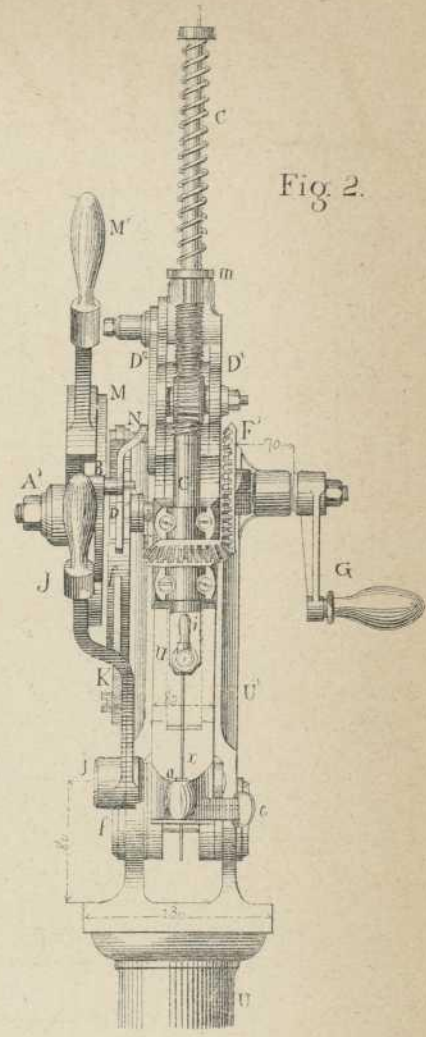
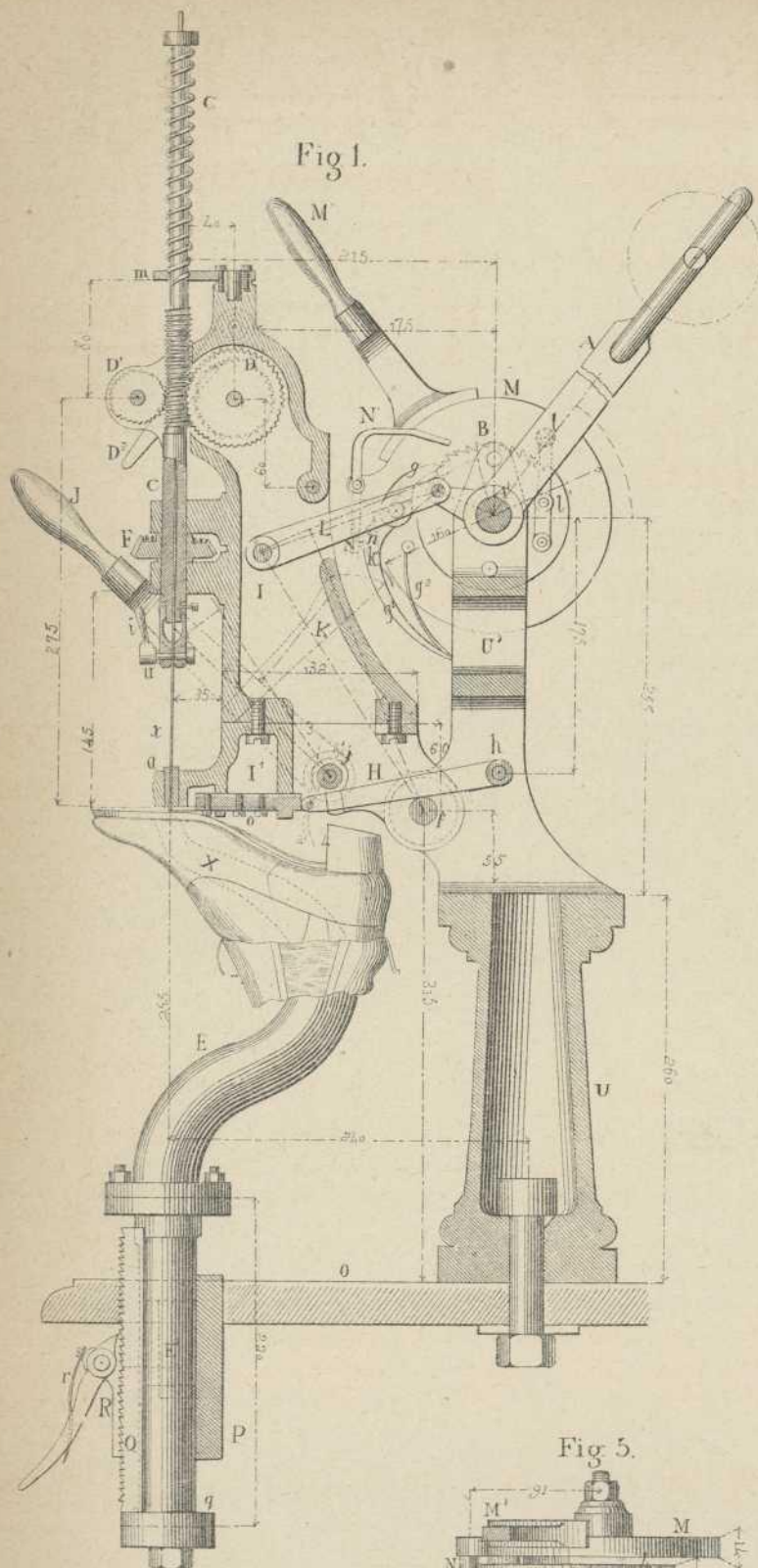


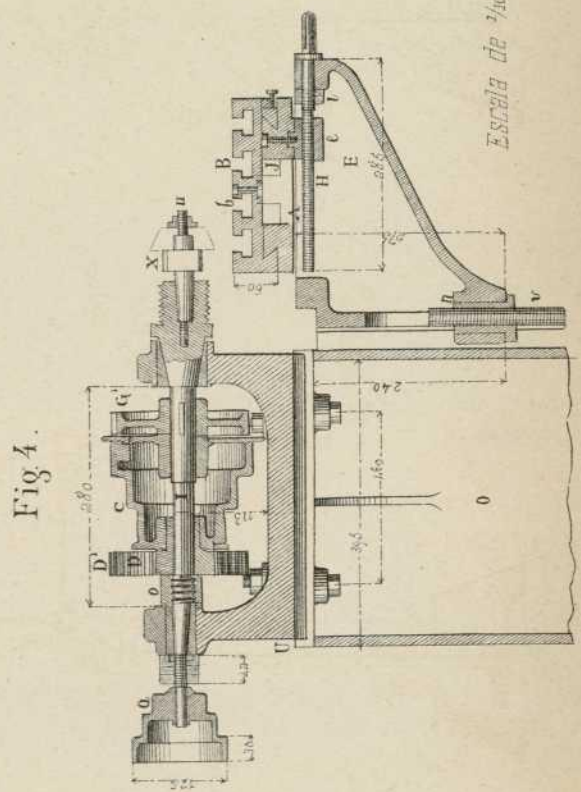
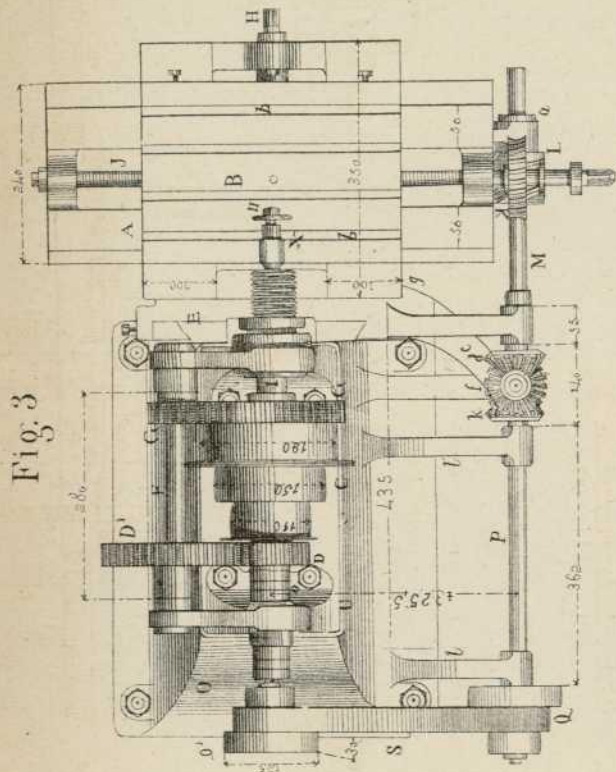
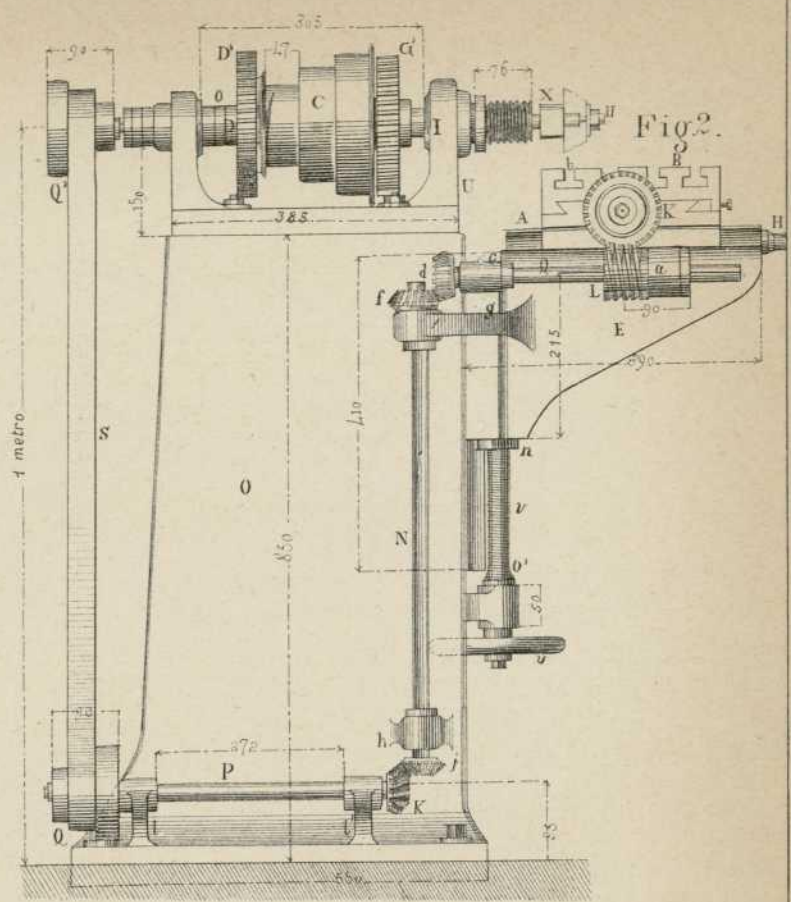
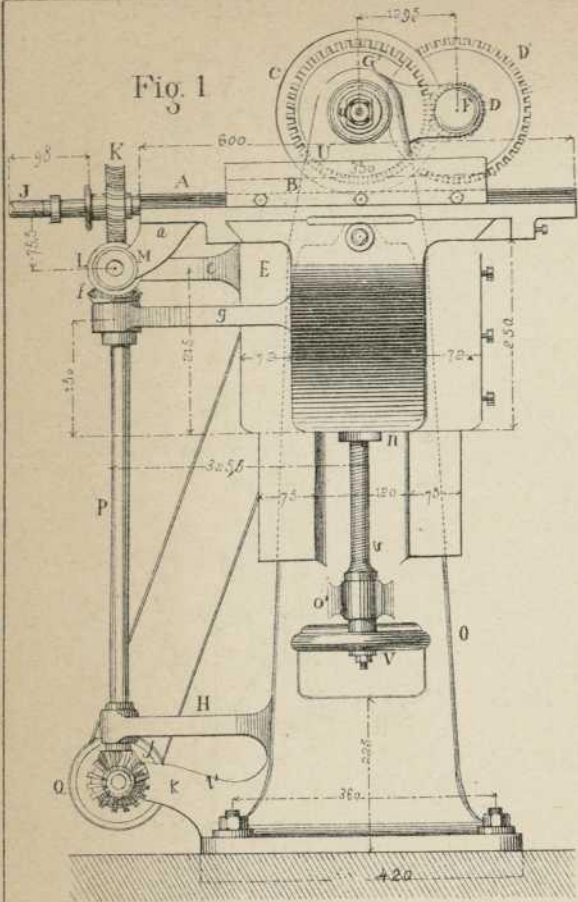


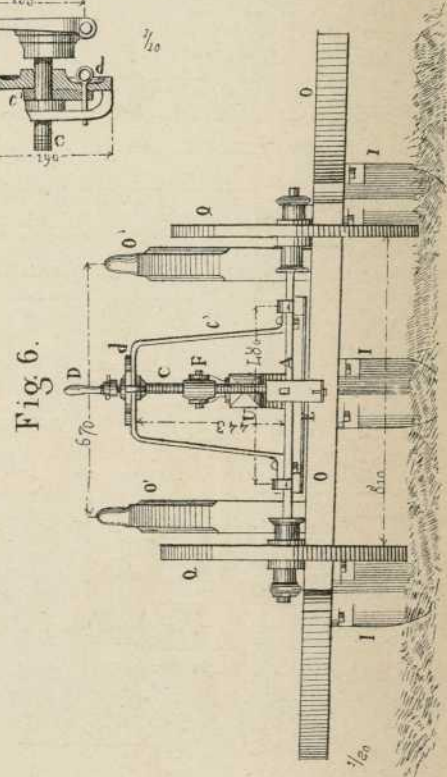
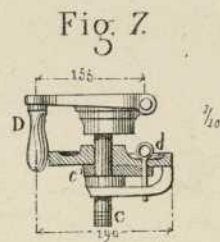
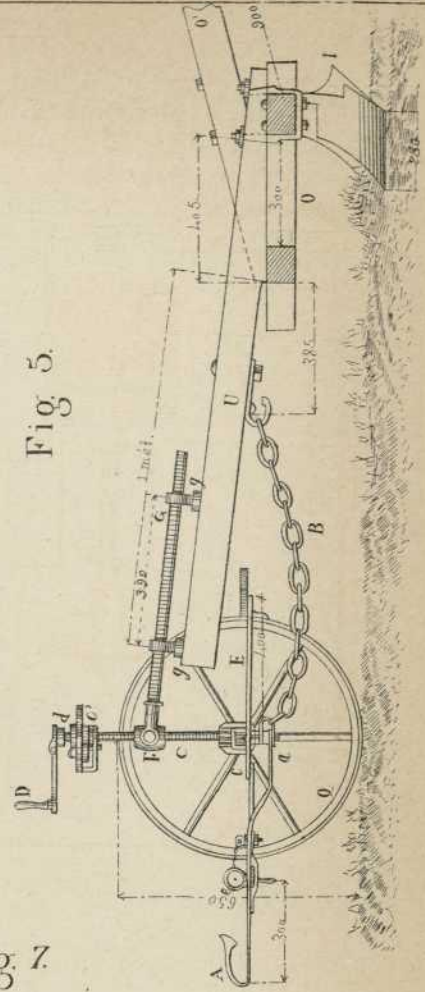
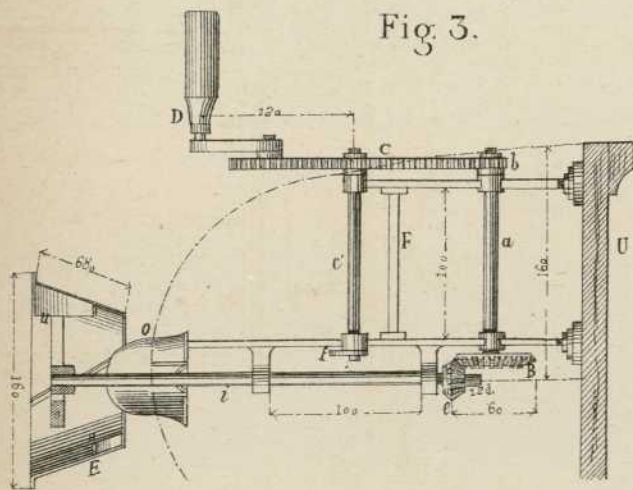
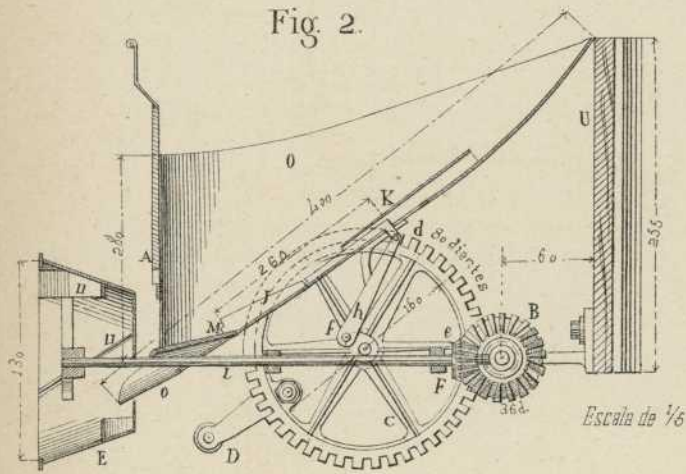
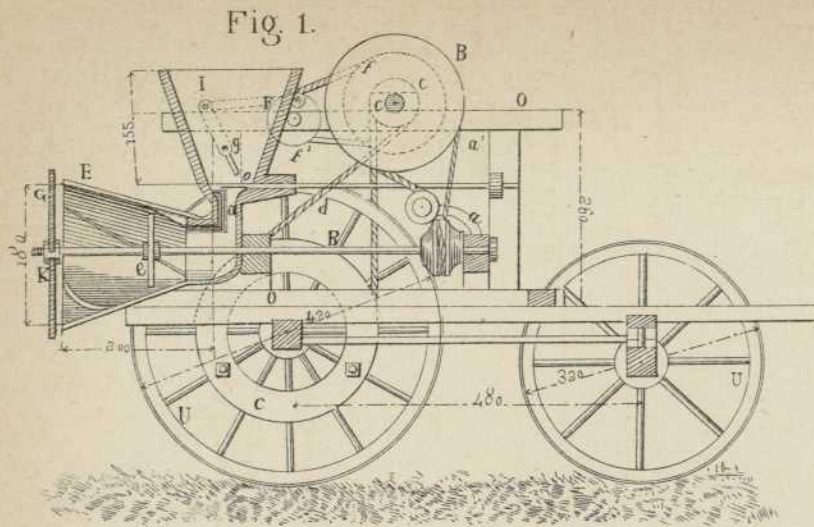
Nacente, editor.



Paseo de Gracia, 145.







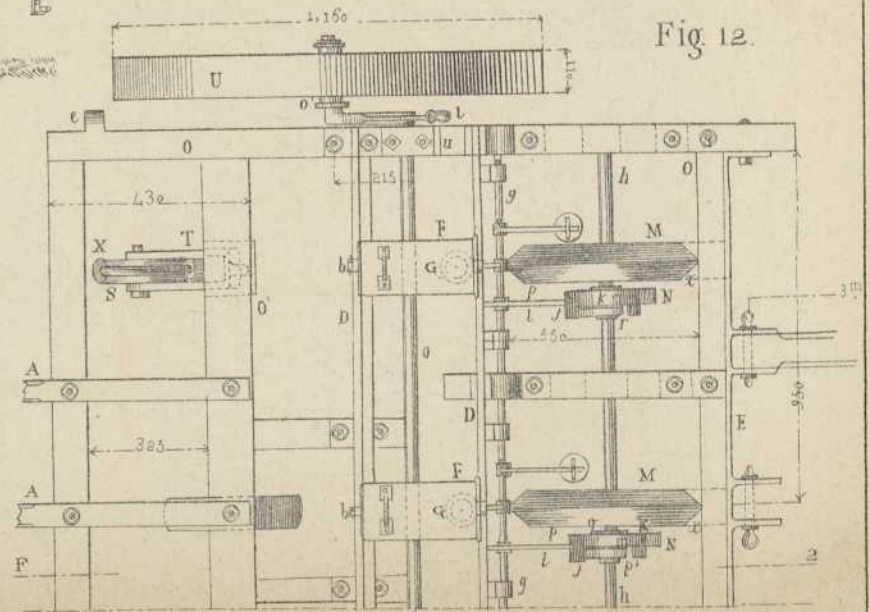
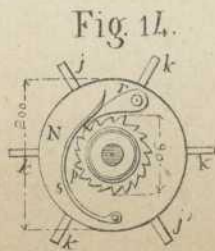
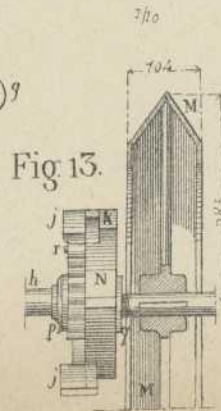
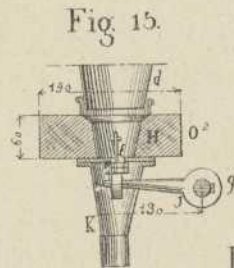
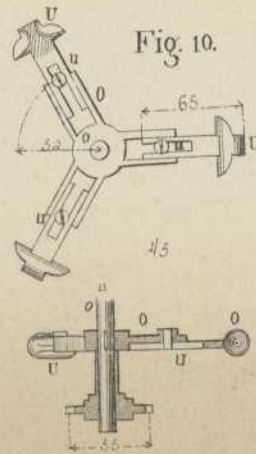
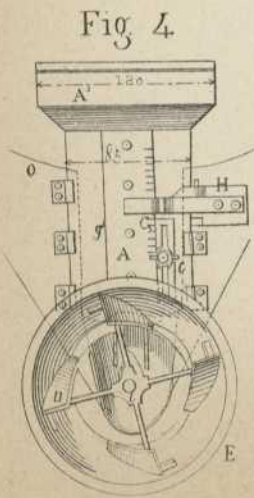
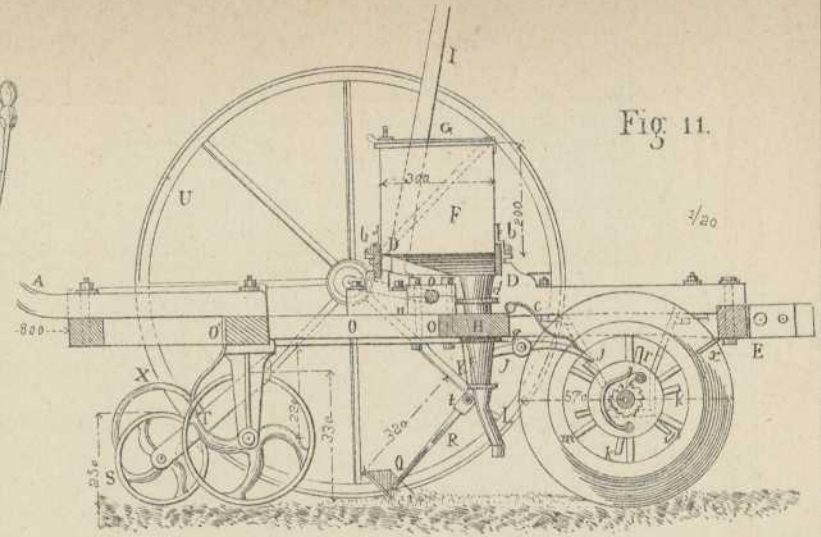
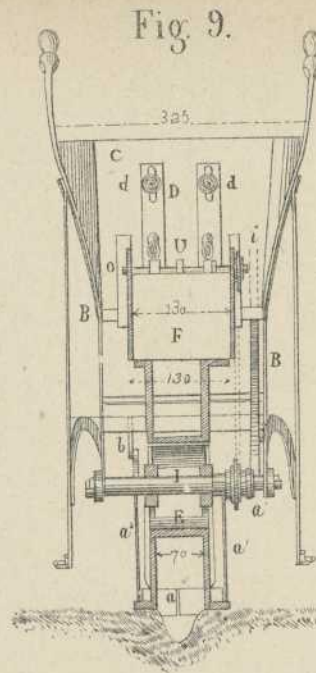
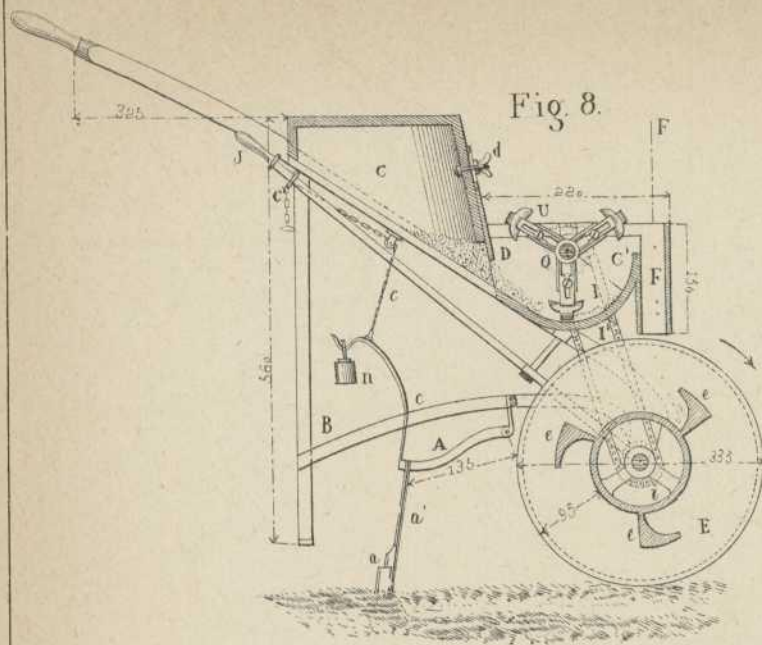
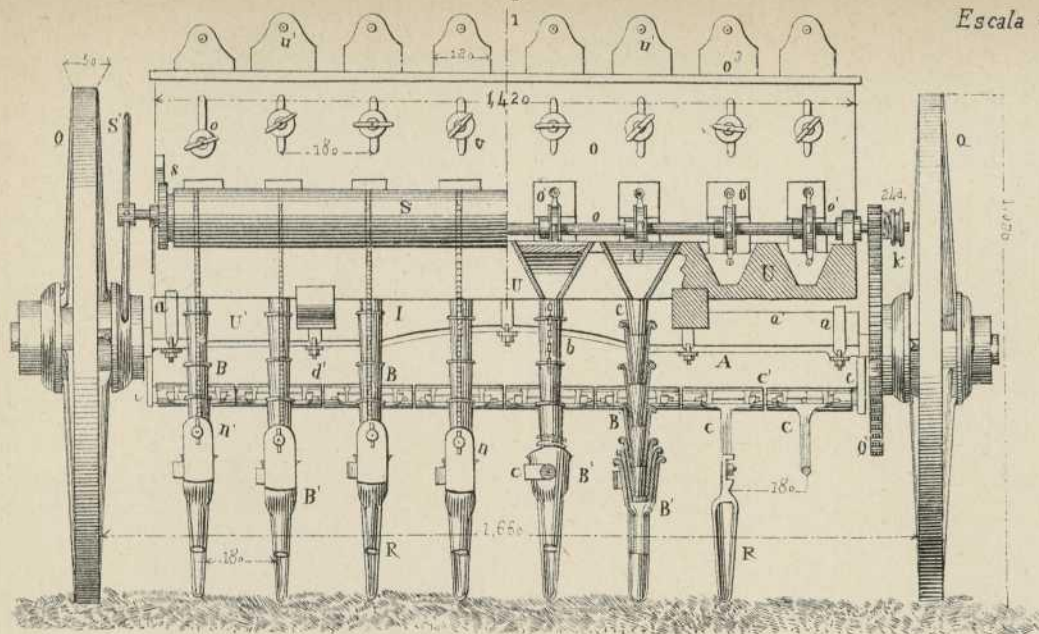


Fig. 6.



Escala de 1/5

Fig. 1.

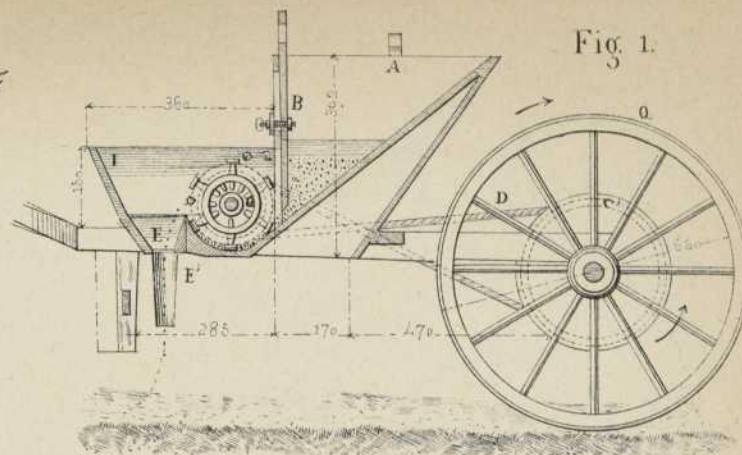


Fig. 5.

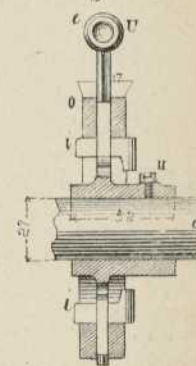


Fig. 4.

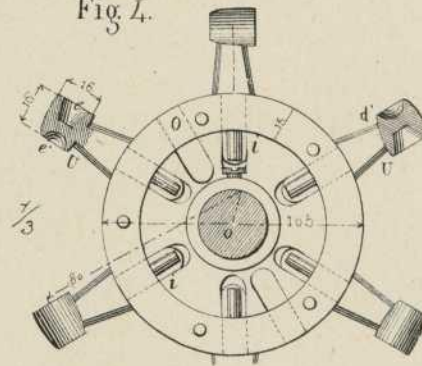


Fig. 2.

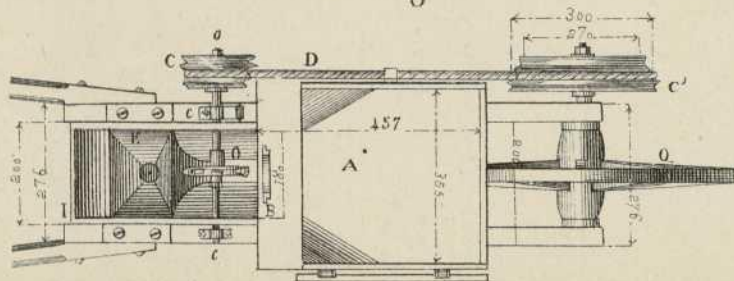


Fig. 3.

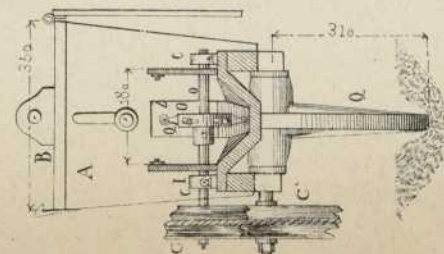


Fig 7.

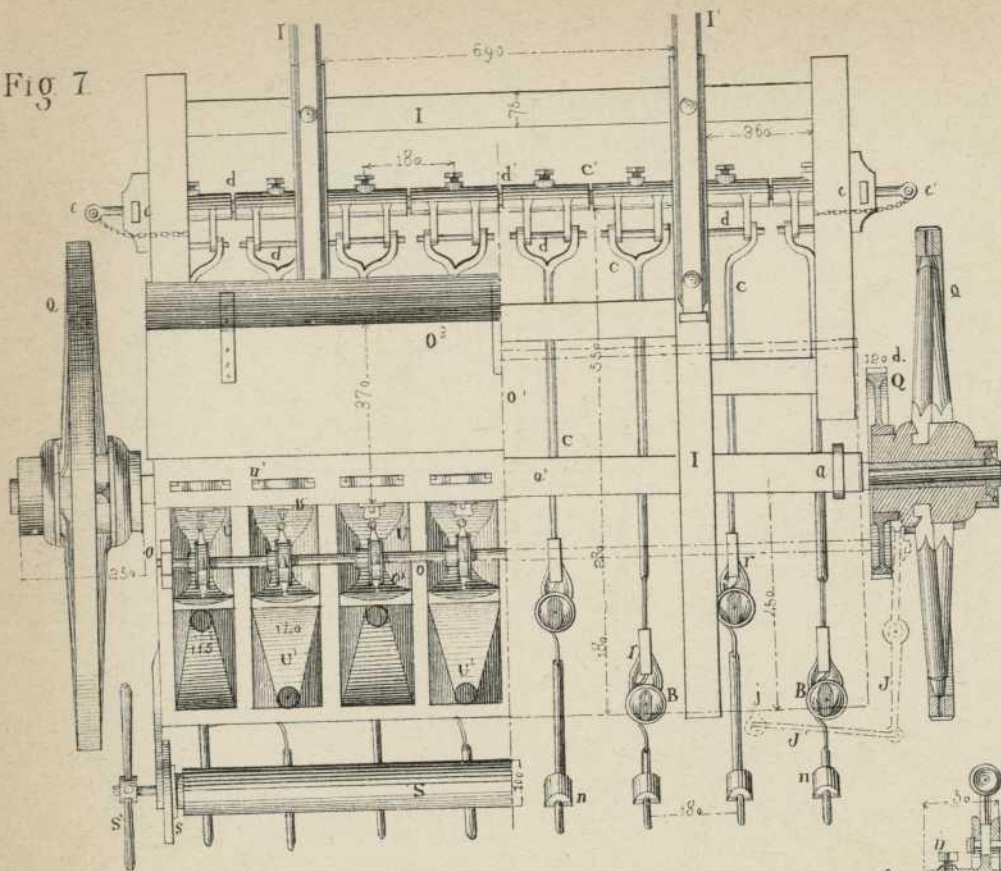
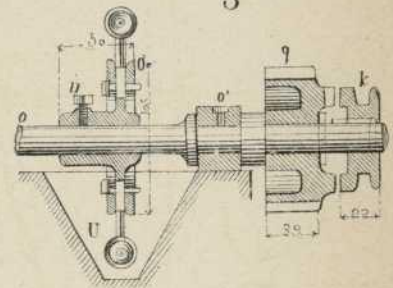


Fig 11.



Fig 9.



Escala de 1/3

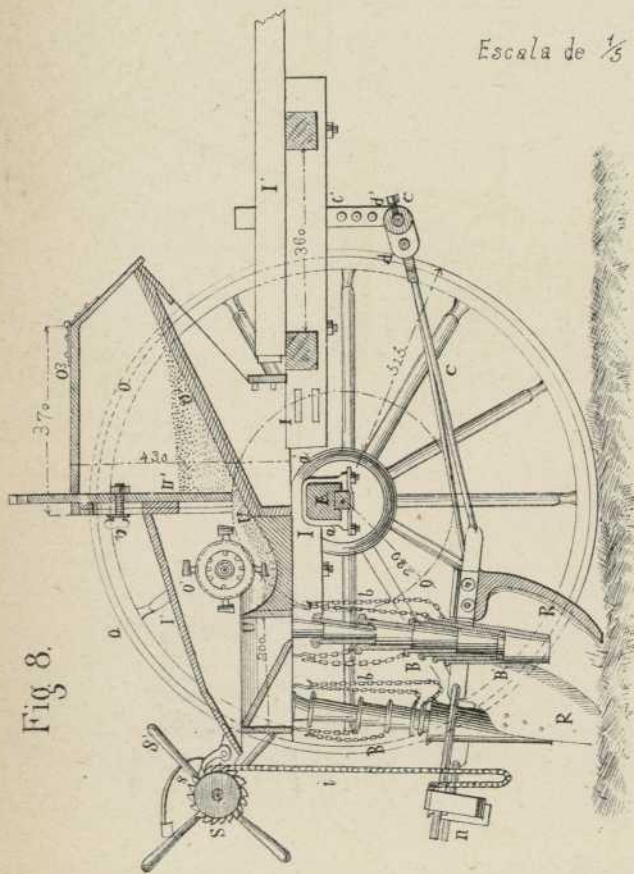
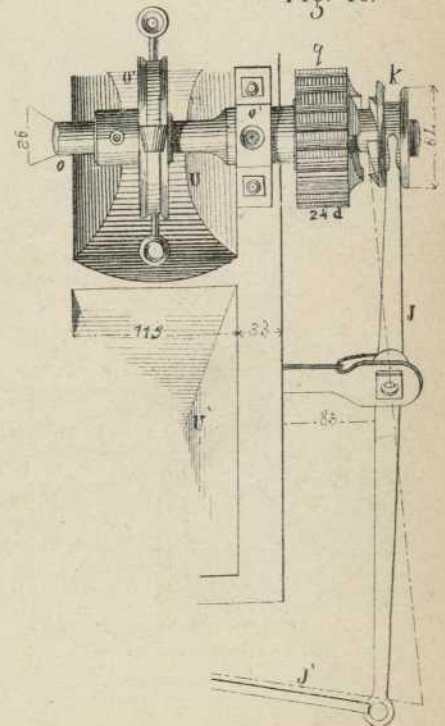
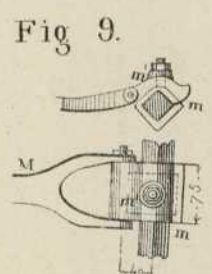
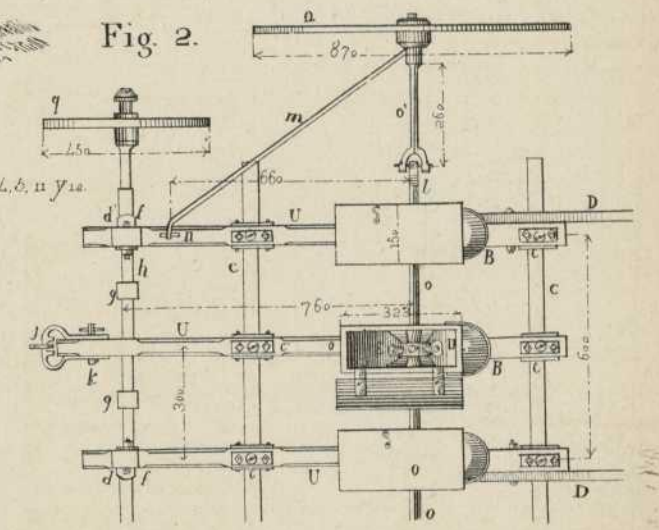
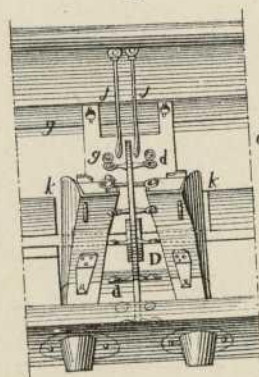
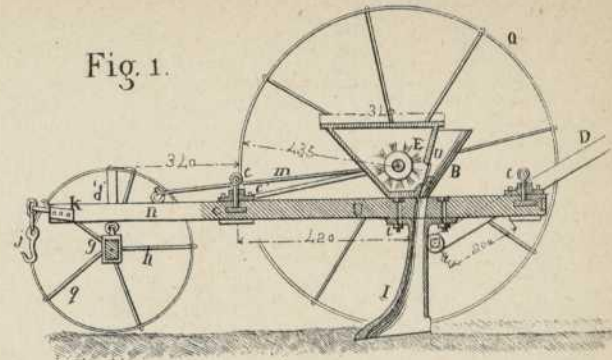
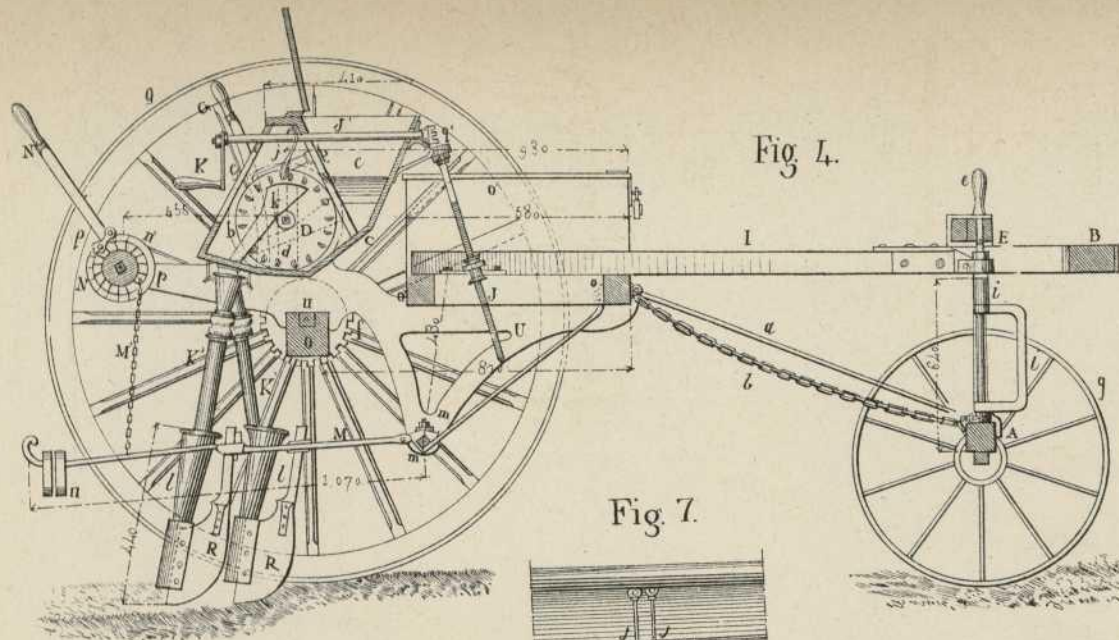


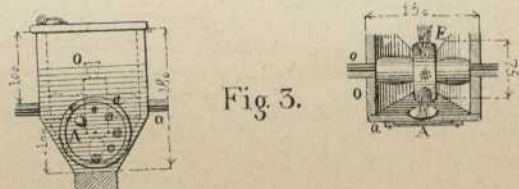
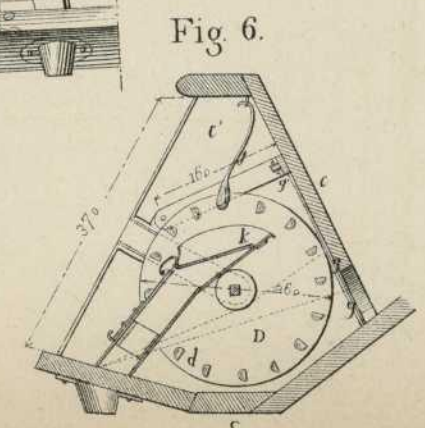
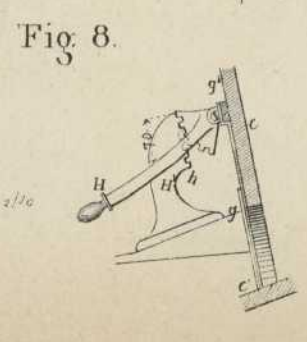
Fig 8.

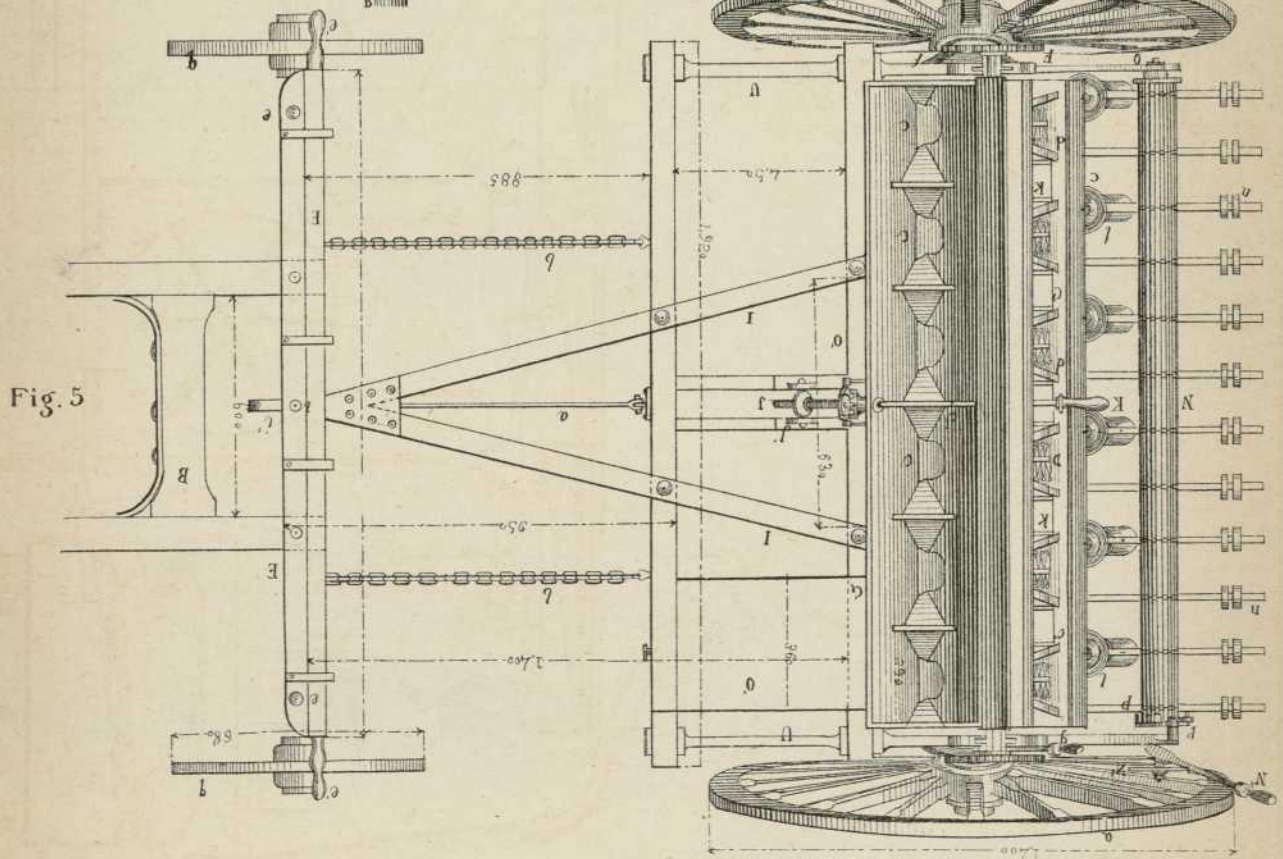
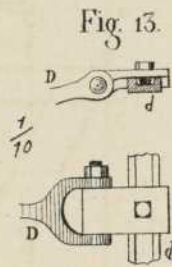
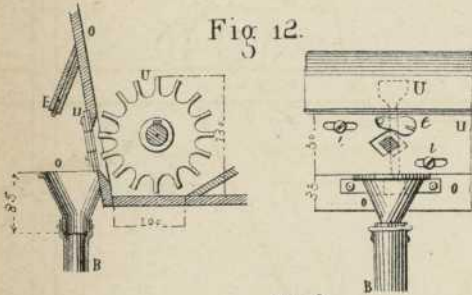
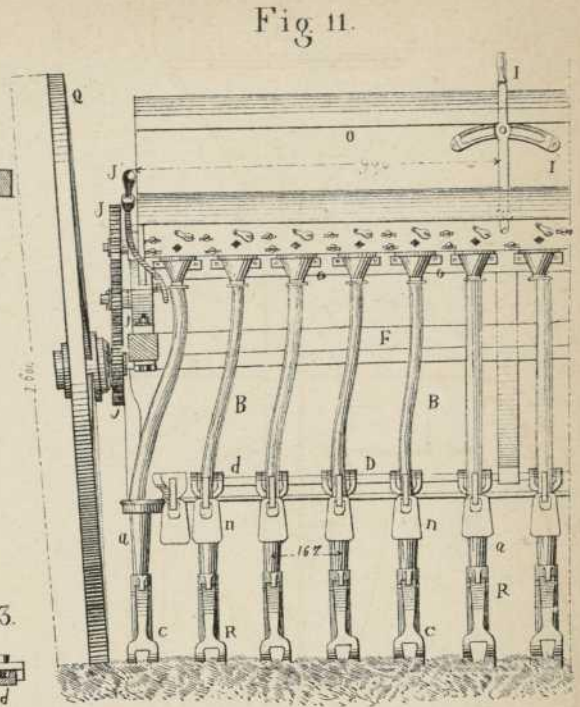
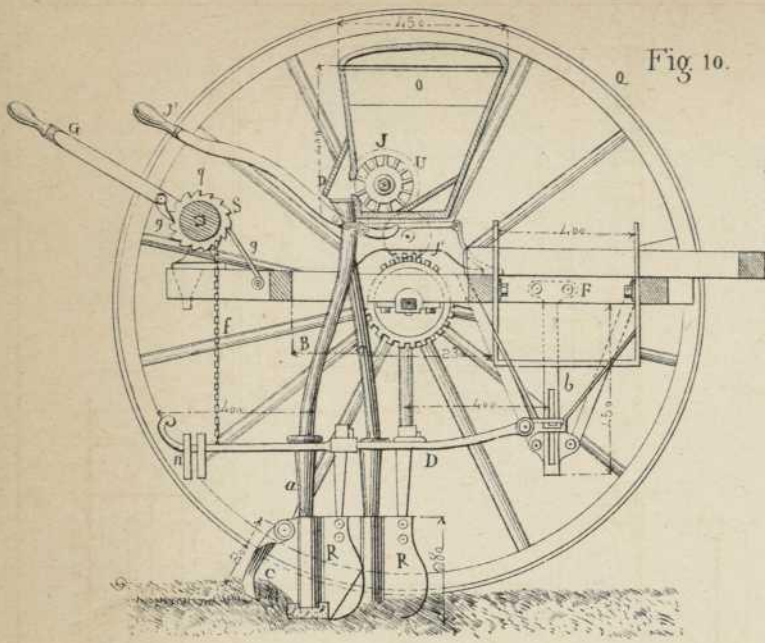
Fig 10.





Escala de 1/2 por las Fig. 1, 2, 4, 6, 7 y 10.





AR

Fig. 1.

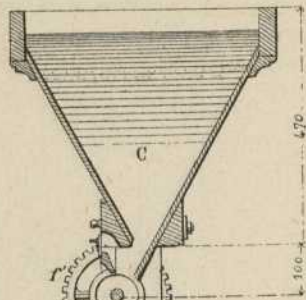
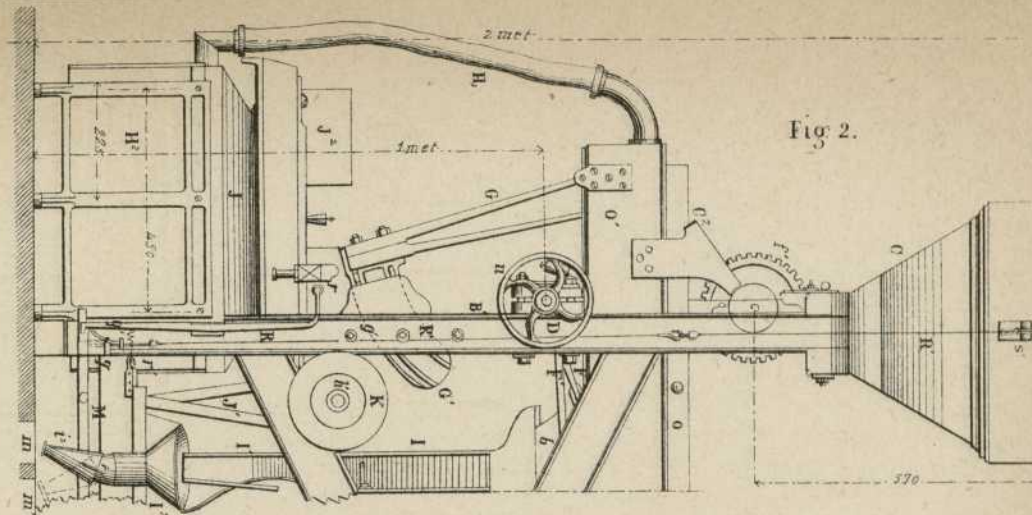


Fig. 2.



Longitud. total. 2,470

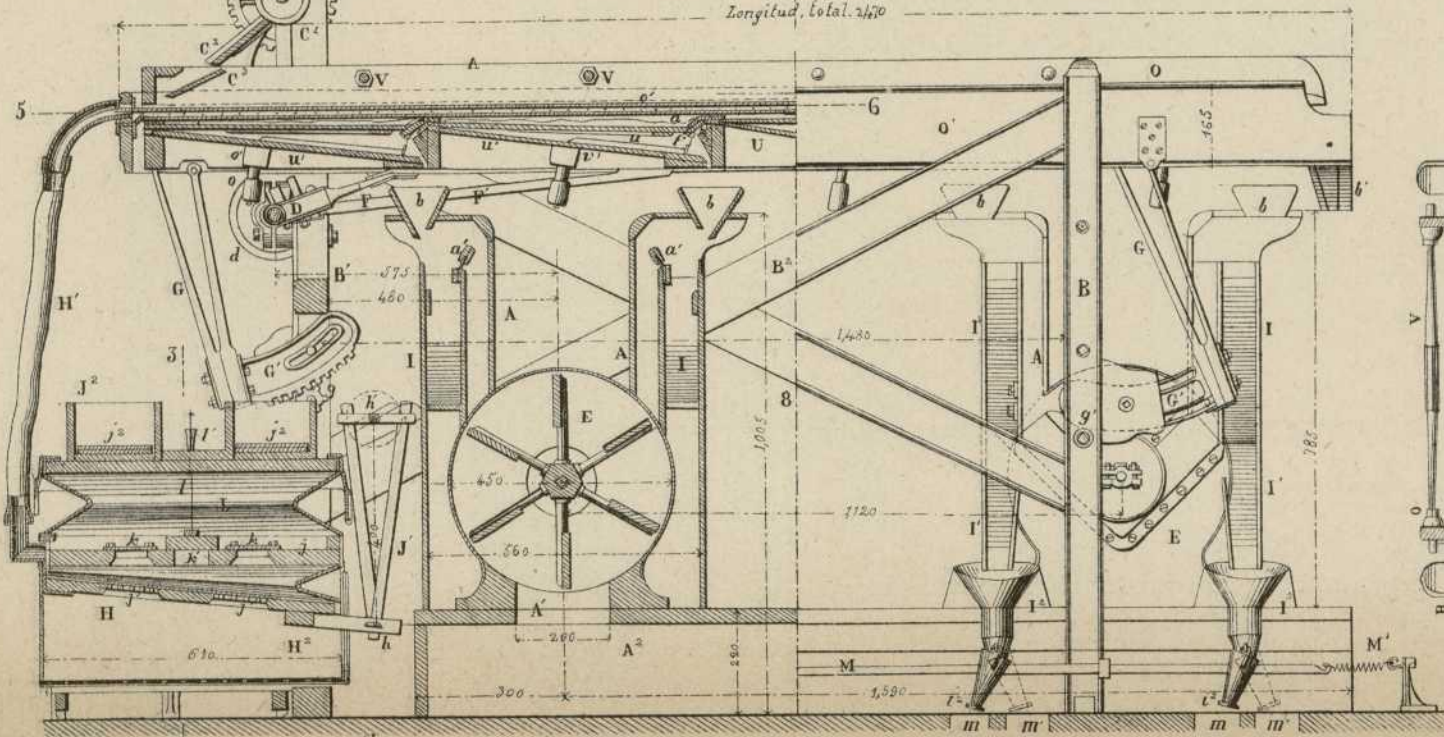
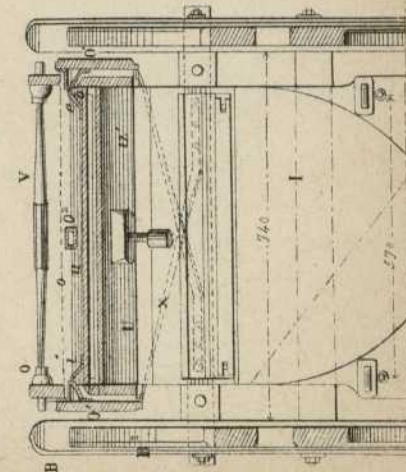


Fig. 5.



Escala de 1/5

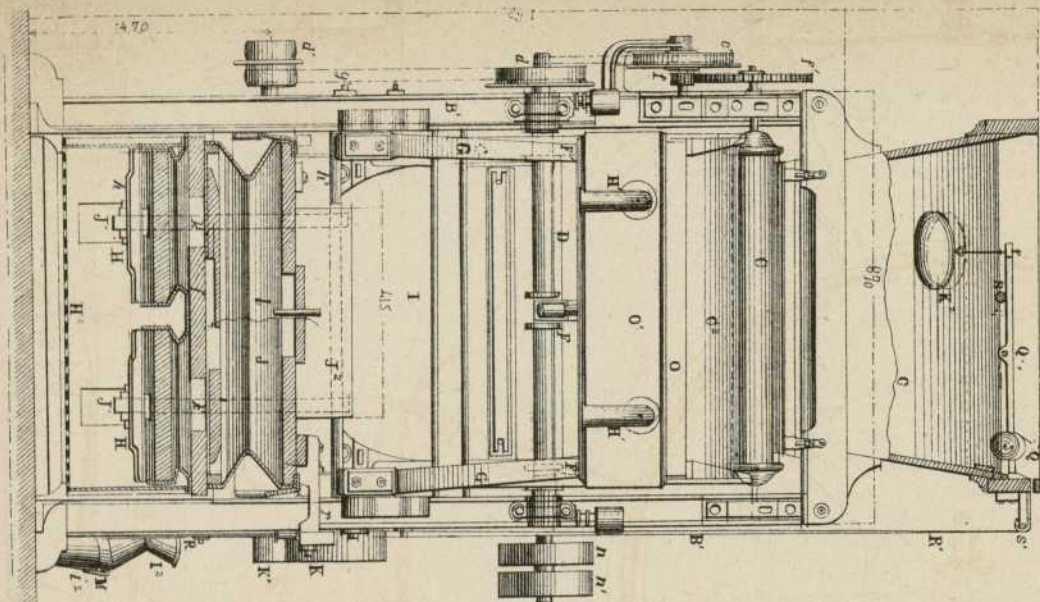


Fig. 5.

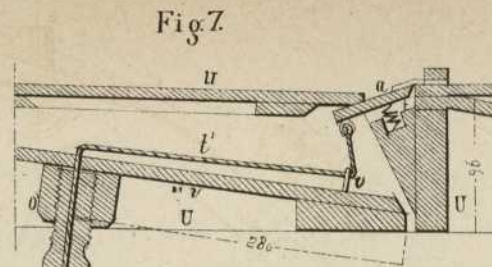


Fig. 7.

Fig. 6.

Escala de 1/6

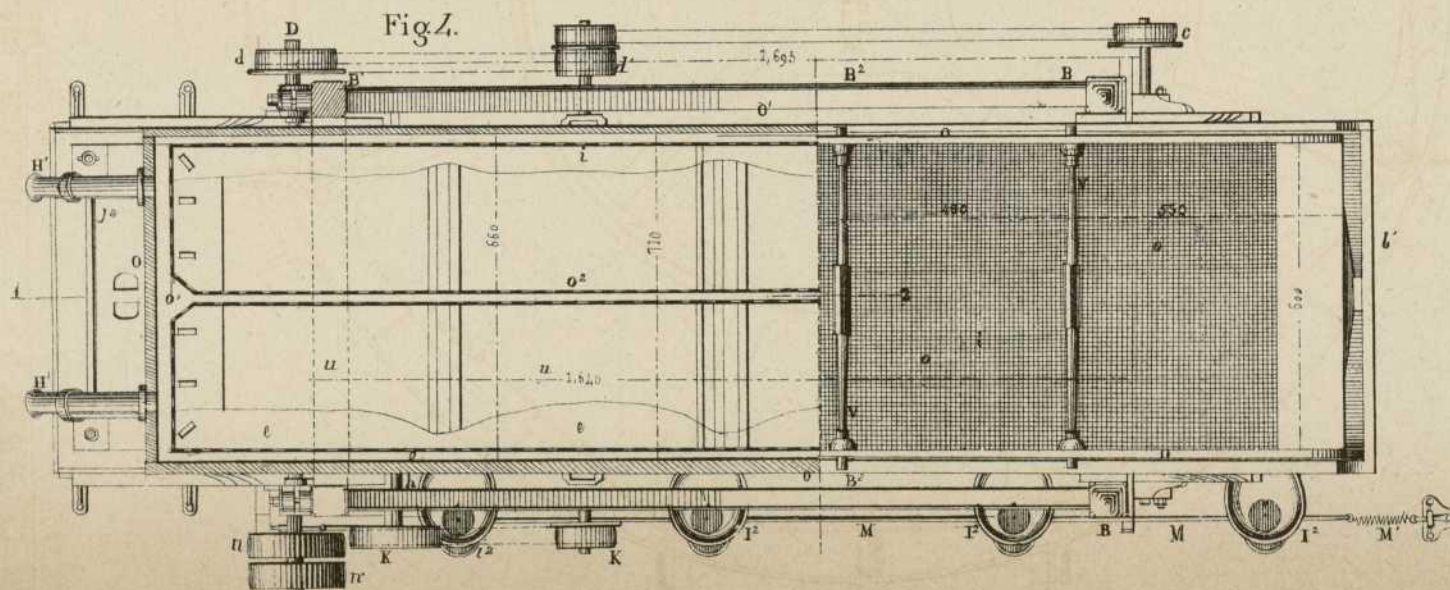
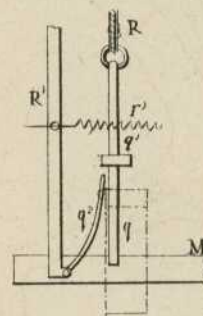


Fig. 4.

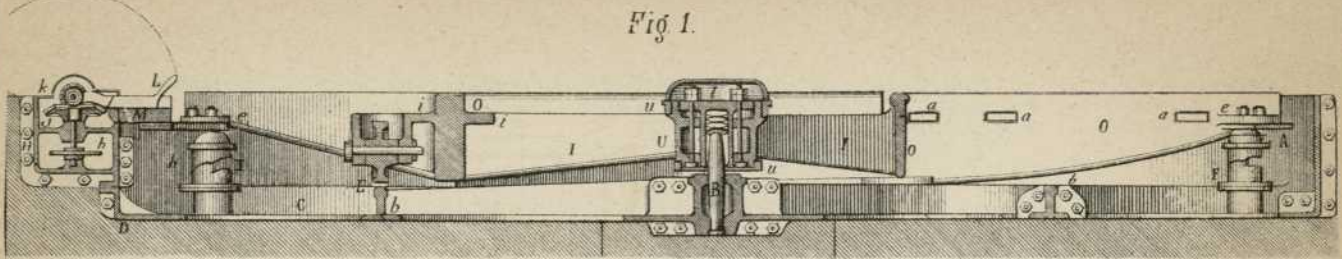


Fig. 1.

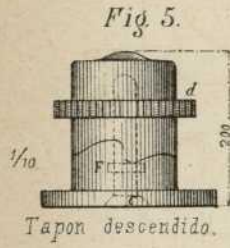


Fig. 5.

Tapon descendido.

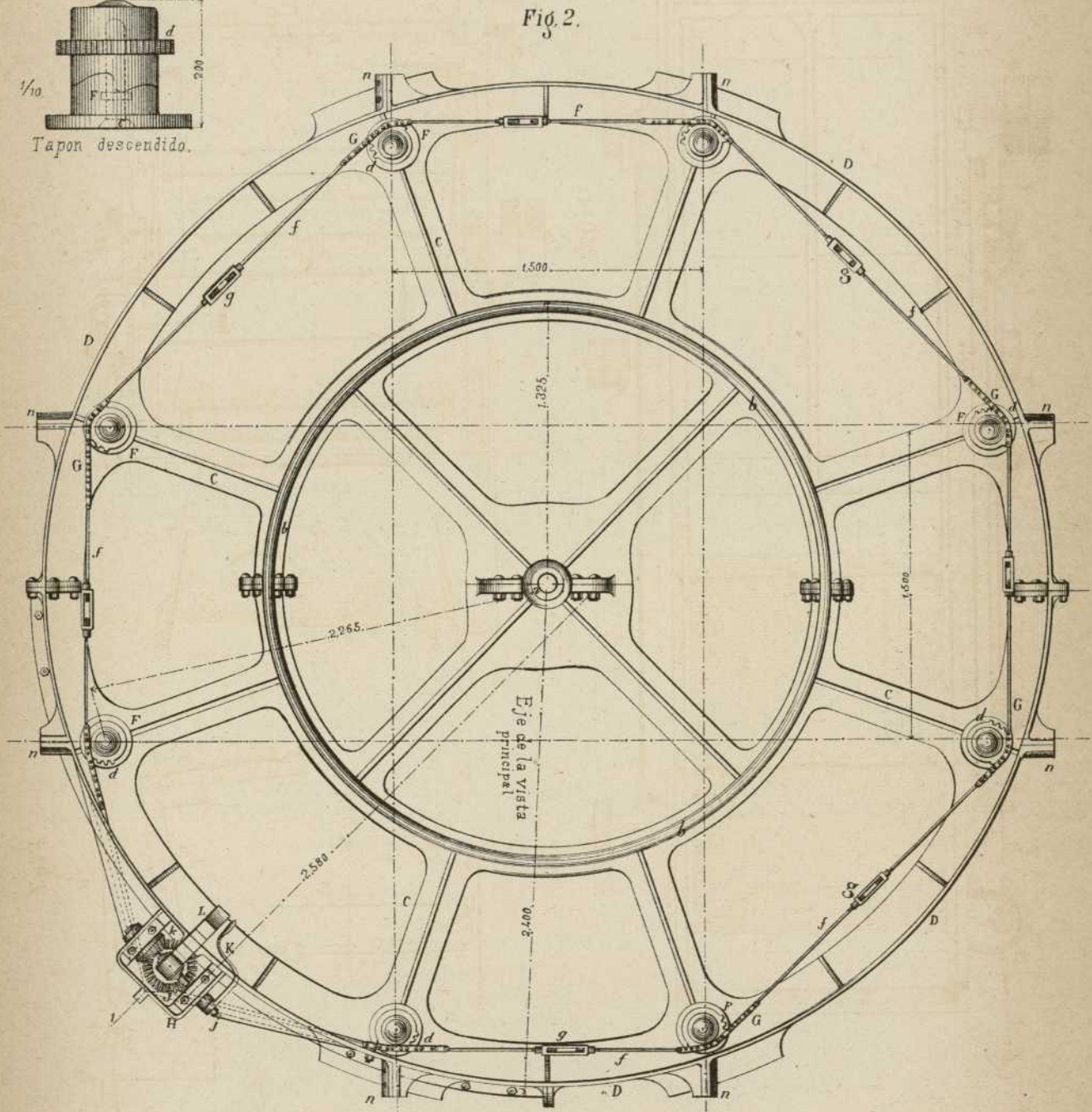


Fig. 2.

Escala de 1/30.

Fig. 3.

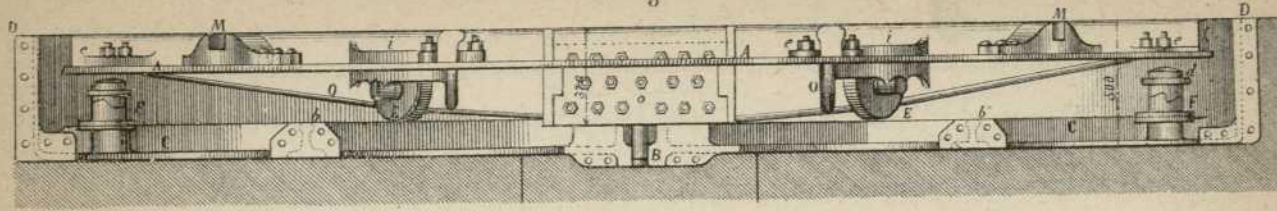


Fig. 7.

Tapon de calado desarrollado.

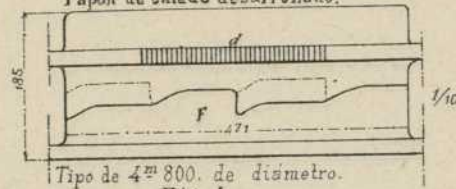


Fig. 4.

Fig. 6.

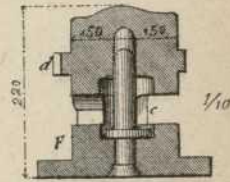


Fig. 9.

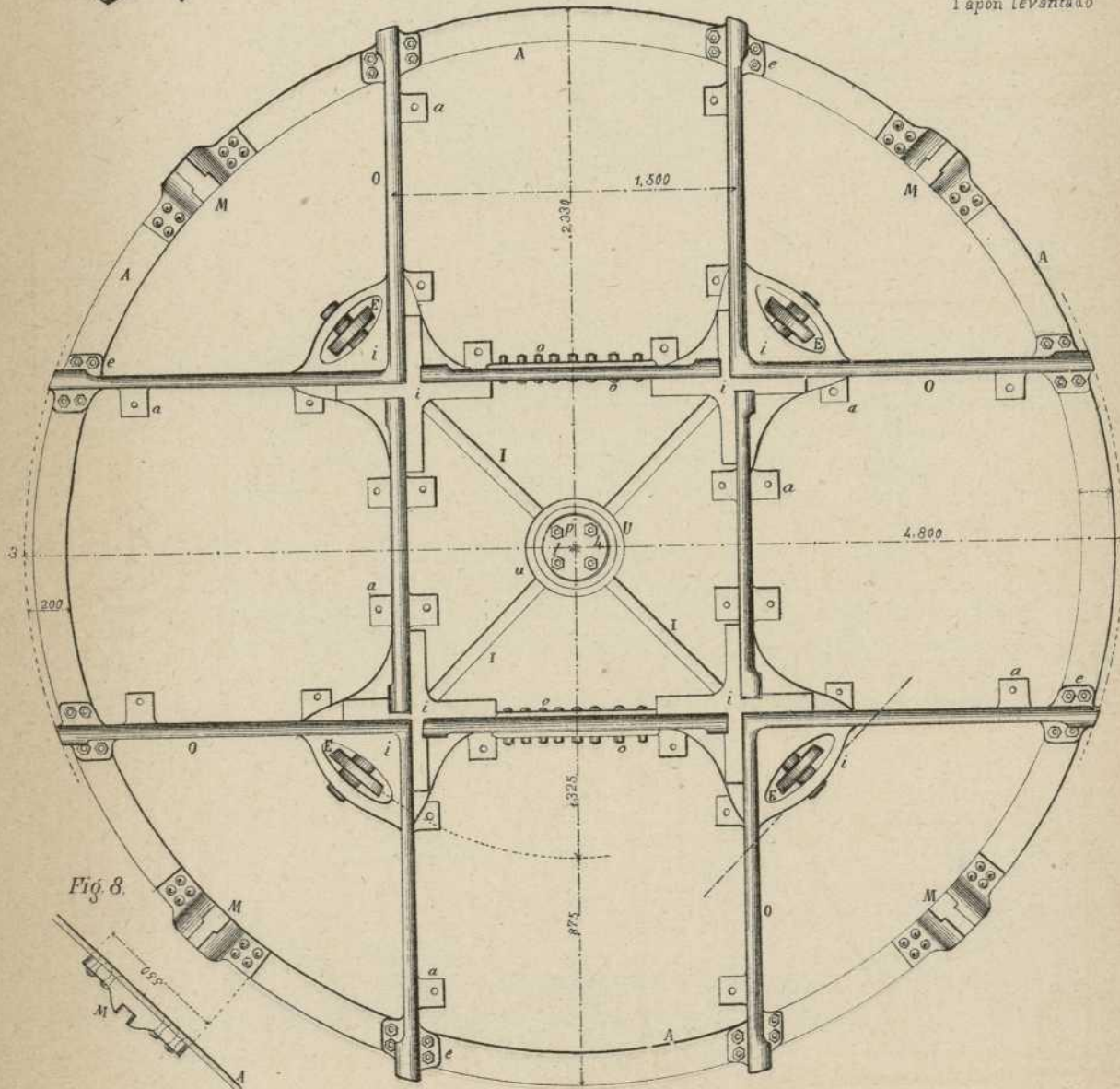
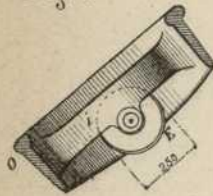
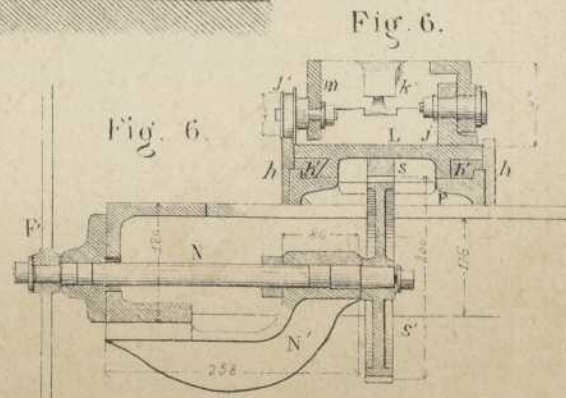
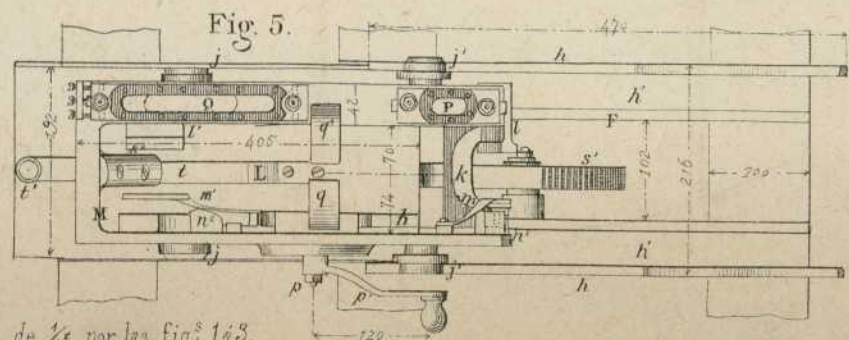
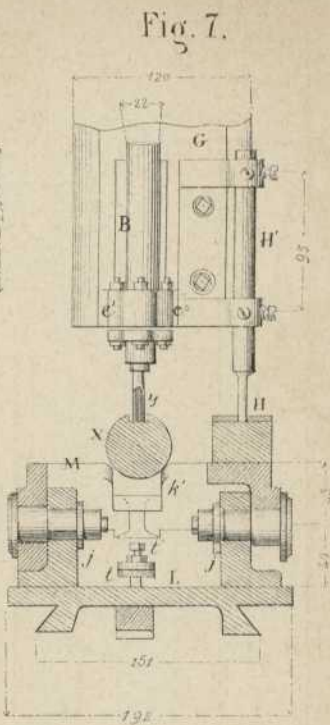
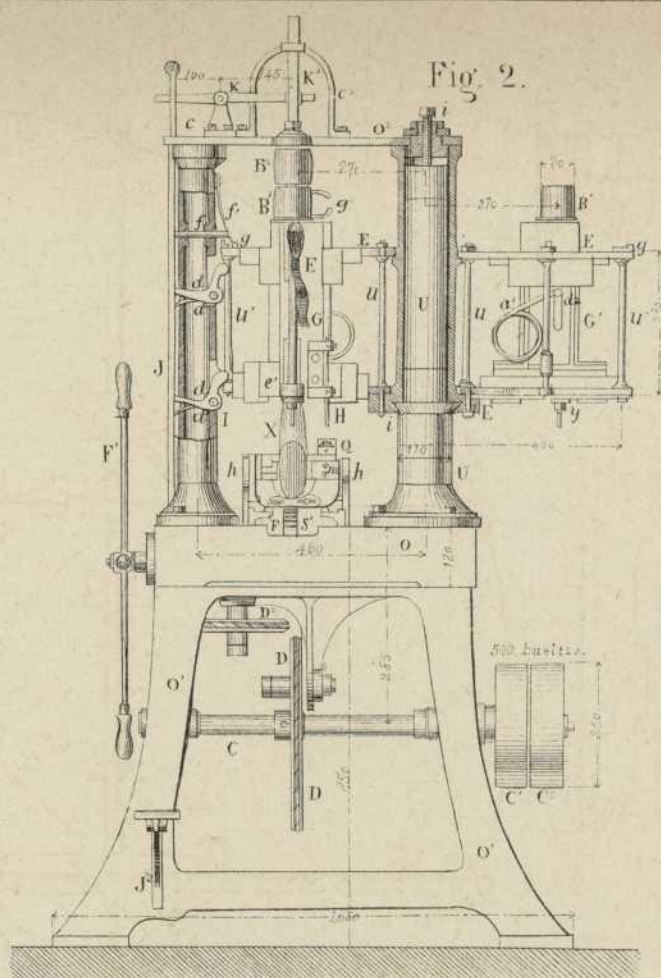
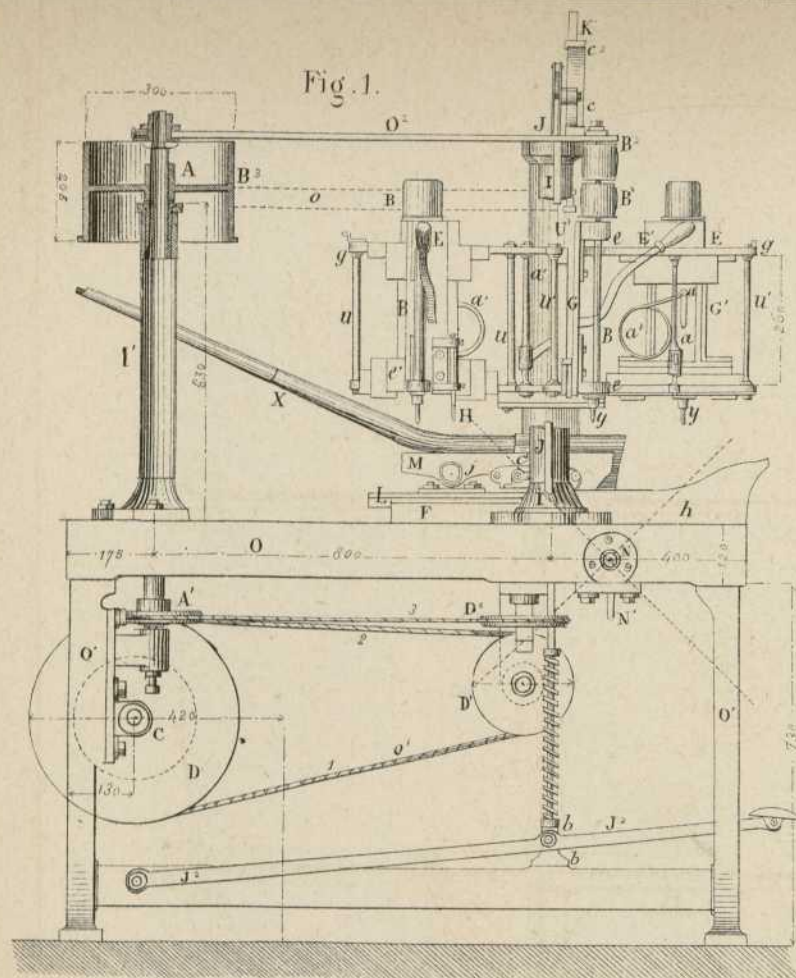
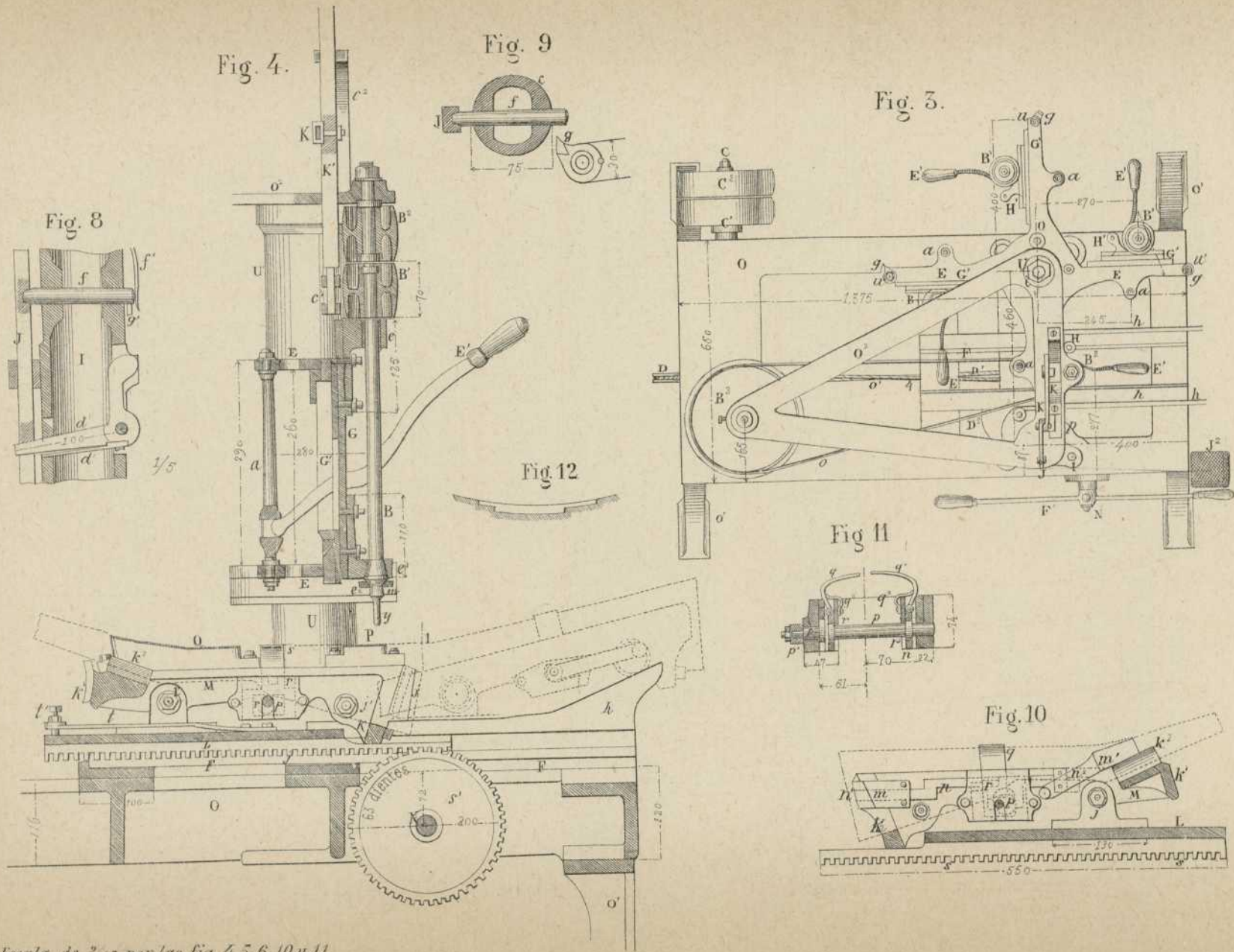


Fig. 8.

Escala de 1/30.



Escala de 1/4s. por las figs 1 a 3.



Escala de 2/15 por las fig 4 5.6.10 y 11

Fig. 1.

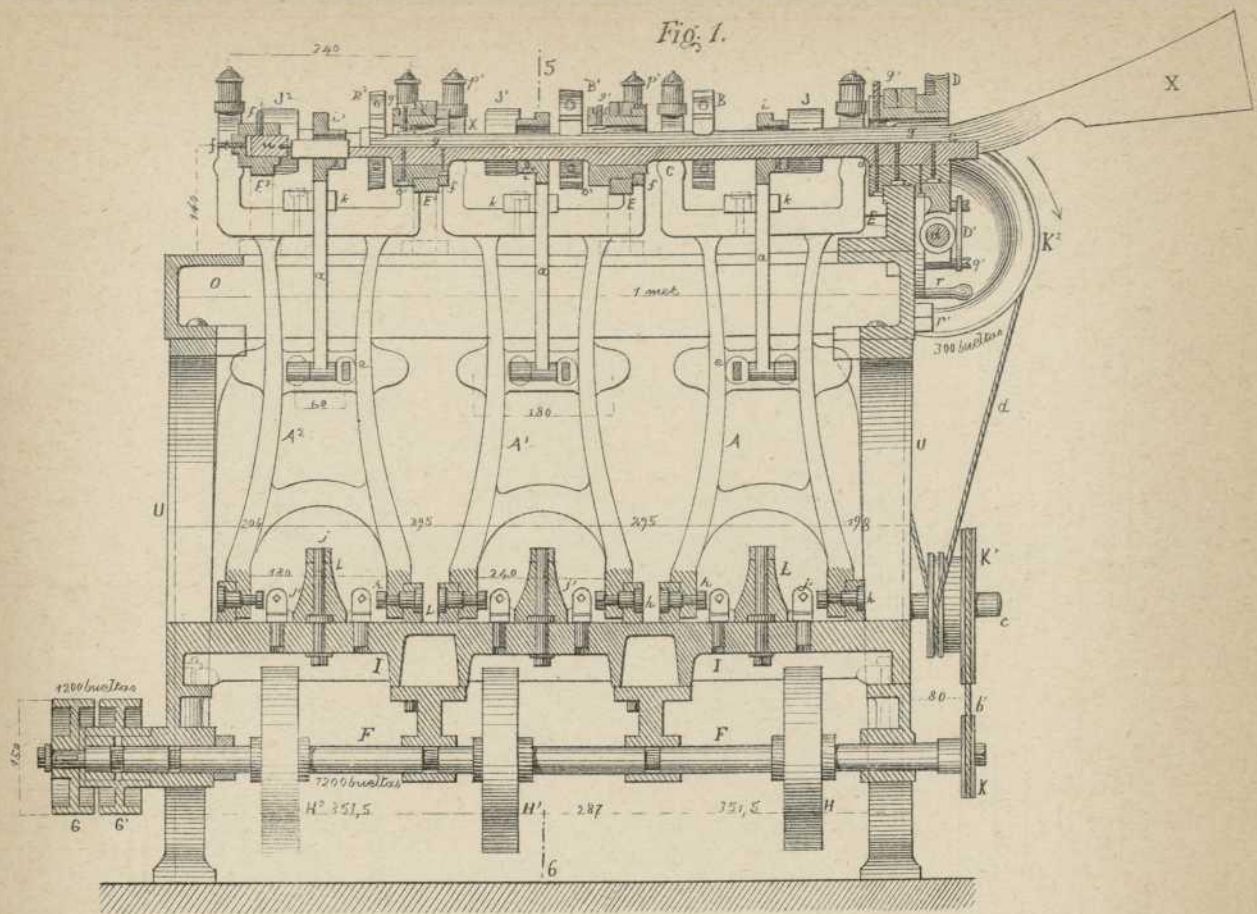


Fig. 2.

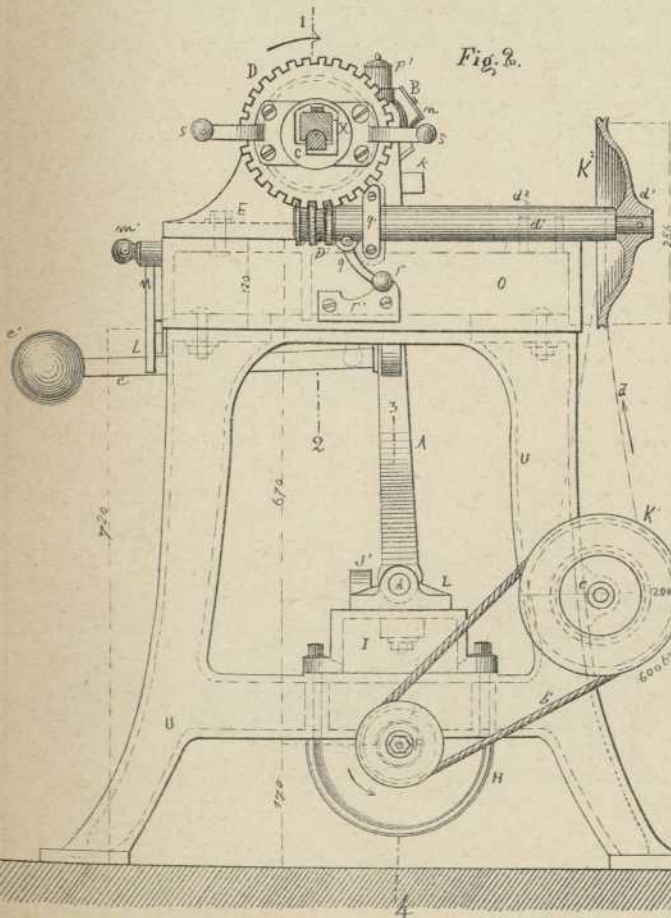
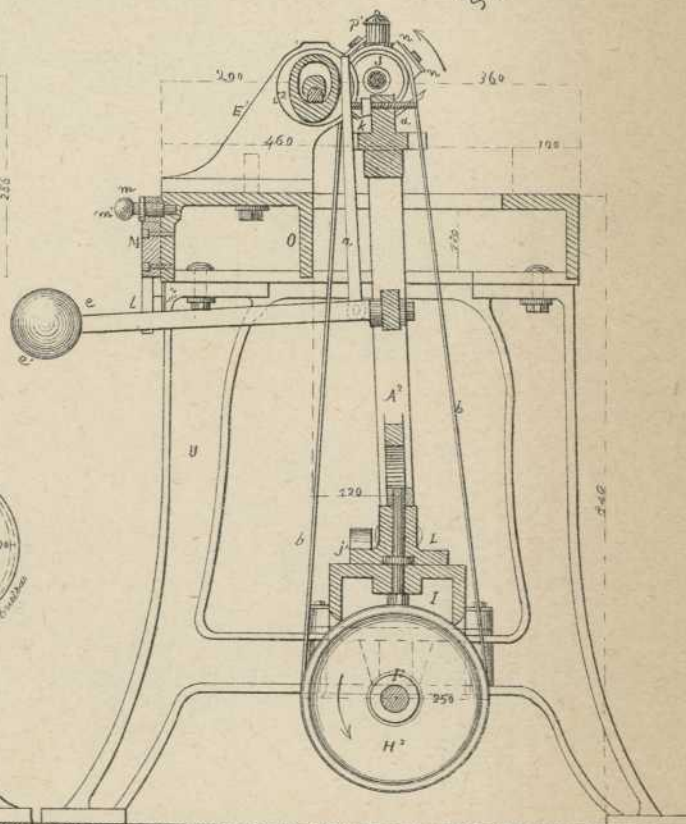
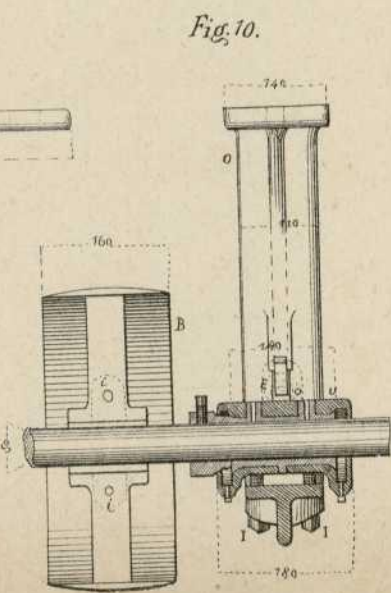
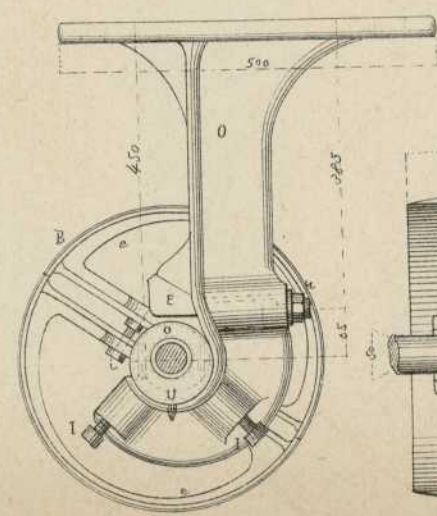
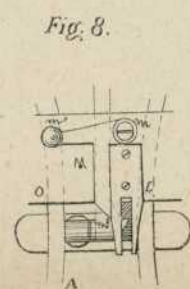
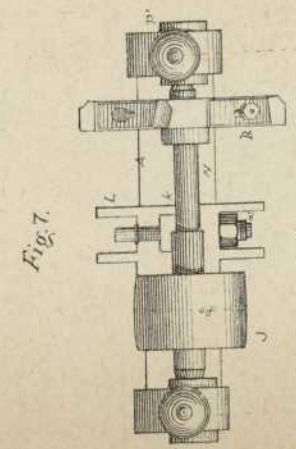
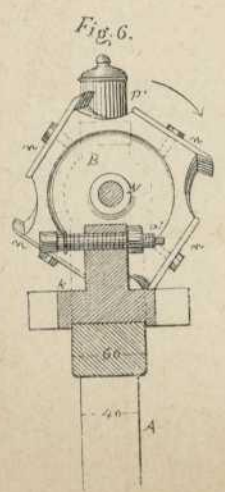
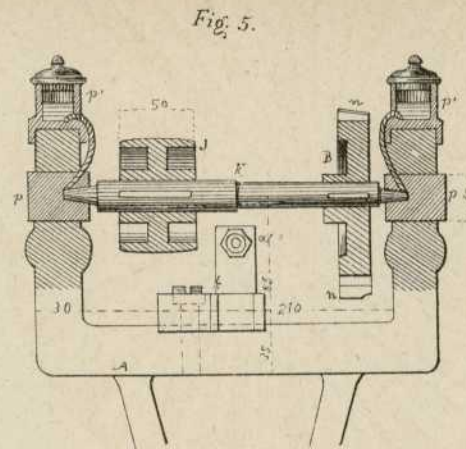
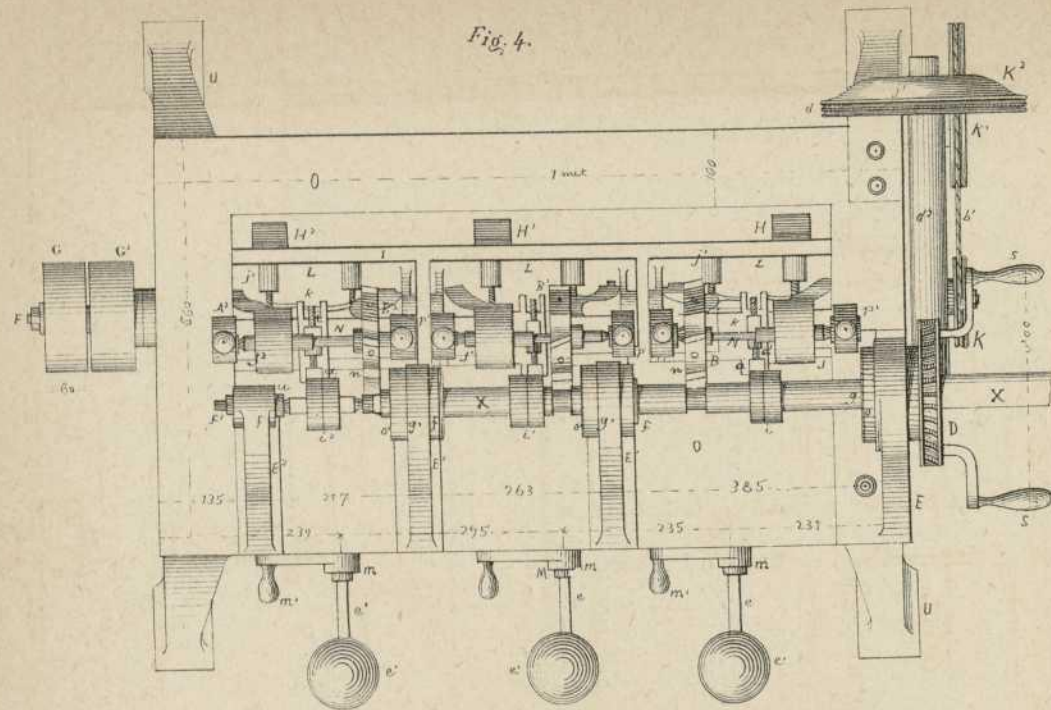


Fig. 3.



Escala de $\frac{1}{10}$ por las figs 164, 8 y 10



Escala de 1/2 por las fig. 1 a 7

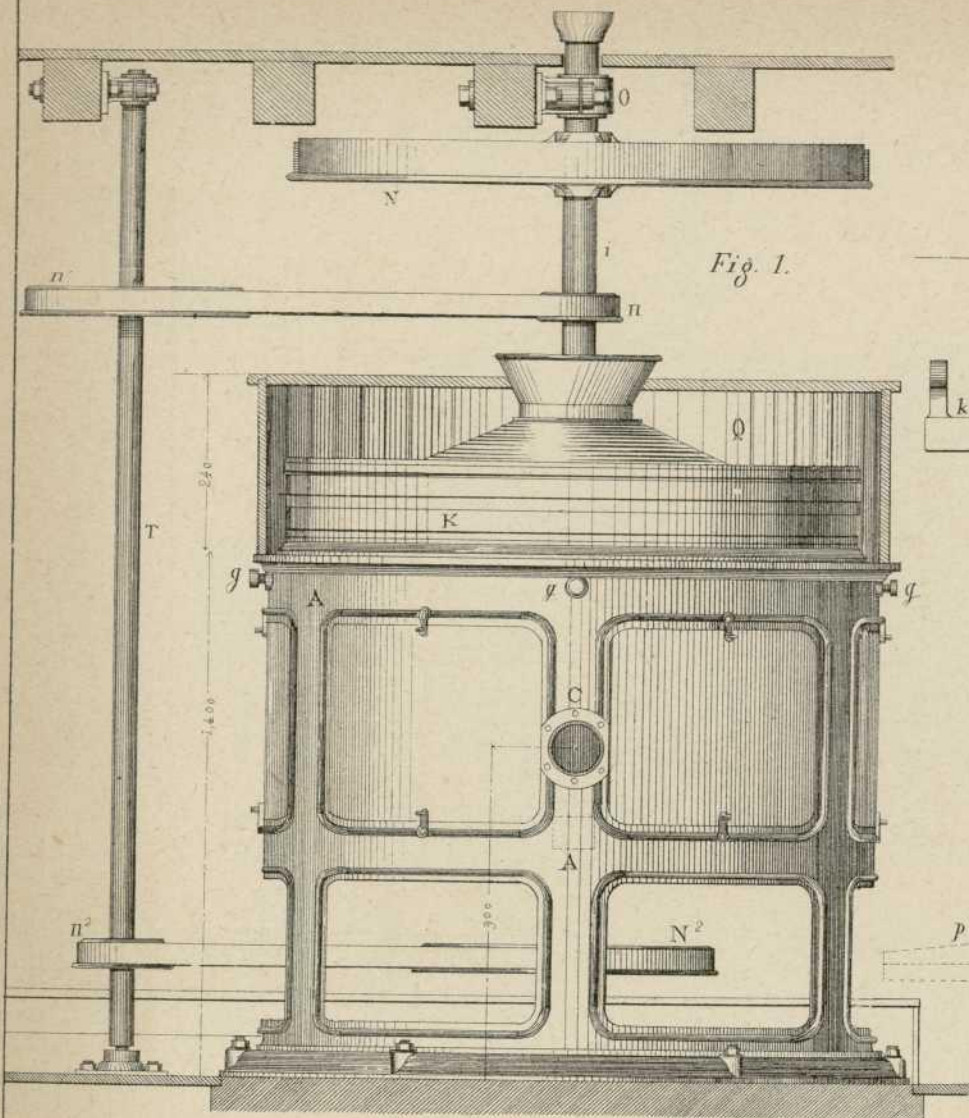


Fig. 1.

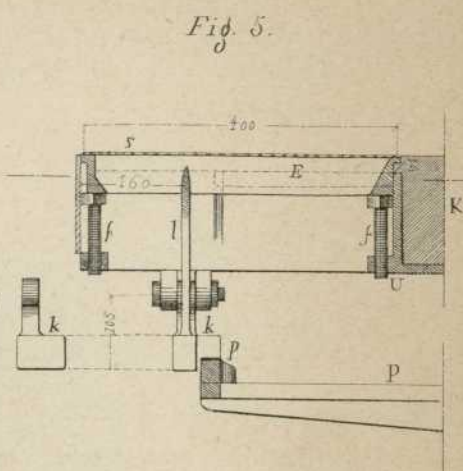


Fig. 5.

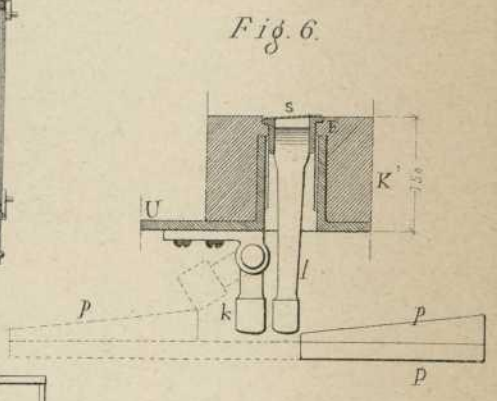


Fig. 6.

Fig. 2.

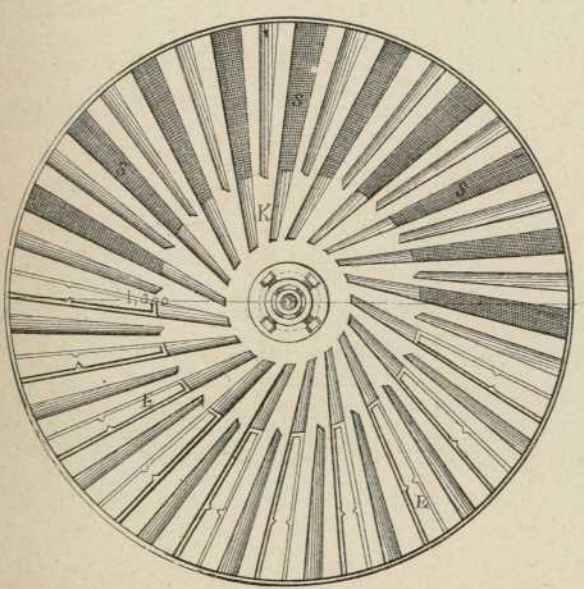
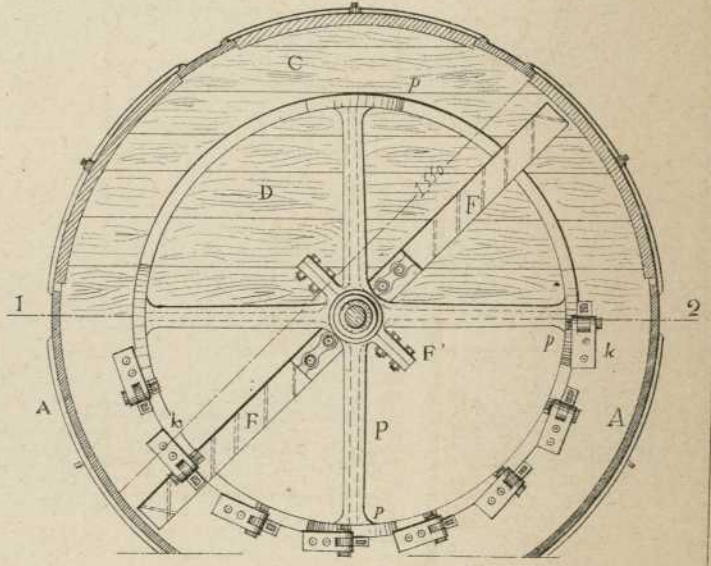


Fig. 4.



Escala de 1/20 por las figs 1 & 4

Ⓔ

Fig. 3.

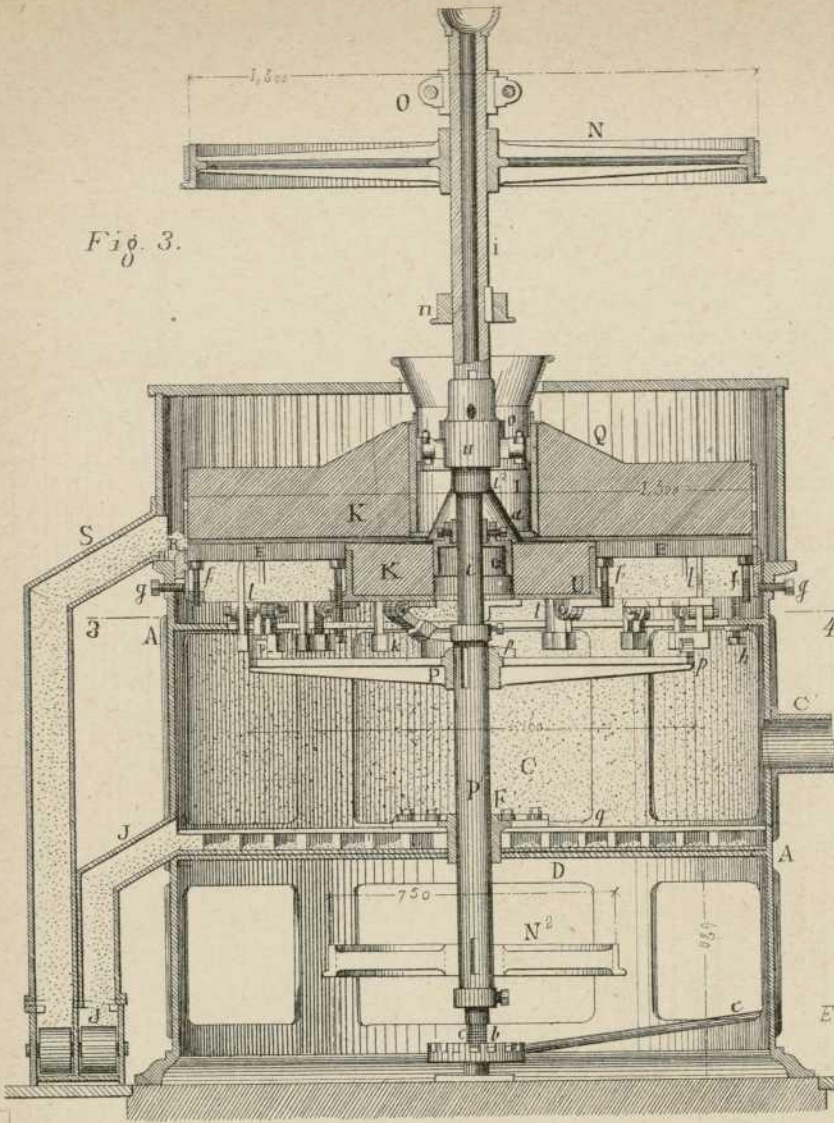


Fig. 10.

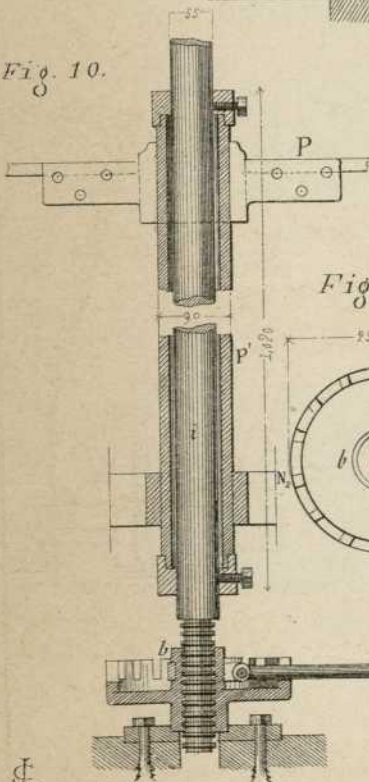


Fig. 7.

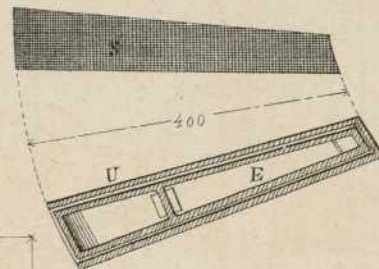


Fig. 11.

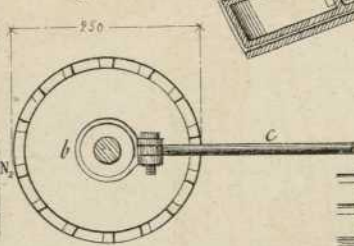
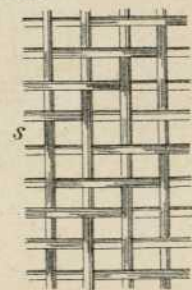


Fig. 12.



Escala de 1/3

Fig. 8.

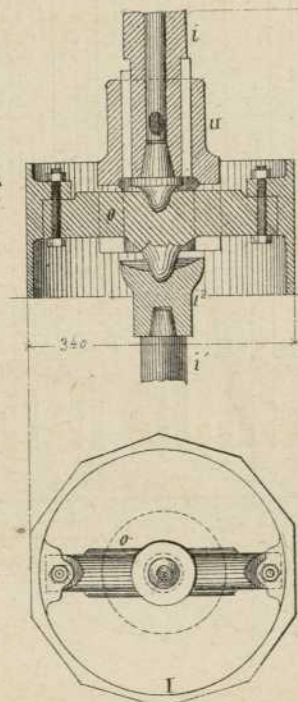


Fig. 9.



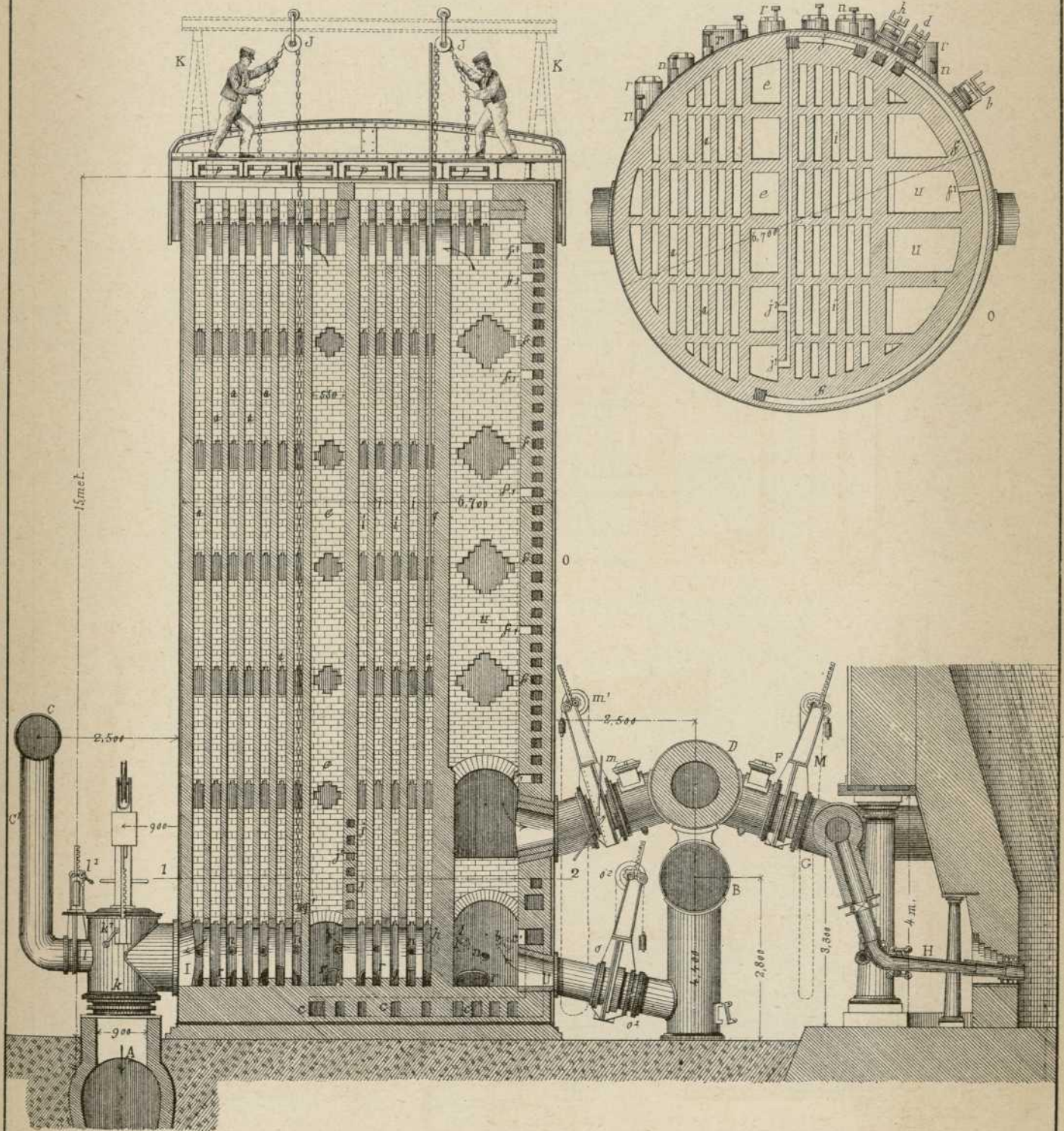
Fig. 1.

Corte vertical.

Escala de $\frac{1}{100}$

Fig. 2.

Corte horizontal por 1-2



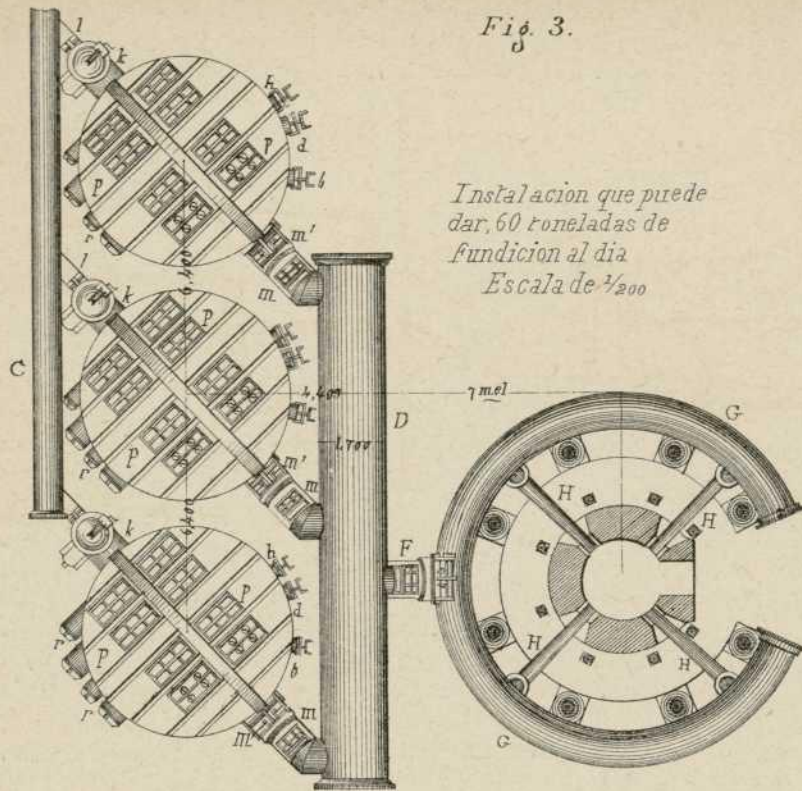
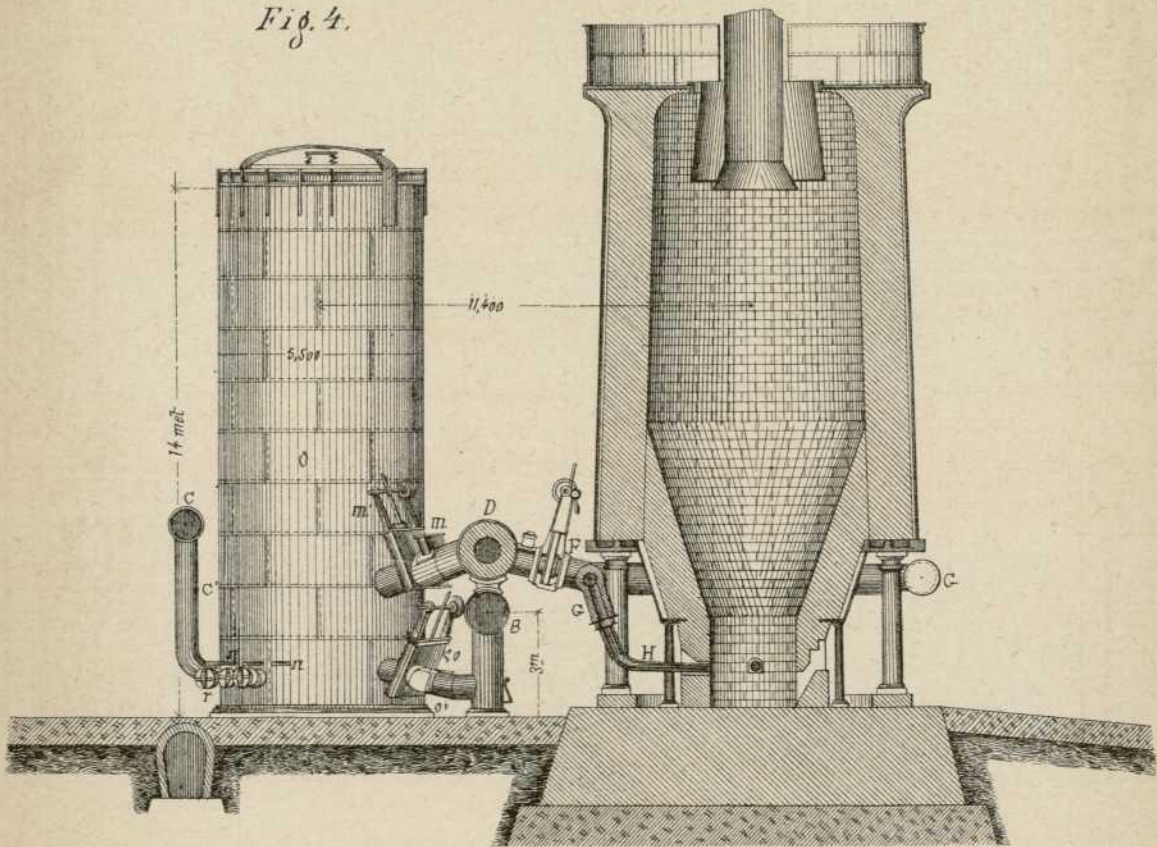


Fig. 3.

Instalacion que puede dar, 60 toneladas de fundicion al dia
Escala de $\frac{1}{200}$

Fig. 4.



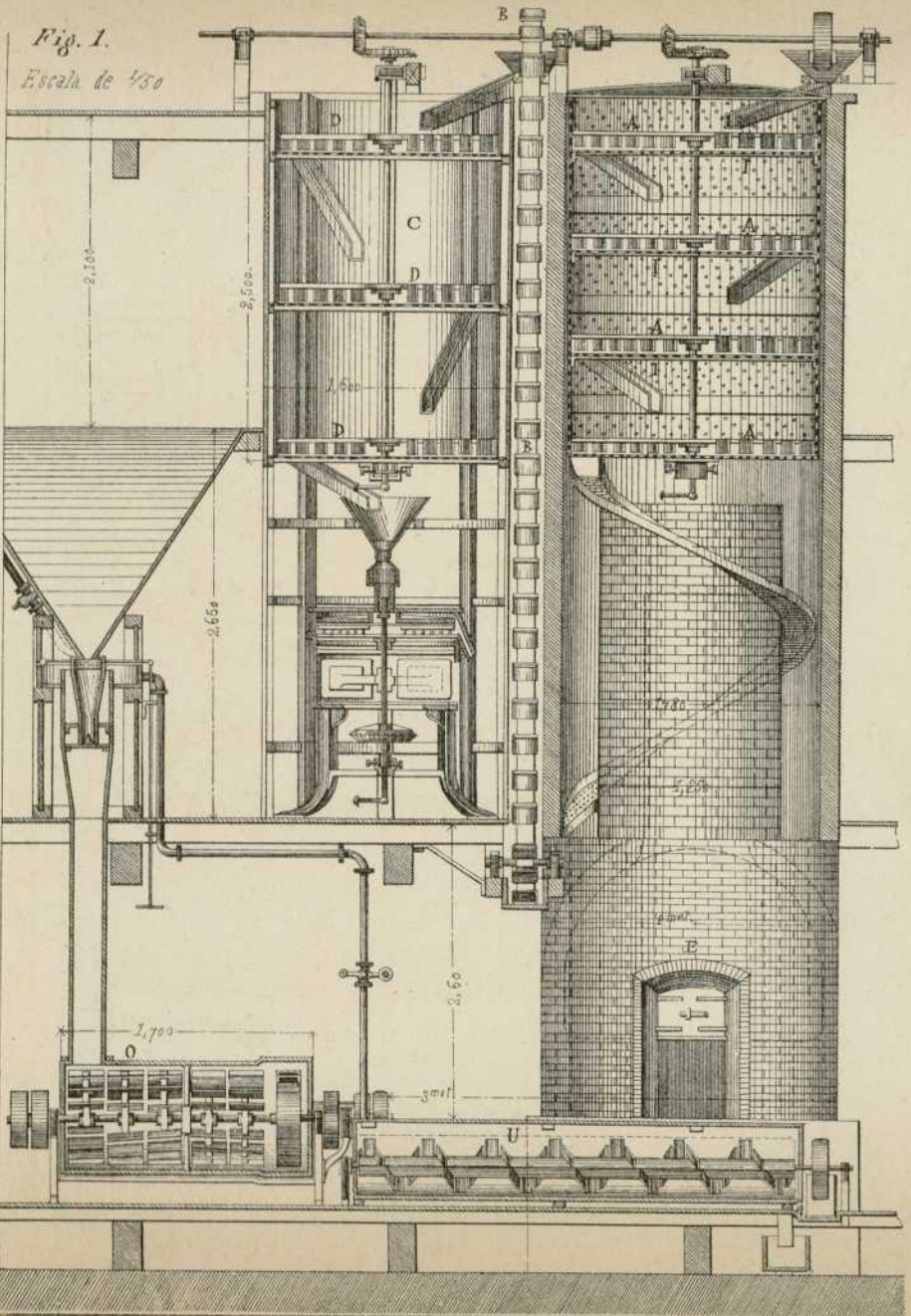
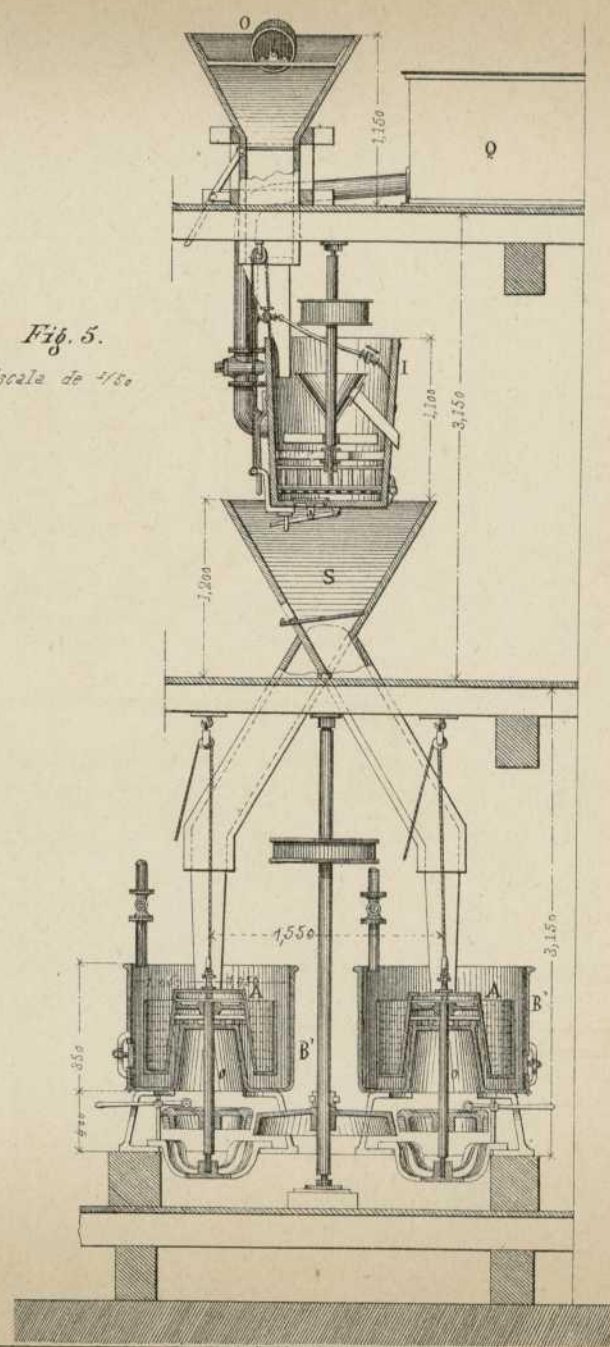


Fig. 5.
Escala de 1/50



Ⓕ.
Nacente, editor.

Paseo de Gracia, 119.

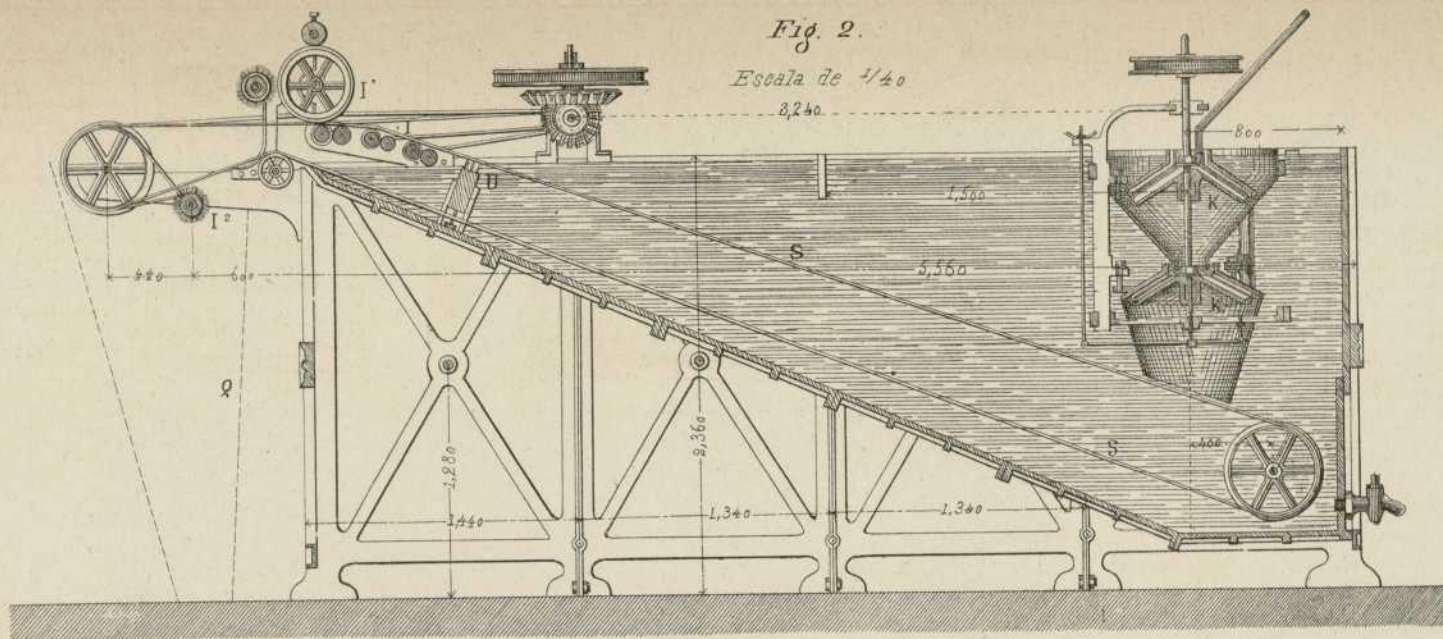


Fig. 3.

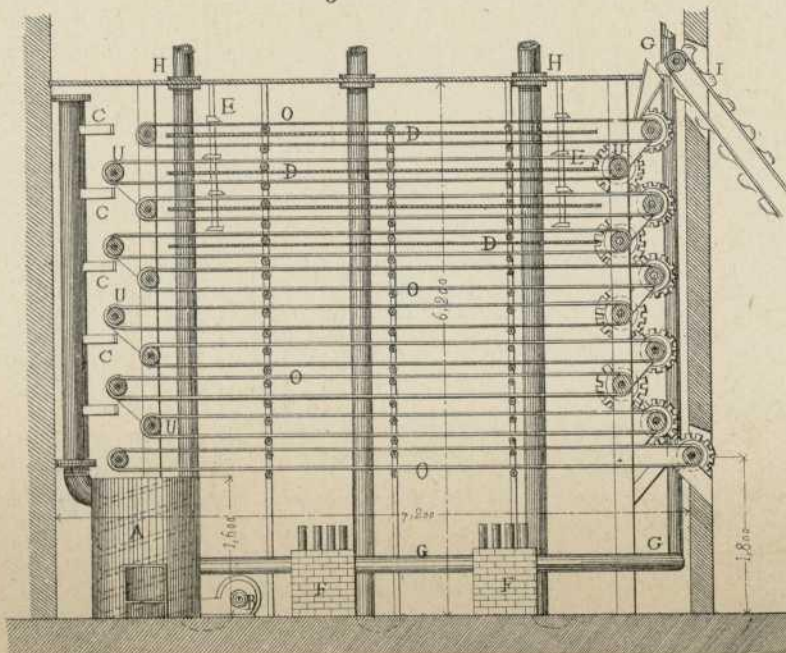
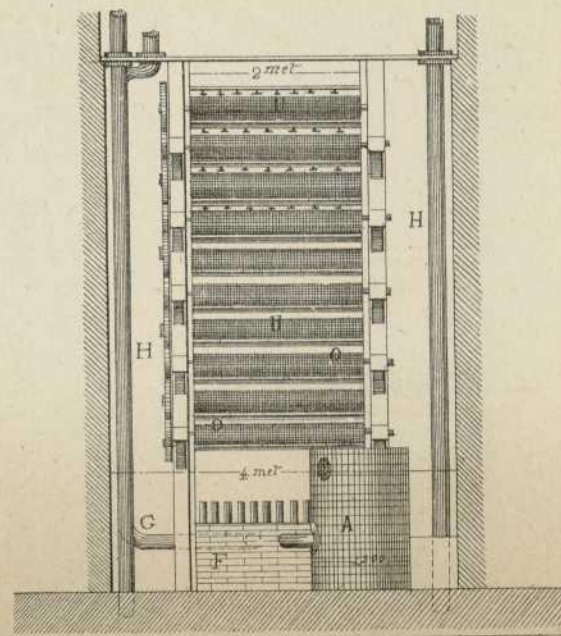


Fig. 4.



ϕ.

Fig. 1.

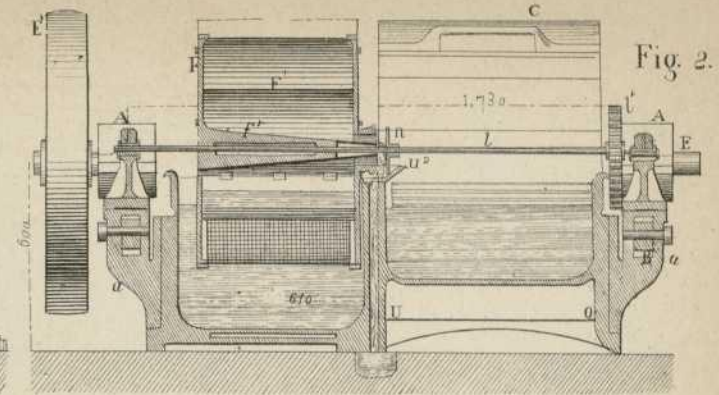
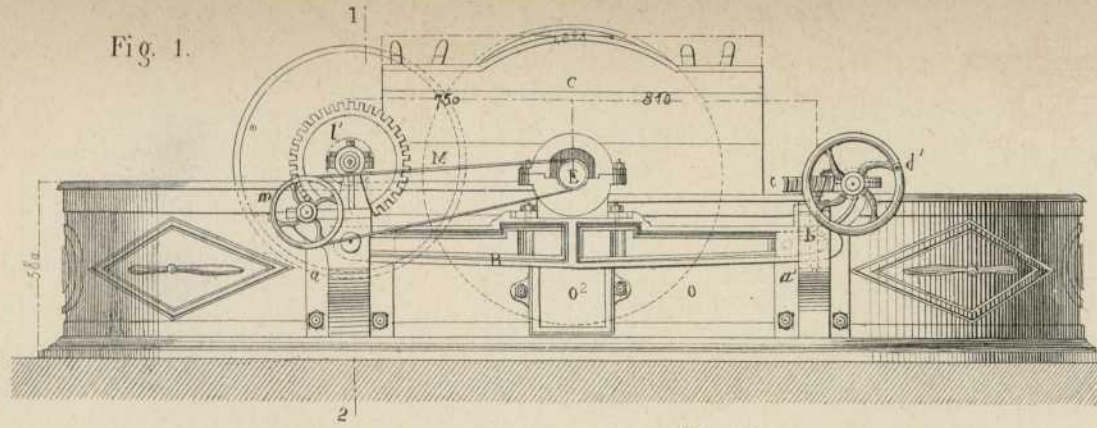


Fig. 3.

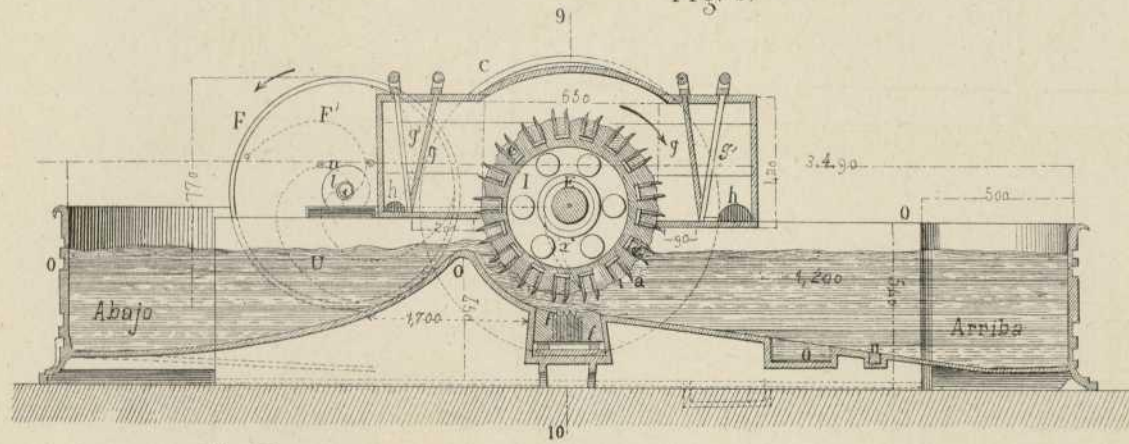


Fig. 7.

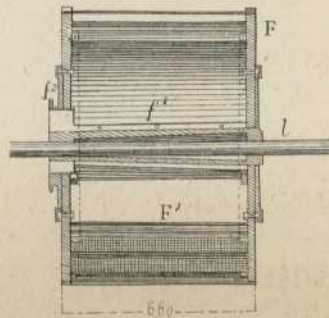


Fig. 6.

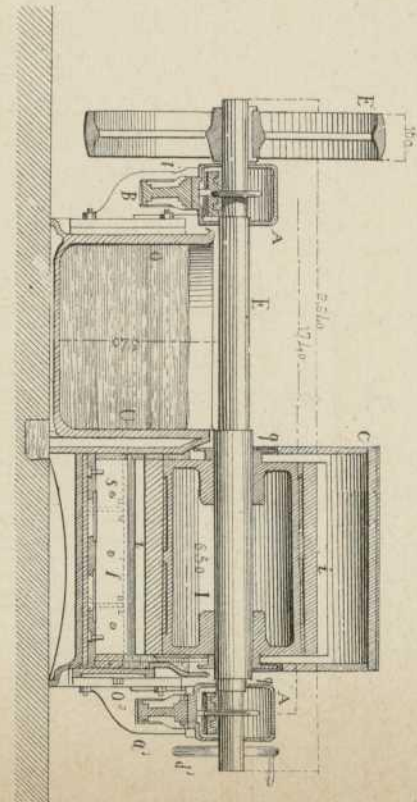
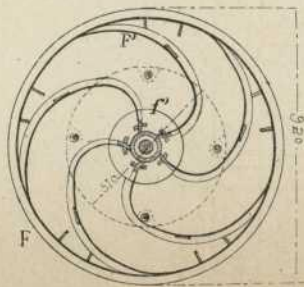


Fig. 4.

Fig 5.

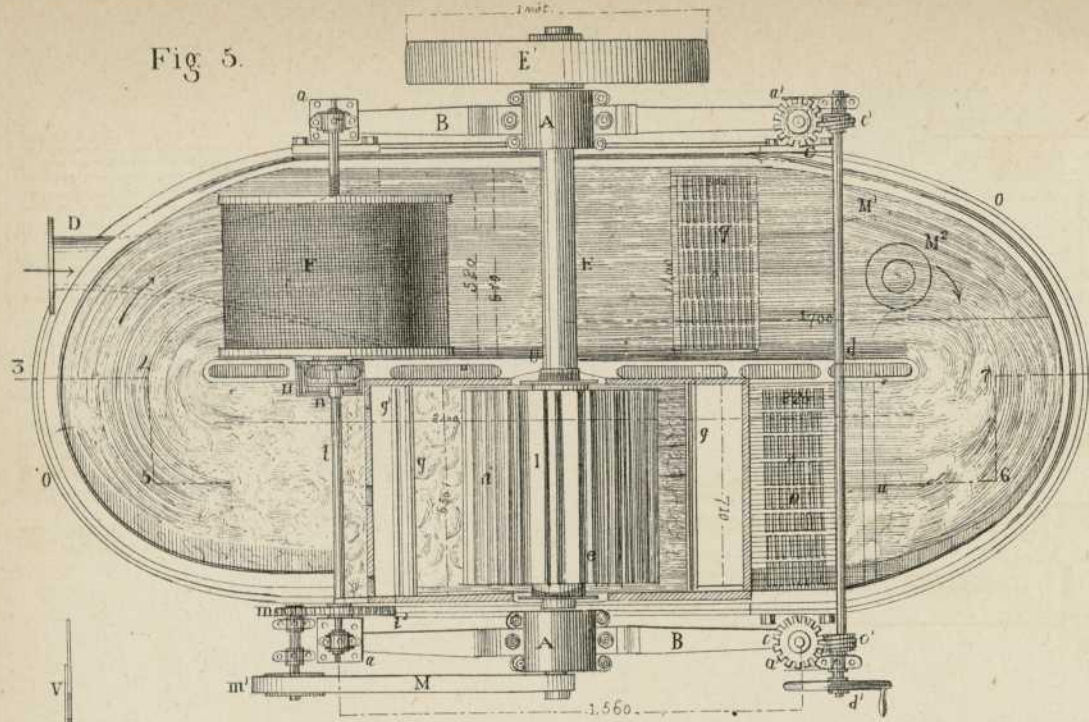
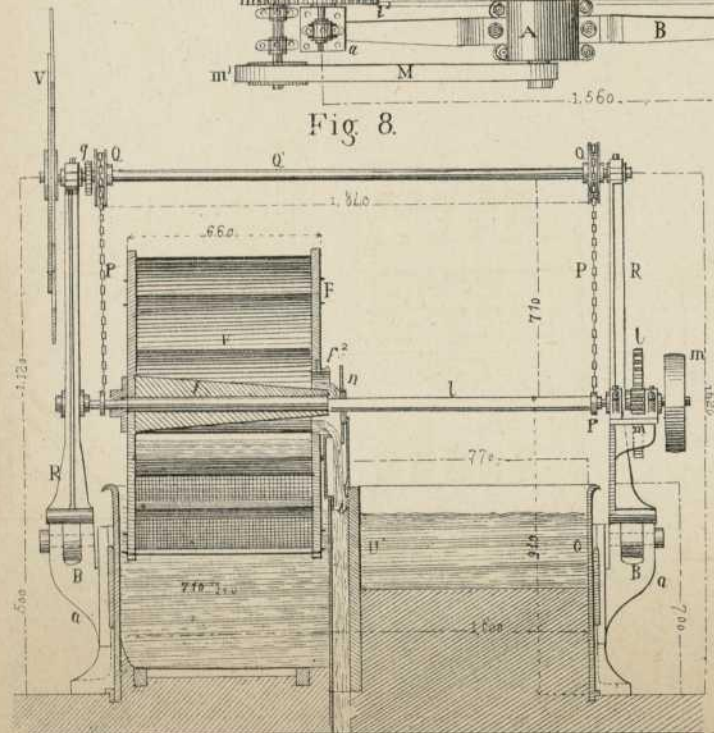


Fig 8.



Escala de $\frac{1}{25}$

Fig 13.

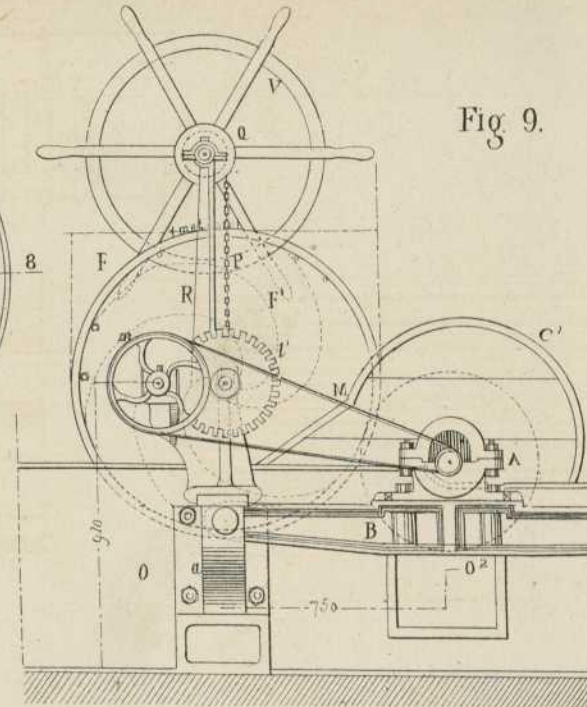
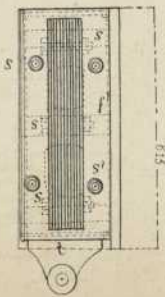


Fig 9.

Fig 12.



Fig 11.

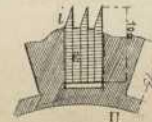
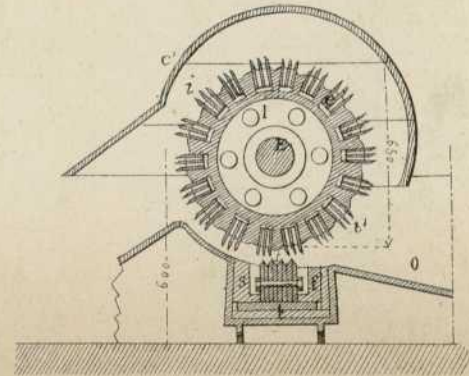


Fig 10.



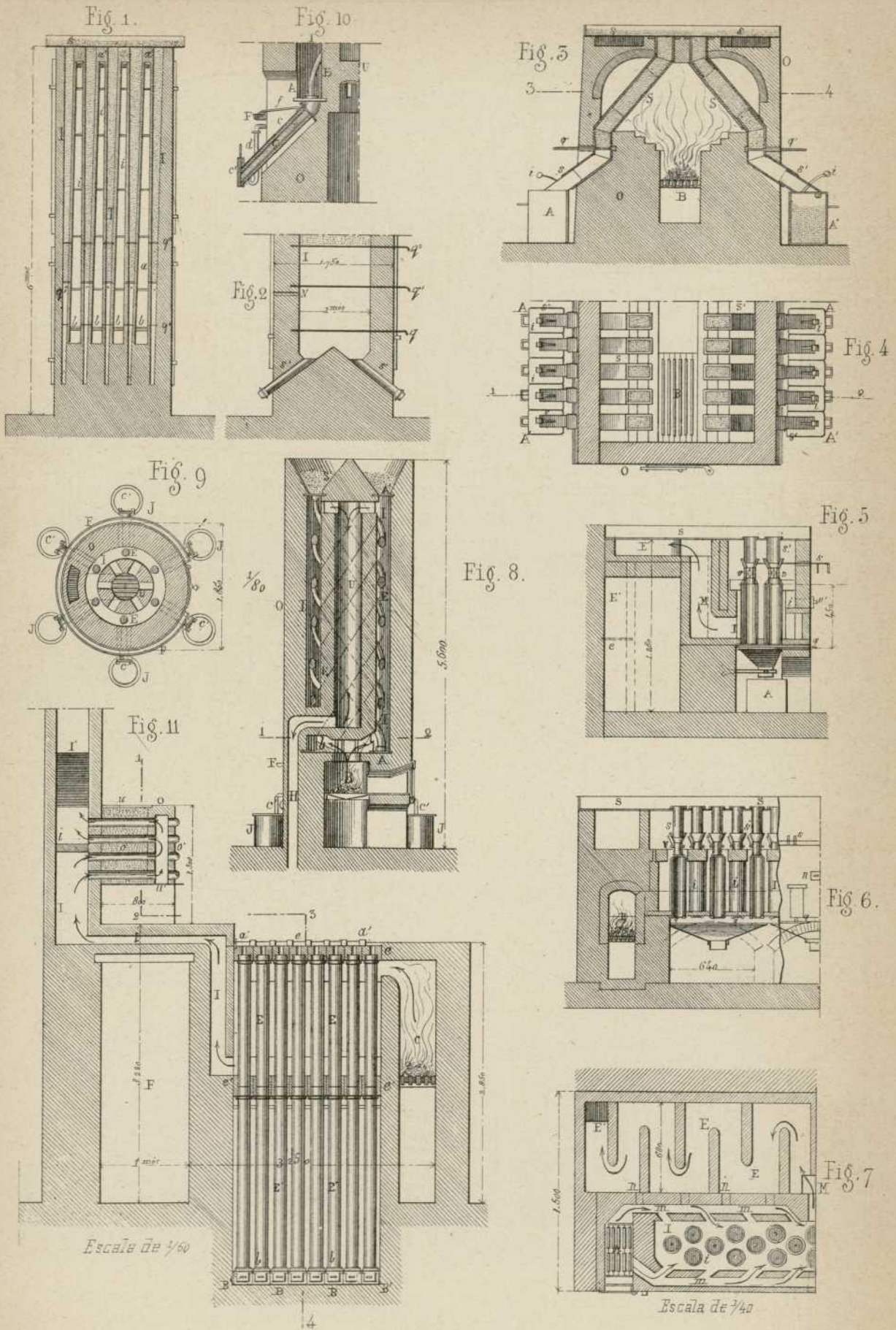


Fig. 13

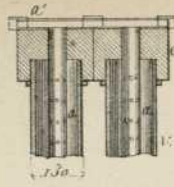


Fig. 14

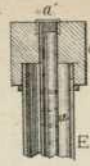


Fig. 16.

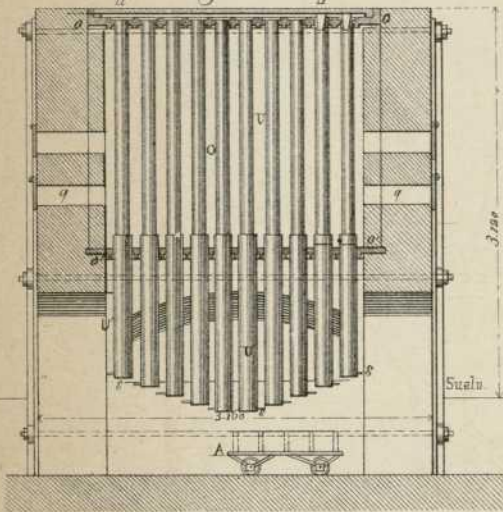


Fig. 15

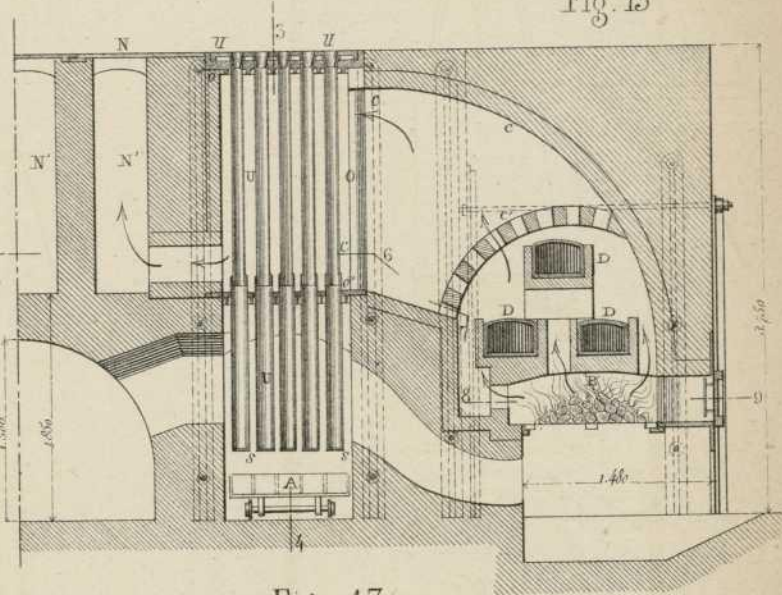


Fig. 12.

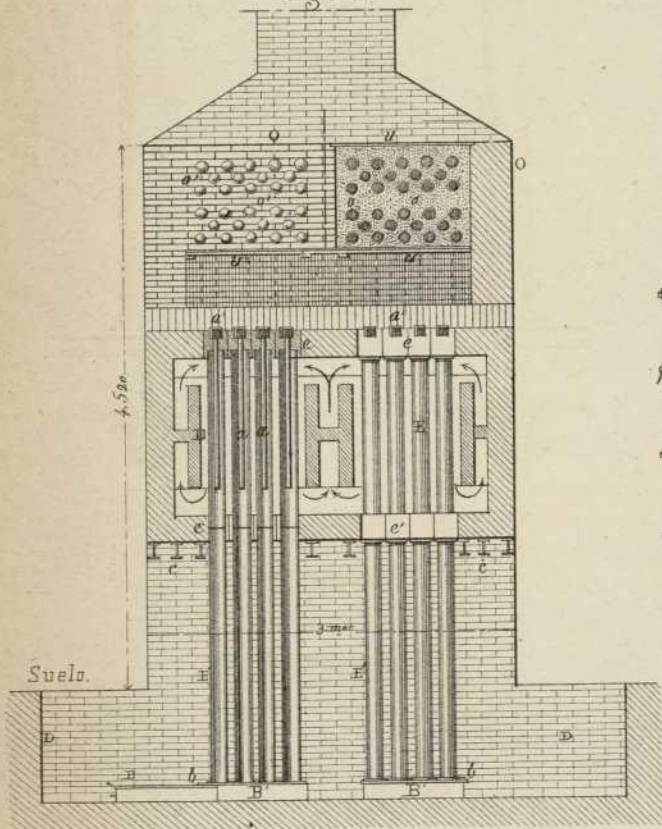


Fig. 17.

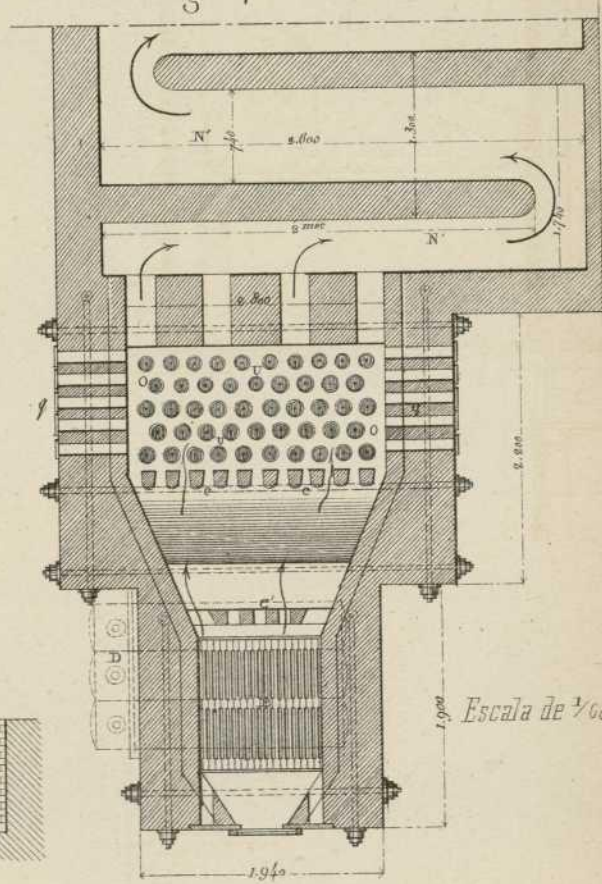


Fig. 4.

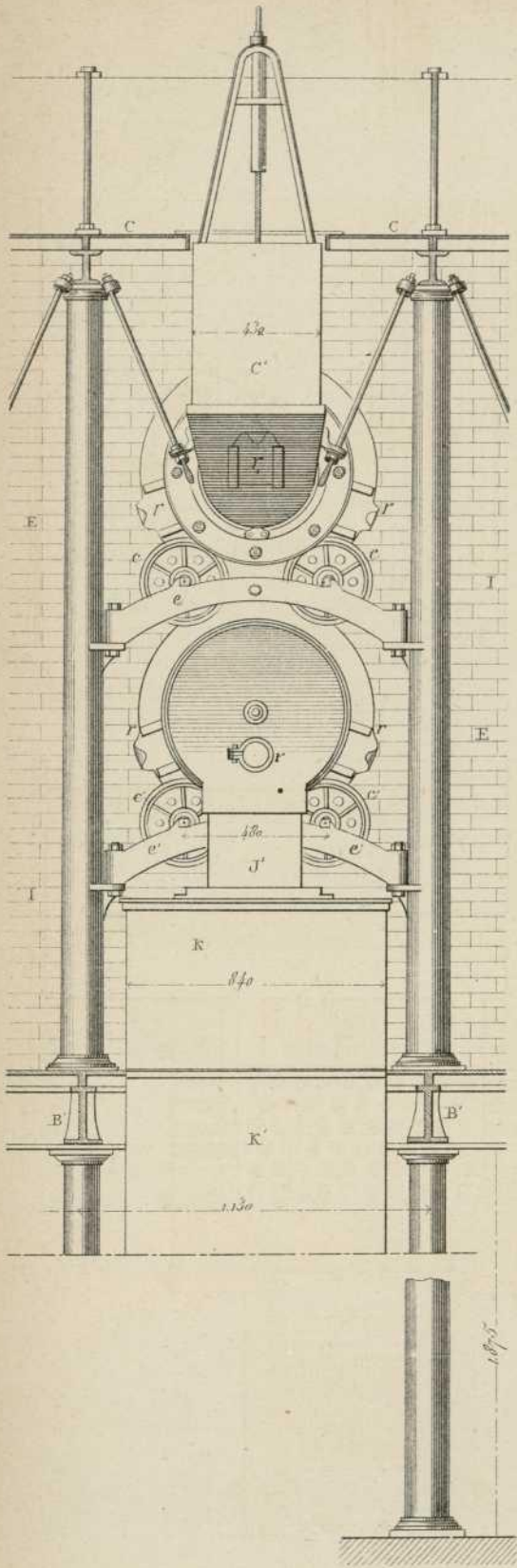


Fig. 2.

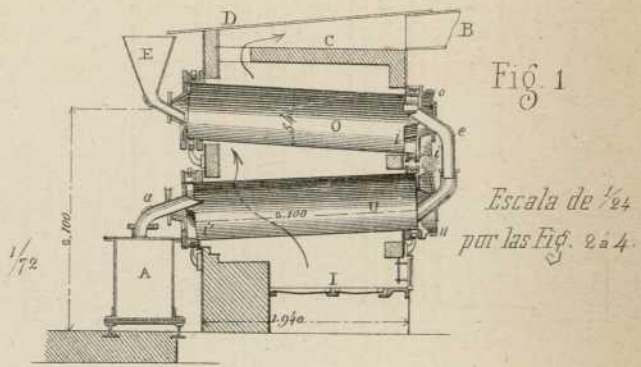
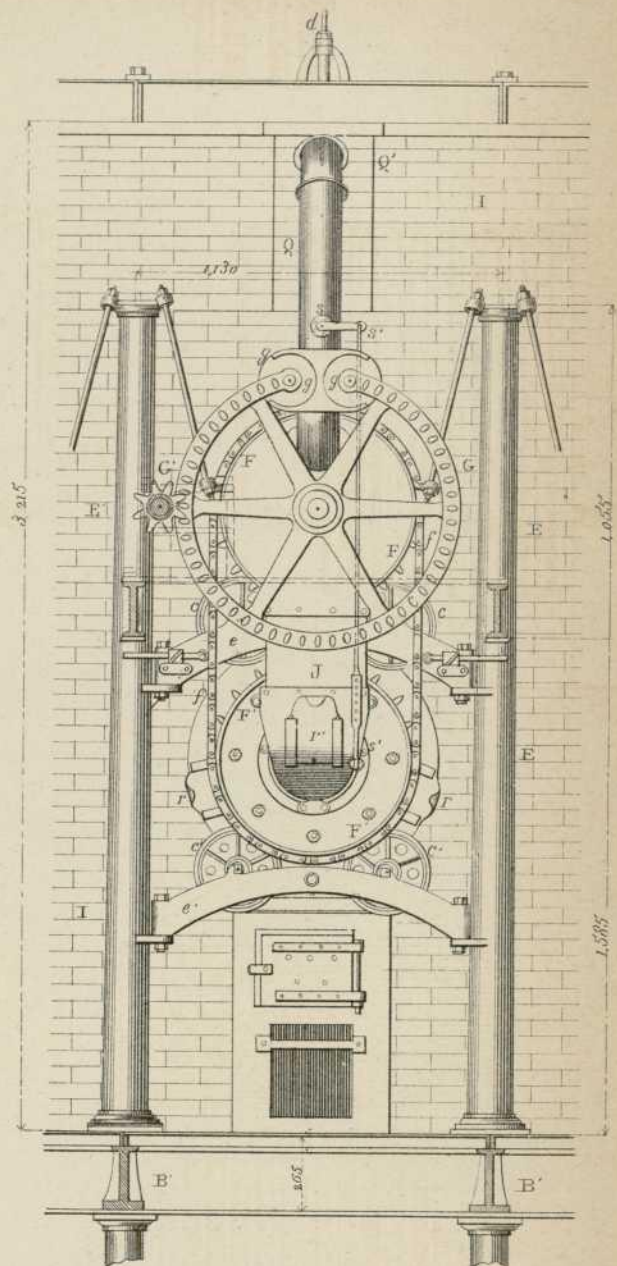


Fig. 5

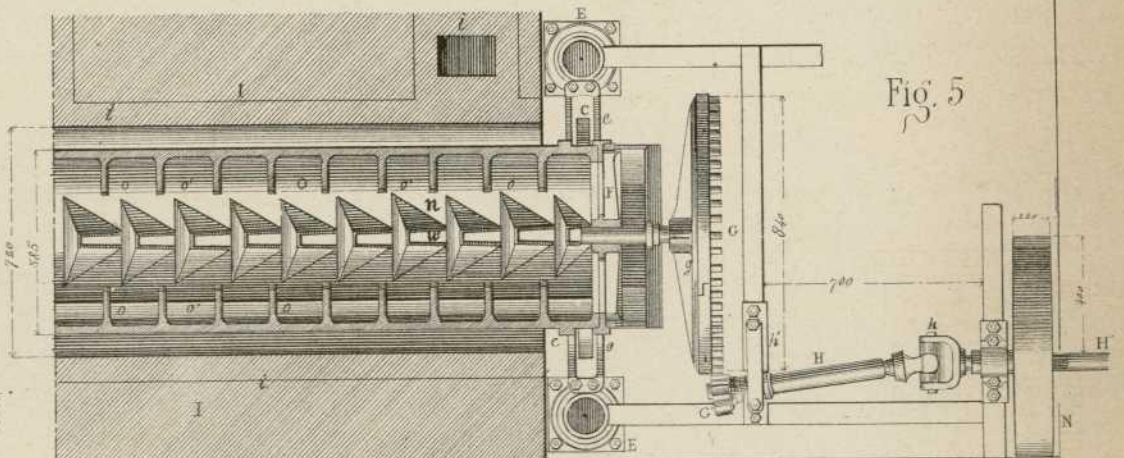
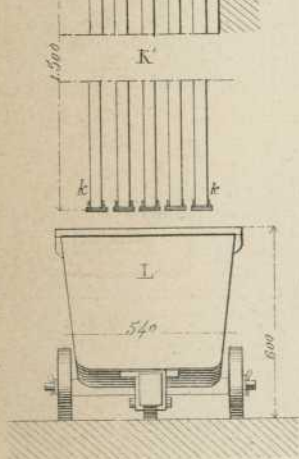
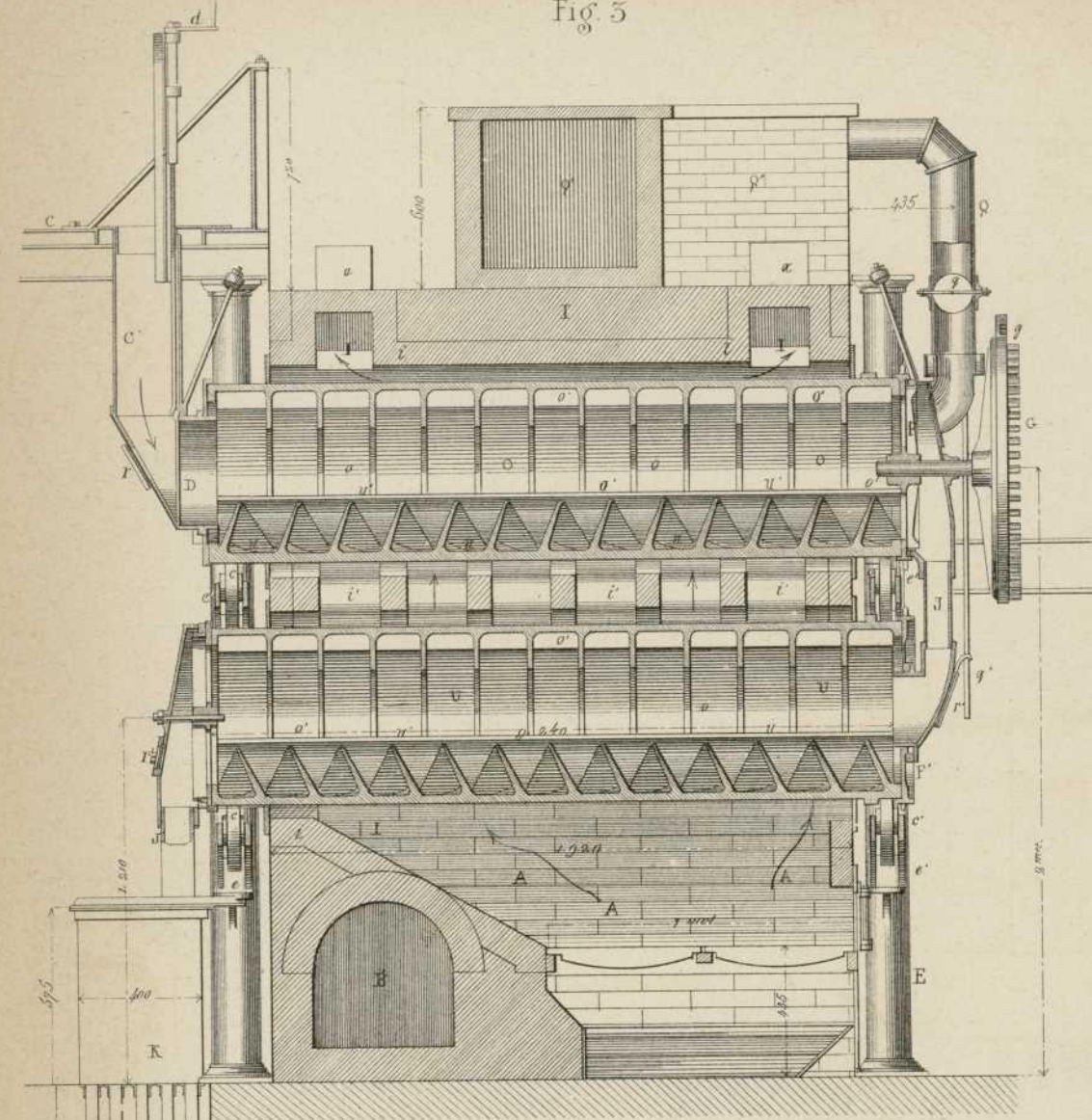


Fig. 5

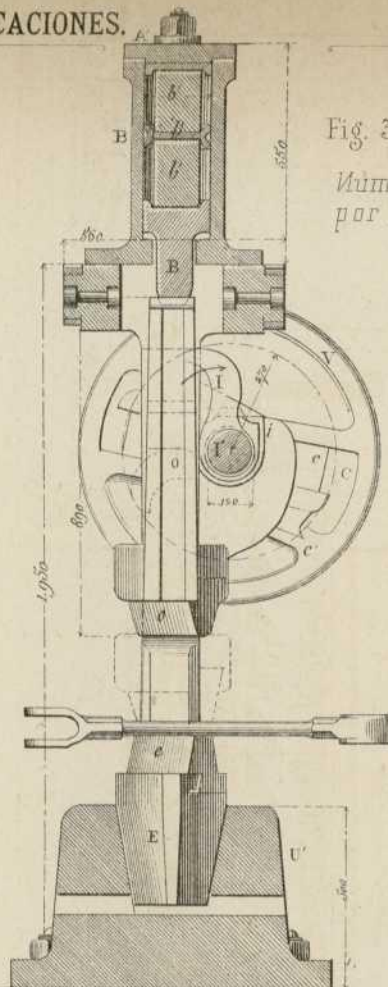


Fig. 3.
Número de golpes
por minuto: 150.

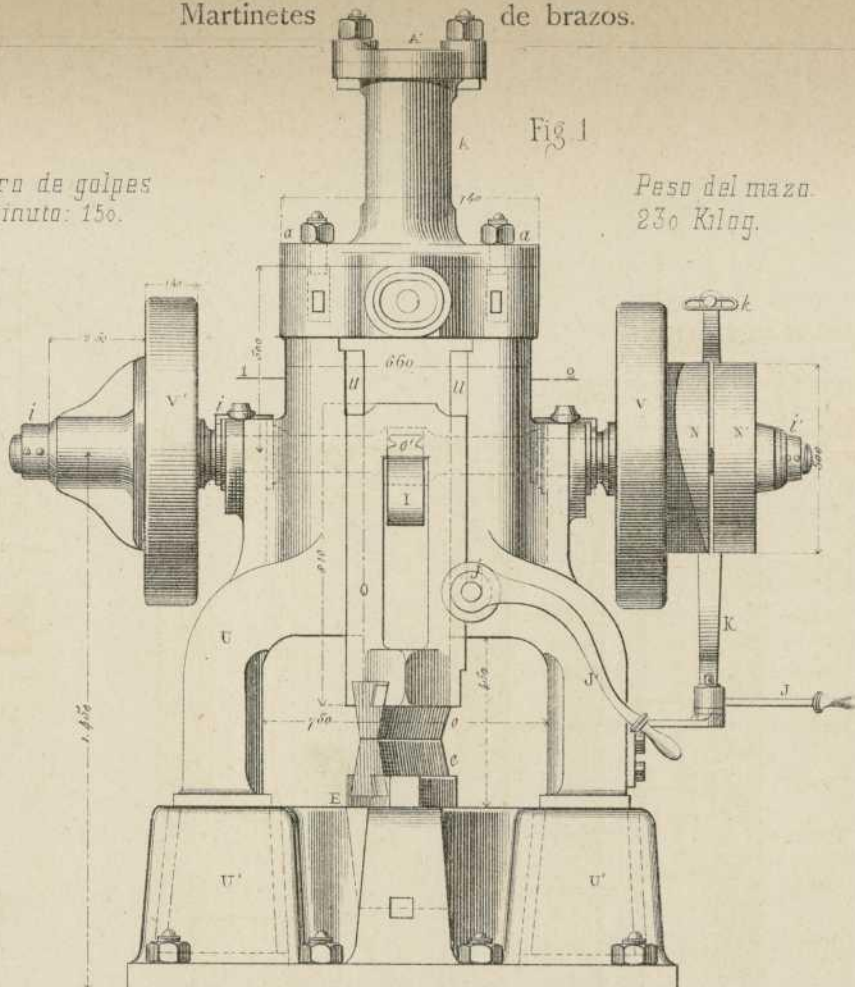


Fig. 1
Peso del maza
230 Kilog.

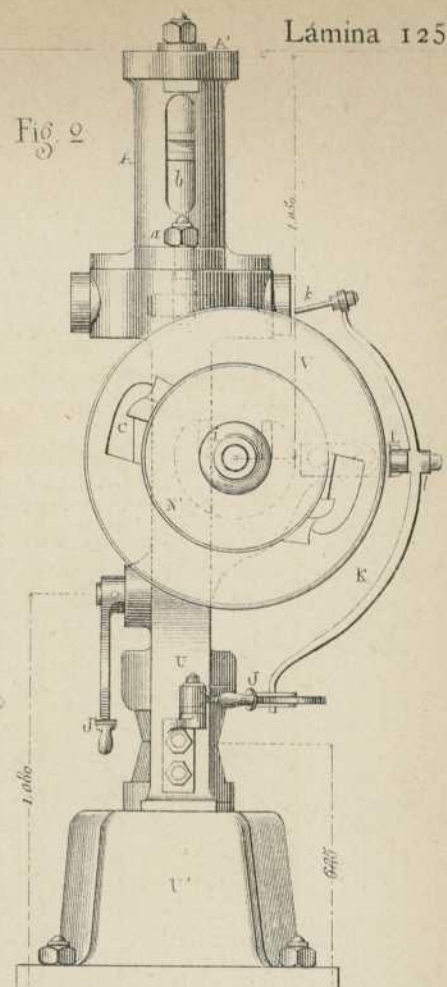


Fig. 2

Fig. 4.

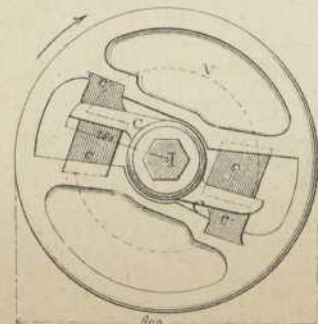
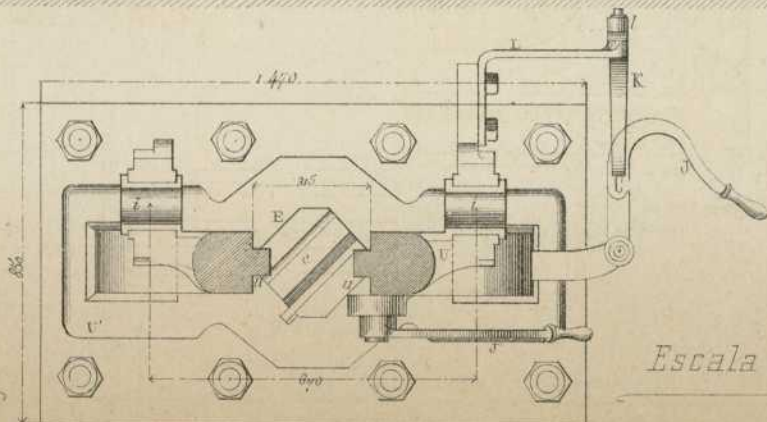


Fig. 5.

Escala de 1/20

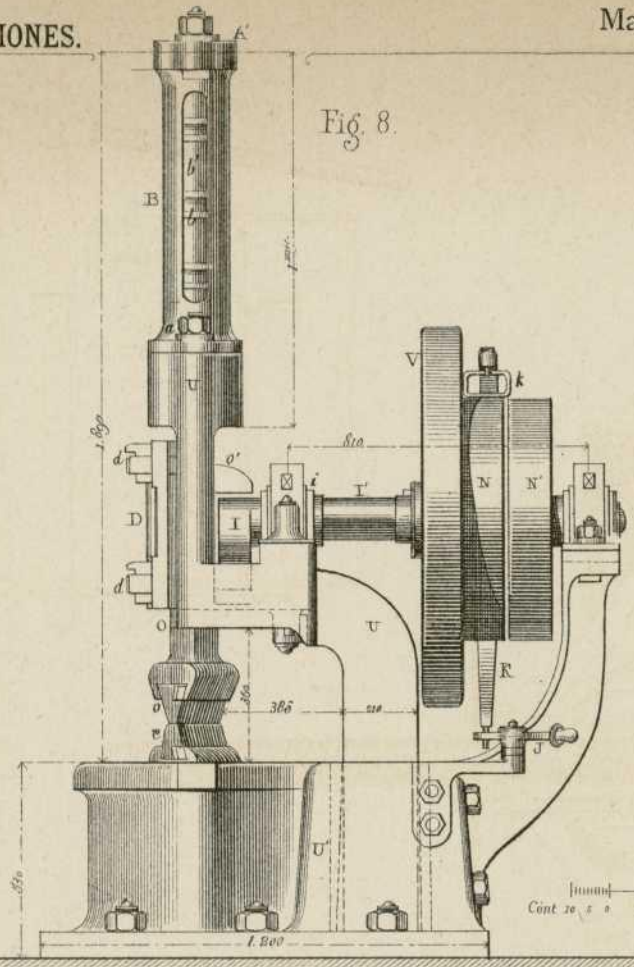


Fig. 8.

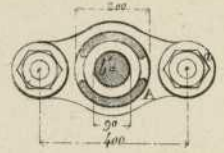


Fig. 11.

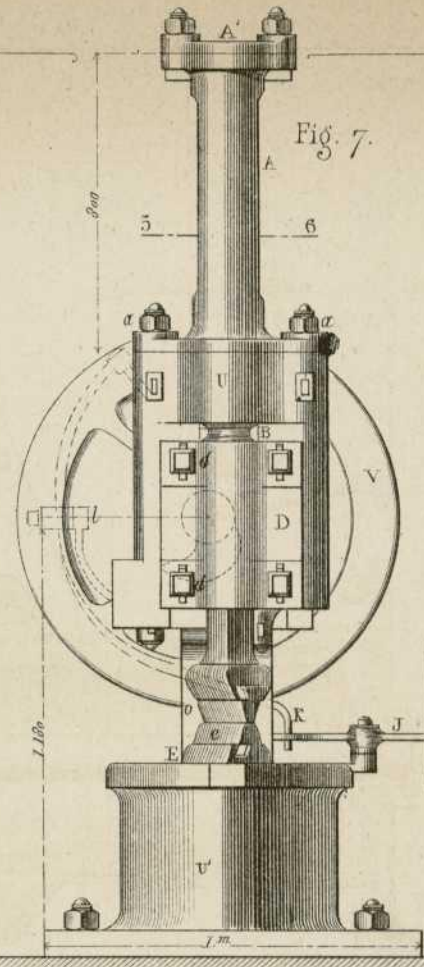


Fig. 7.

Escala de 1/20

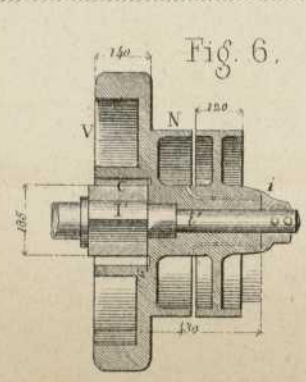
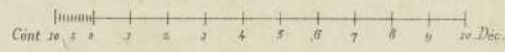


Fig. 6.

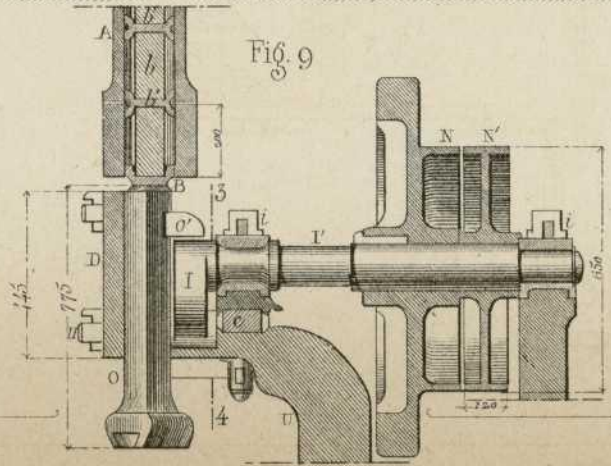


Fig. 9.

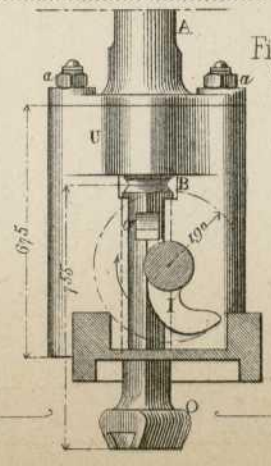


Fig. 10.

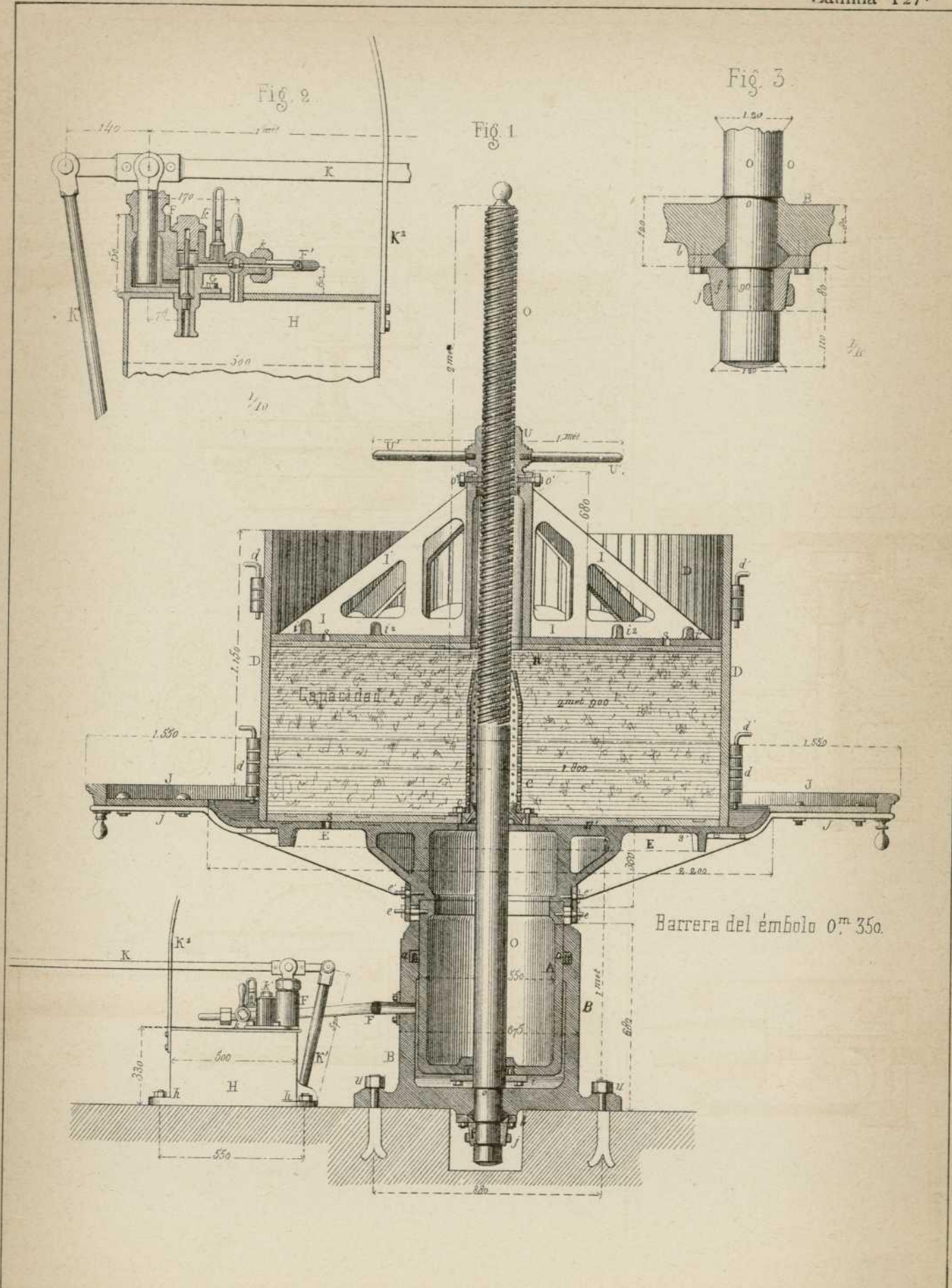


Fig. 4.

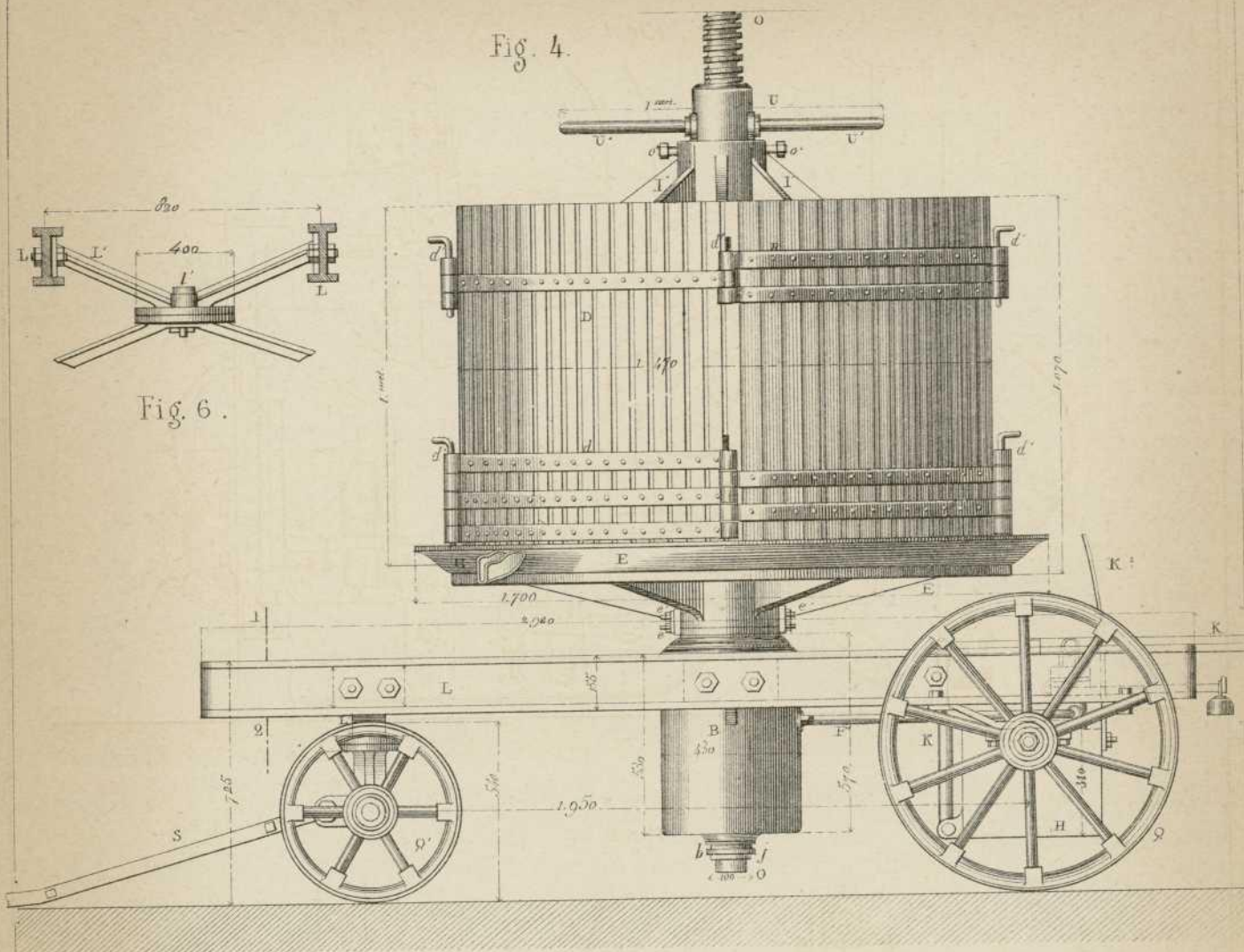
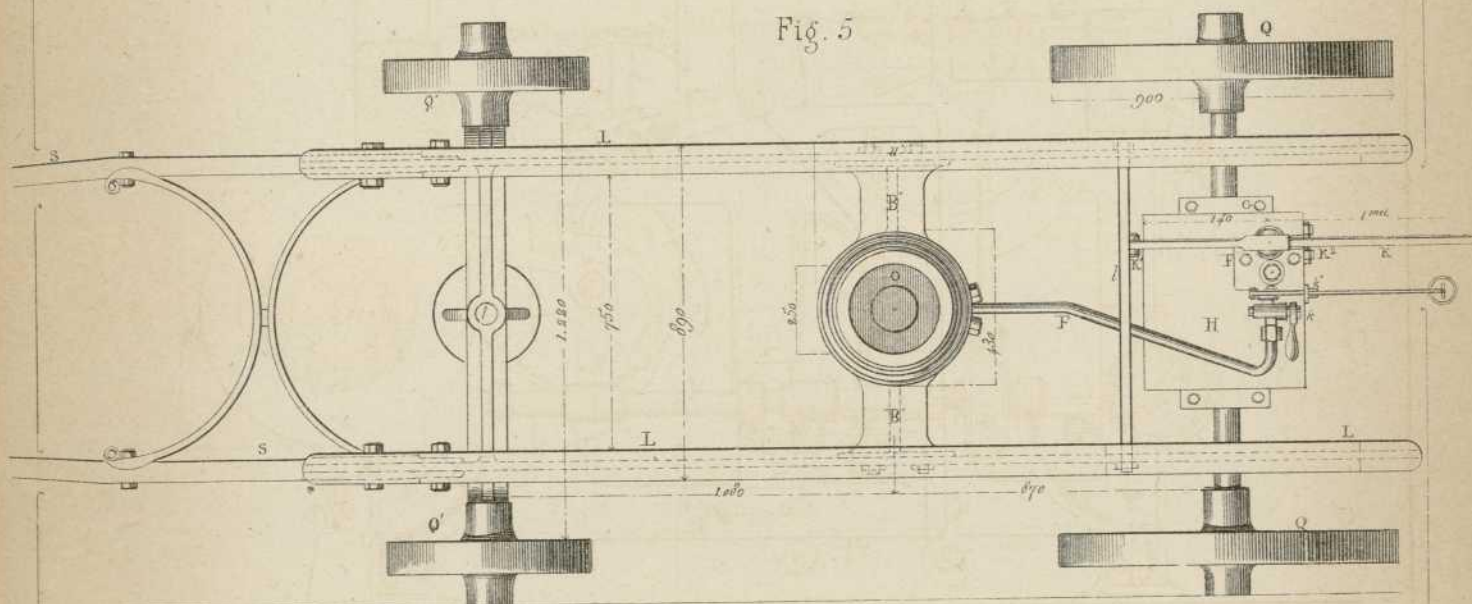


Fig. 6.

Fig. 5



Escala de 1/20 por las Fig. 3, 4 a 6

Fig. 1.

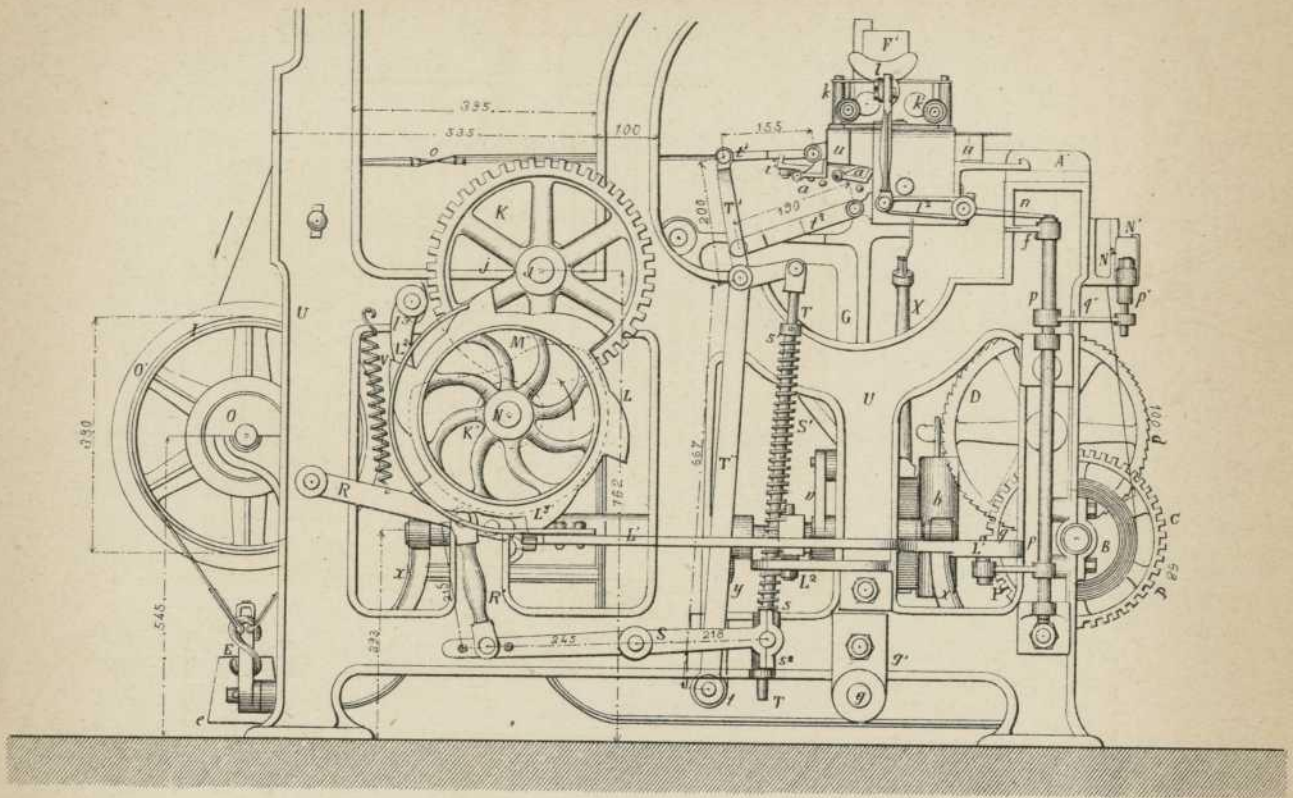
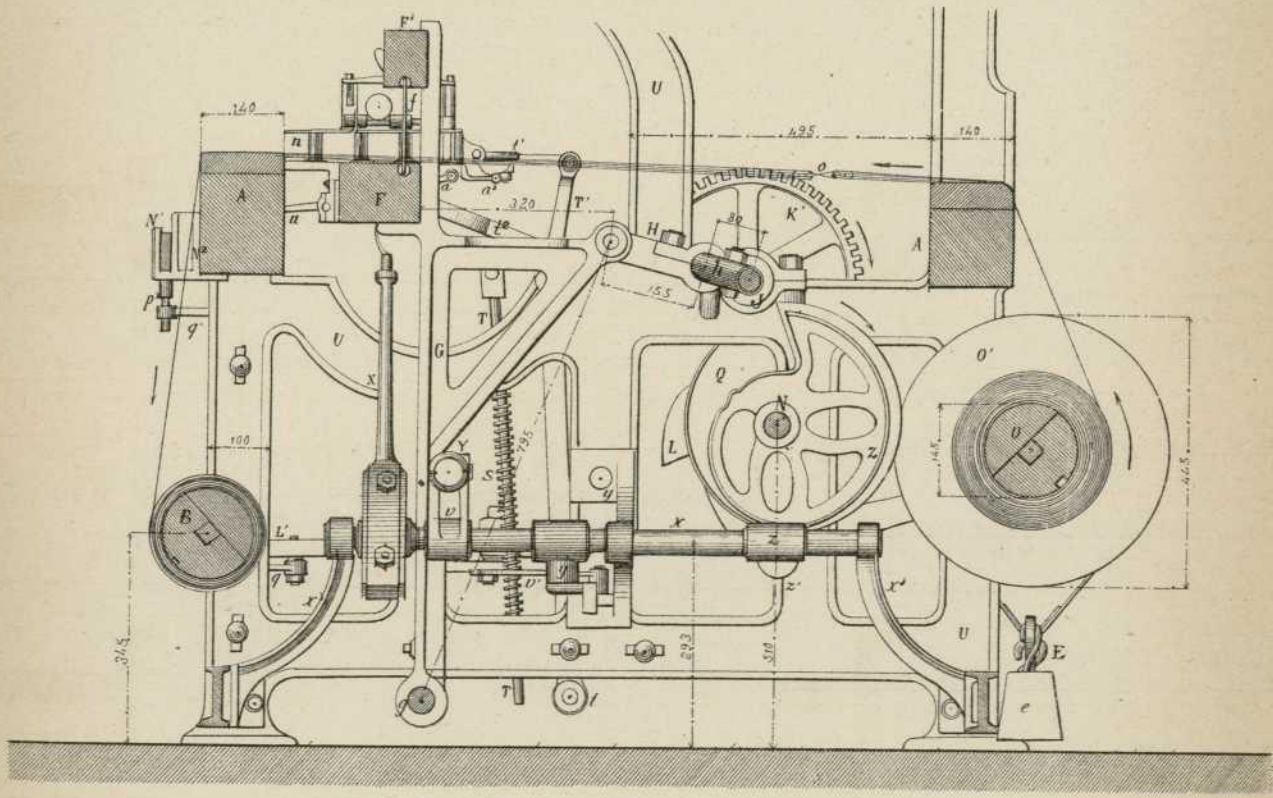


Fig. 2.

Escala de 1/2.



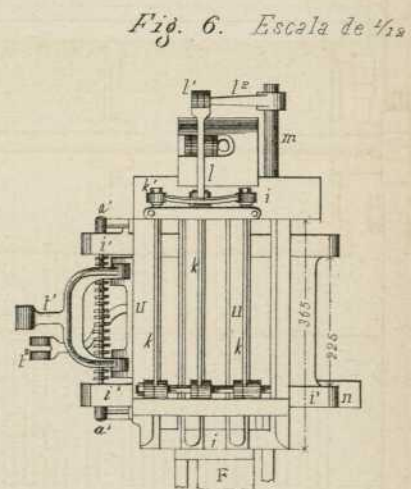
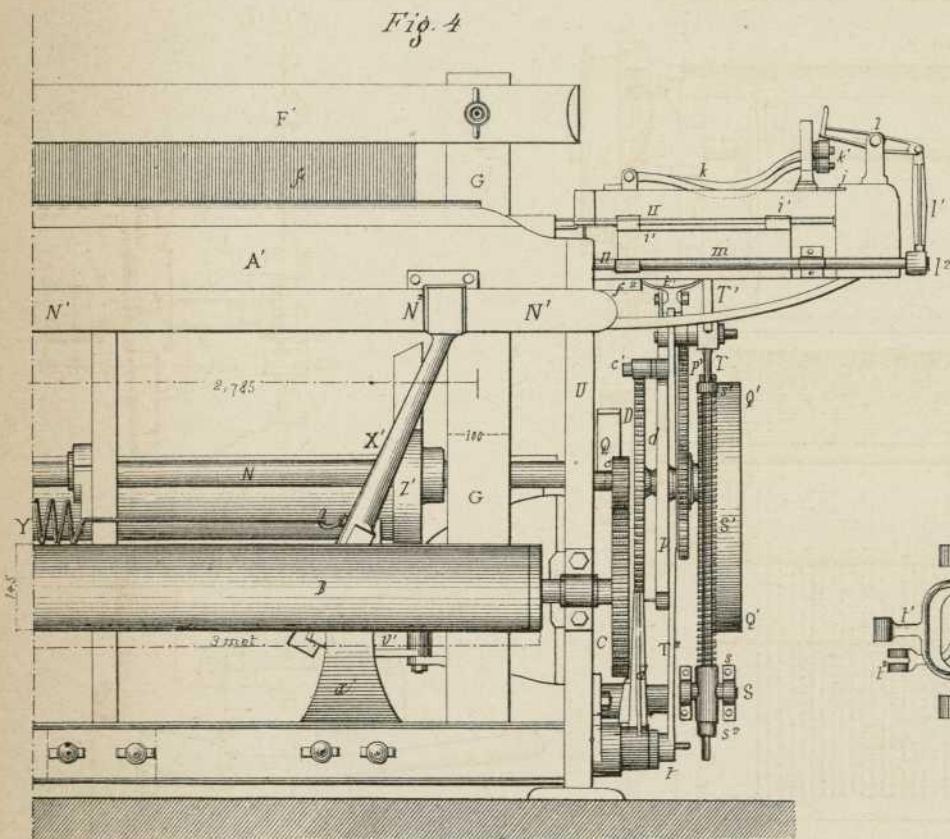
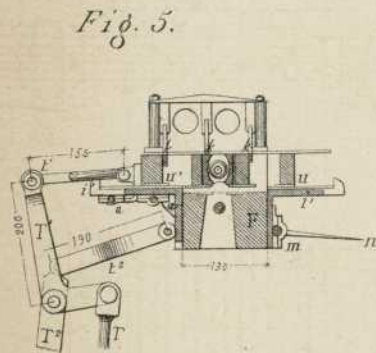
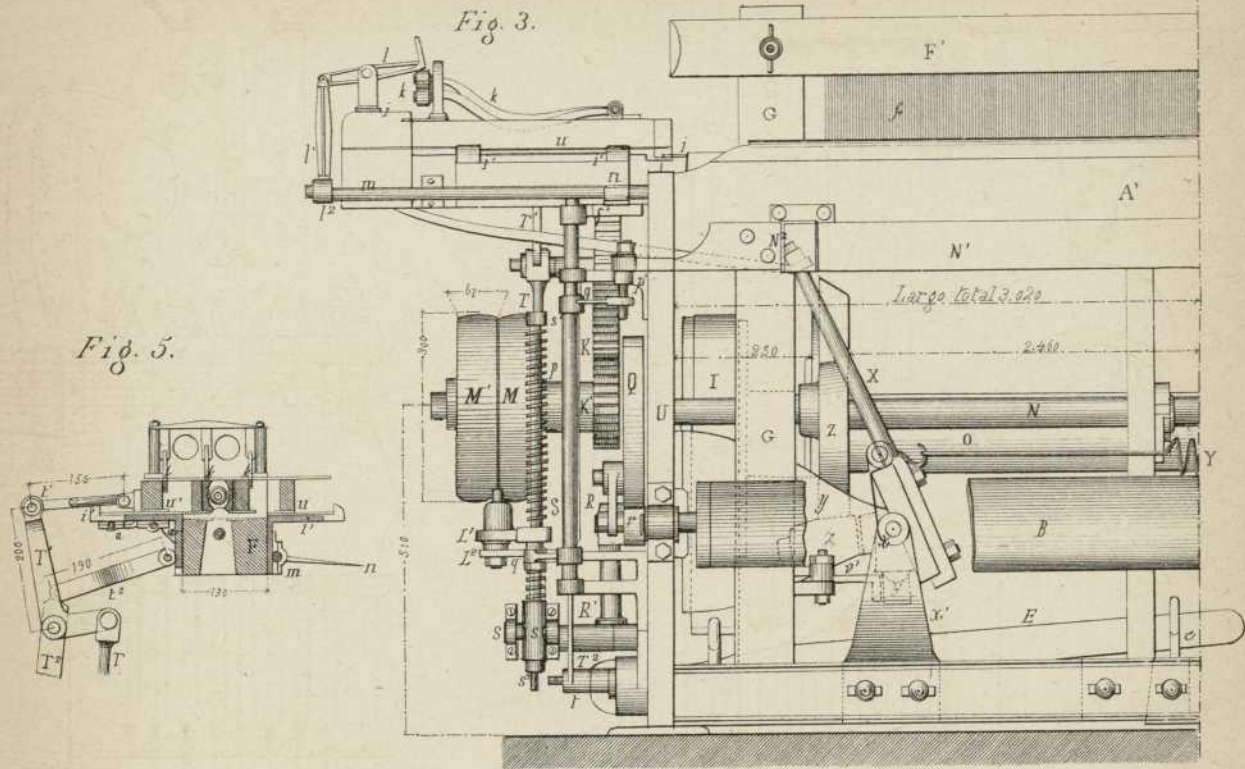
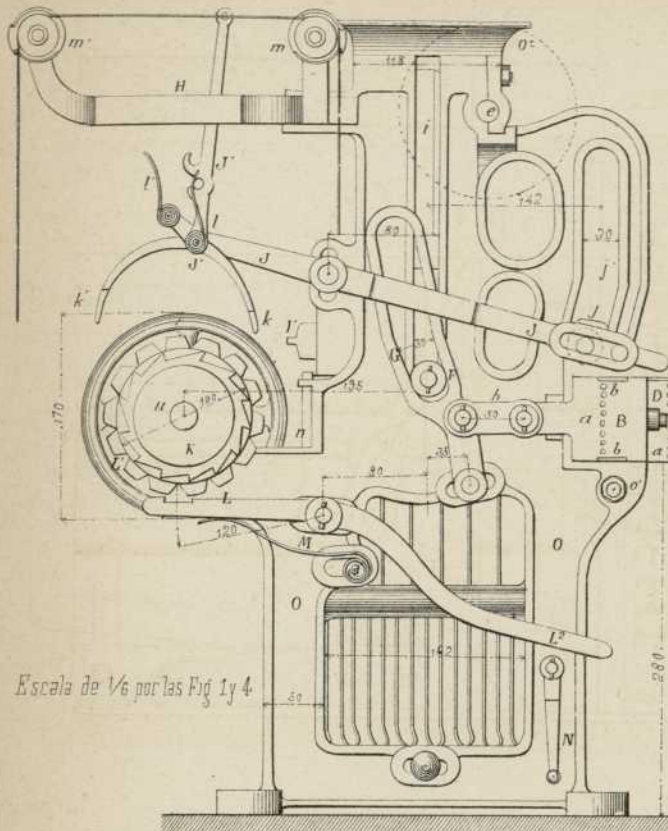


Fig. 1.



Escala de 1/6 por las Fig. 1 y 4.

Fig. 3.

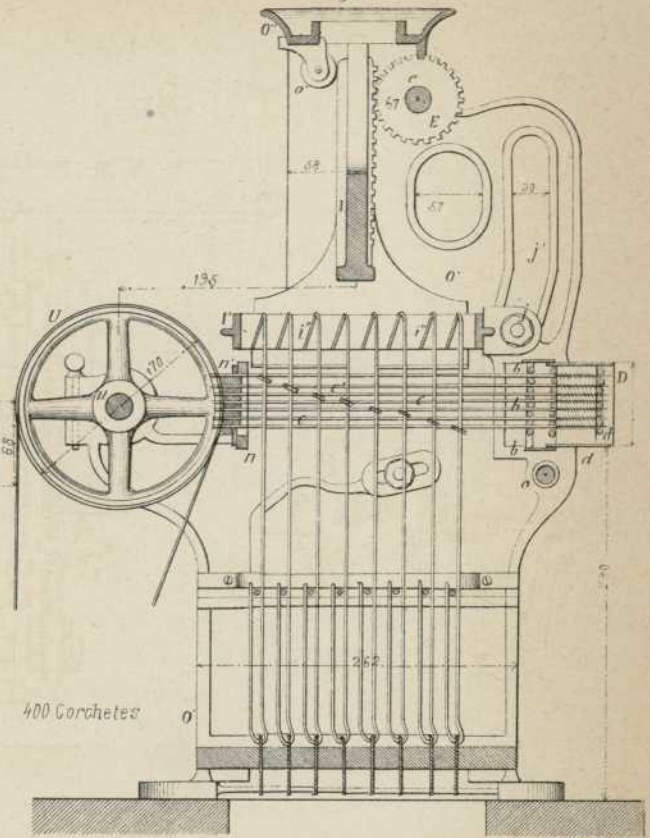


Fig. 2.

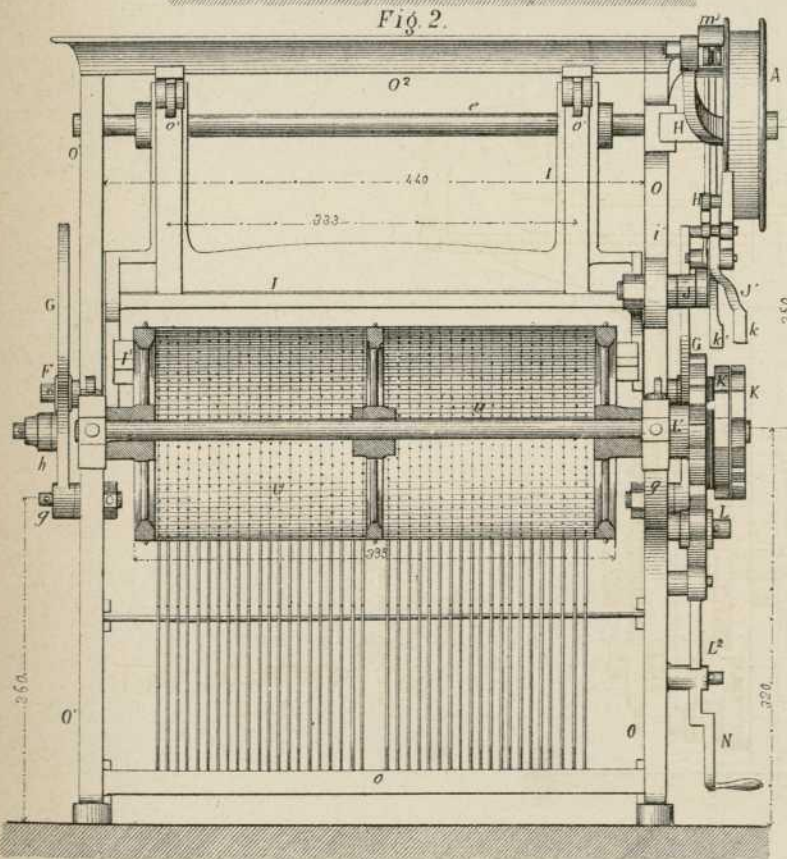


Fig. 7.

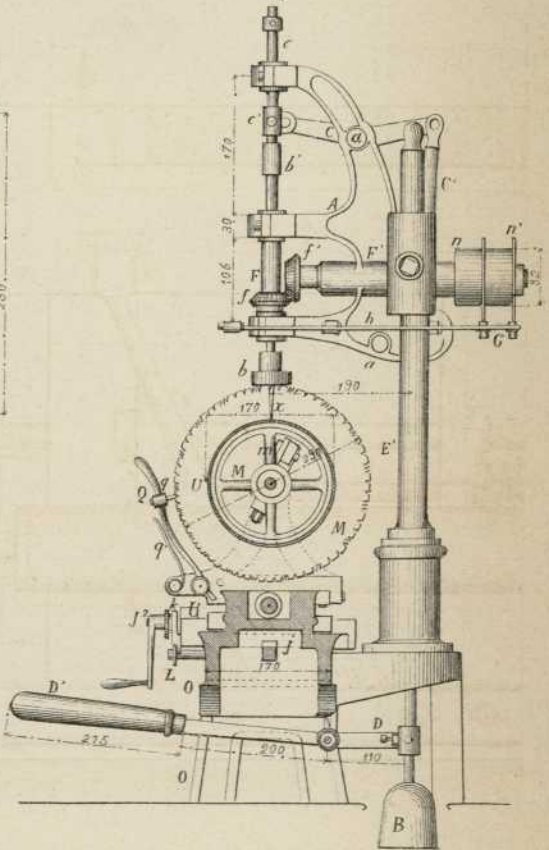


Fig. 4.

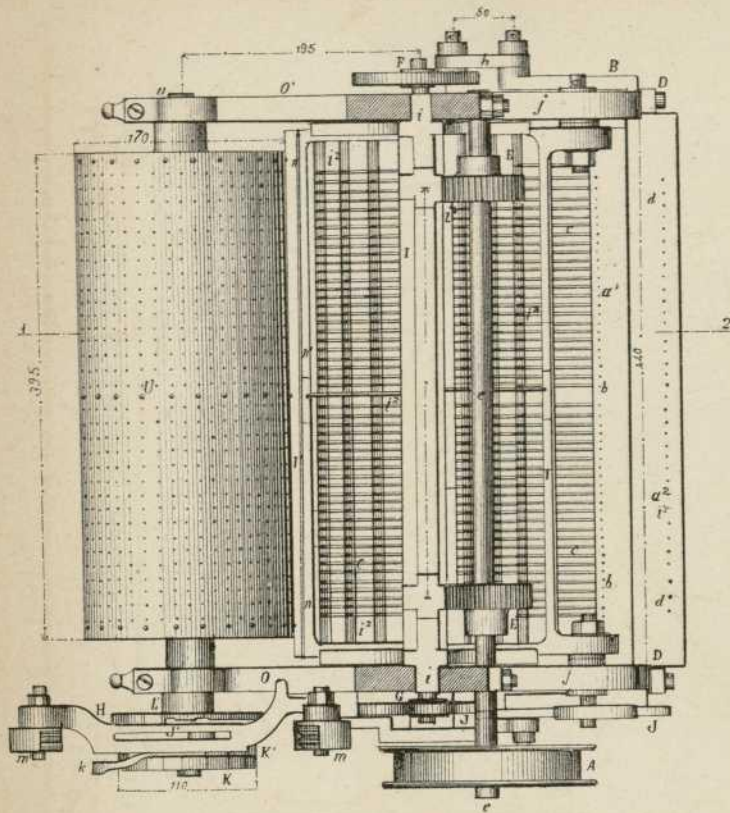


Fig. 5.

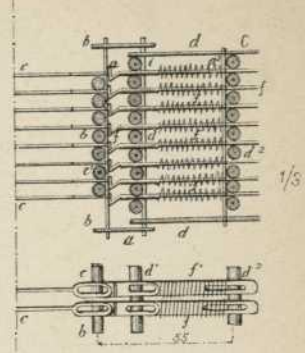


Fig. 8.

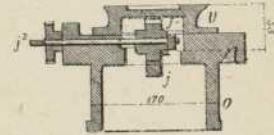


Fig. 9.

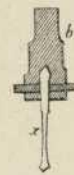
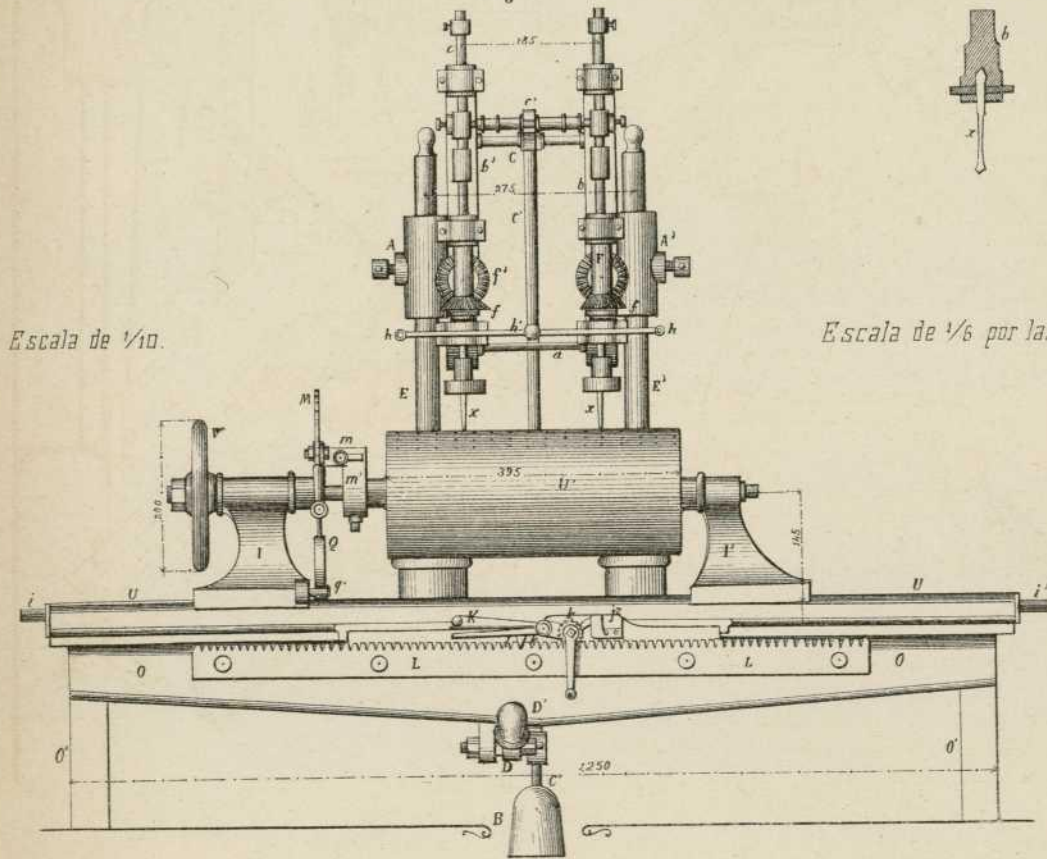


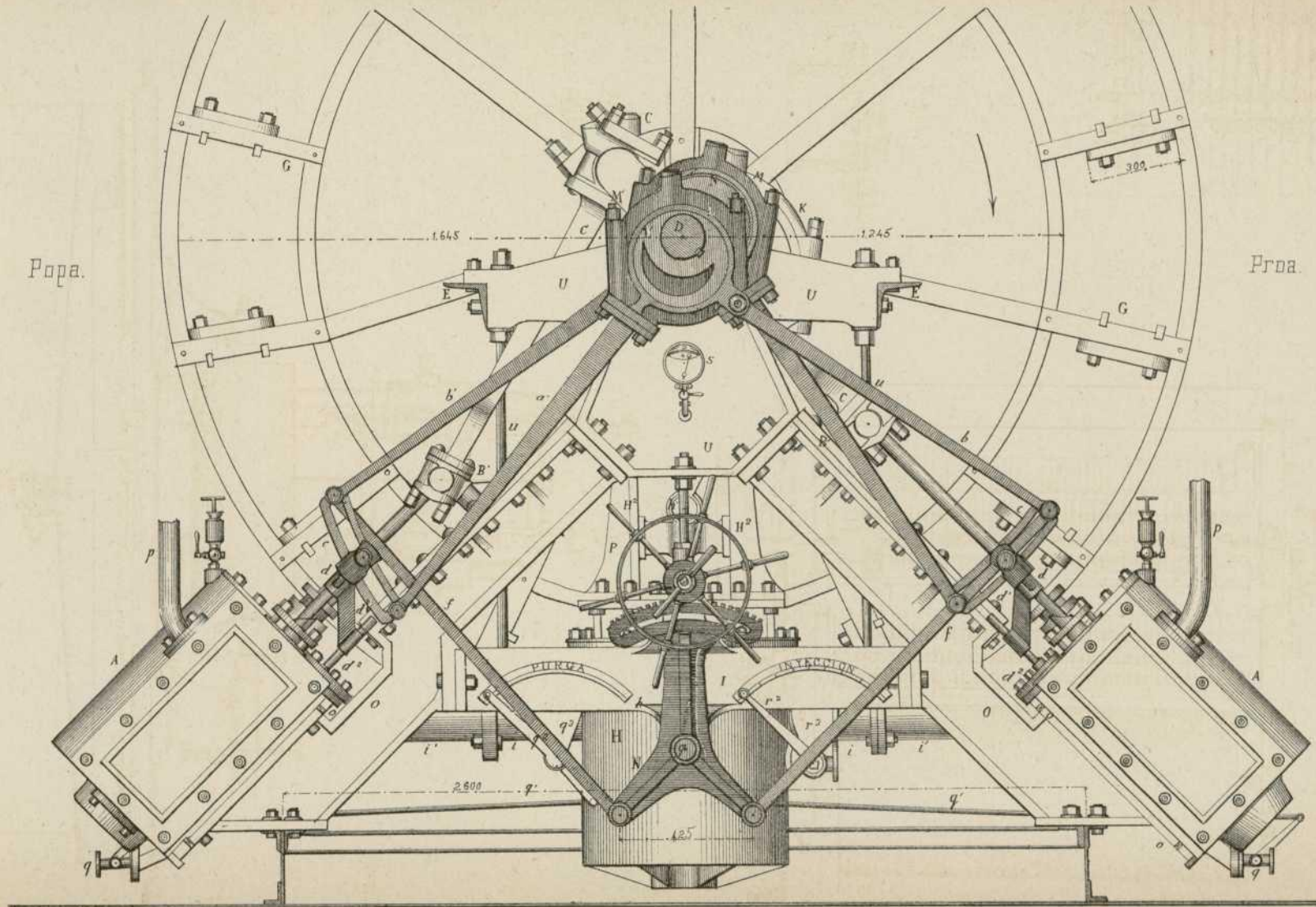
Fig. 6.



Escala de 1/10.

Escala de 1/6 por las Fig. 1 à 4.

Fig 1.



Escala de 1/20.

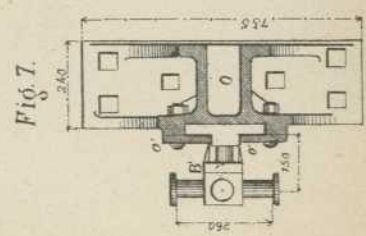
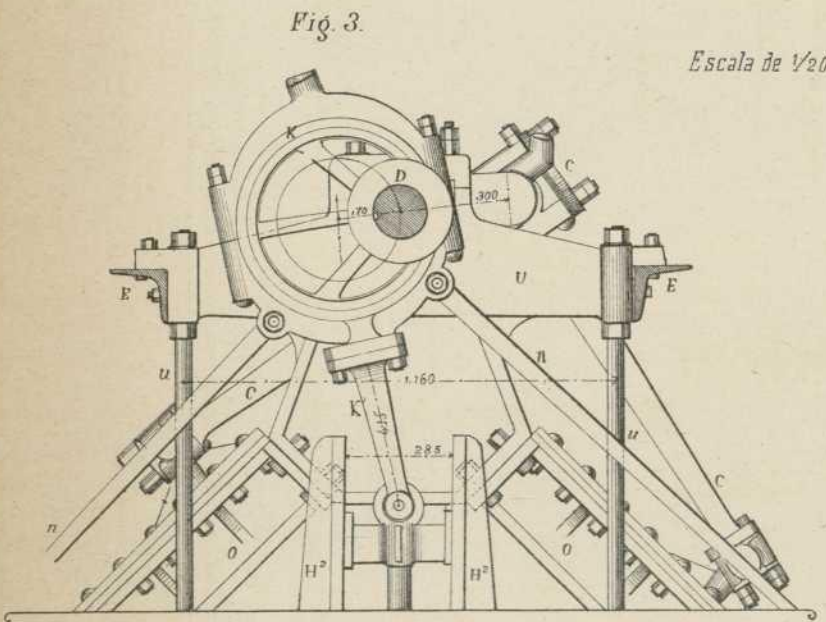
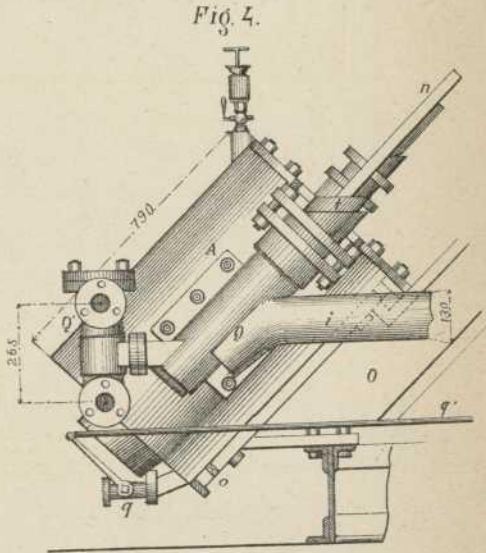
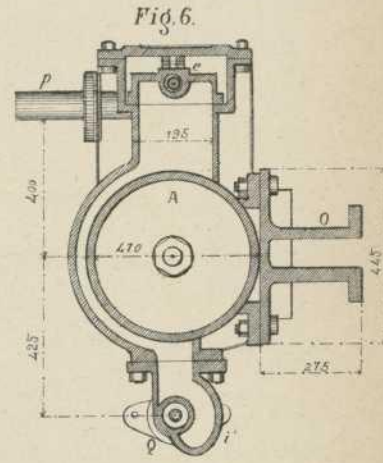
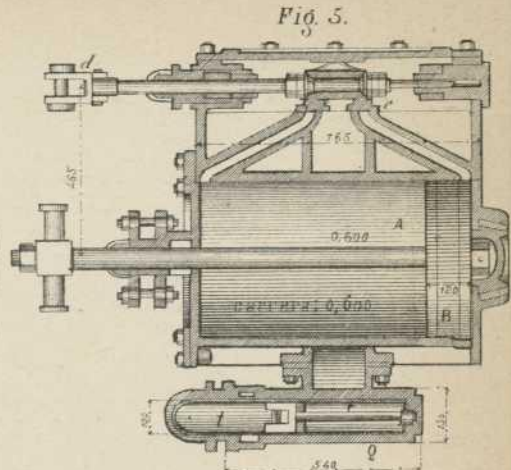
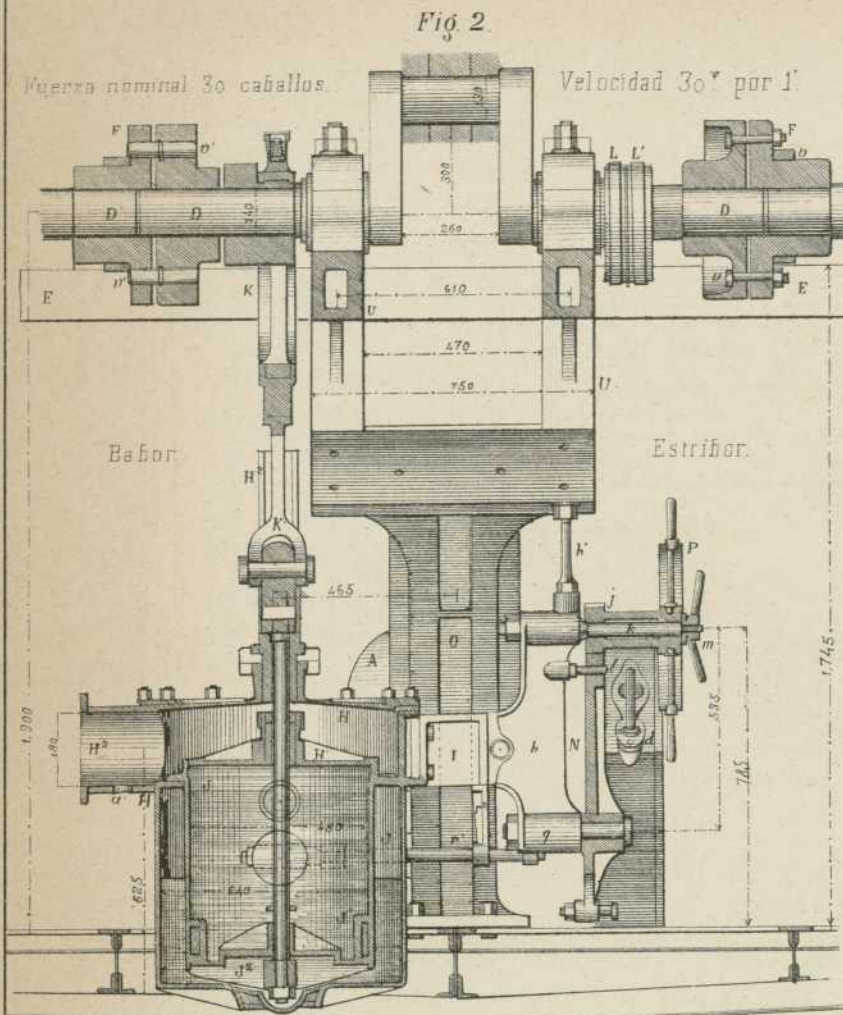


Fig. 10.

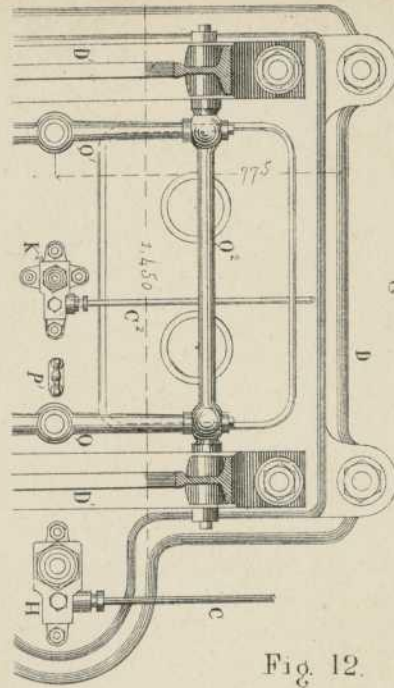
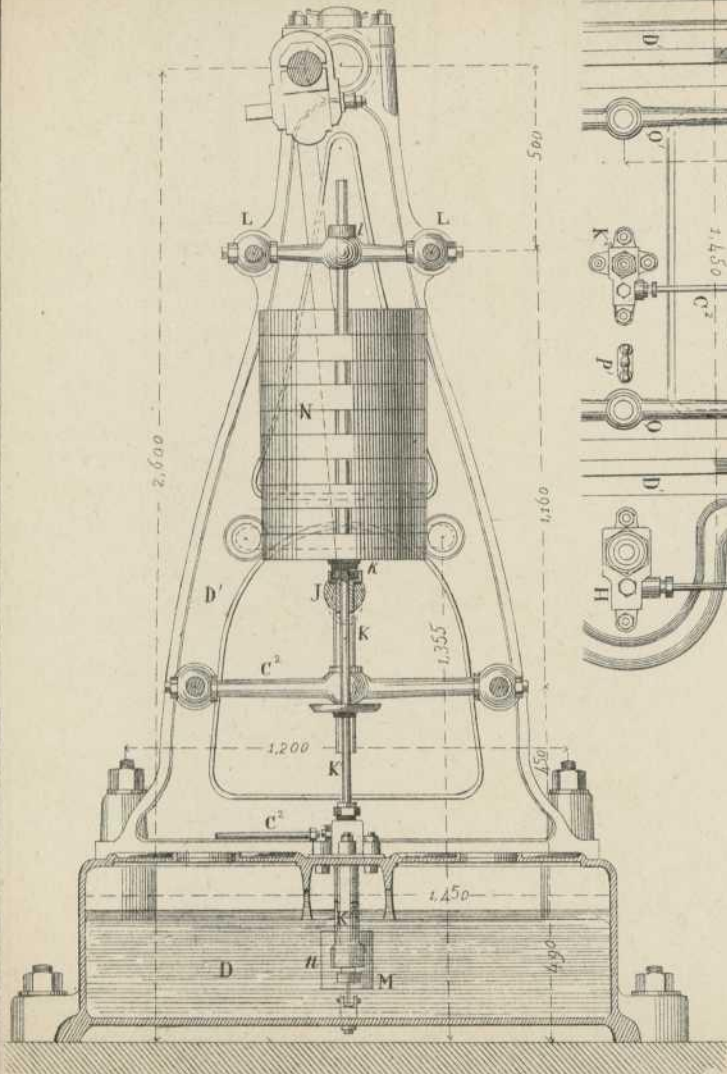


Fig. 11.

Fig. 12.

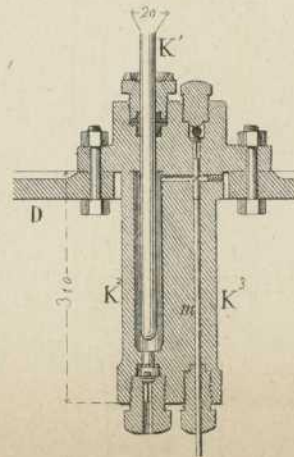
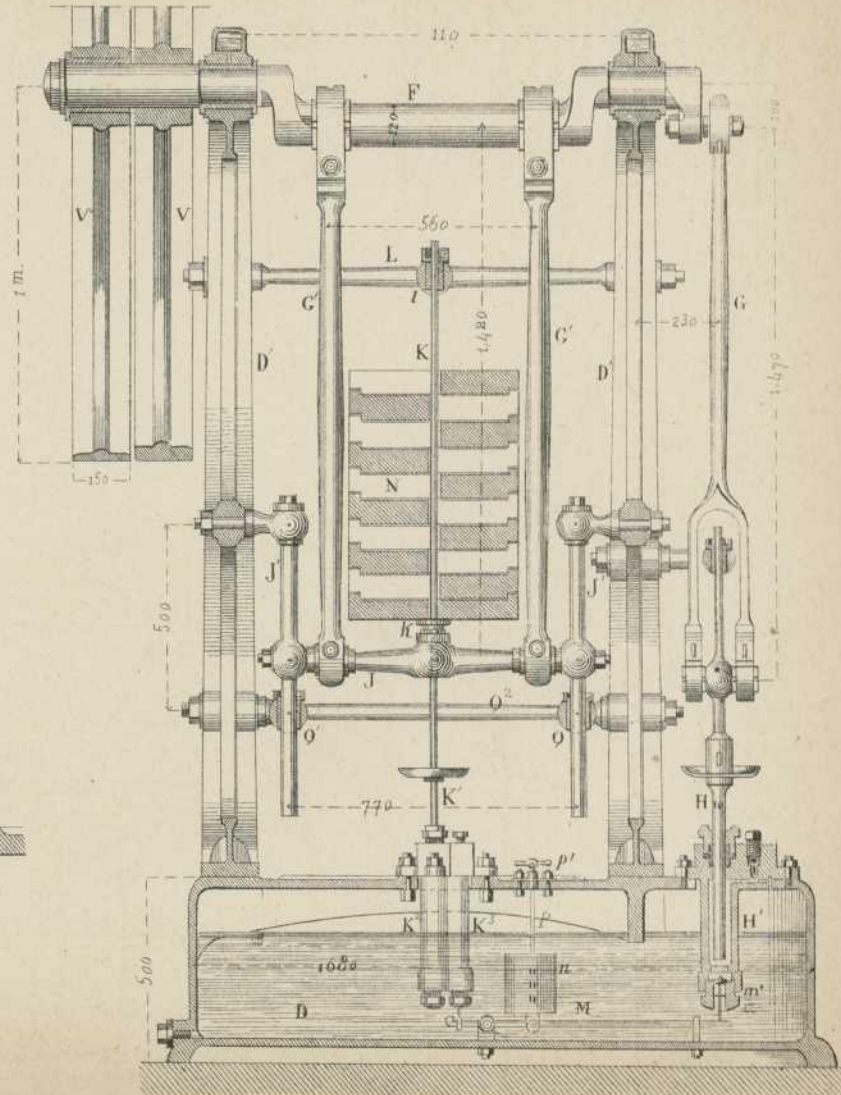


Fig. 9.



Escala de 1/20.

J. G.

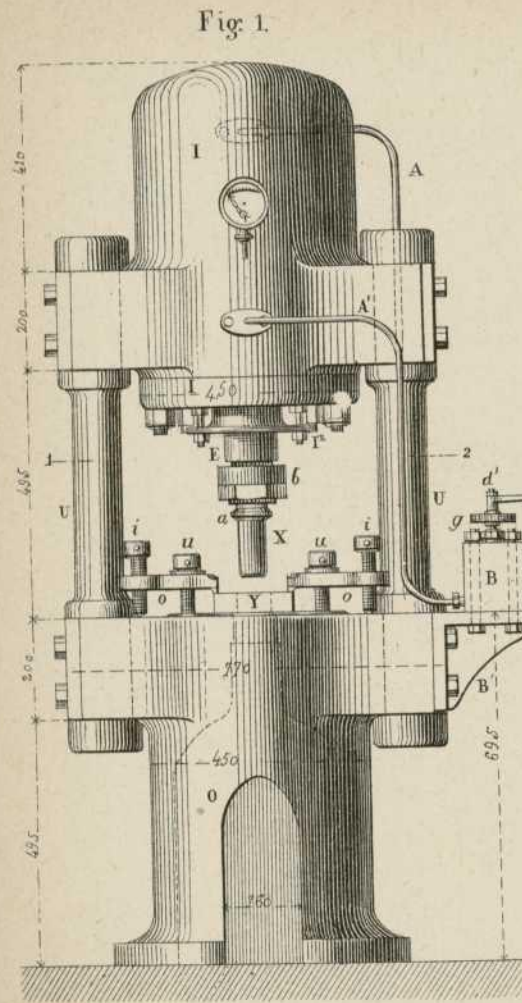


Fig. 1.

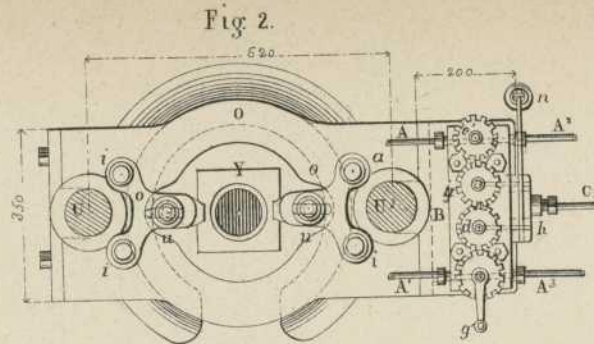


Fig. 2.

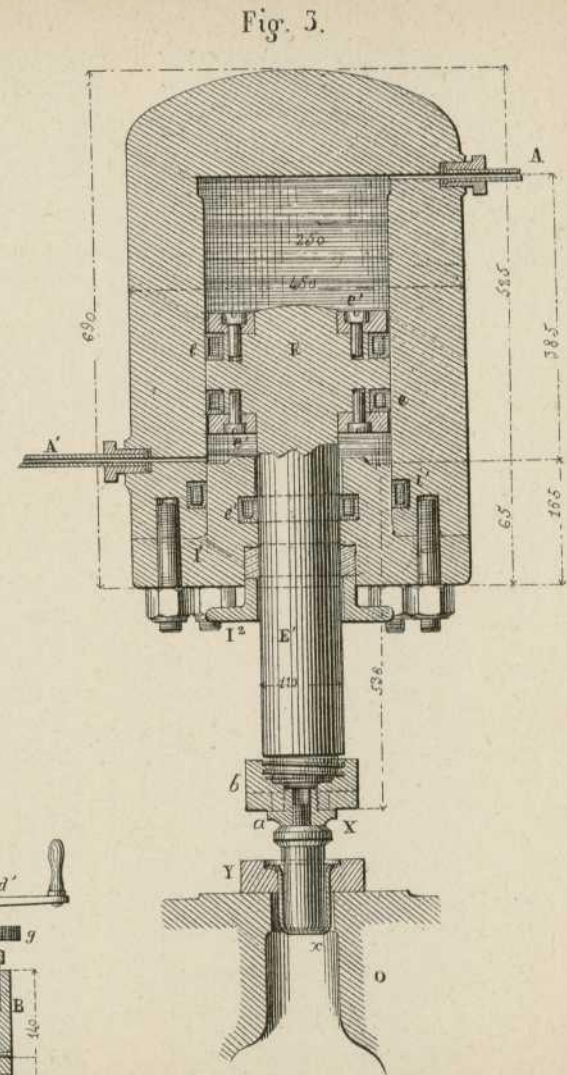


Fig. 3.

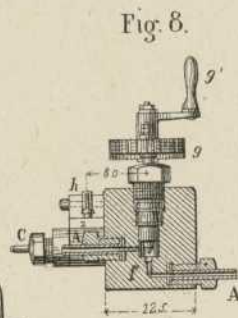


Fig. 8.

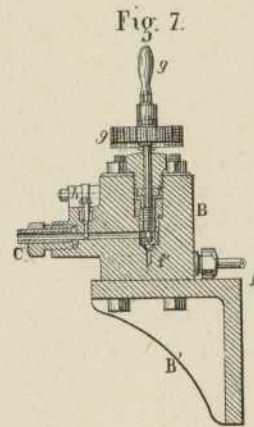


Fig. 7.

Escala de 1/10

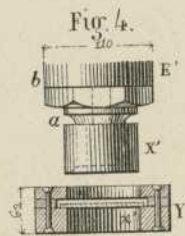


Fig. 4.

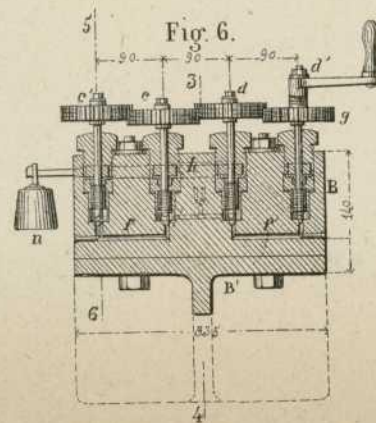


Fig. 6.

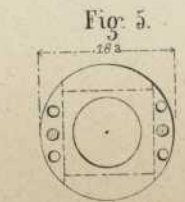


Fig. 5.

Escala de 1/5 por las Fig 1 y 2.

EM

Diámetro de los cilindros 0^m230
 Curso de los émbolos 0^m250
 Diámetro de las ruedas 0^m750

Fig. 1

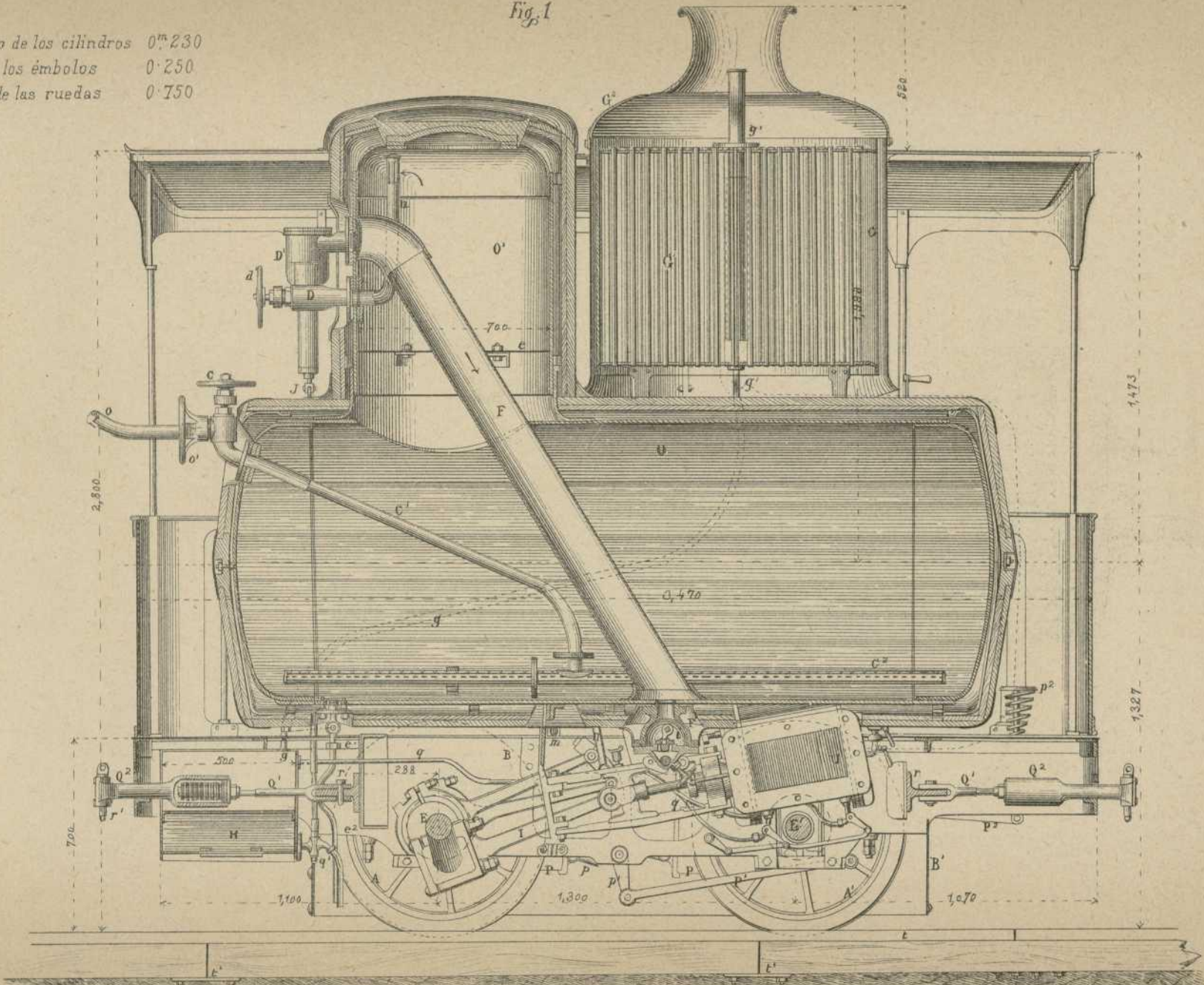
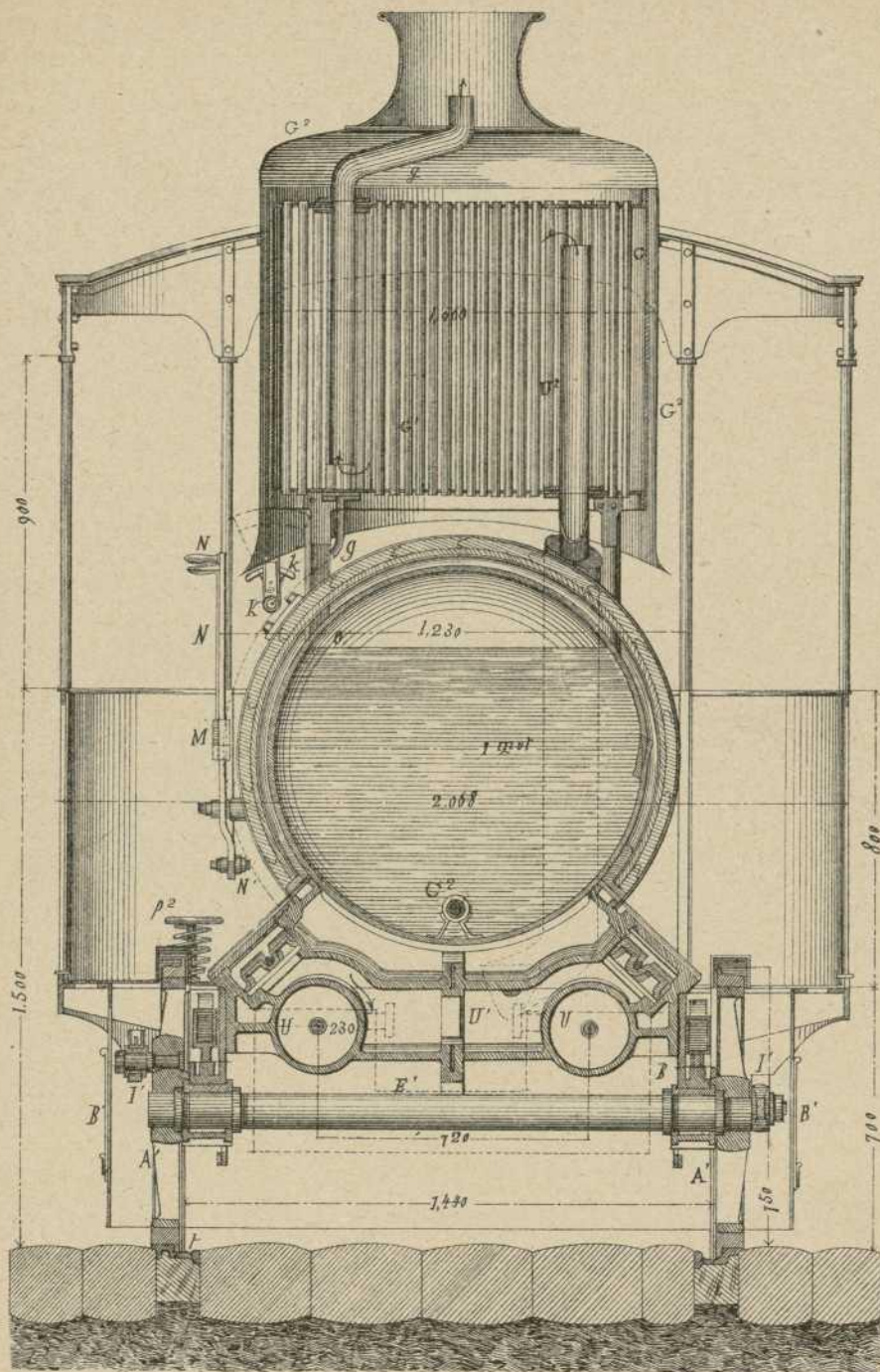


Fig. 2.



Escala de $\frac{1}{50}$

Tímbre del depósito.....	15 kil.
Volumen de agua en lleno.....	1 ^m c. 800.
Peso de la máquina vacía.....	6780 kil.
id id en servicio.....	8745

Fig. 9.

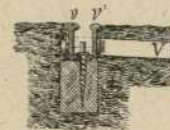


Fig. 3.

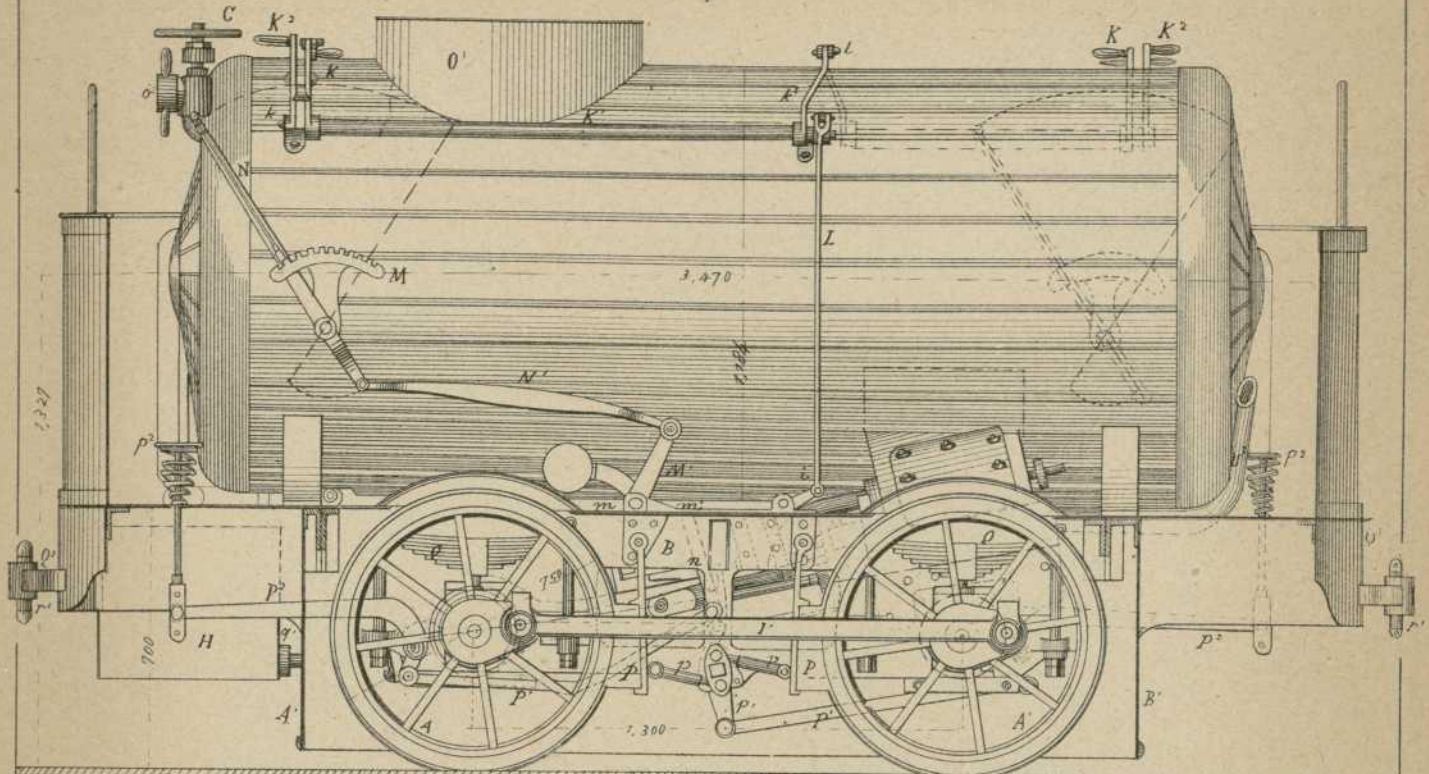
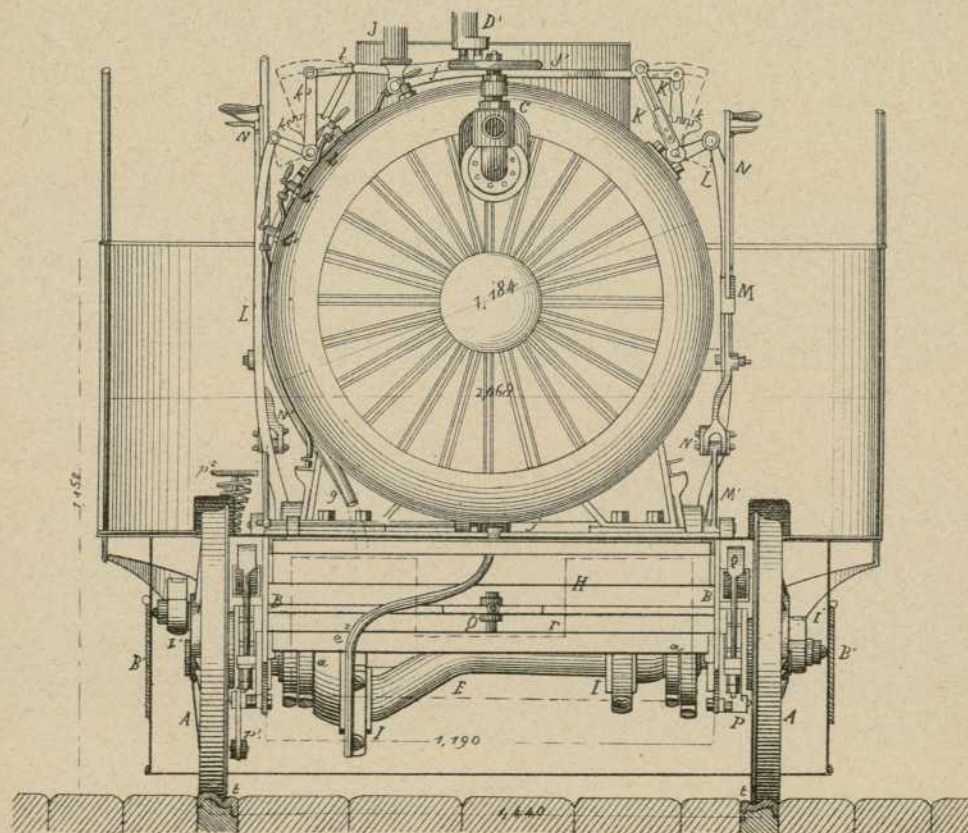


Fig. 4.

Escala de $\frac{1}{20}$.



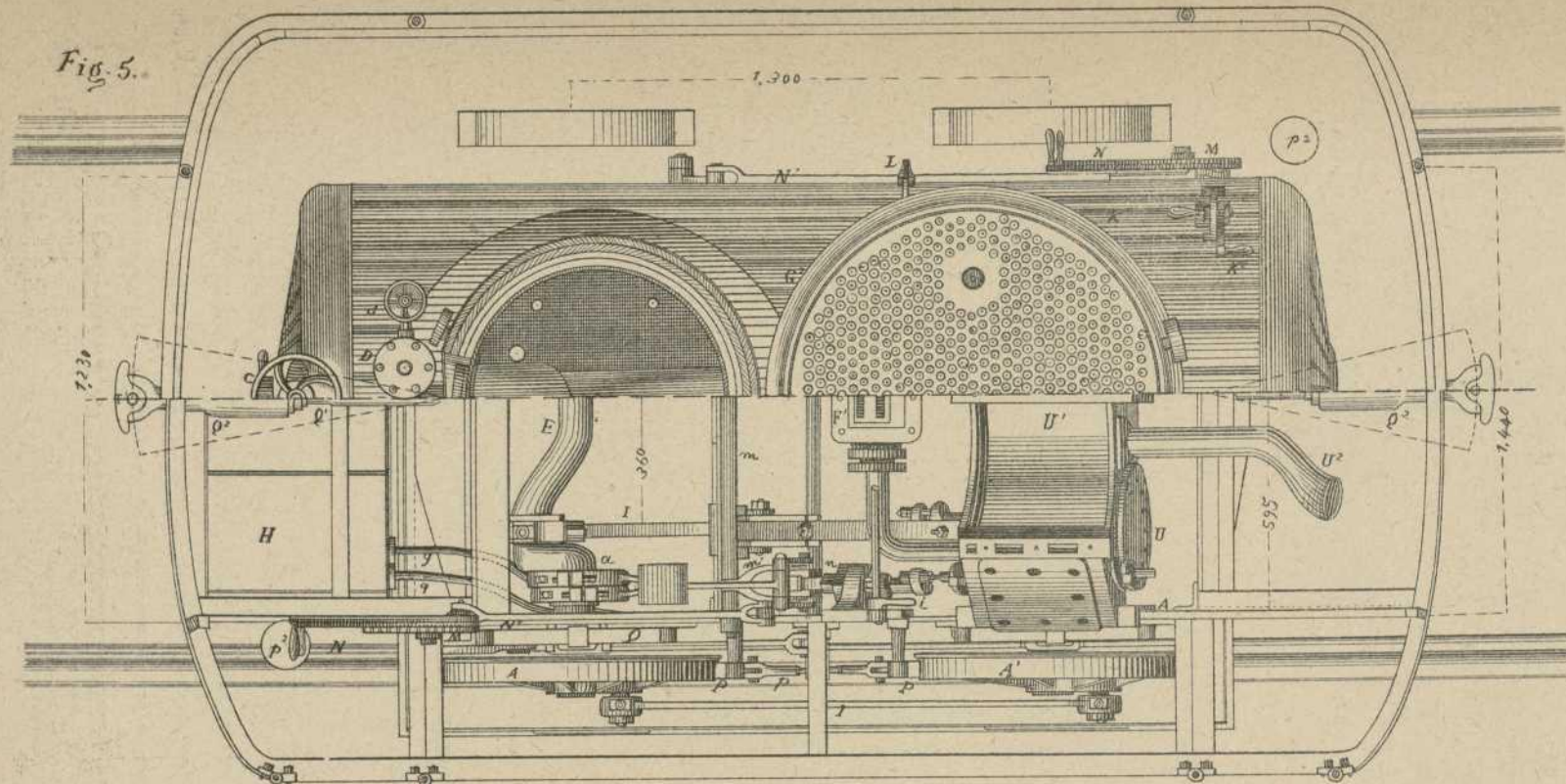


Fig. 6.

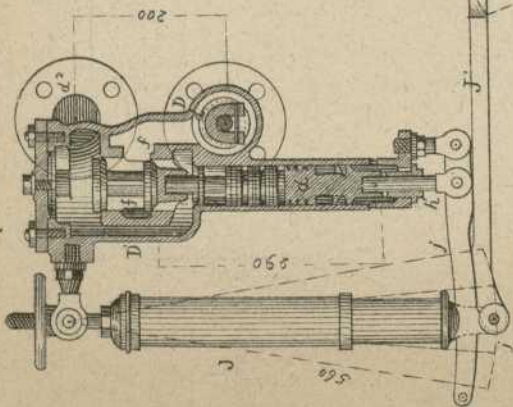


Fig. 7.

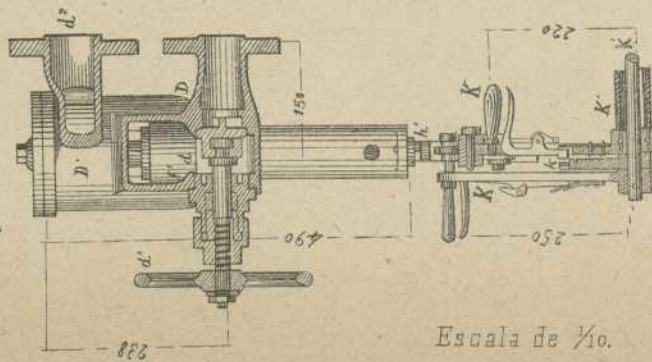
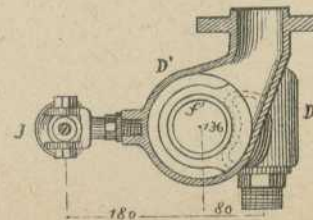
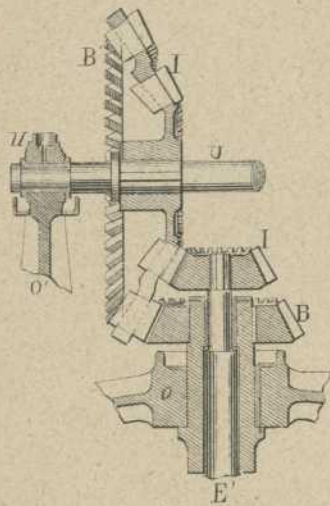


Fig. 8.



Escala de 1/10.

Fig. 5.



Corte por 1-2-3-4

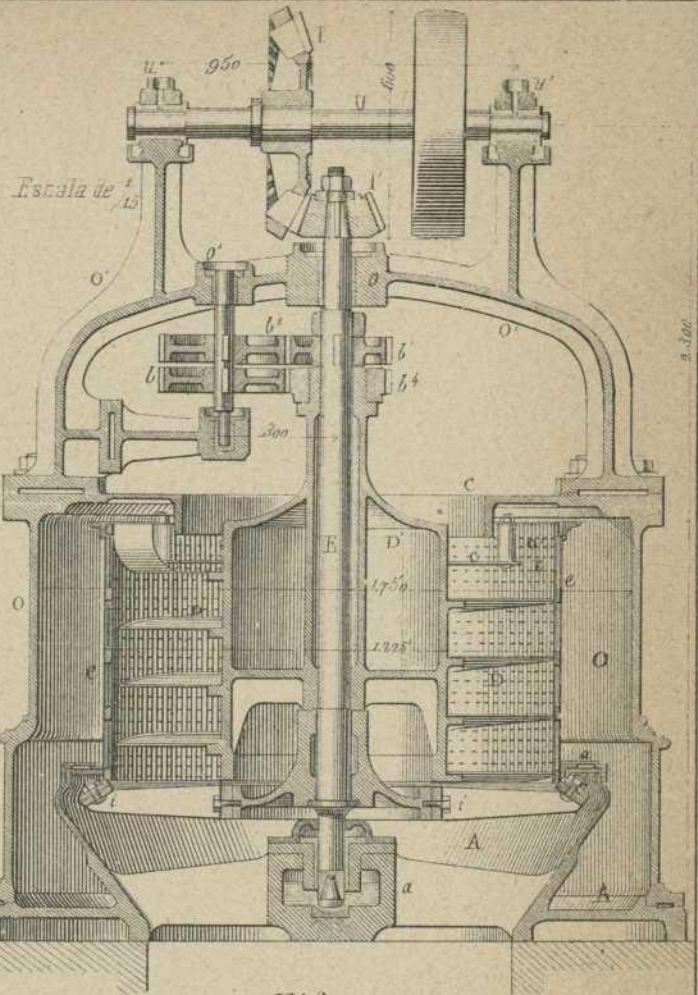


Fig. 1

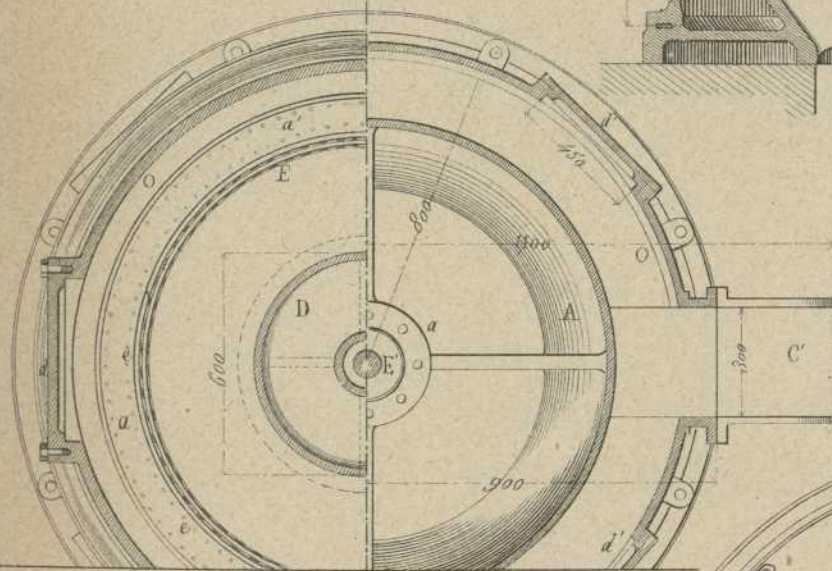


Fig. 4.

Escala de 1/20.

Fig. 2.

Visto por arriba.

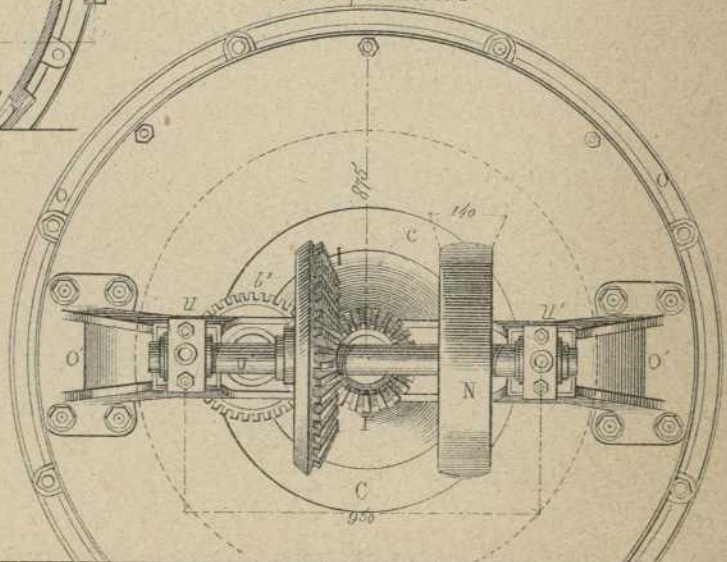
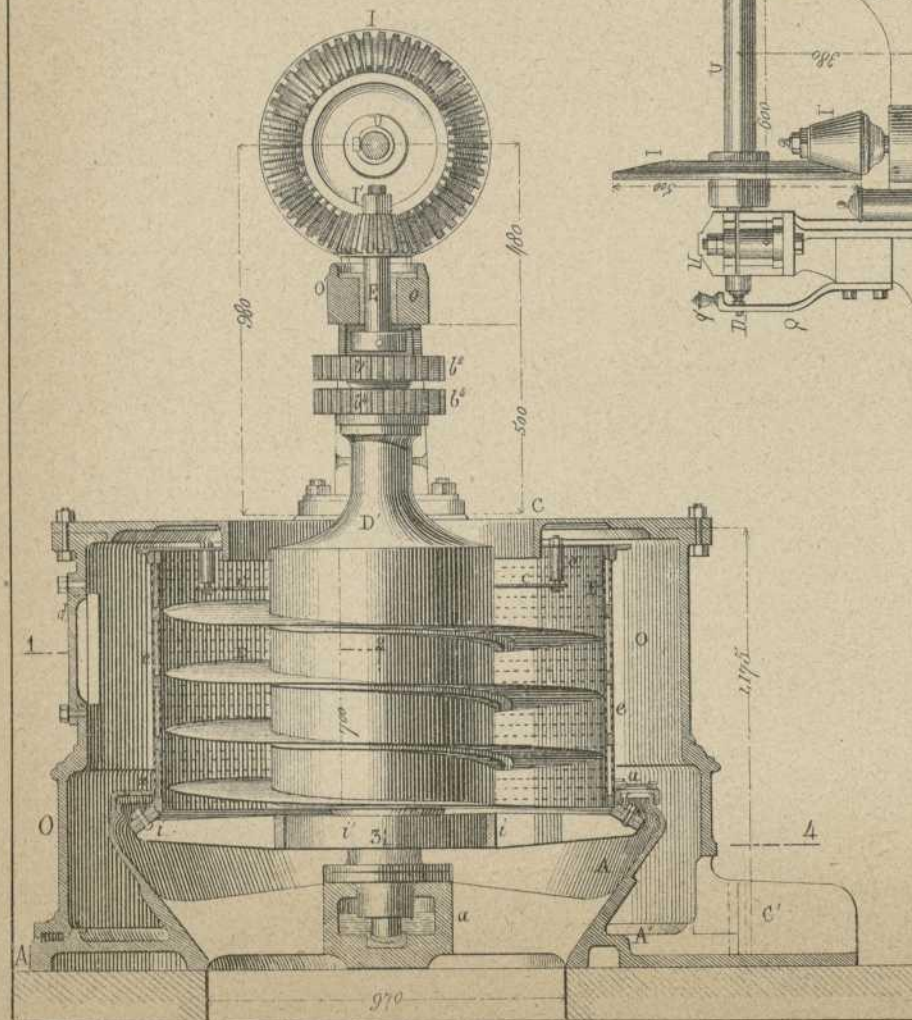


Fig. 3.



Nacente, editor.

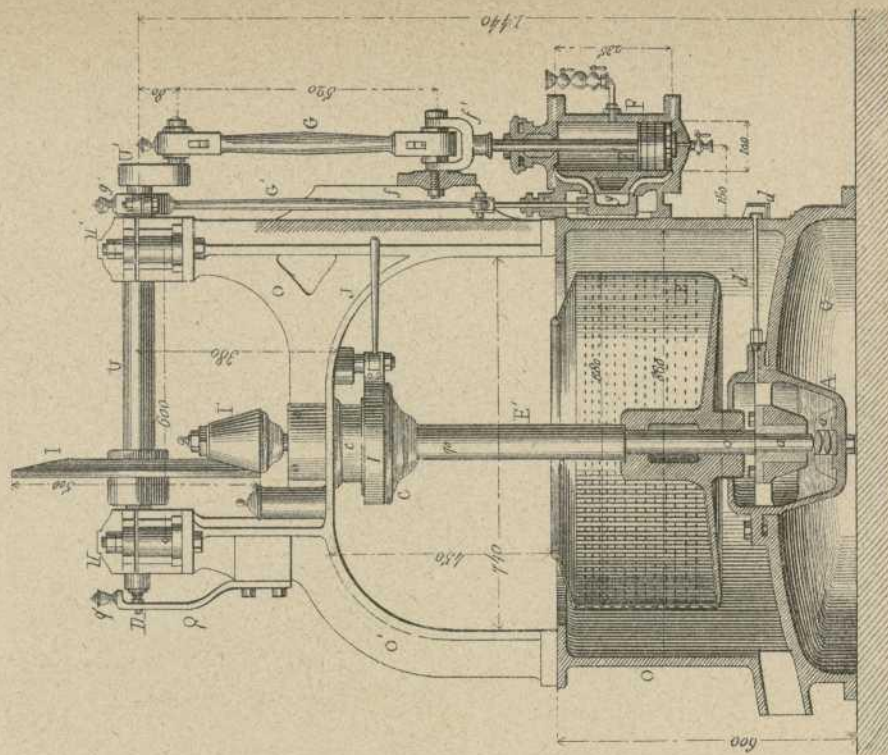
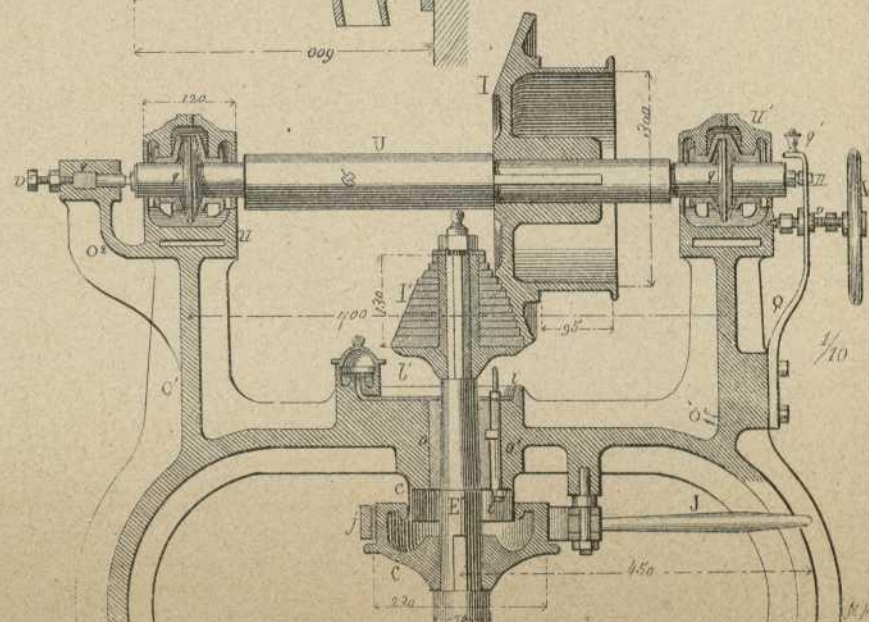
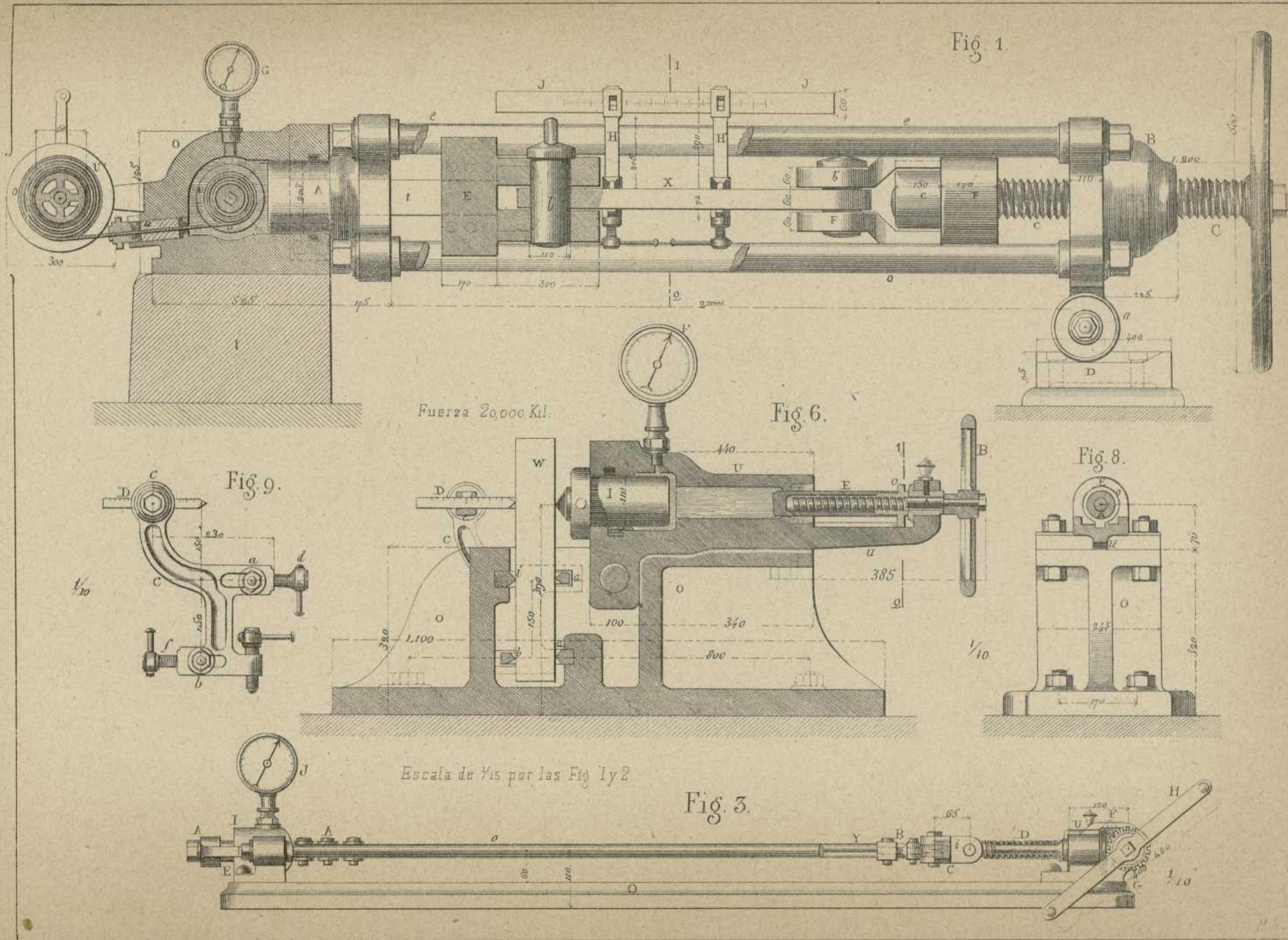


Fig. 6.

Fig. 7.



Peso de Gracia, 150.



Fuerza 20,000 Kil.

Escala de 1/10 por las Fig. 1 y 2

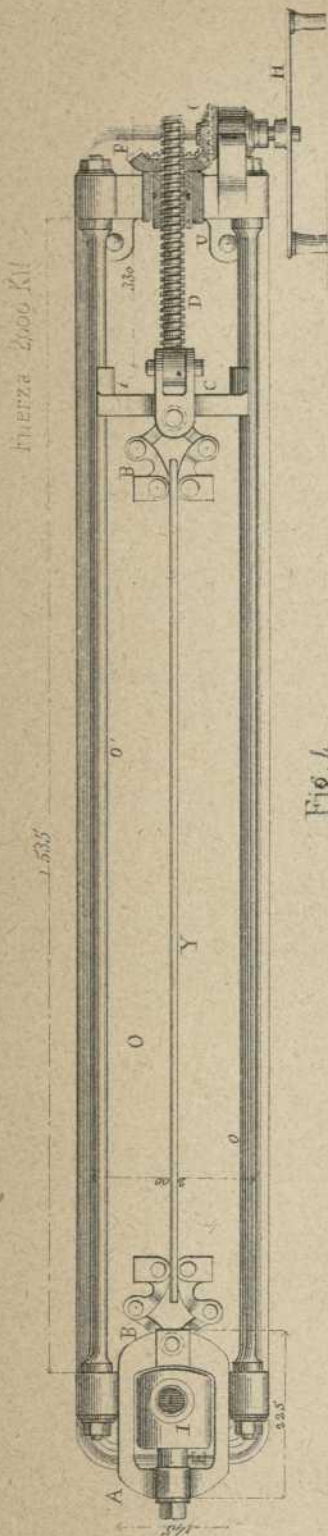


Fig. 4

Escala de 1/10 Fig. 10 y II.

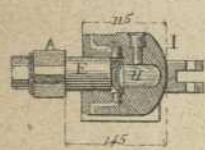


Fig. 5.

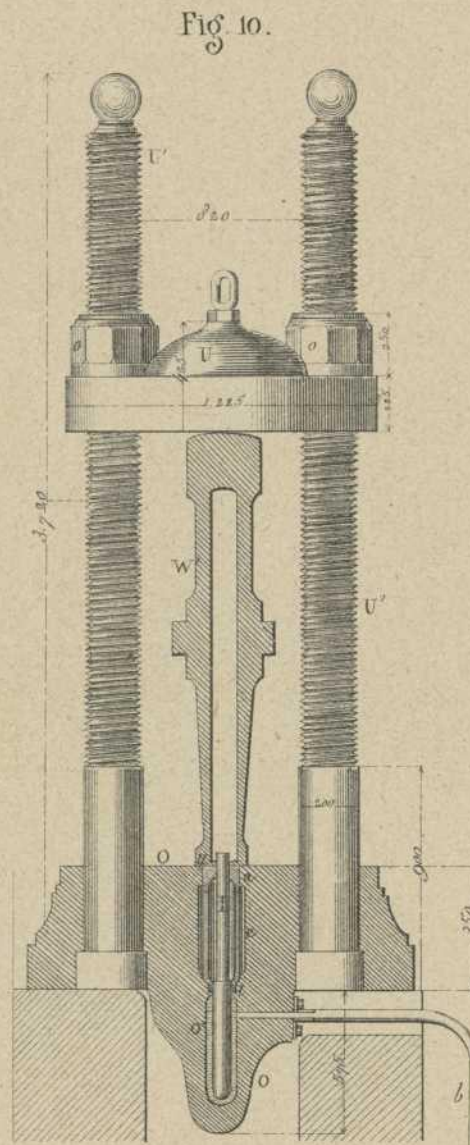


Fig. 10.

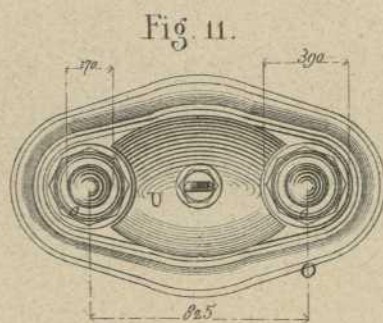


Fig. 11.

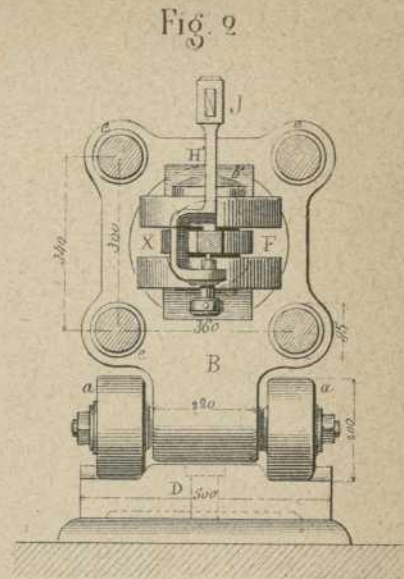


Fig. 2

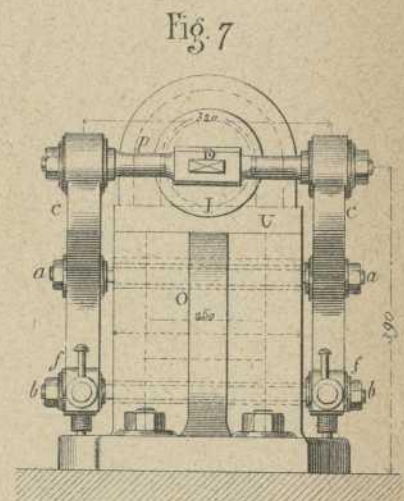


Fig. 7

Presion de los compresores 350 atm
id en el tubo 1000 "

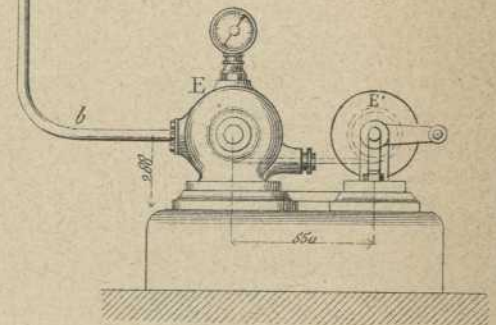


Fig. 1.

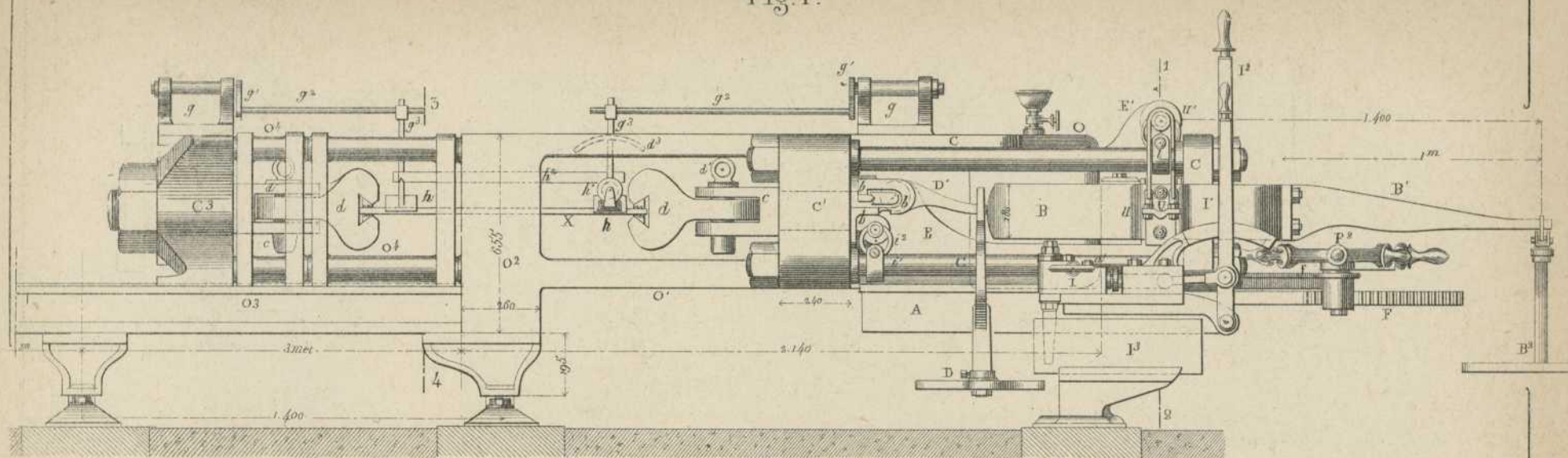
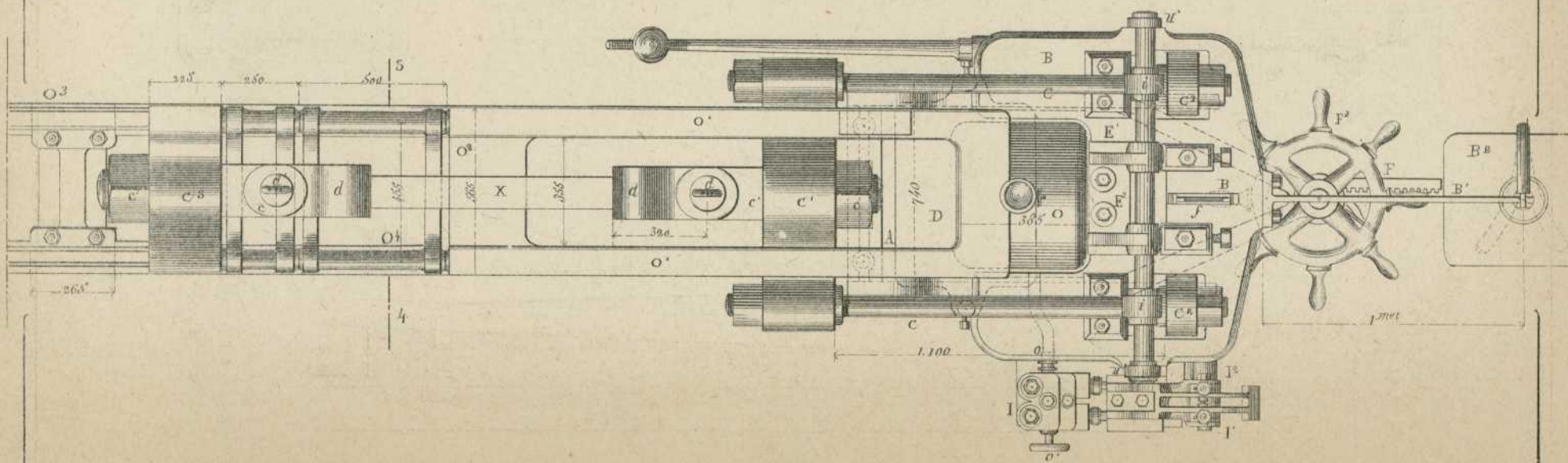
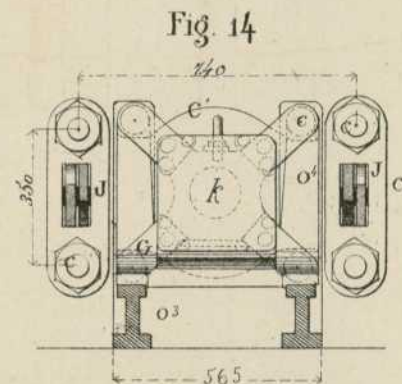
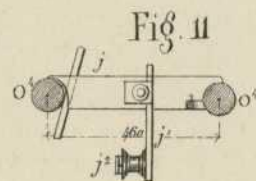
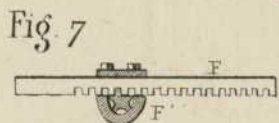
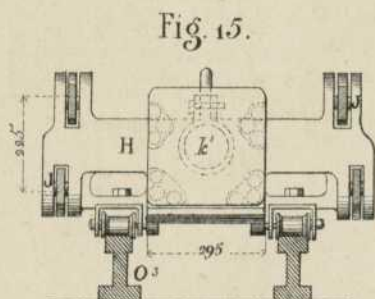
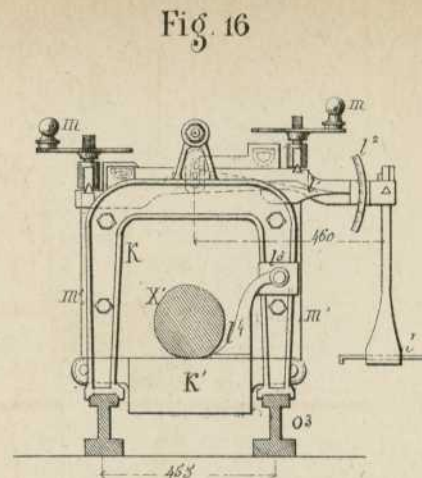
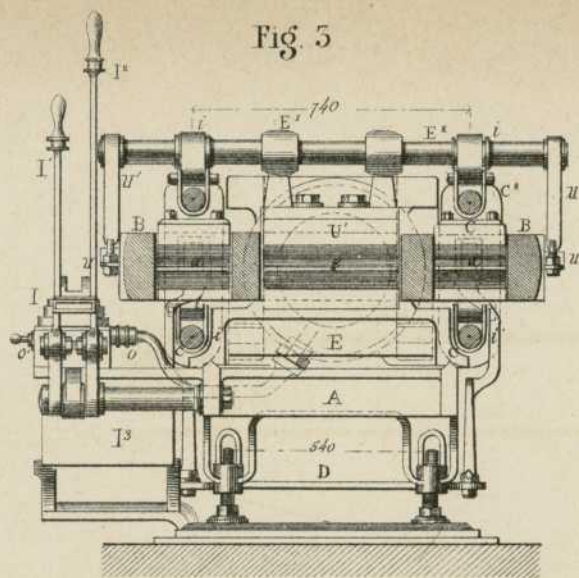
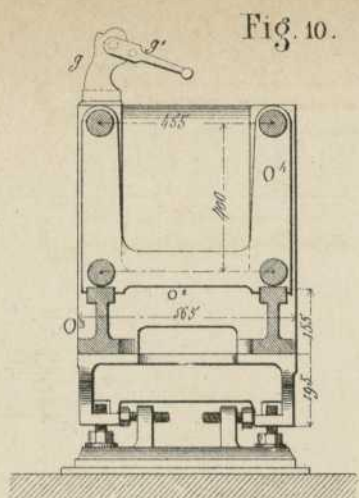
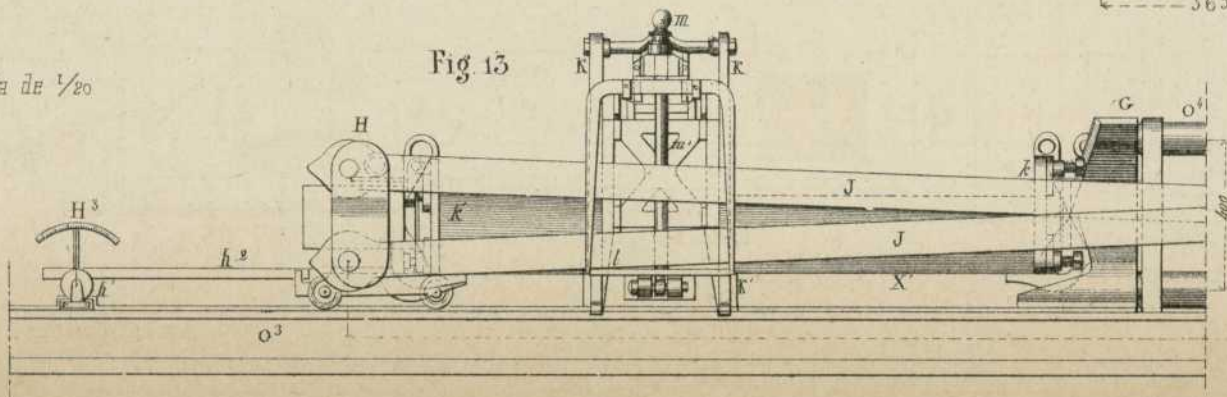


Fig. 2.





Escala de $\frac{1}{20}$



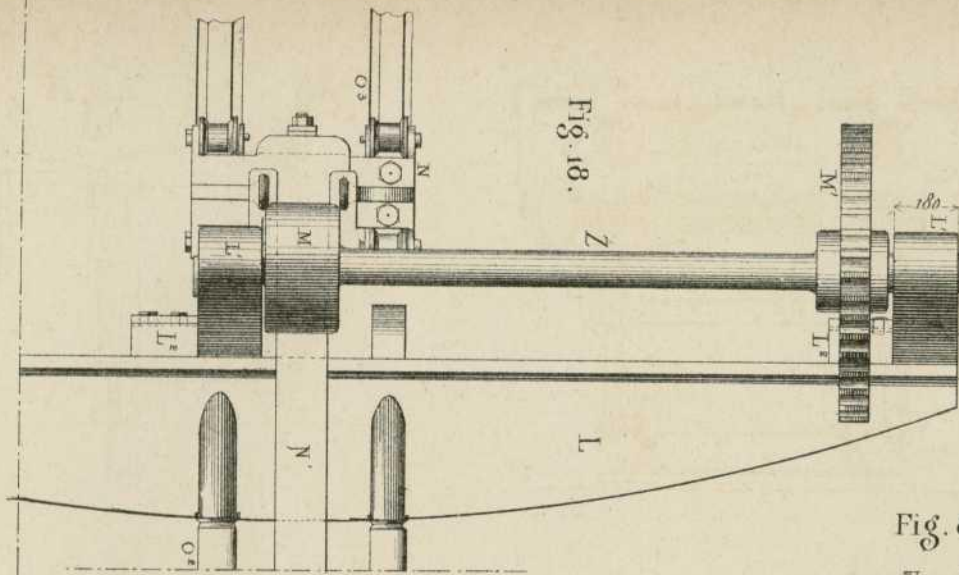


Fig. 18.

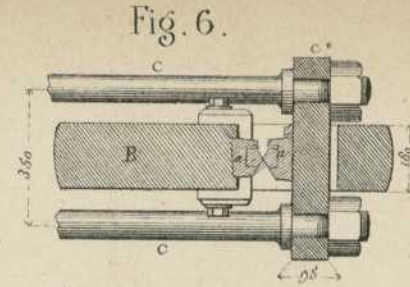


Fig. 6.

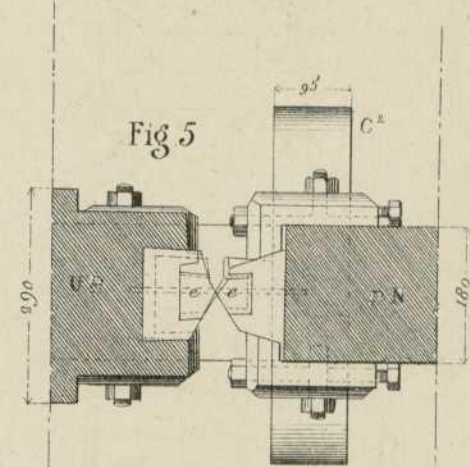


Fig 5

Escala de 1/10.

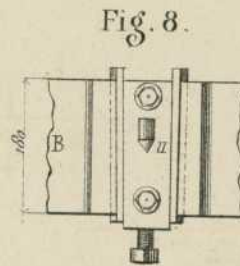


Fig. 8.

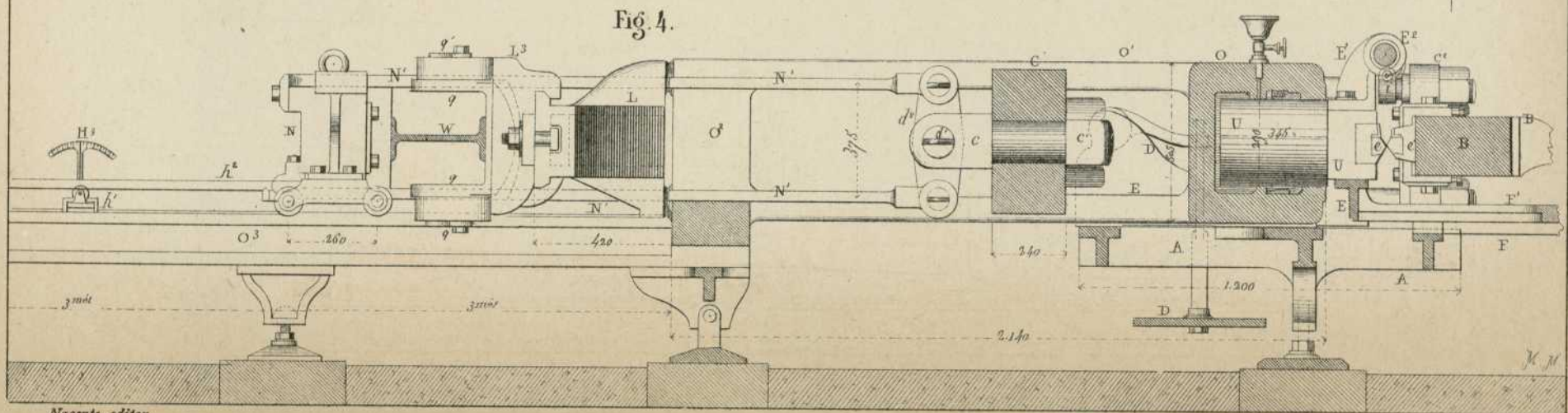


Fig. 4.

Fig. 19.

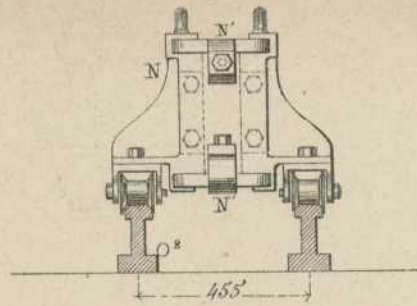


Fig. 17.

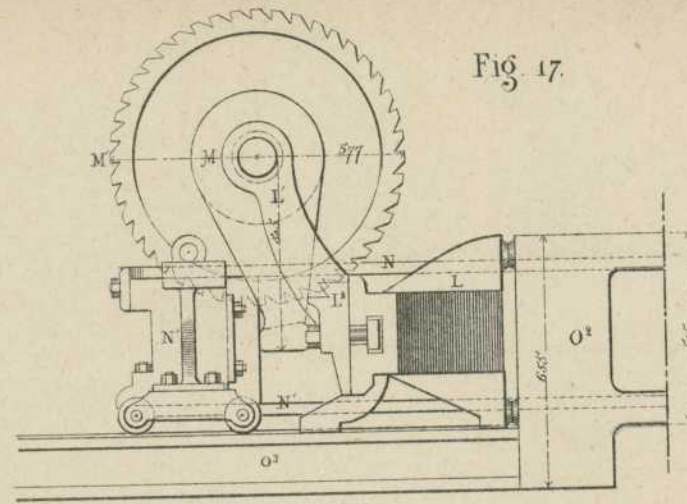


Fig. 9.



Fig. 22.

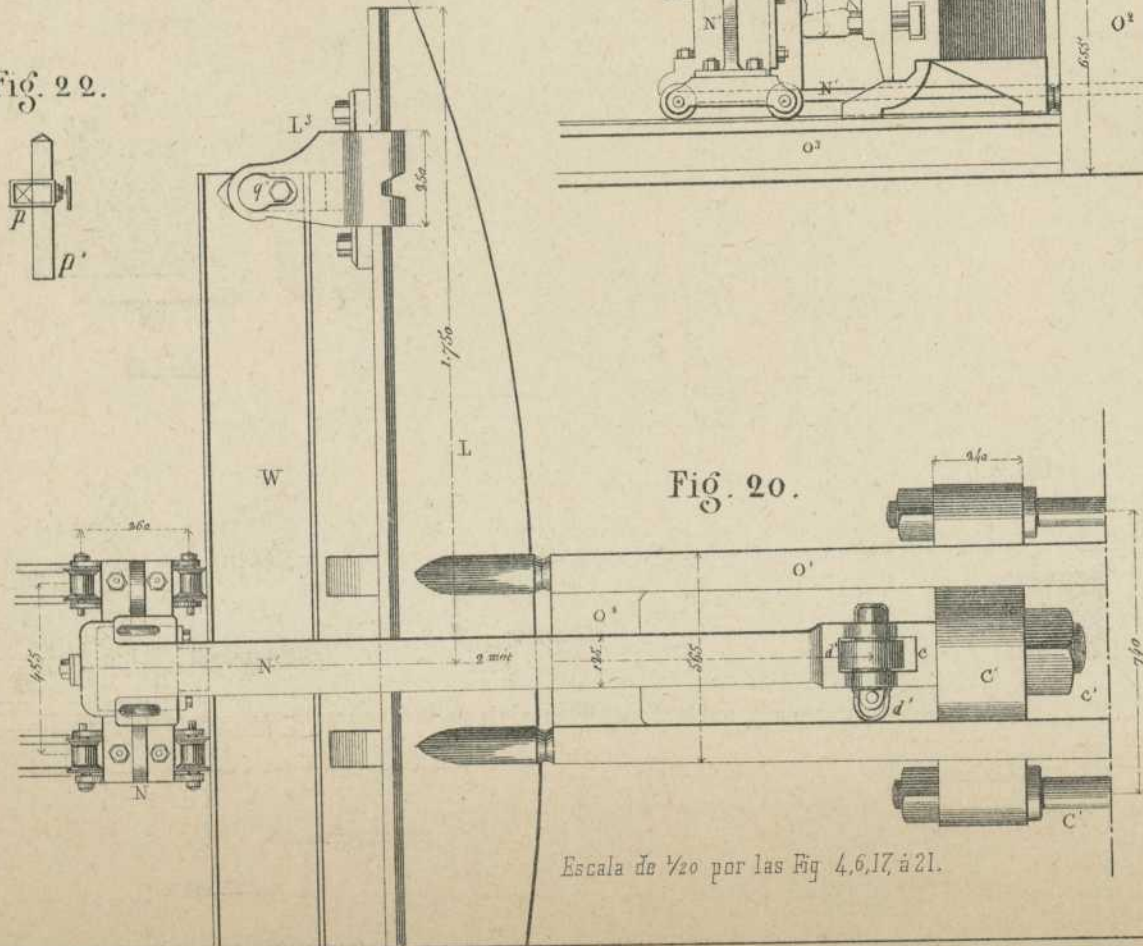
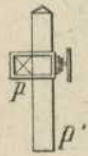
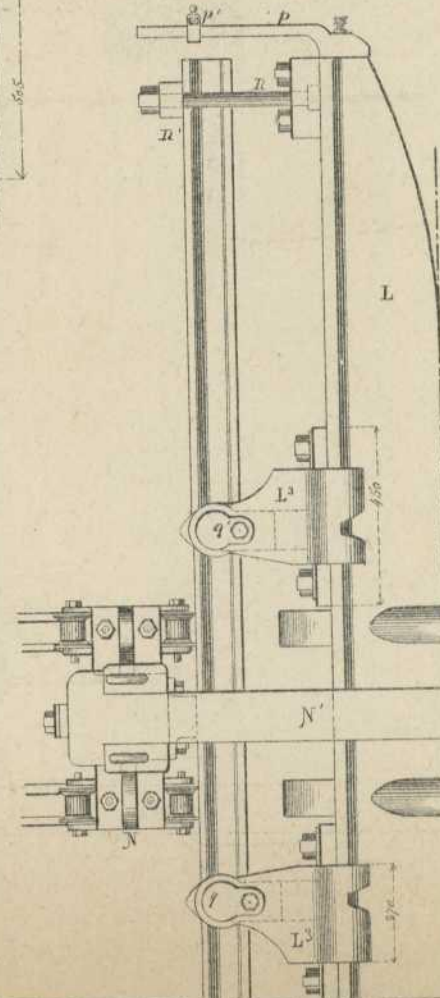
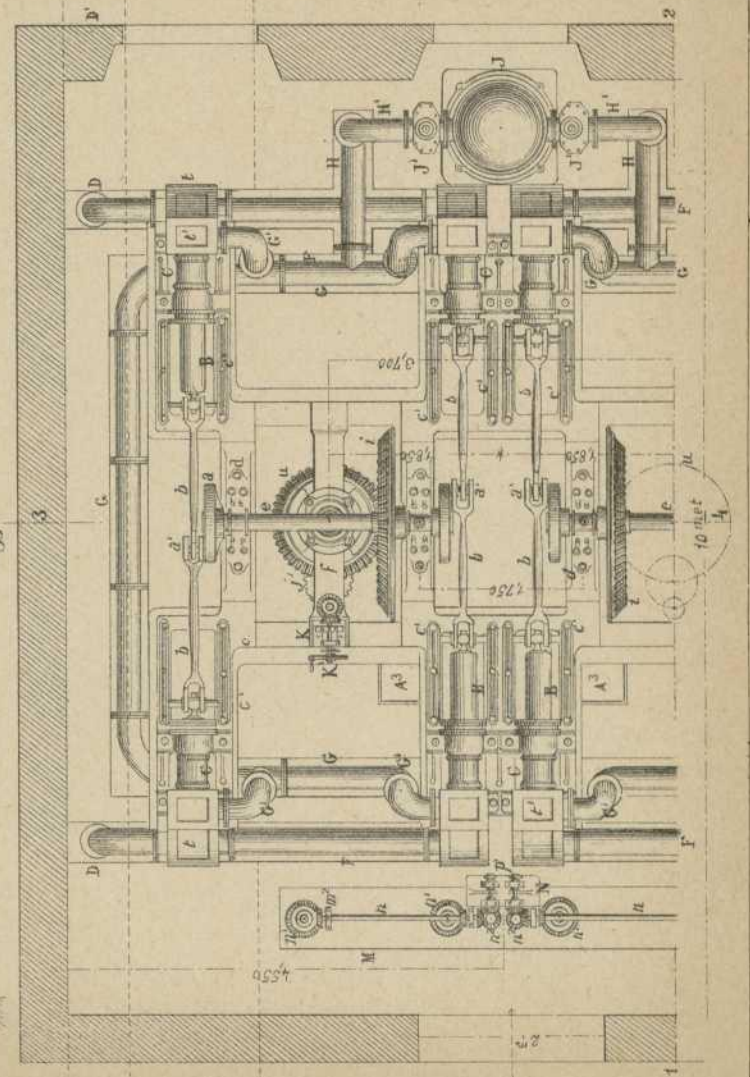
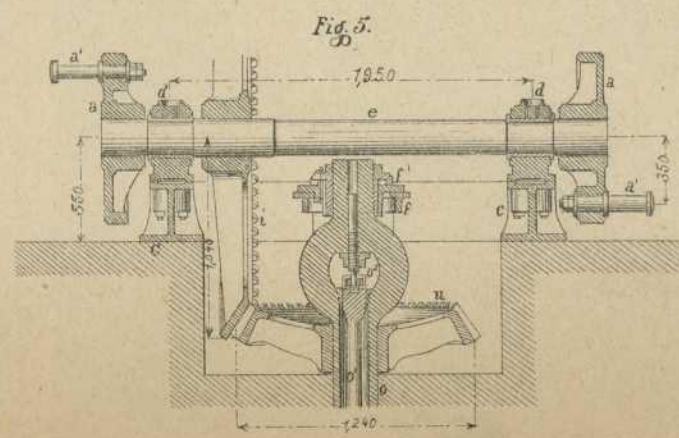
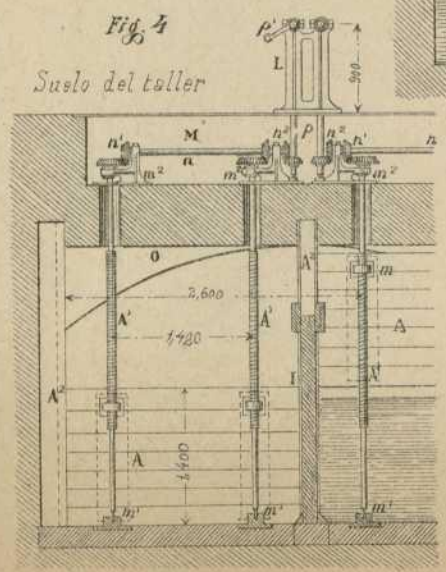
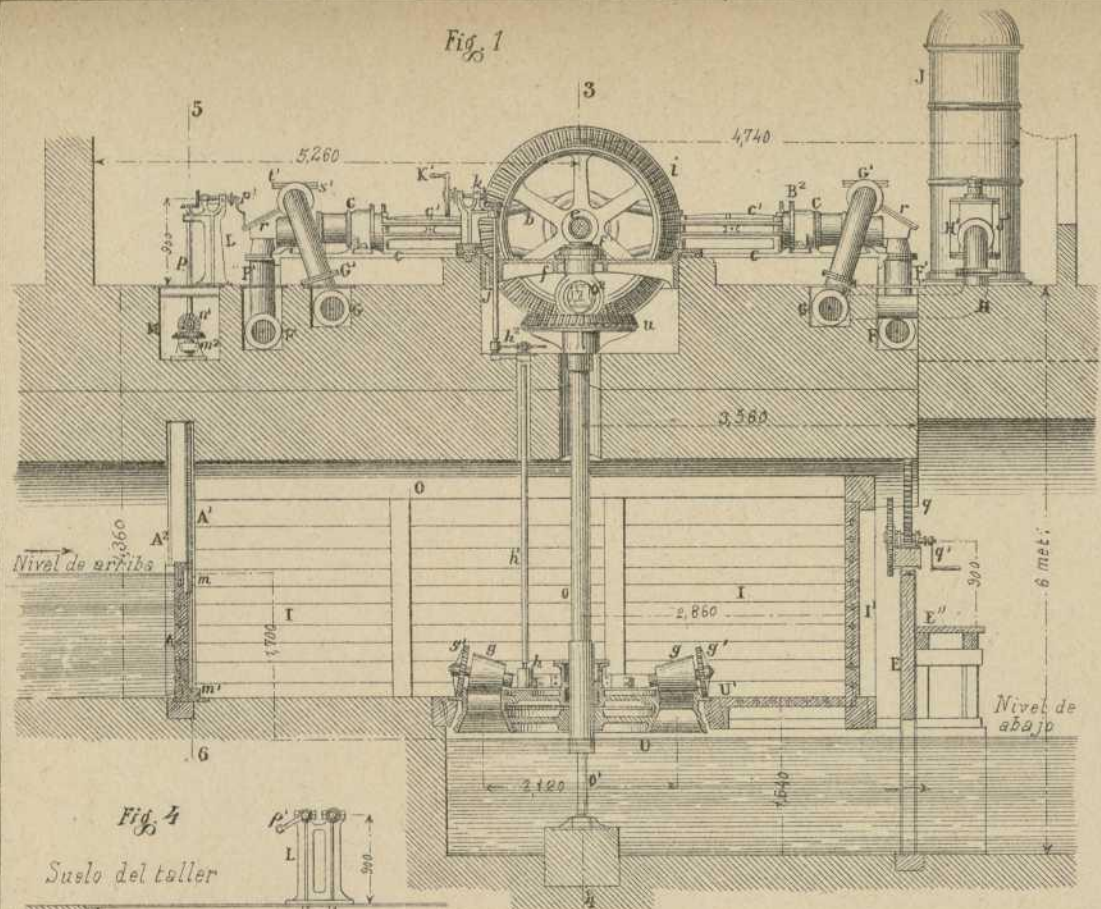


Fig. 20.

Escala de 1/20 por las Fig. 4, 6, 17, à 21.

Fig. 21.





Escala de $\frac{1}{80}$ por las Fig. 1 a 4

A

Fig. 3

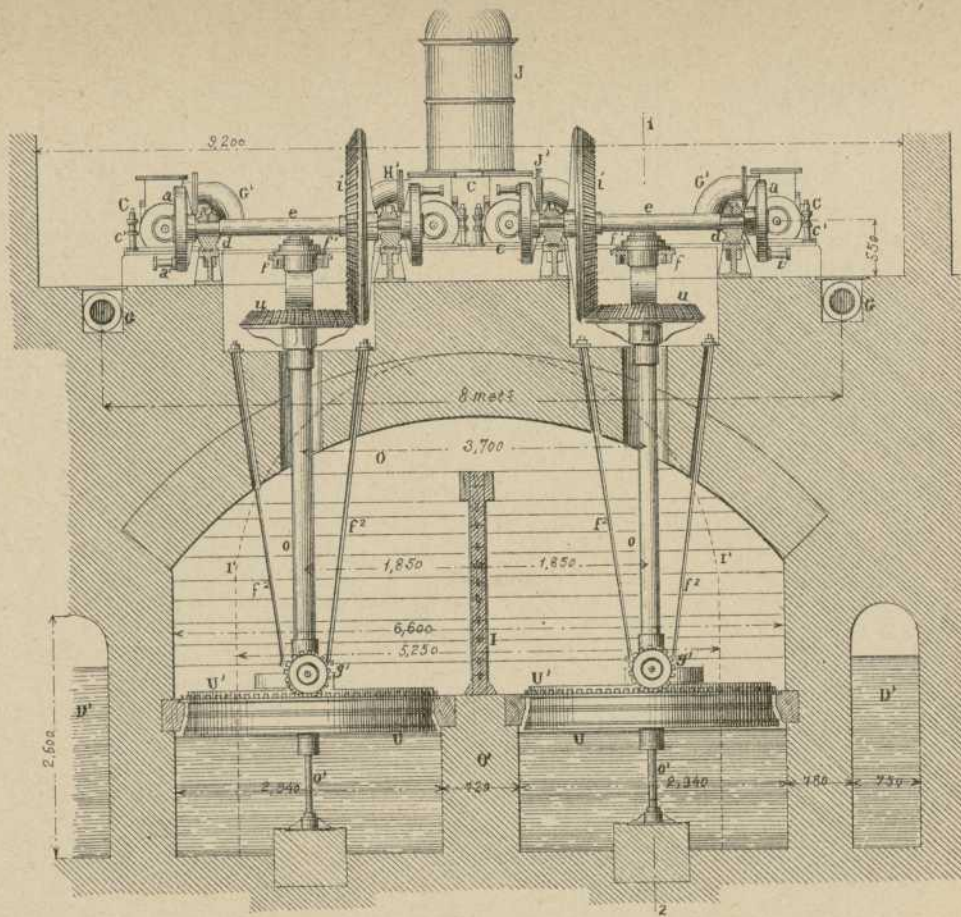


Fig. 8

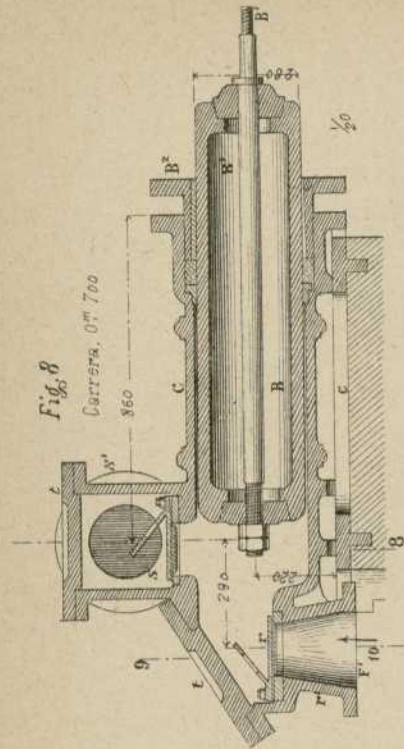


Fig. 6

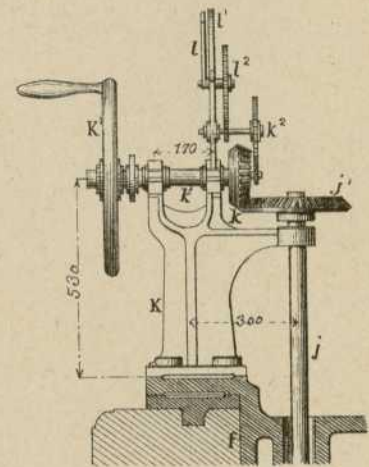


Fig. 9

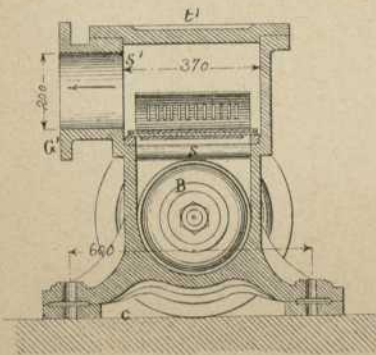


Fig. 7

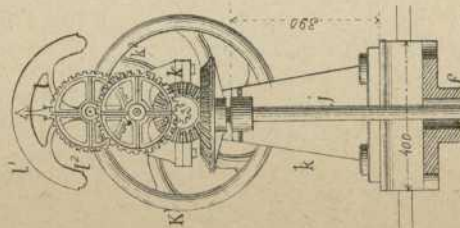
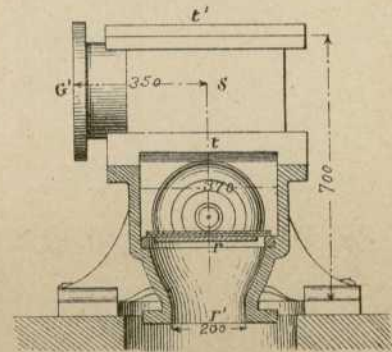
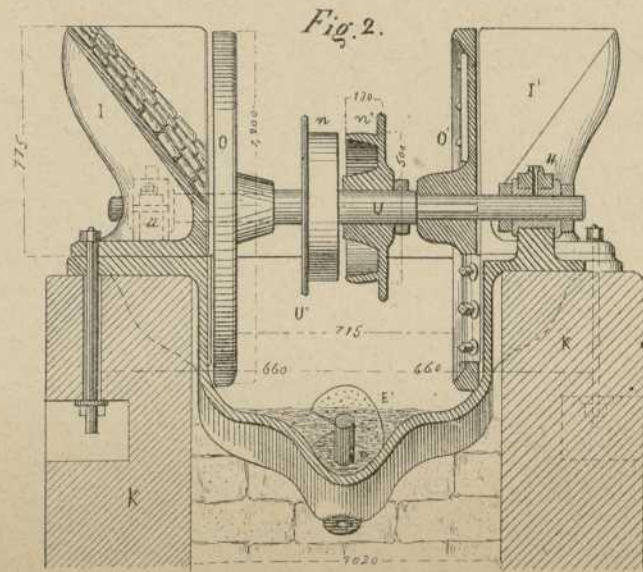
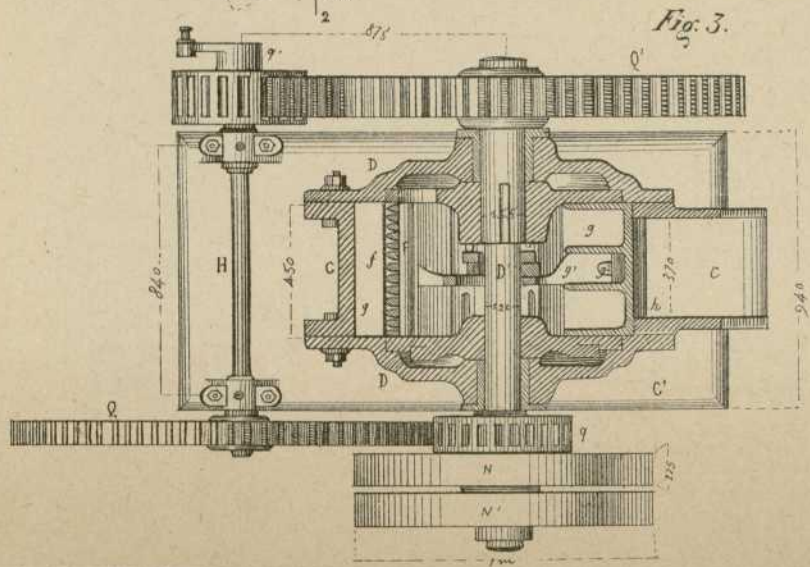
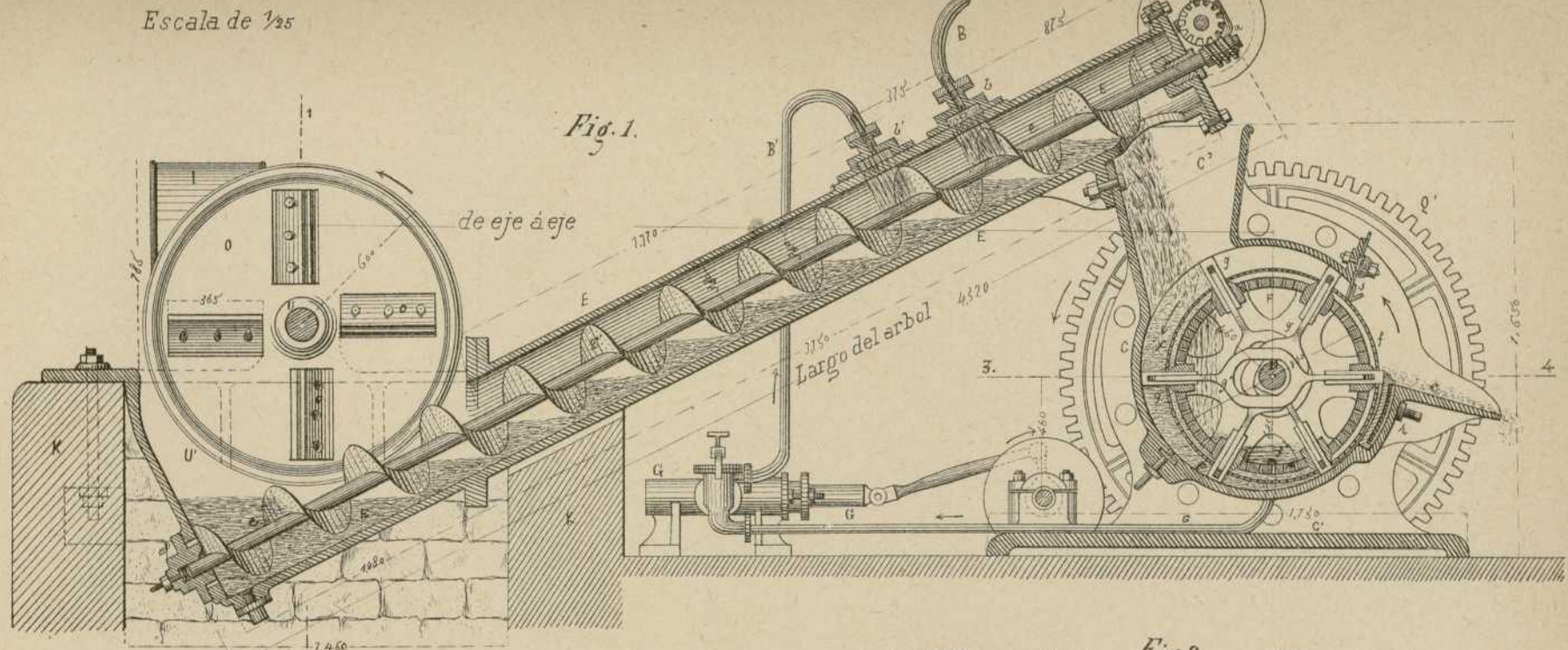
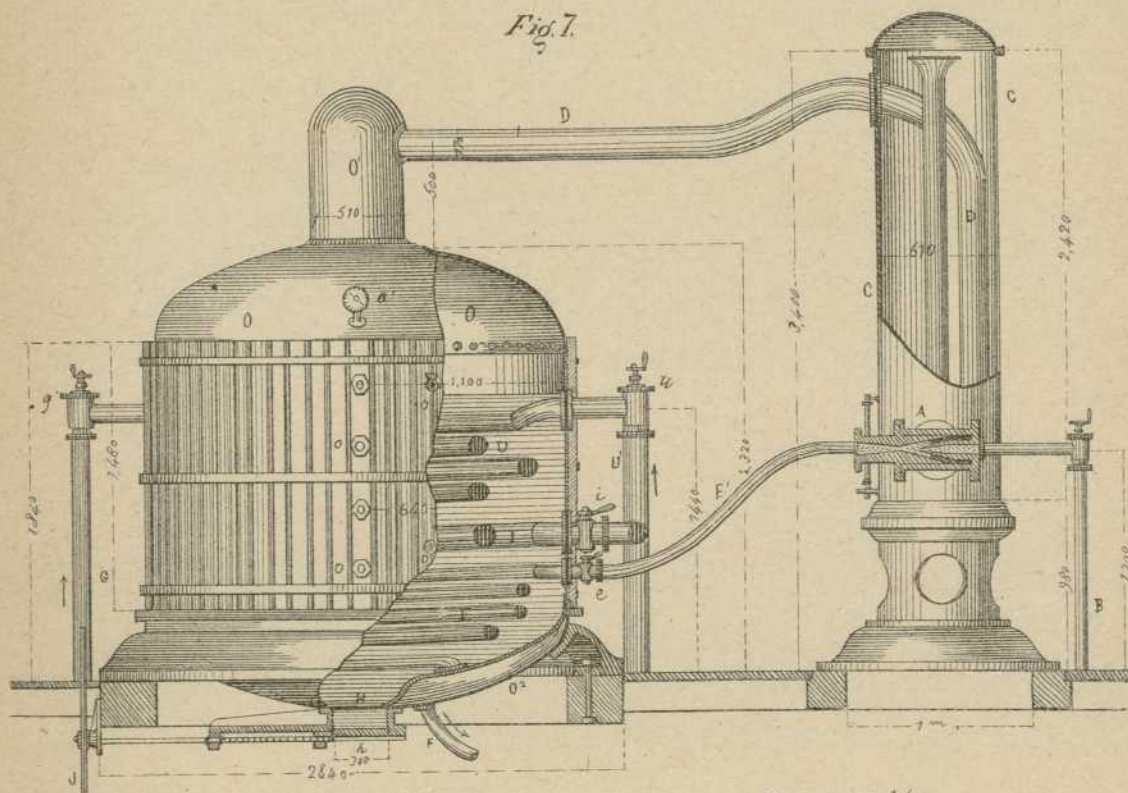
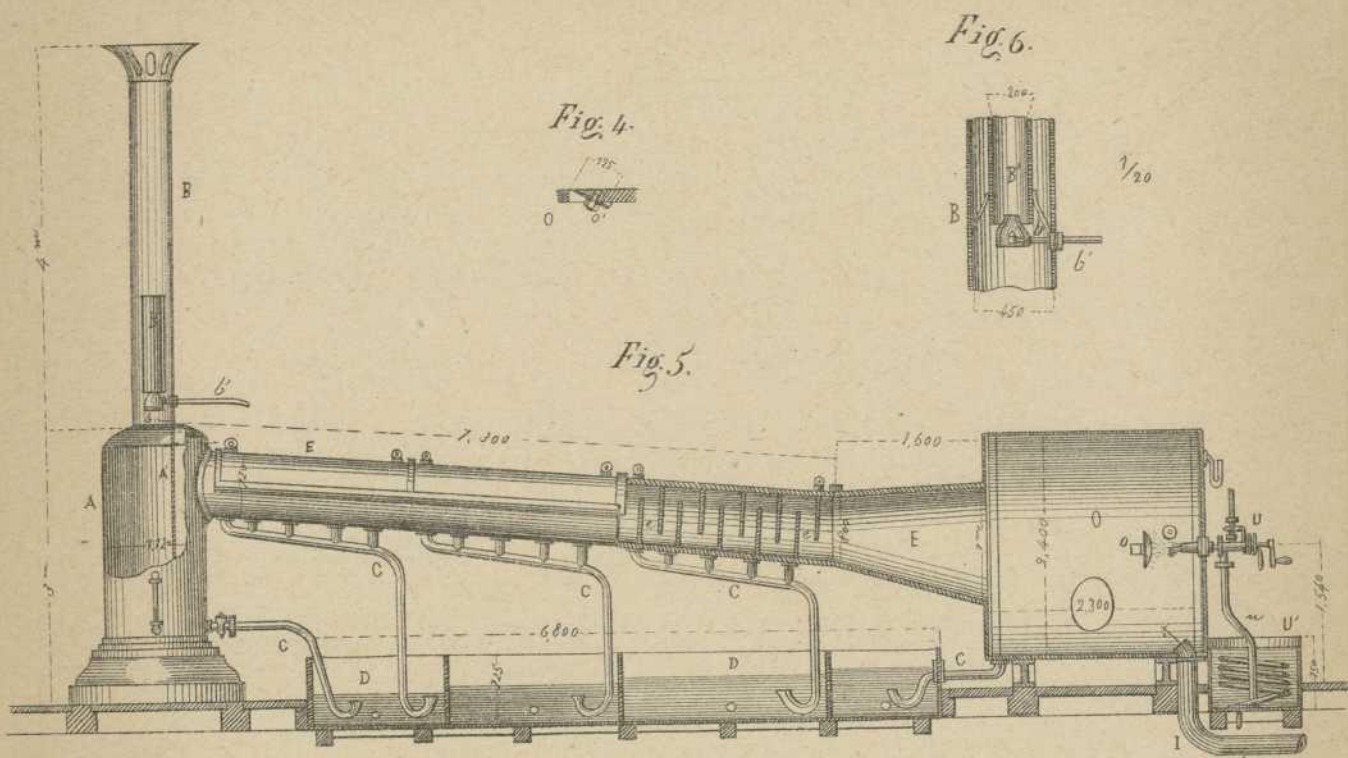


Fig. 10



Escala de $\frac{1}{25}$

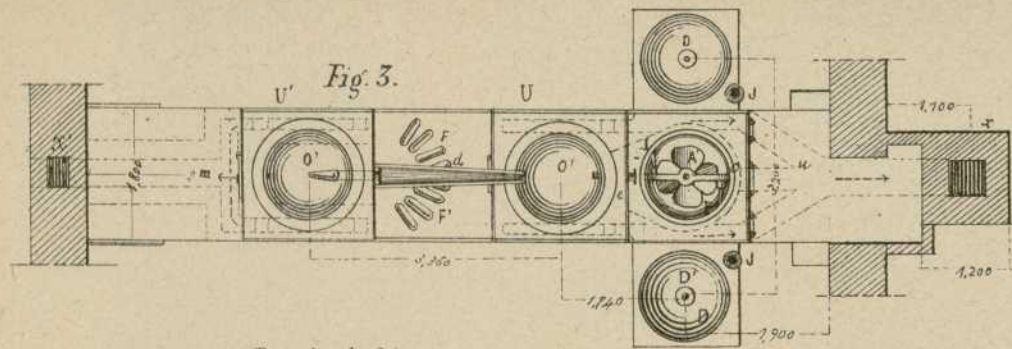




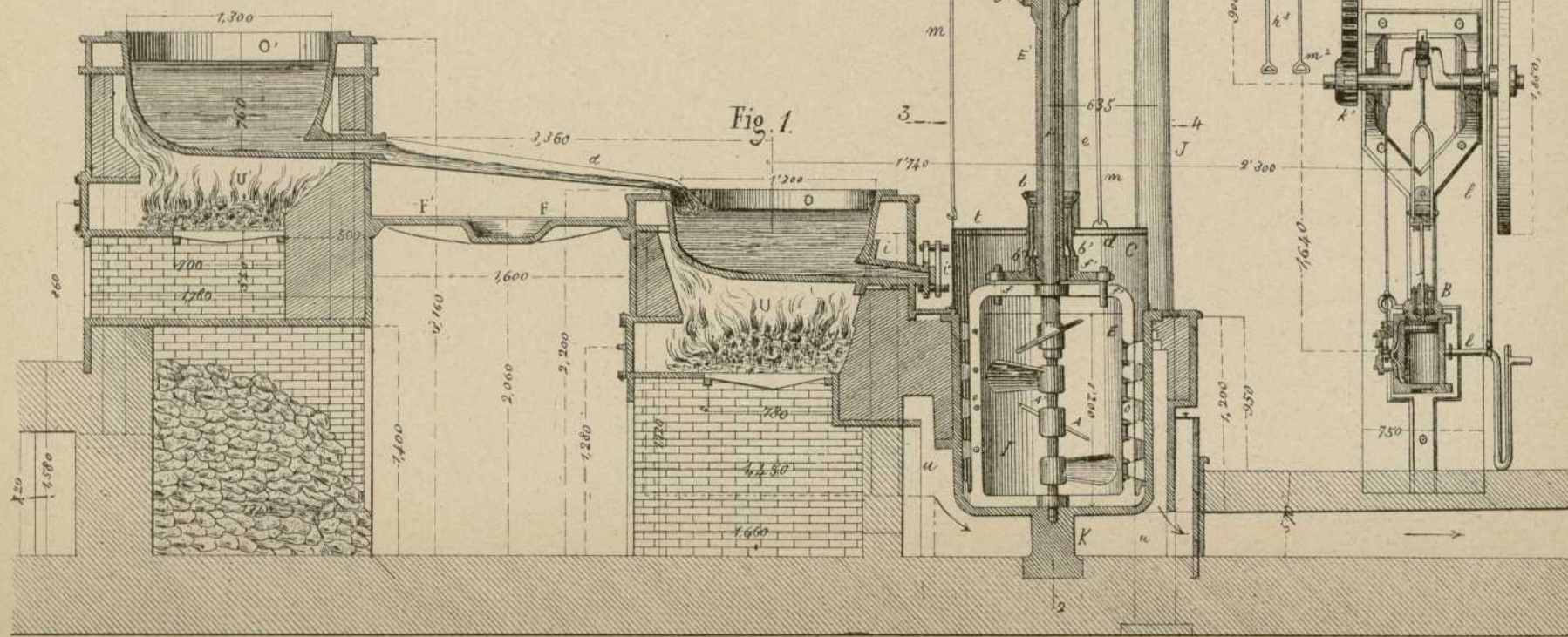
Escala de 1/80

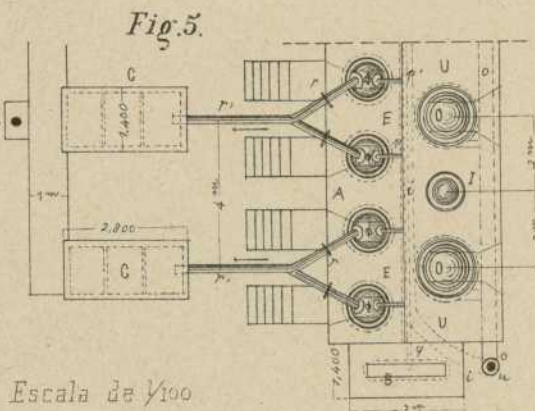
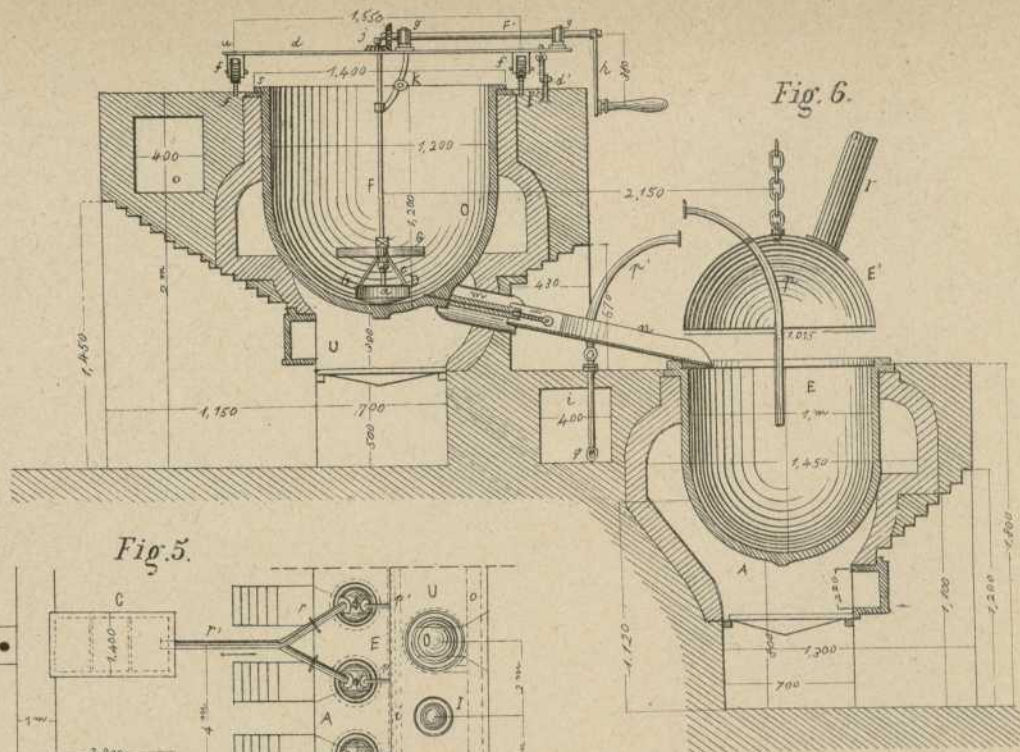
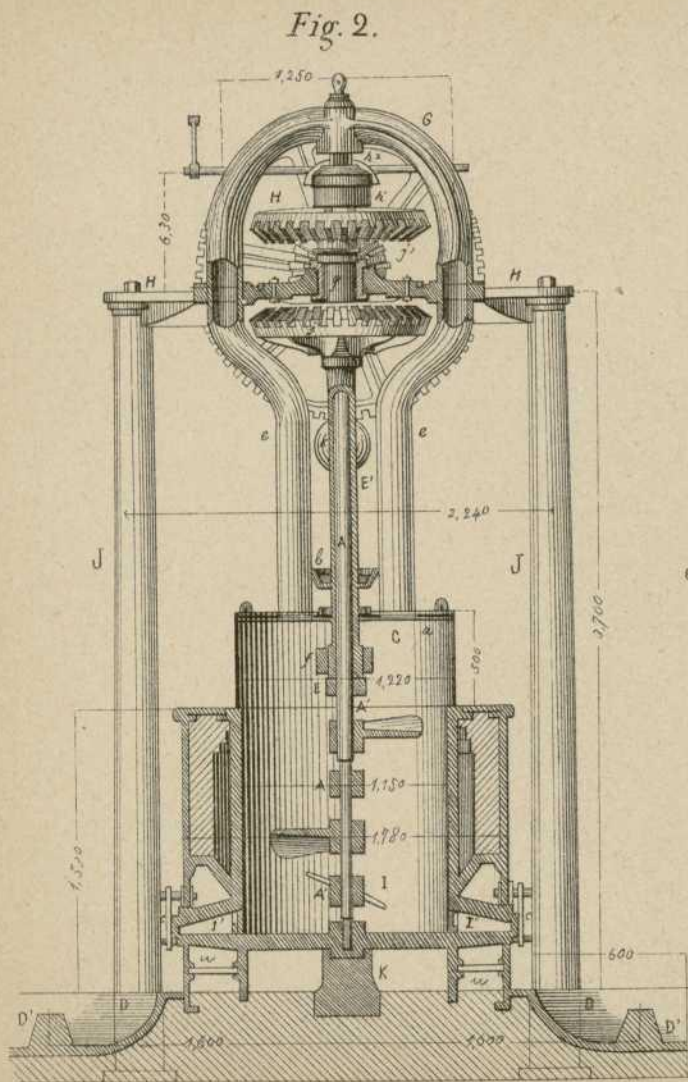
CF

Escala de $\frac{1}{40}$ por las Fig 1, 2, y 6.



Escala de $\frac{1}{100}$





Escala de 1/100

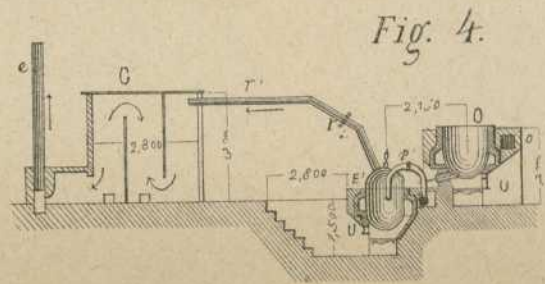


Fig. 1.

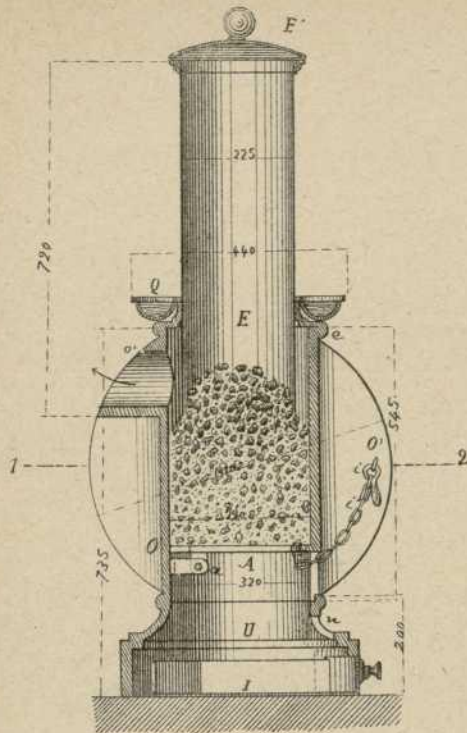


Fig. 2.

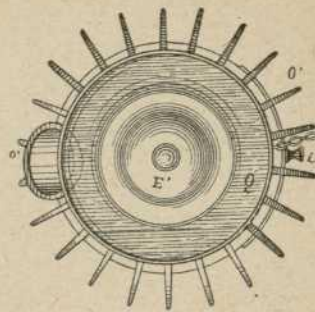


Fig. 3.

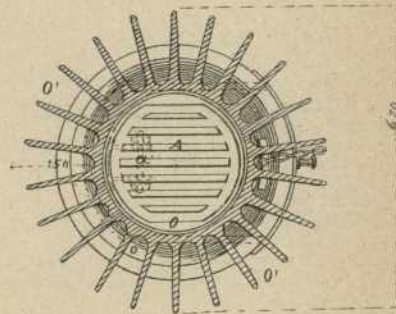


Fig. 4.

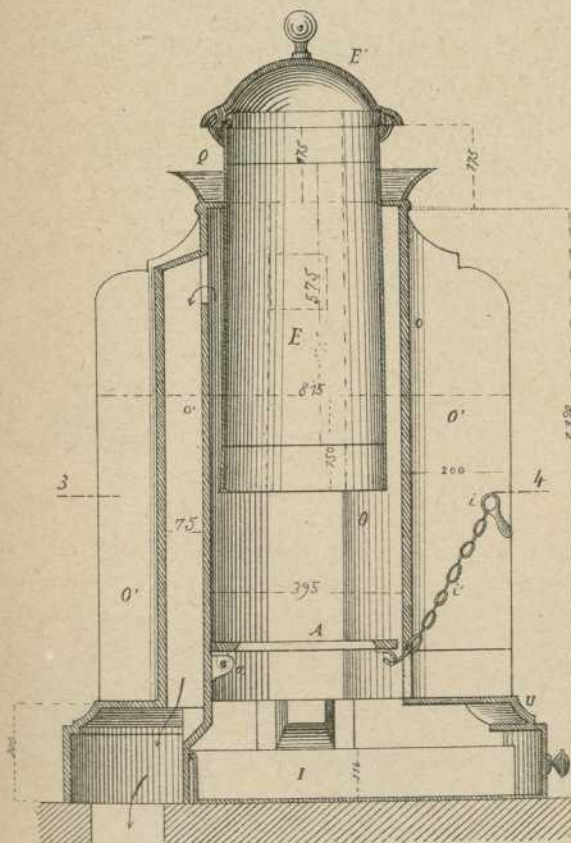
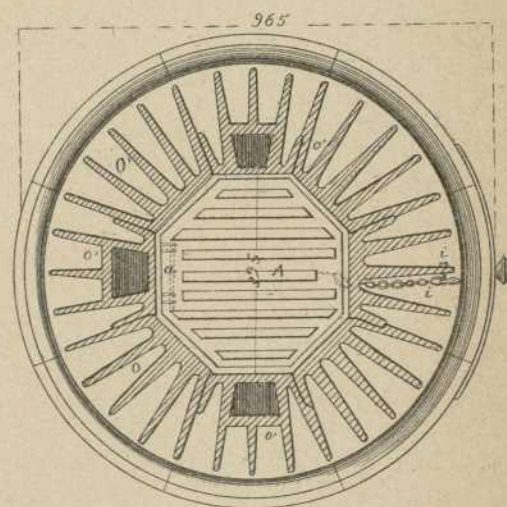


Fig. 5.



Escala de $\frac{1}{8}$

cent. 10 3 4 5 6 7 8 9 10 Dec.

1 Met.

Fig. 6.

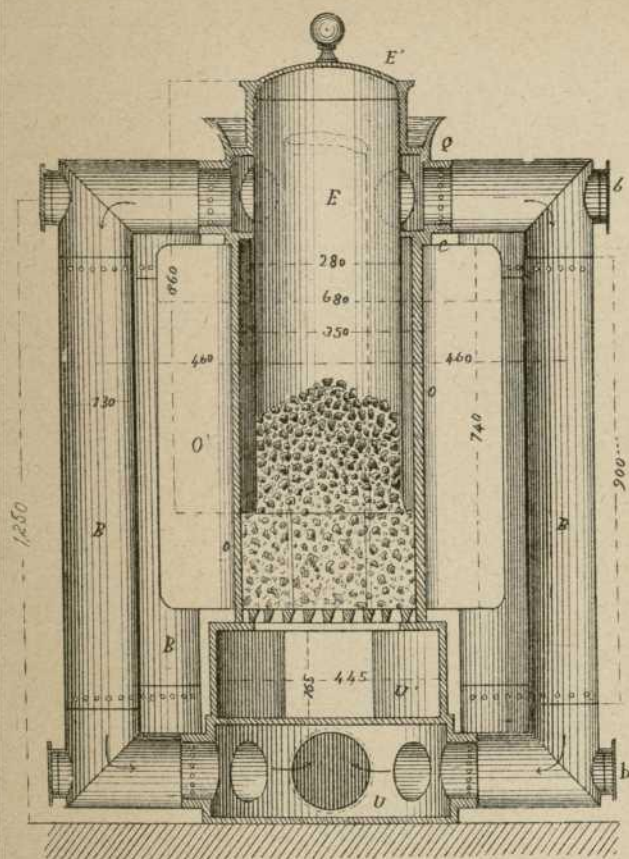


Fig. 7.

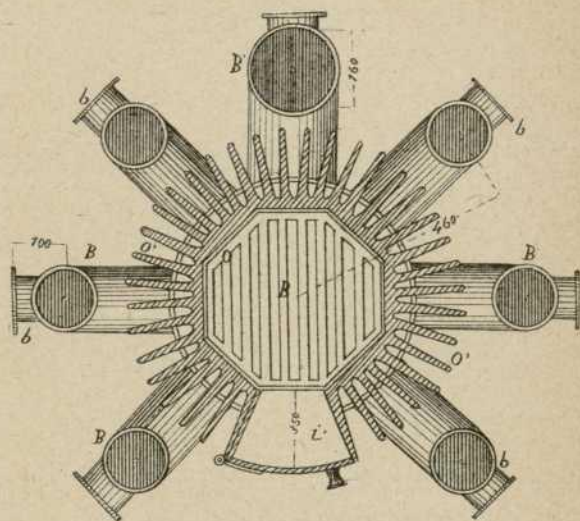


Fig. 8.

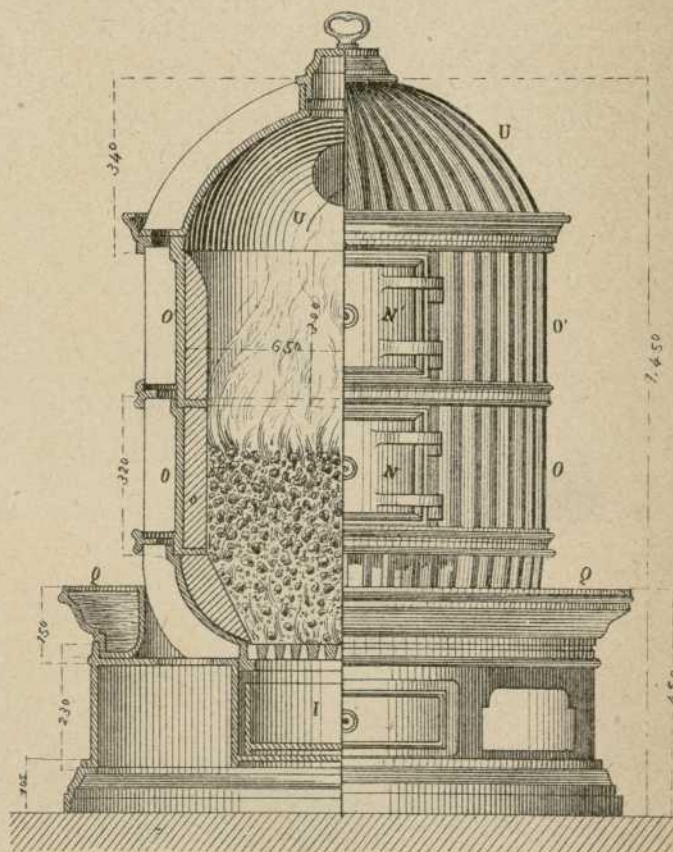
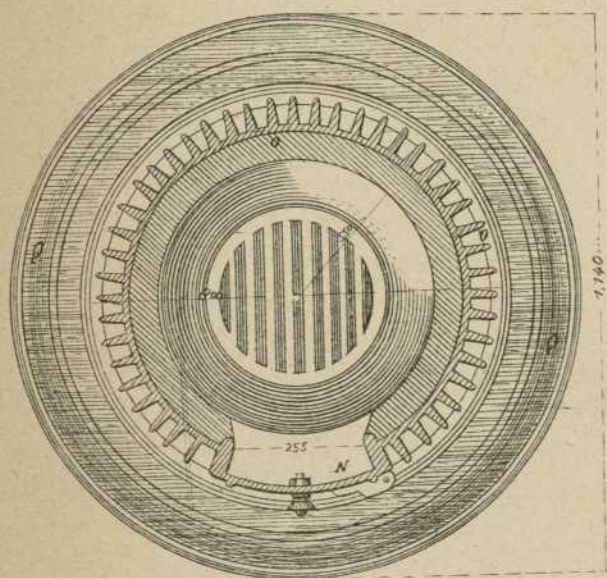


Fig. 9.



Escala de $\frac{1}{8}$

Centim. 5 7 2 3 4 5 6 7 8 9 10 Dec.

Met.

J.

Fig. 4

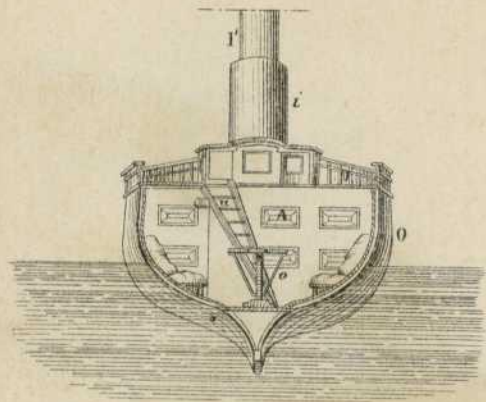


Fig. 1

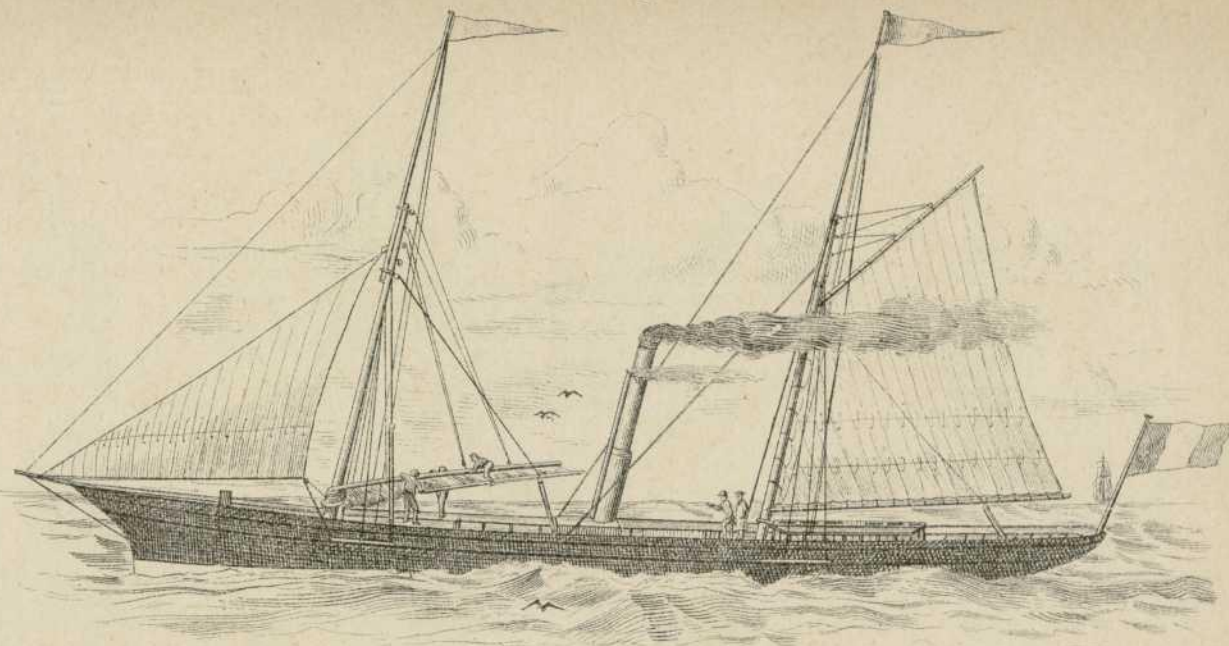


Fig. 3

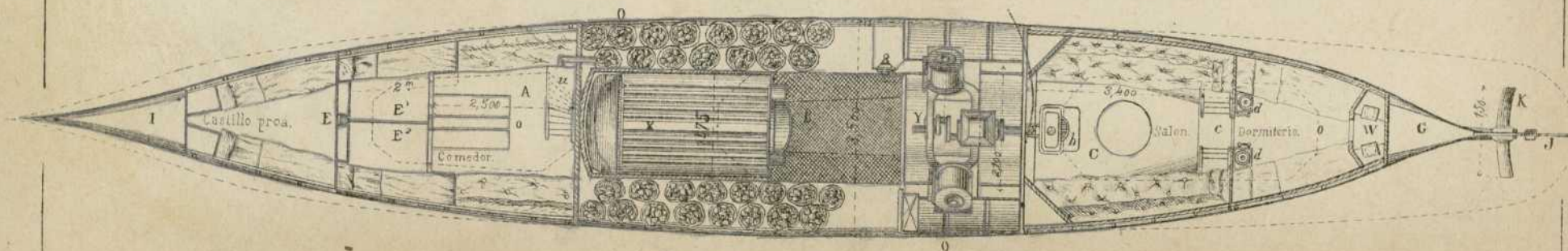


Fig. 2

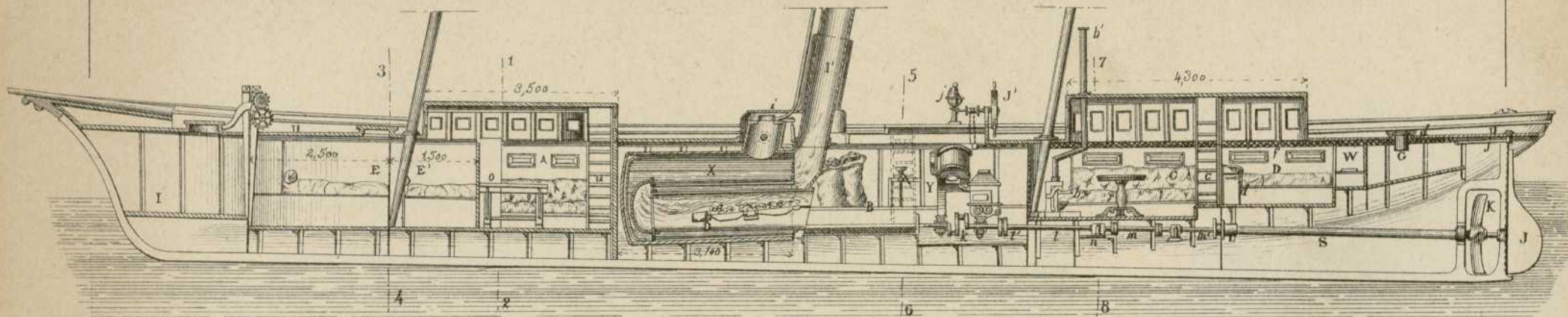


Fig. 7

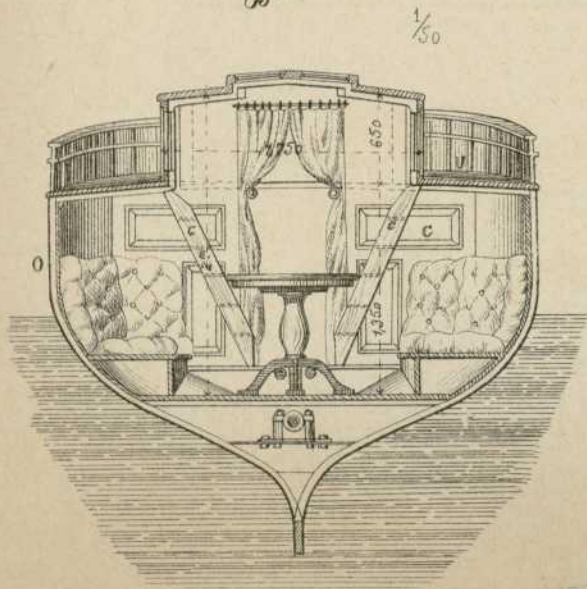


Fig. 5

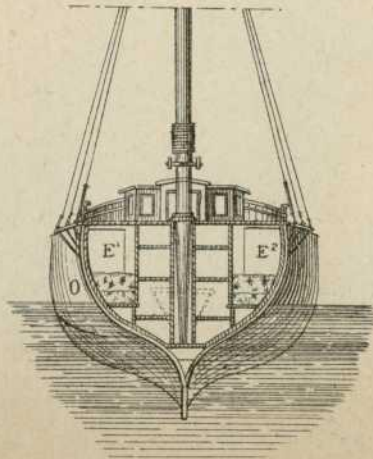
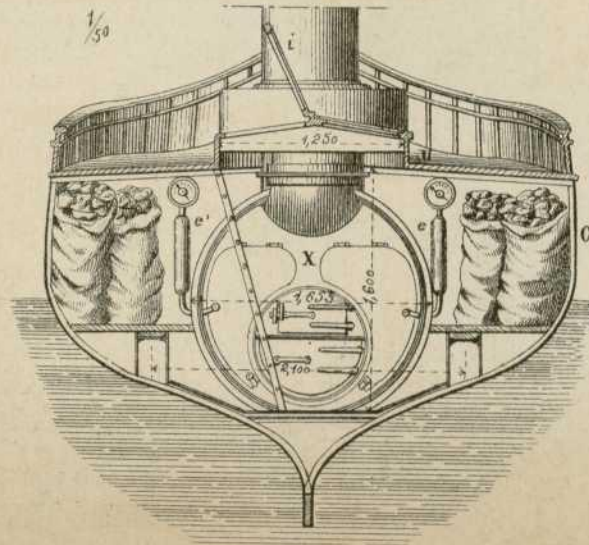
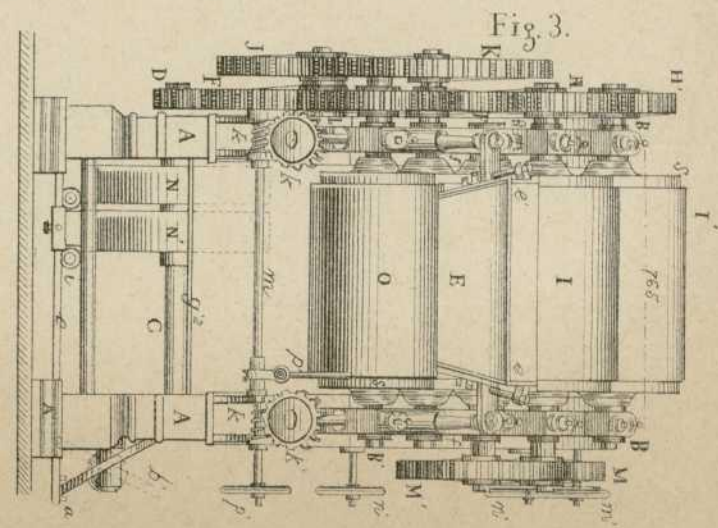
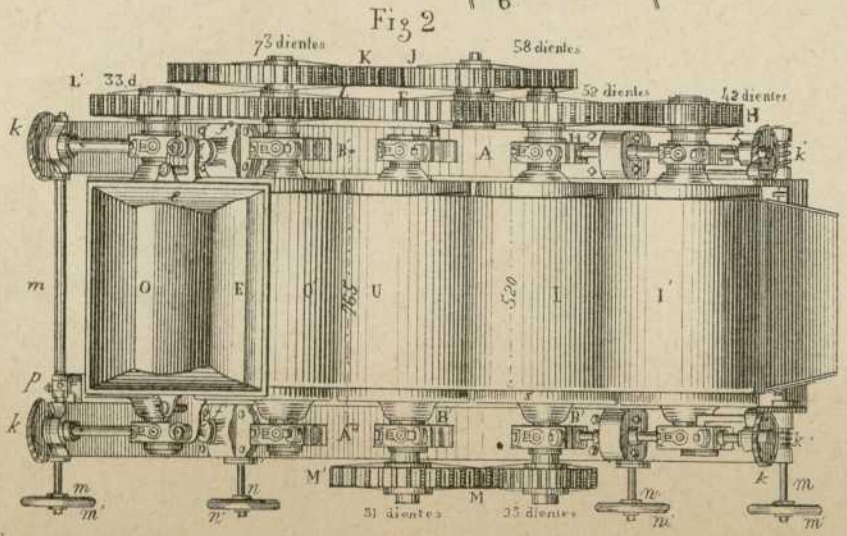
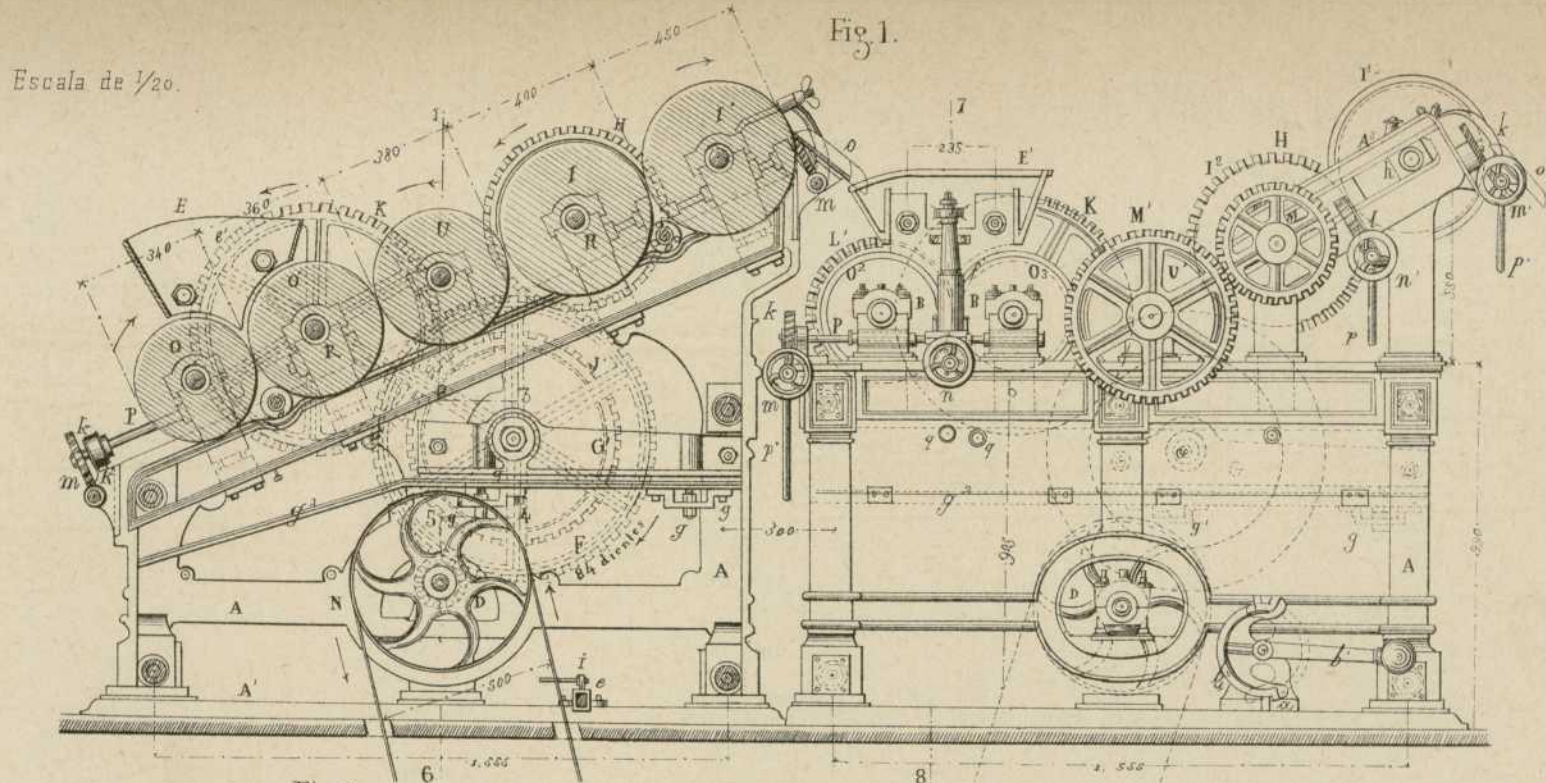
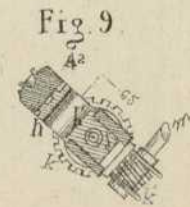
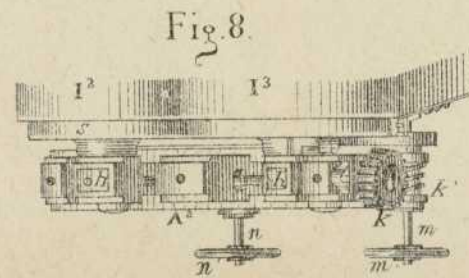
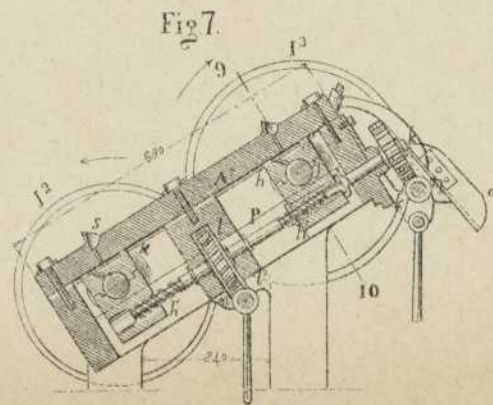
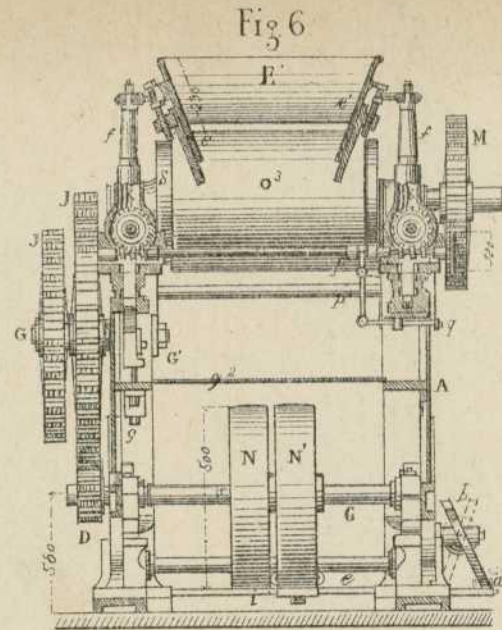
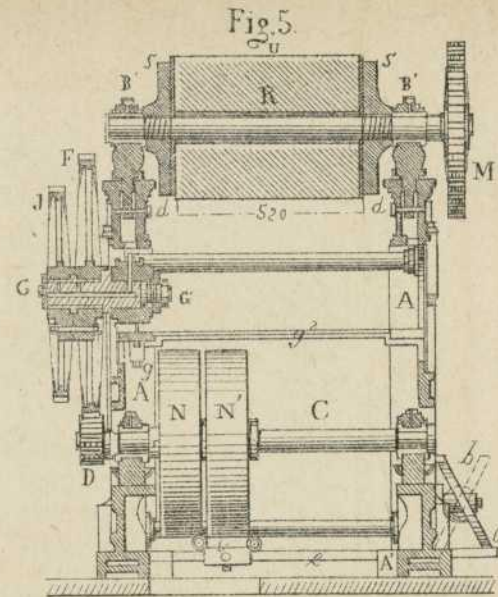
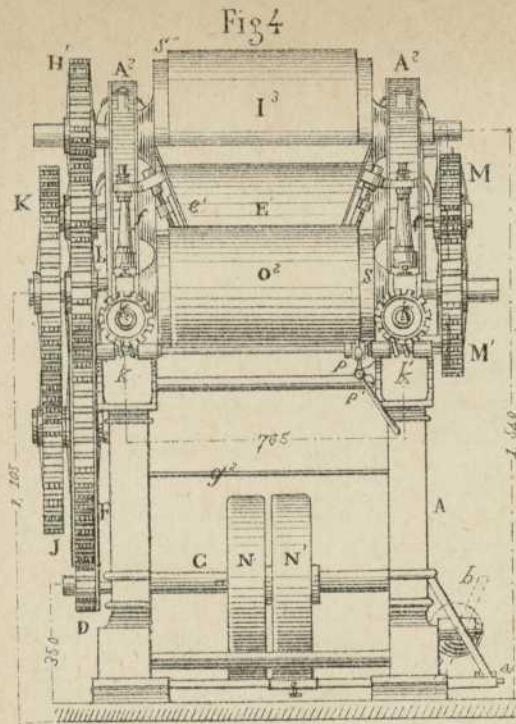


Fig. 6



Escala de 1/100 por las Fig. 2 à 5





Escala de 1/4

Fig. 1.

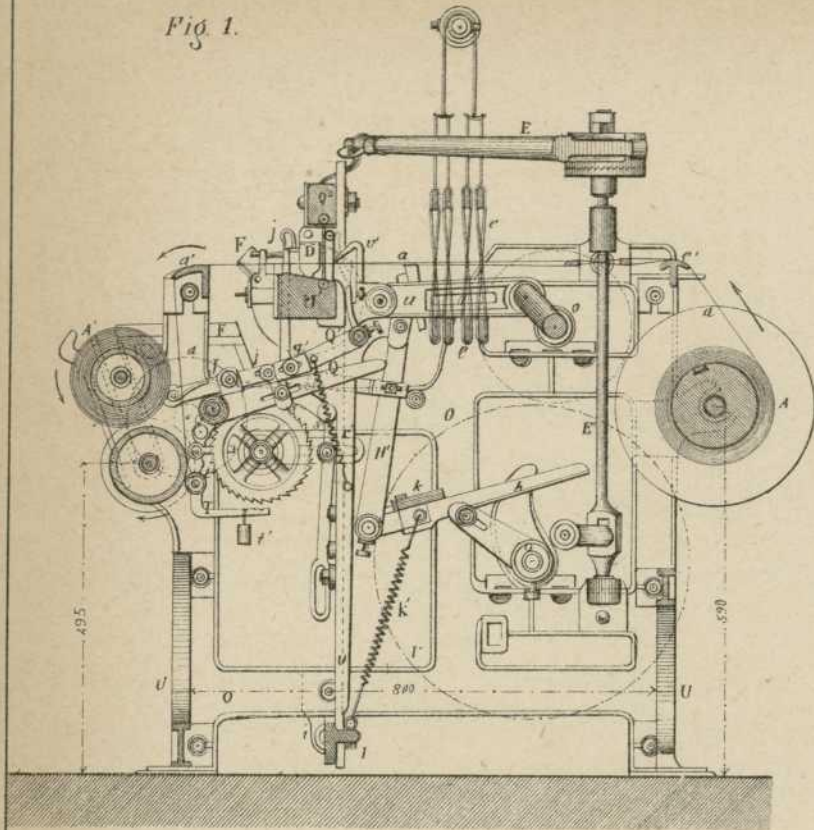


Fig. 11.

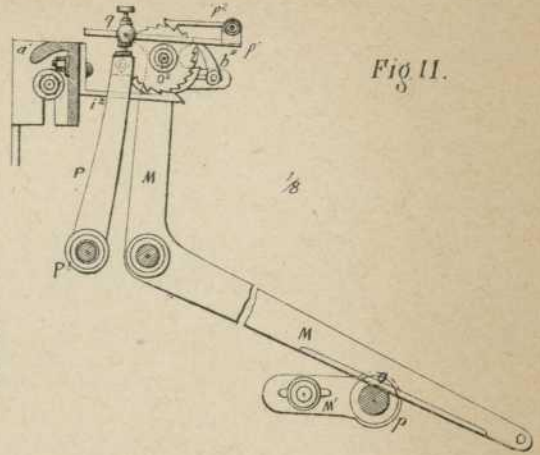


Fig. 5.

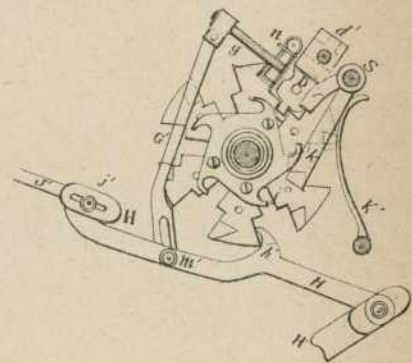


Fig. 6.

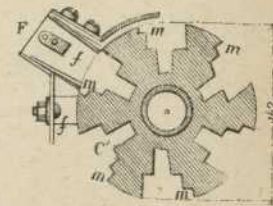


Fig. 4.

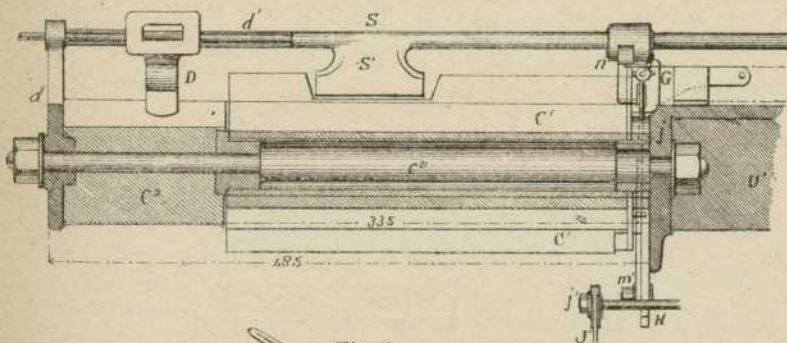


Fig. 9.



Fig. 10.

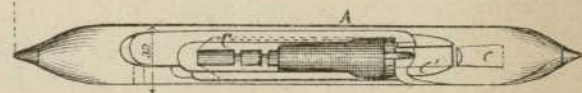
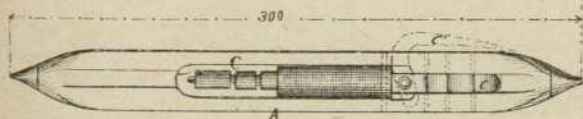


Fig. 8.

Escala de 1/4



Escala de 1/2 por las Fig. 1 a 3.

Escala de 1/6 por las Fig. 4 a 6.

Fig. 2

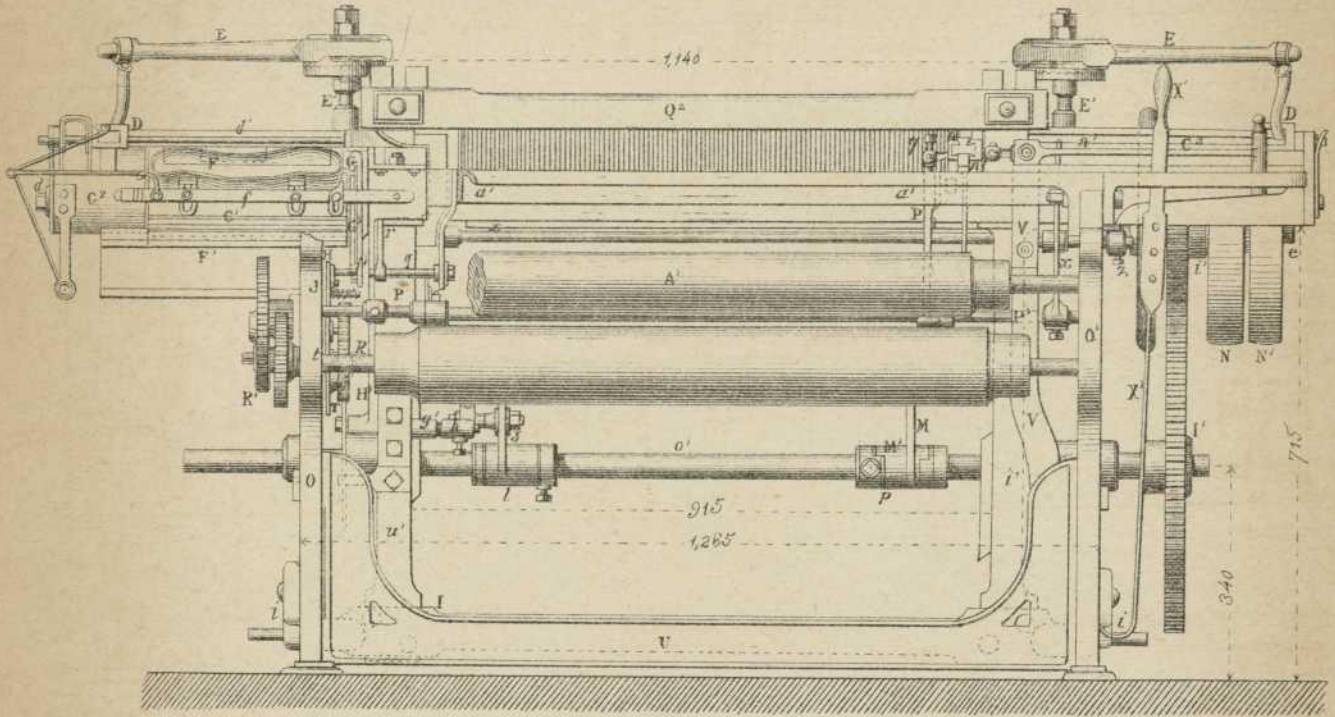
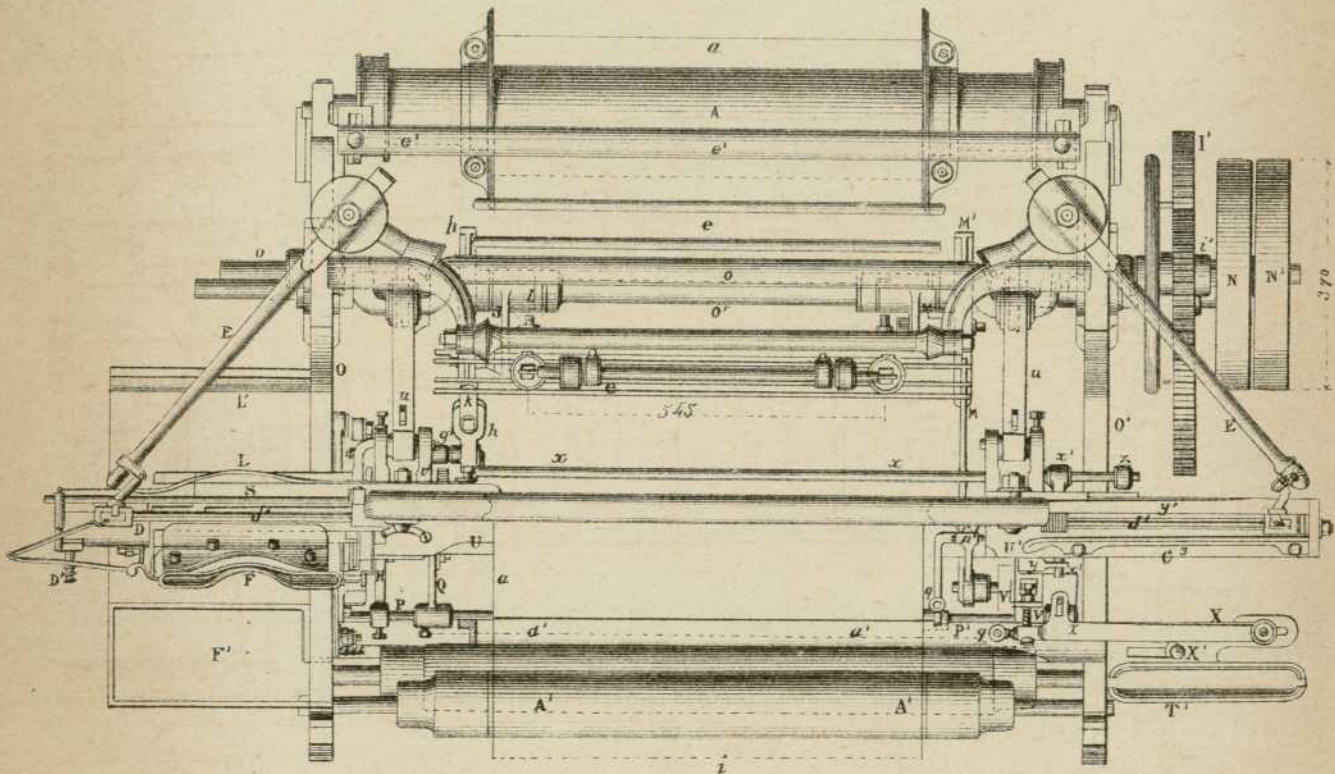
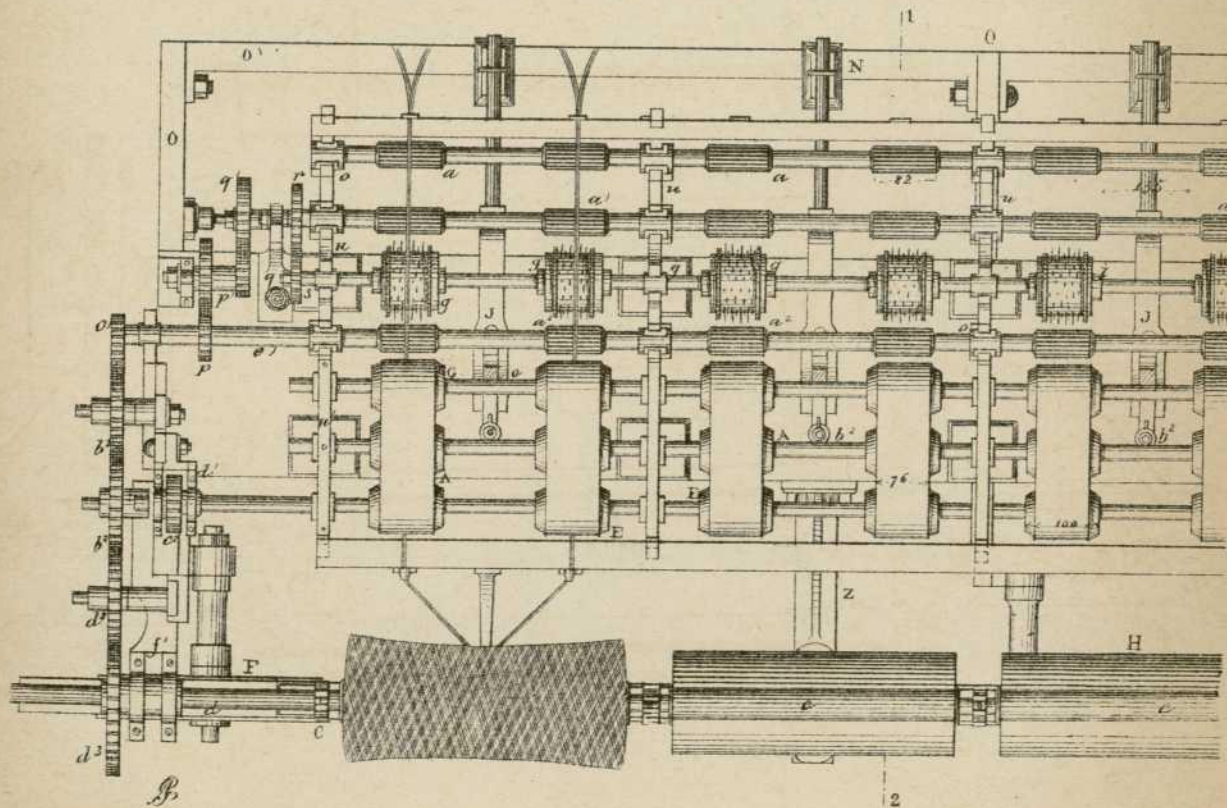
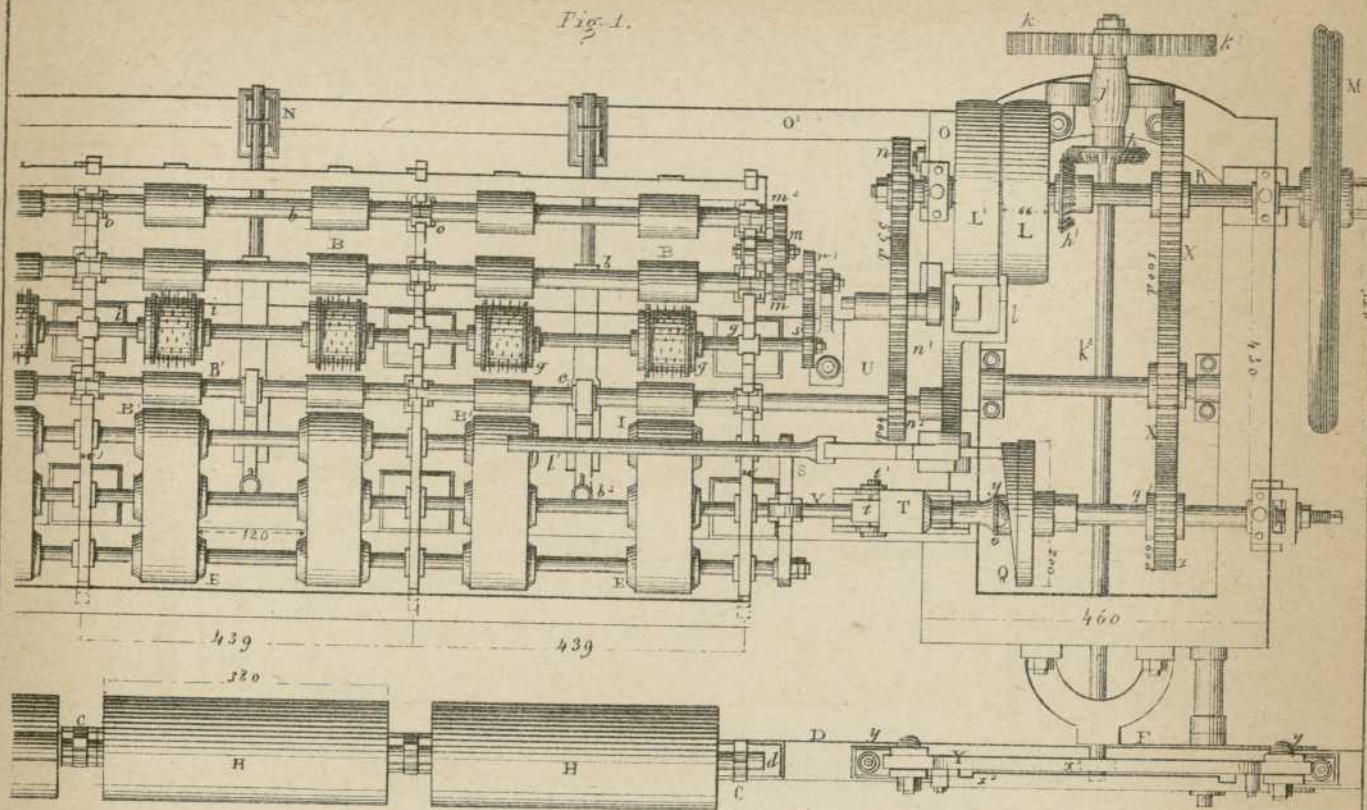
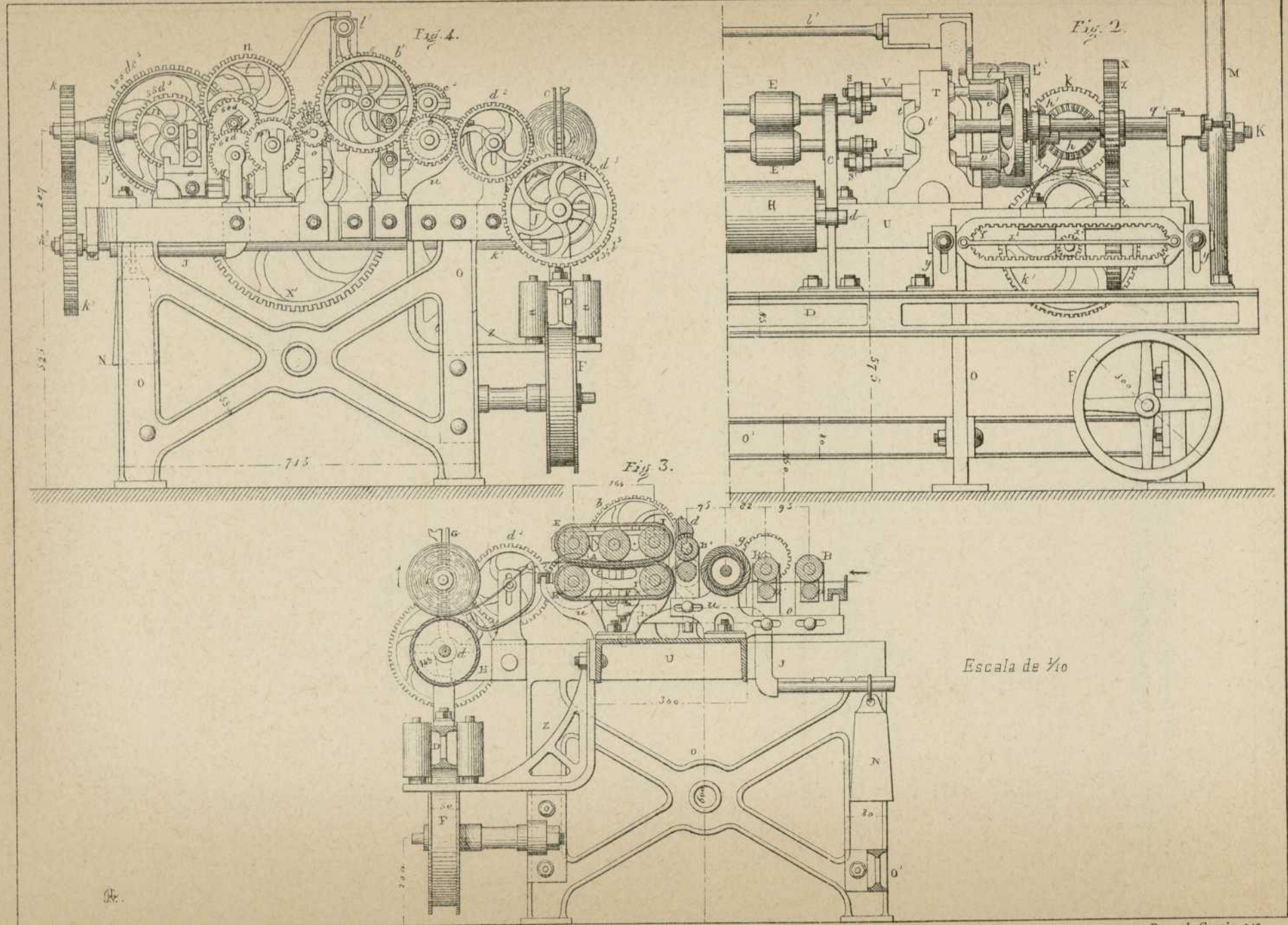


Fig. 3





Continuacion de la Fig. 1.



Dec. 10 9 8 7 6 5 4 3 2 1 0 1 2 Met

Escala de 1/25.

Fig. 3.

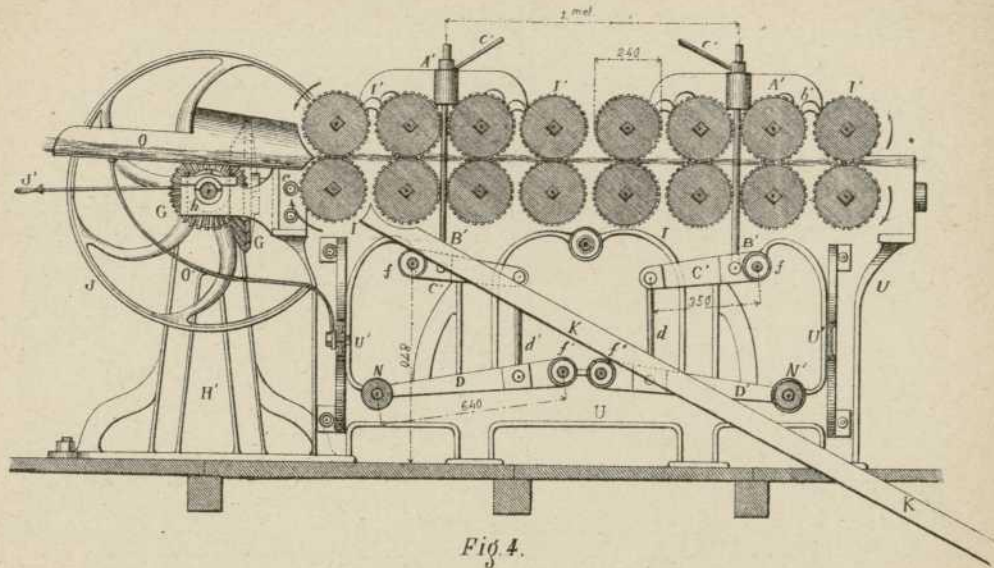


Fig. 4.

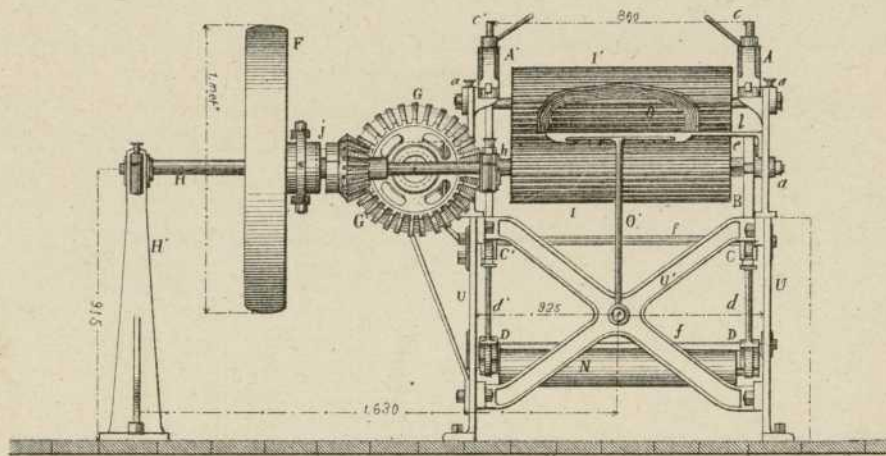


Fig. 1.

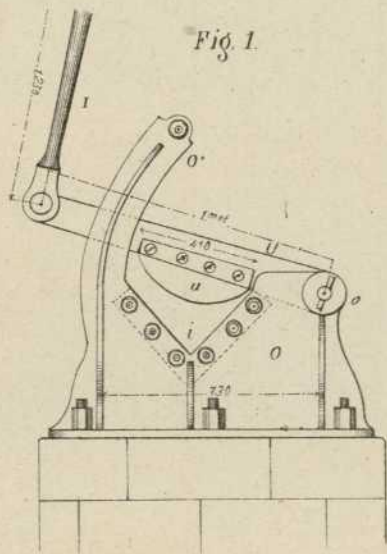


Fig. 2.

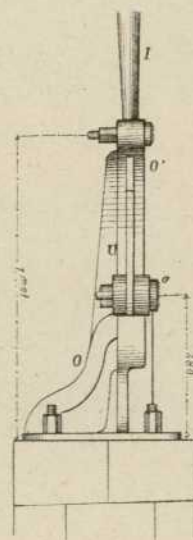
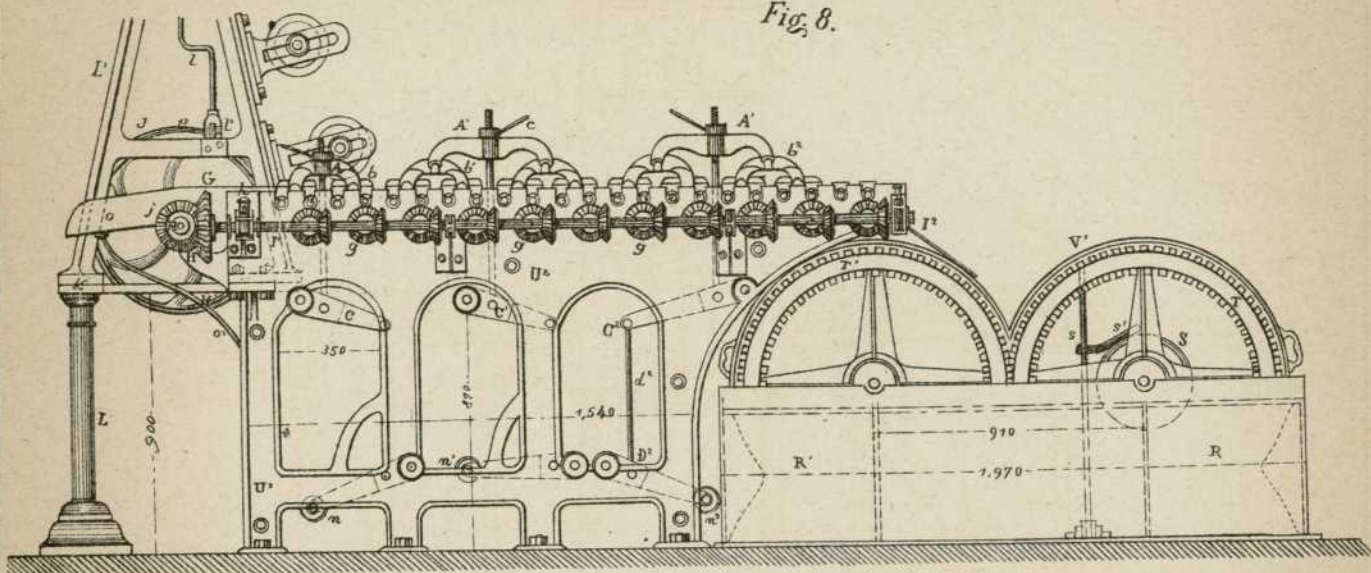


Fig. 8.



Escala de 1/25 por las Fig. 5. à 8.

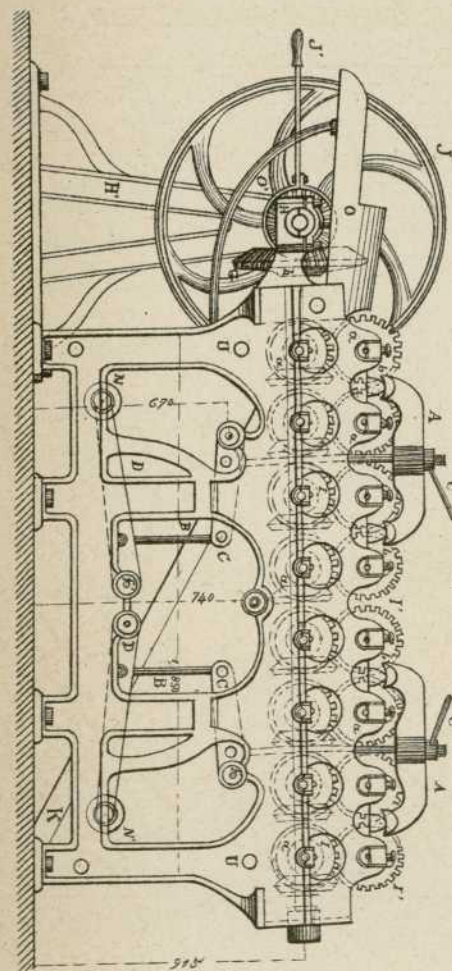


Fig. 5.

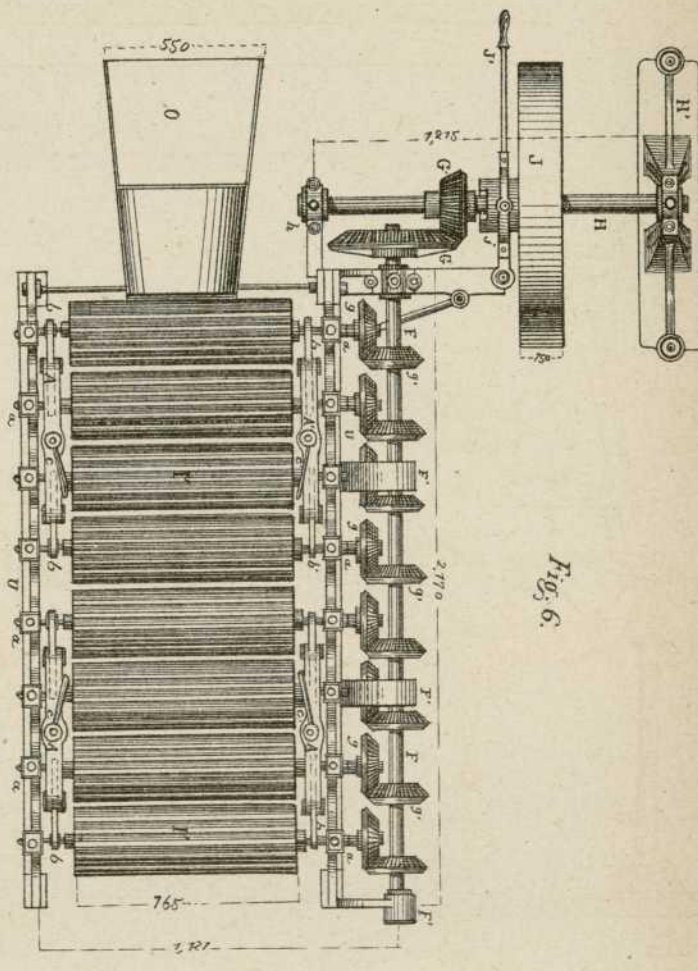
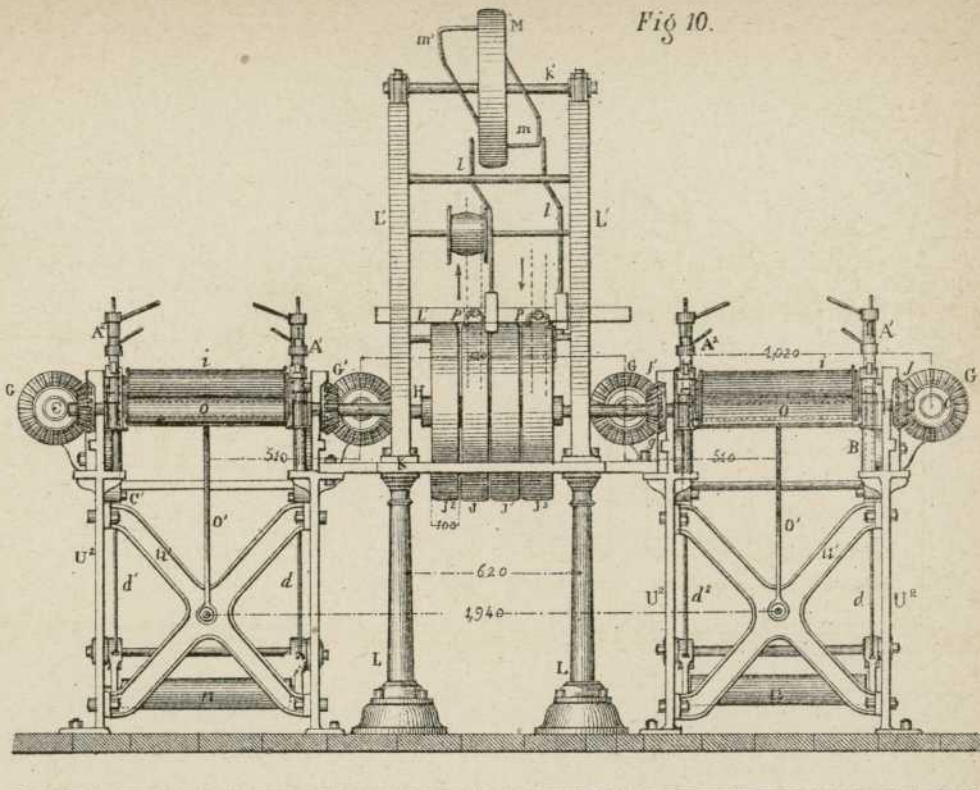


Fig. 6.

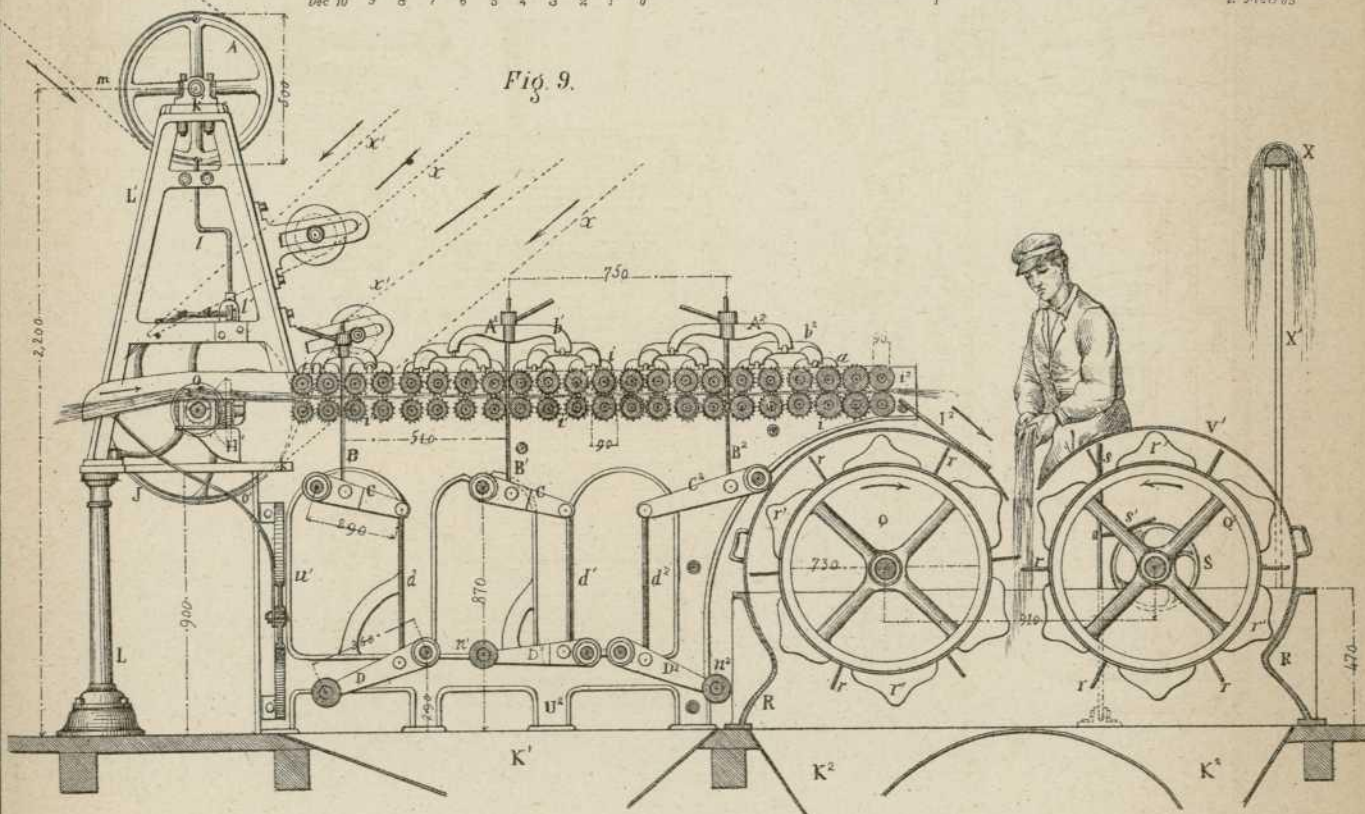
Fig 10.



Escala de 1/25

Déc 10 9 8 7 6 5 4 3 2 1 0 | 2 Métras

Fig 9.



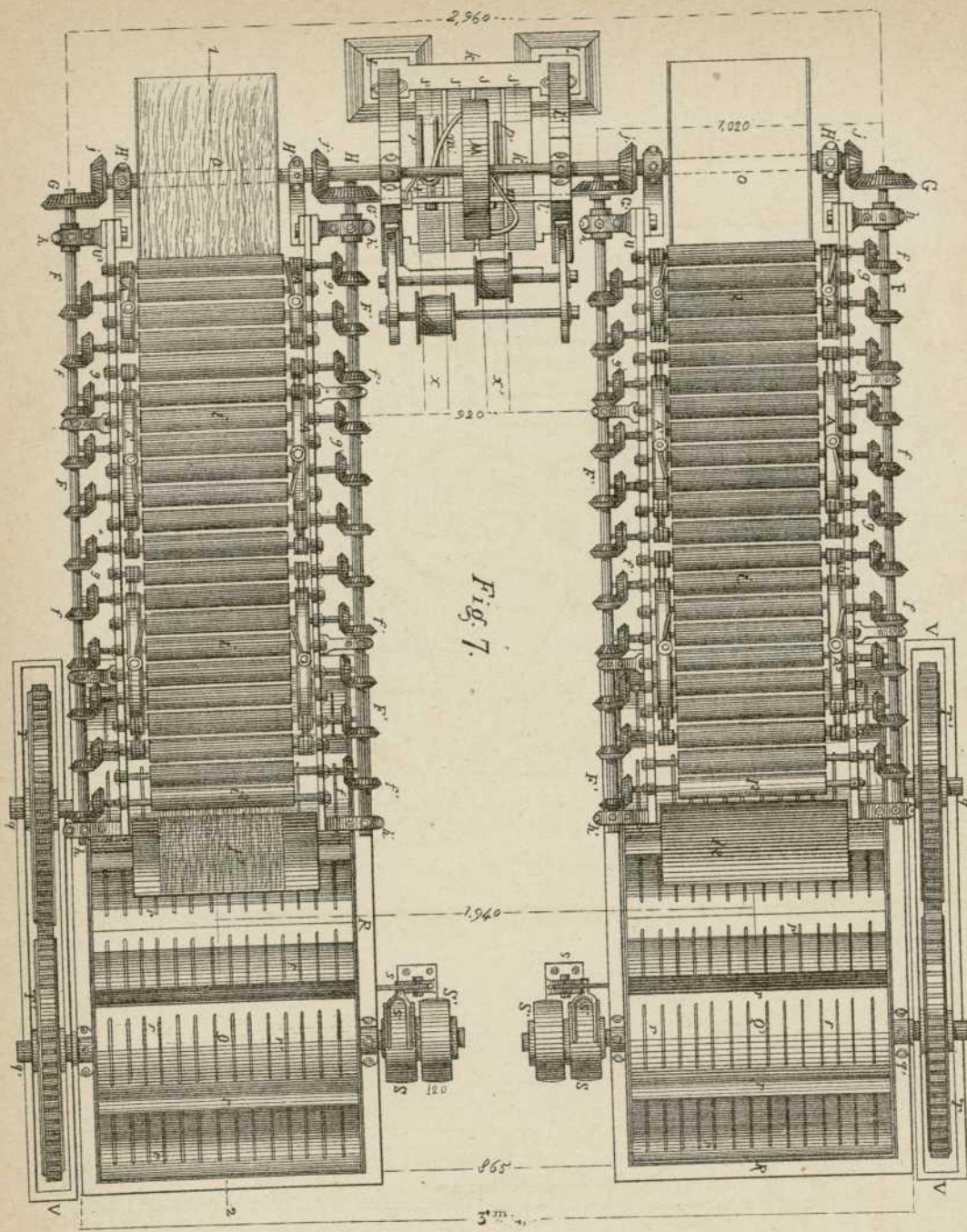


Fig. 7.

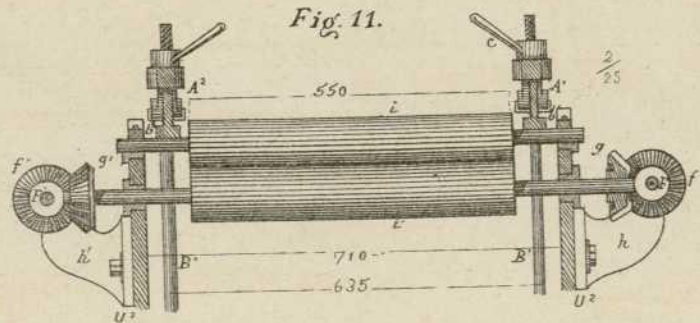


Fig. 11.

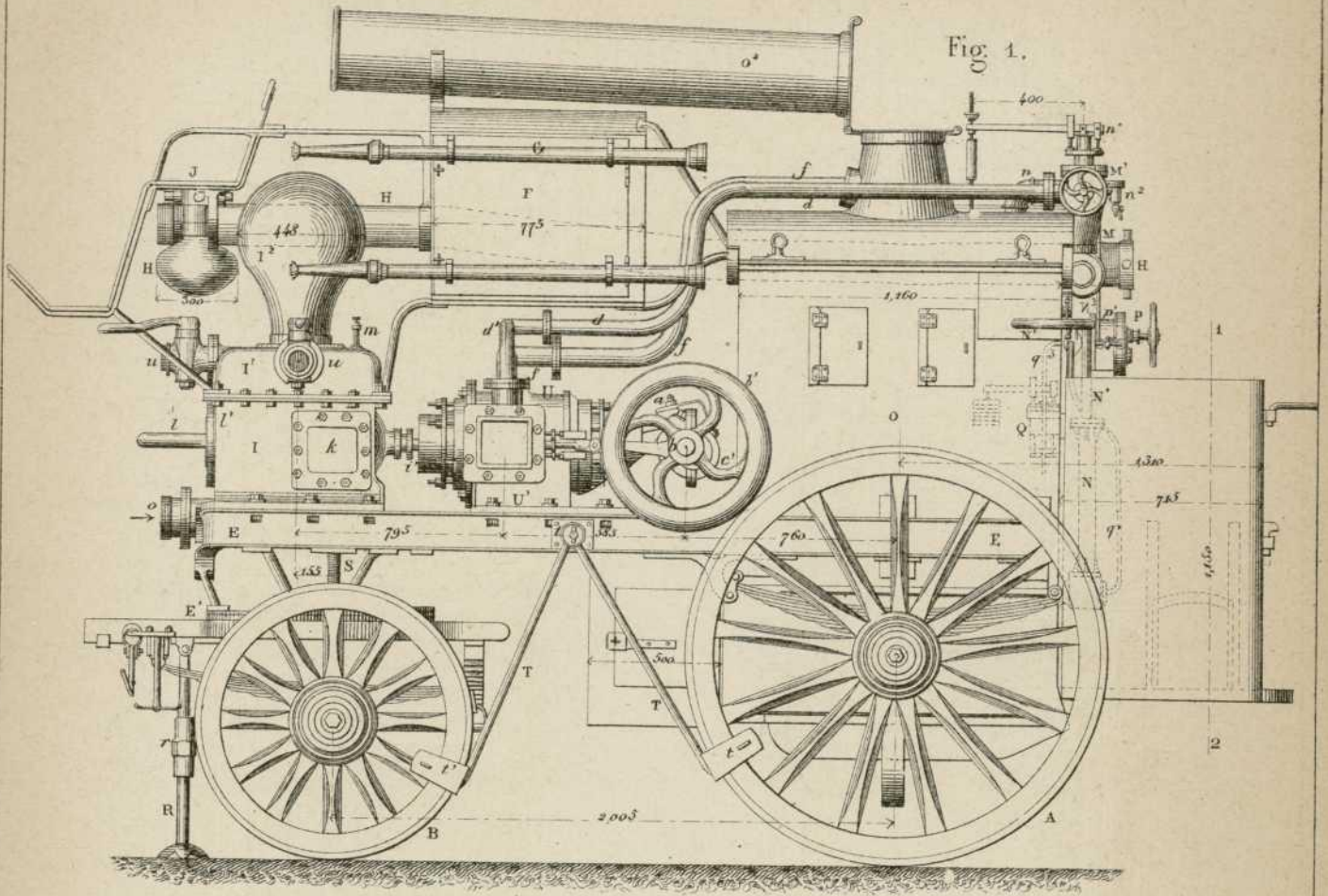


Fig. 1.

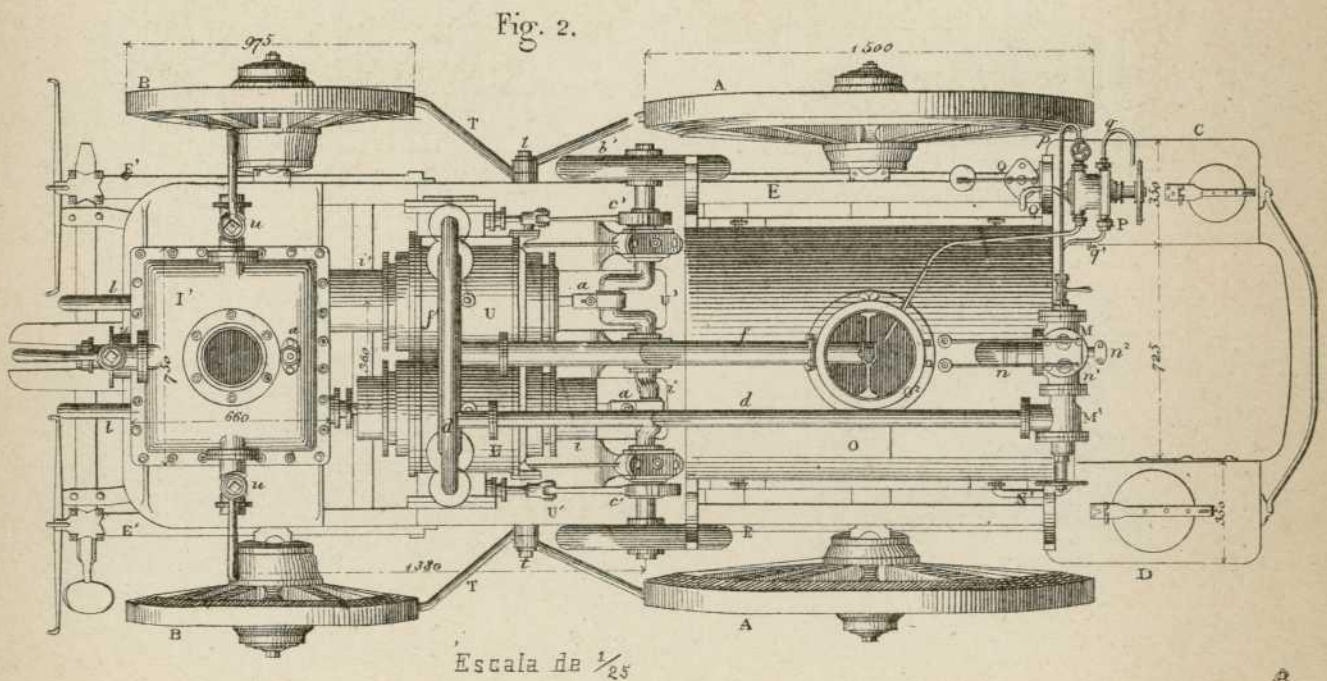


Fig. 2.

Escala de $\frac{1}{25}$

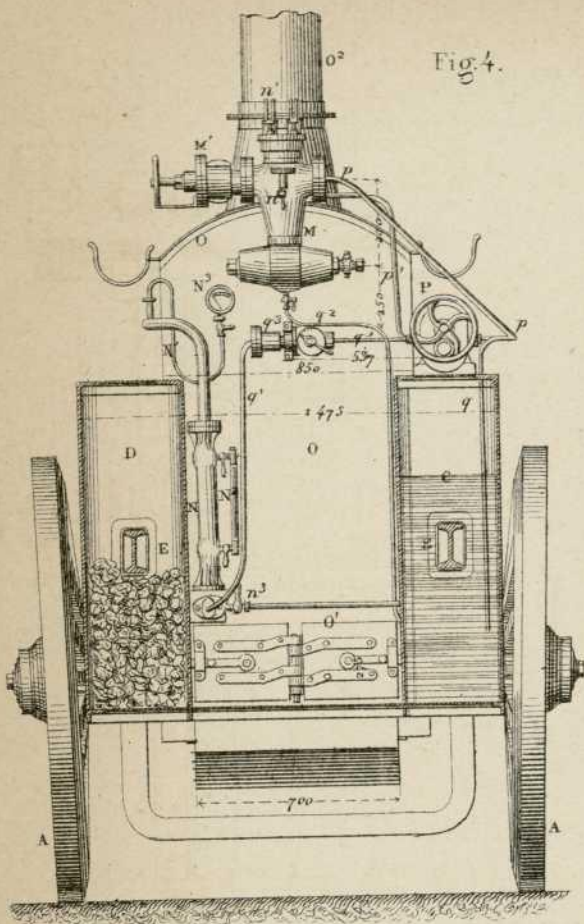


Fig. 4.

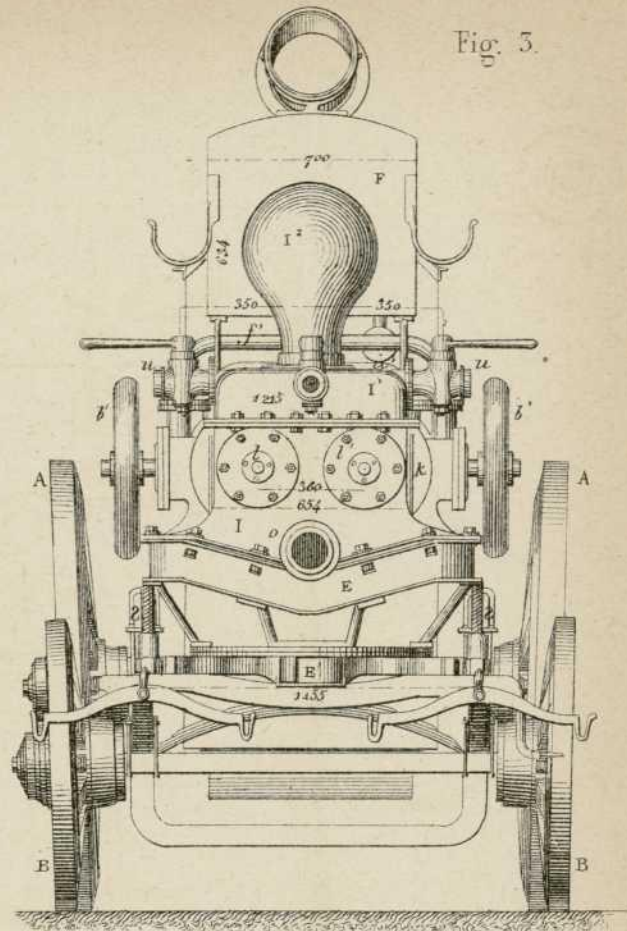


Fig. 5.

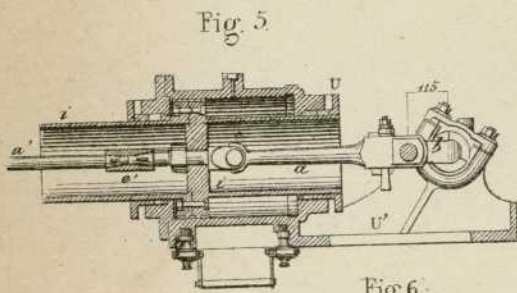


Fig. 5.

Fig. 6.

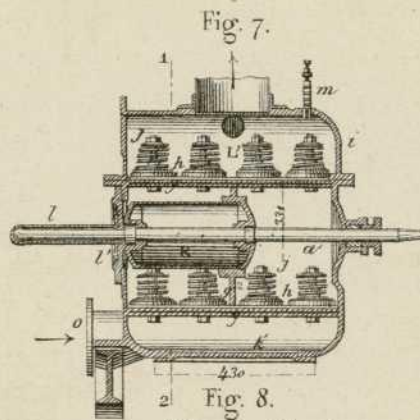
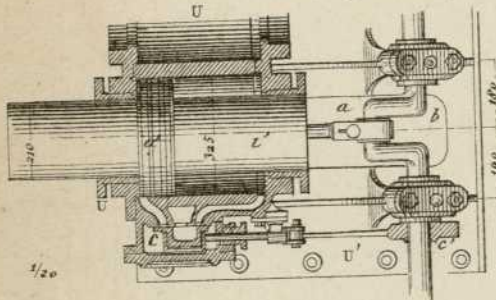


Fig. 7.

Fig. 8.

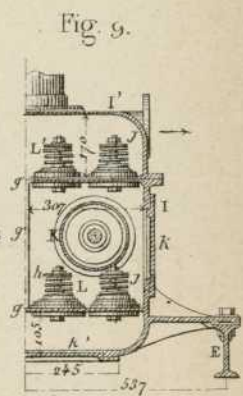
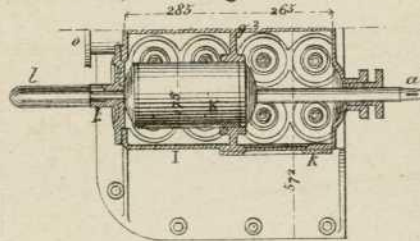


Fig. 9.

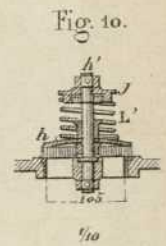


Fig. 10.

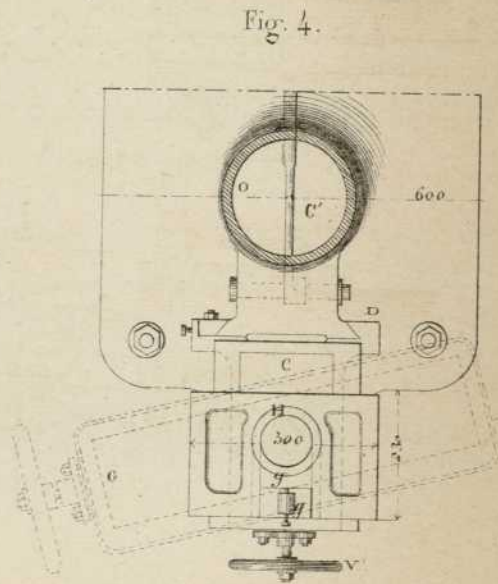
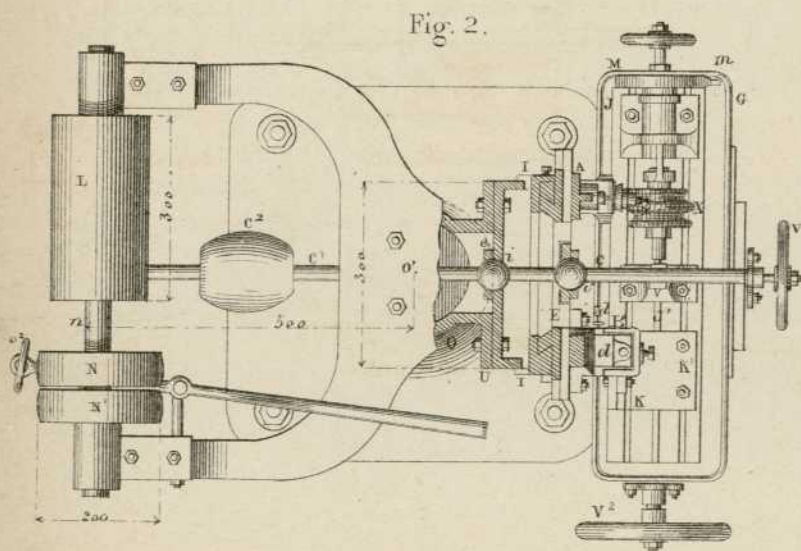
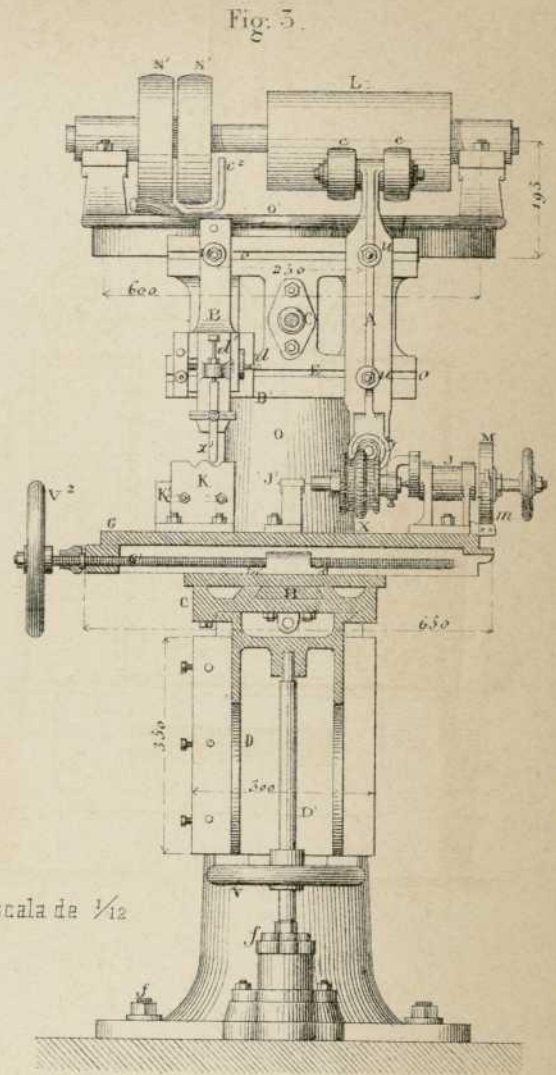
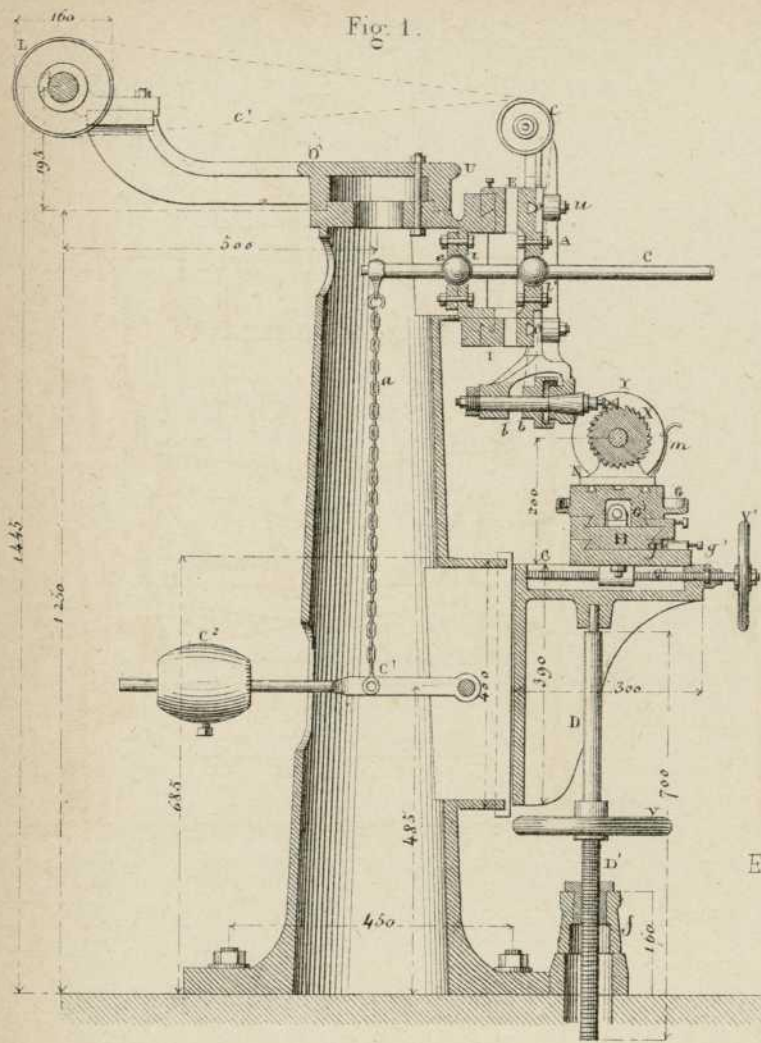


Fig. 5.

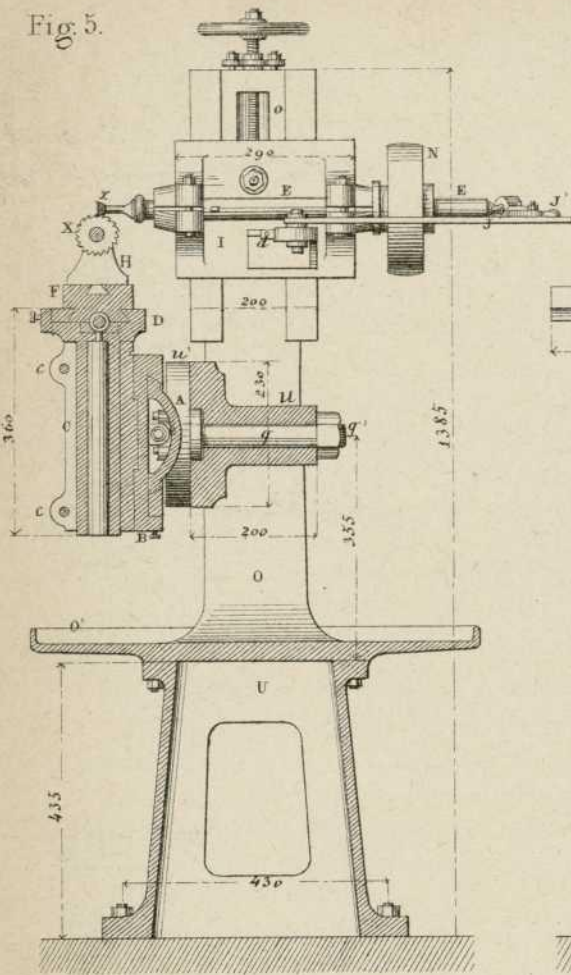


Fig. 6.

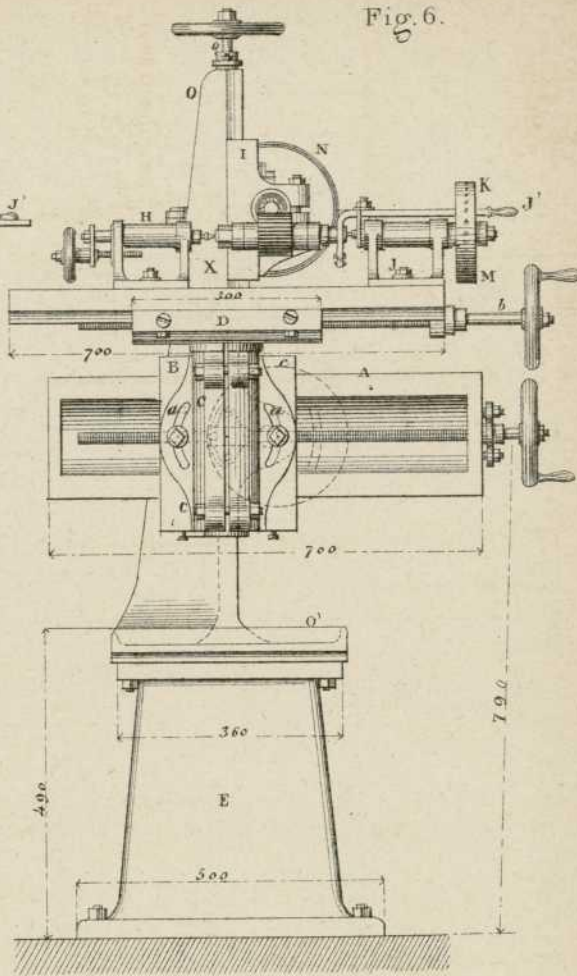


Fig. 7.

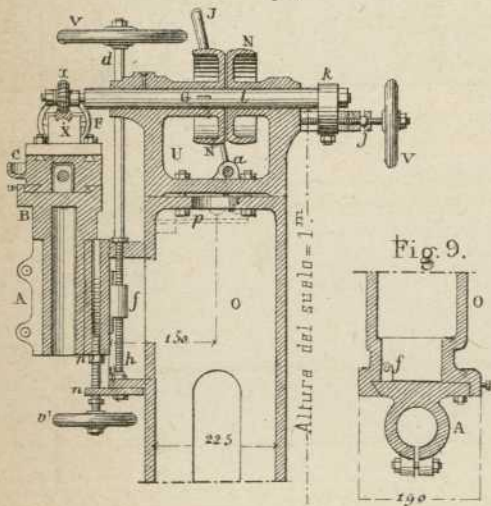


Fig. 8.

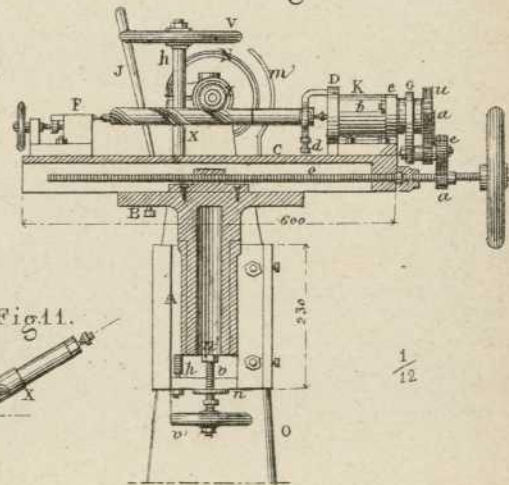


Fig. 10.



Fig. 9.

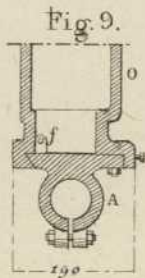
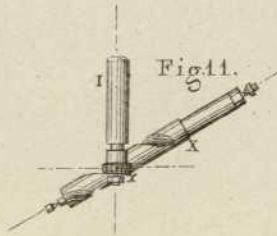


Fig. 11.



8

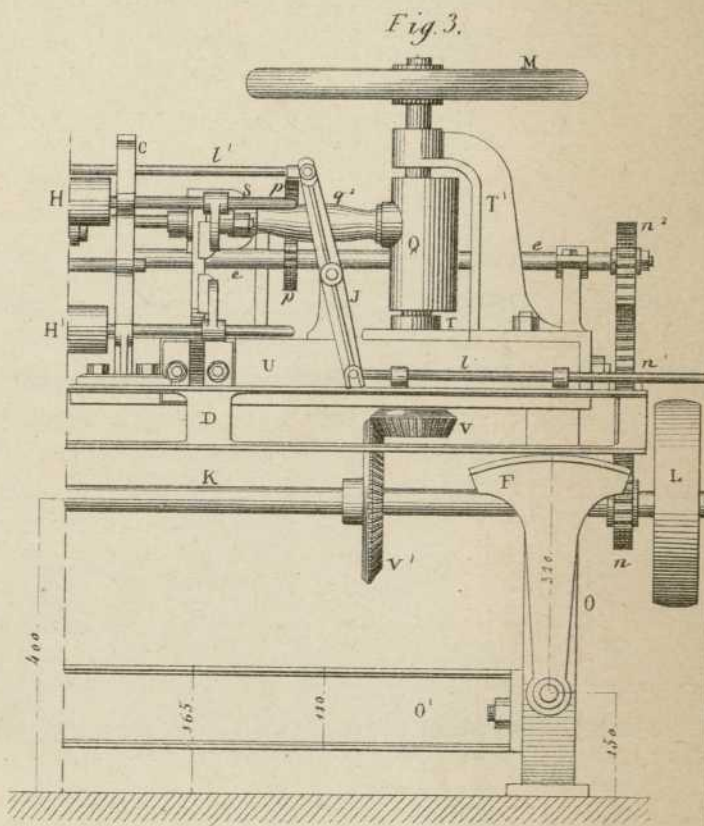
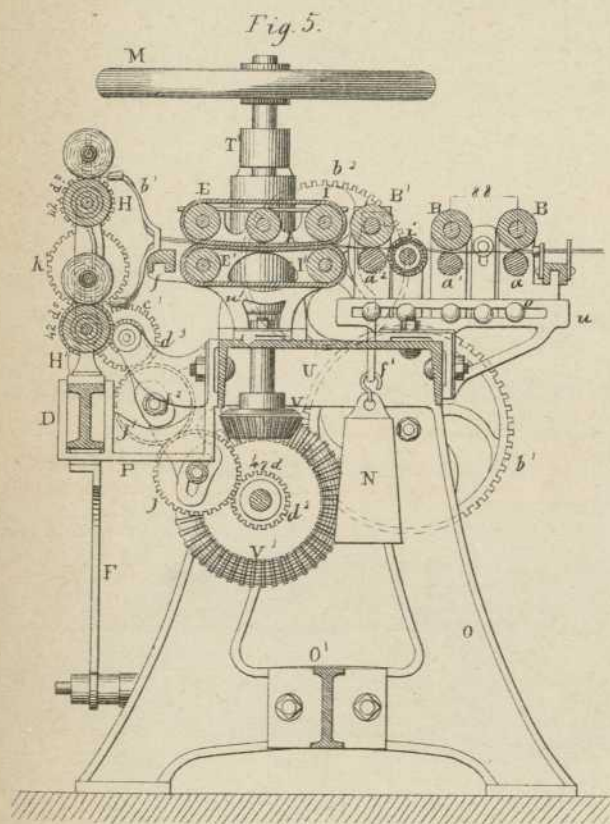
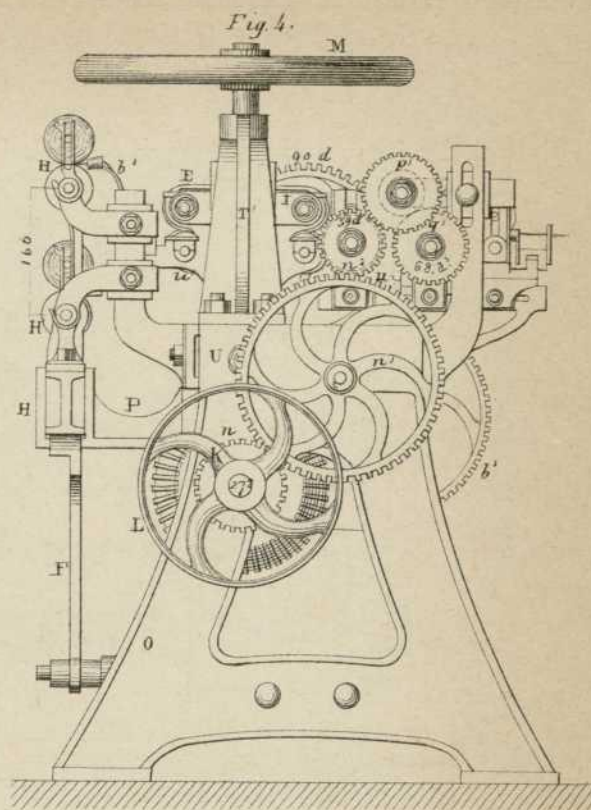
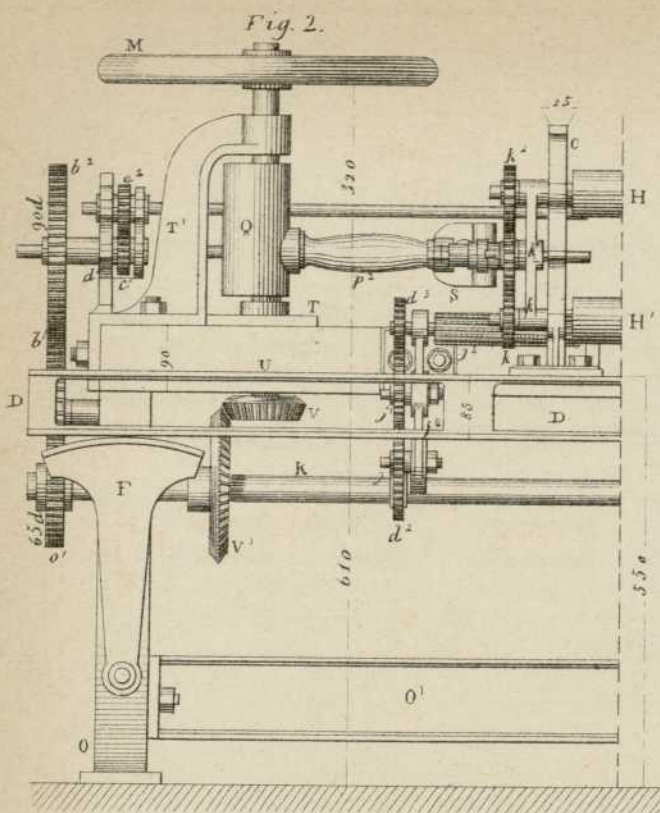
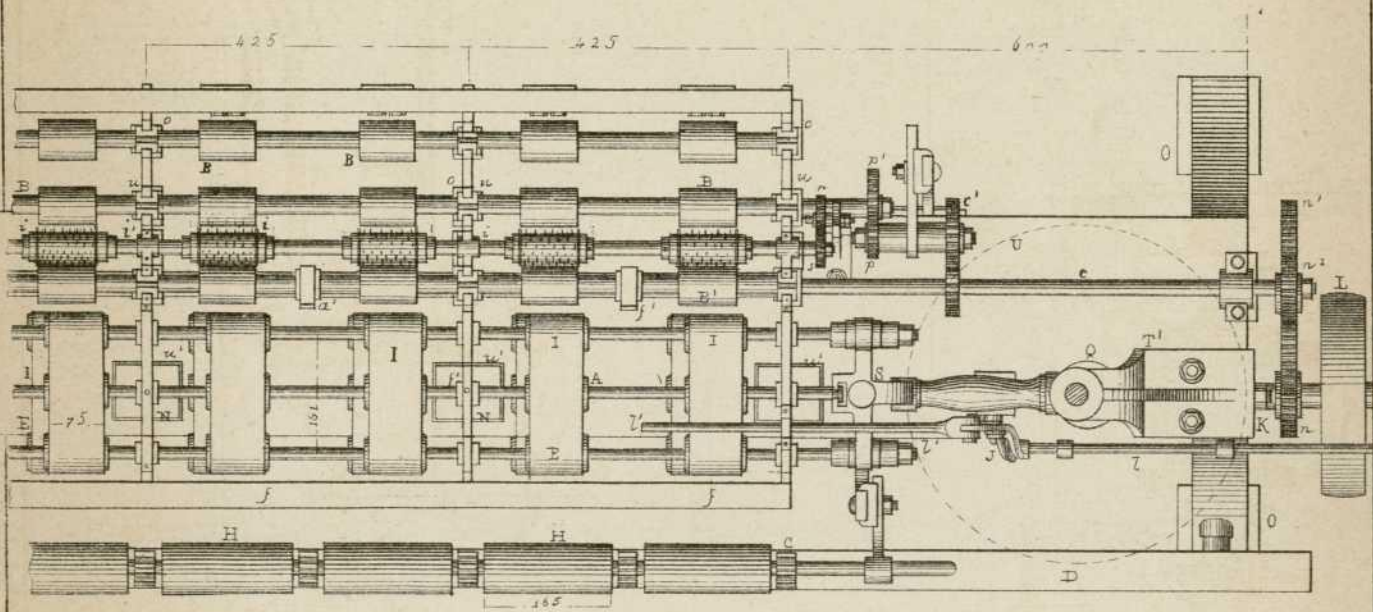
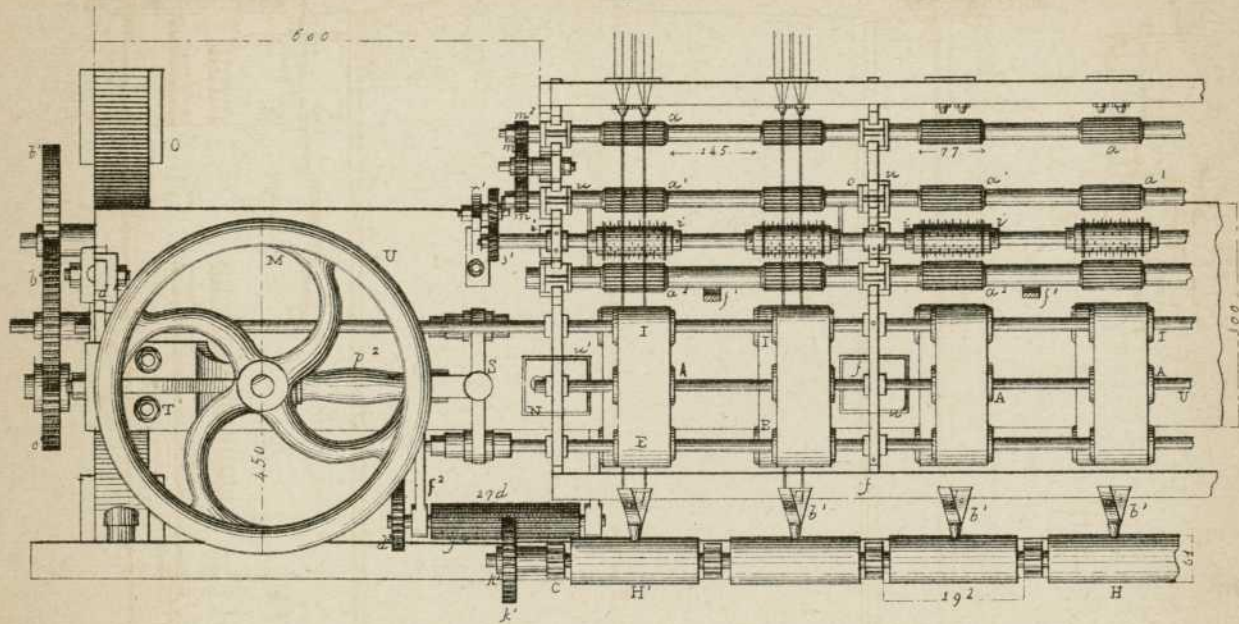
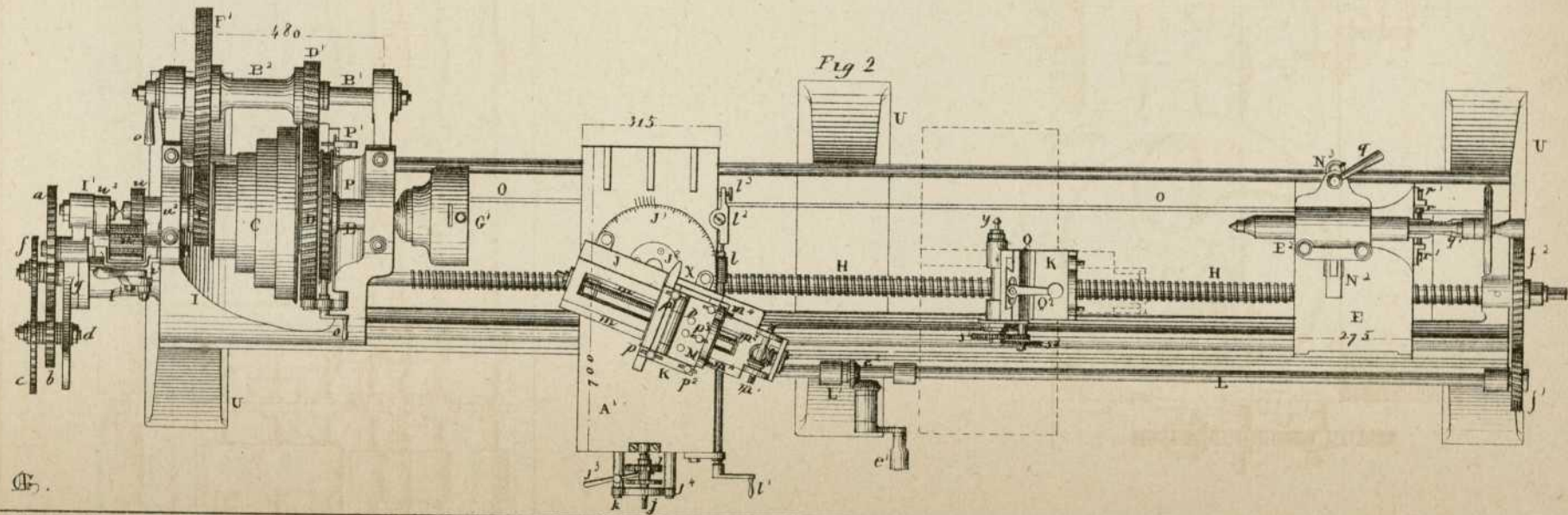
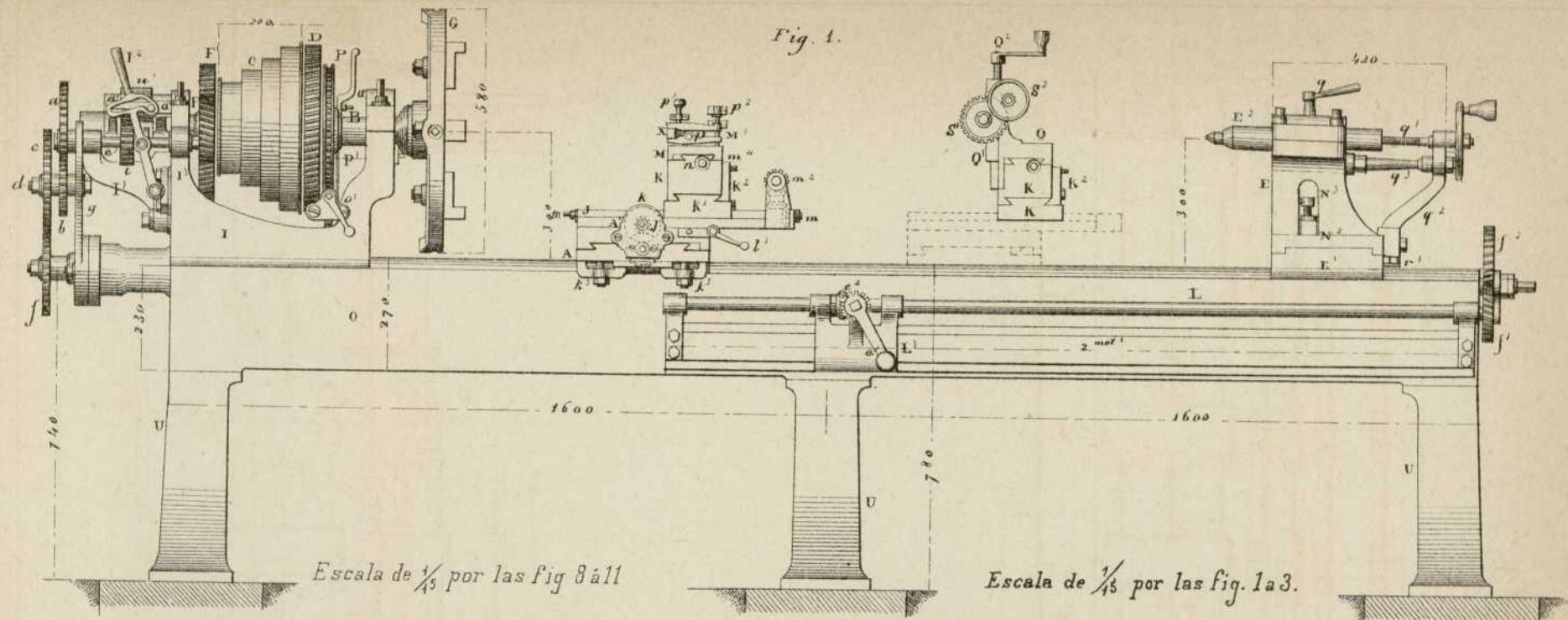


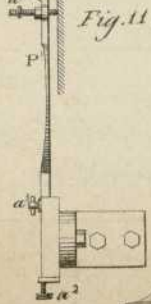
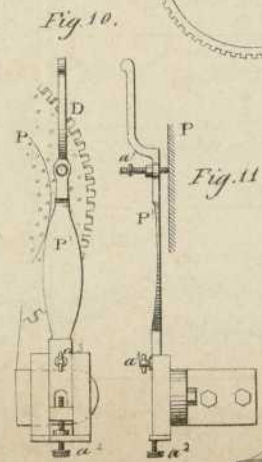
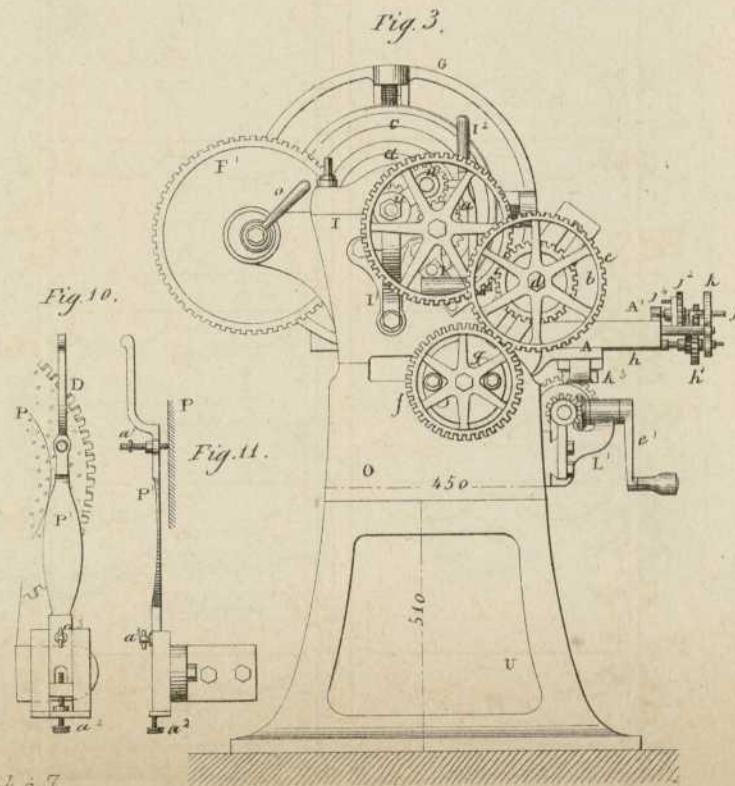
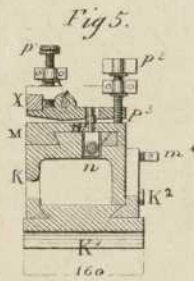
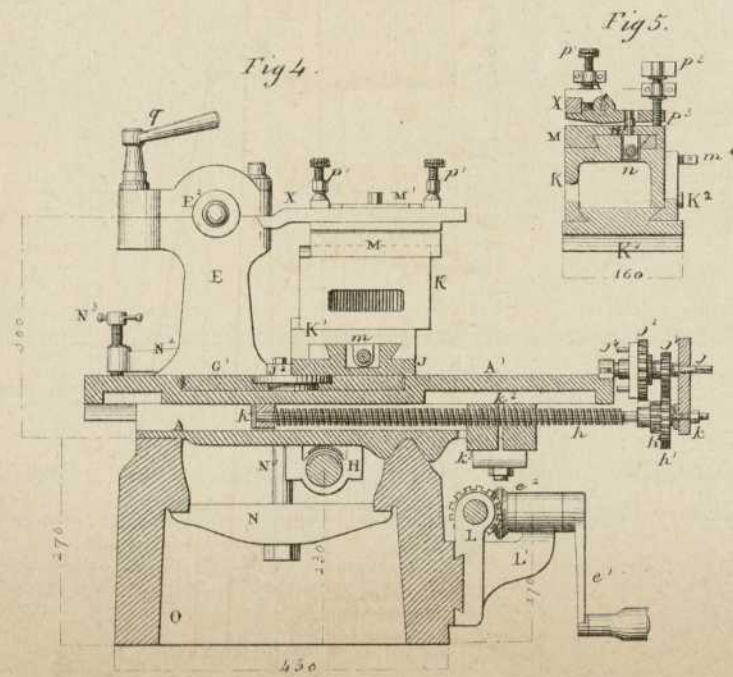
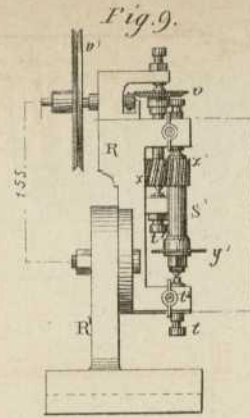
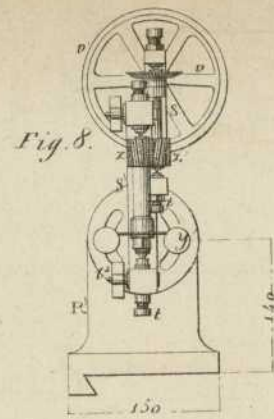
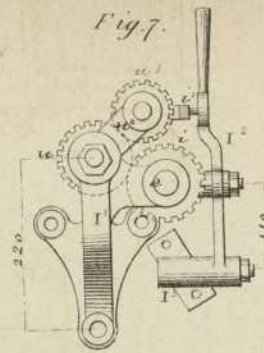
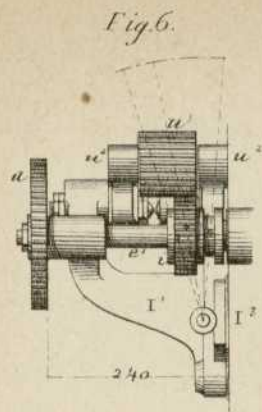
Fig. 1



Continuacion de la fig. 1.

Escala de 1/40





6.

Escala de $\frac{1}{10}$ por las fig. 4 à 7.

Fig. 7.

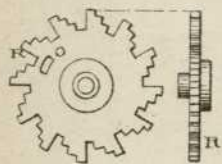


Fig. 3.

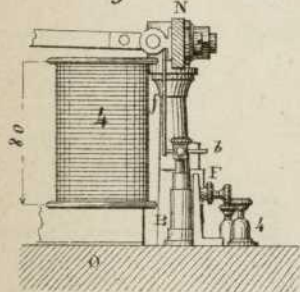


Fig. 1.

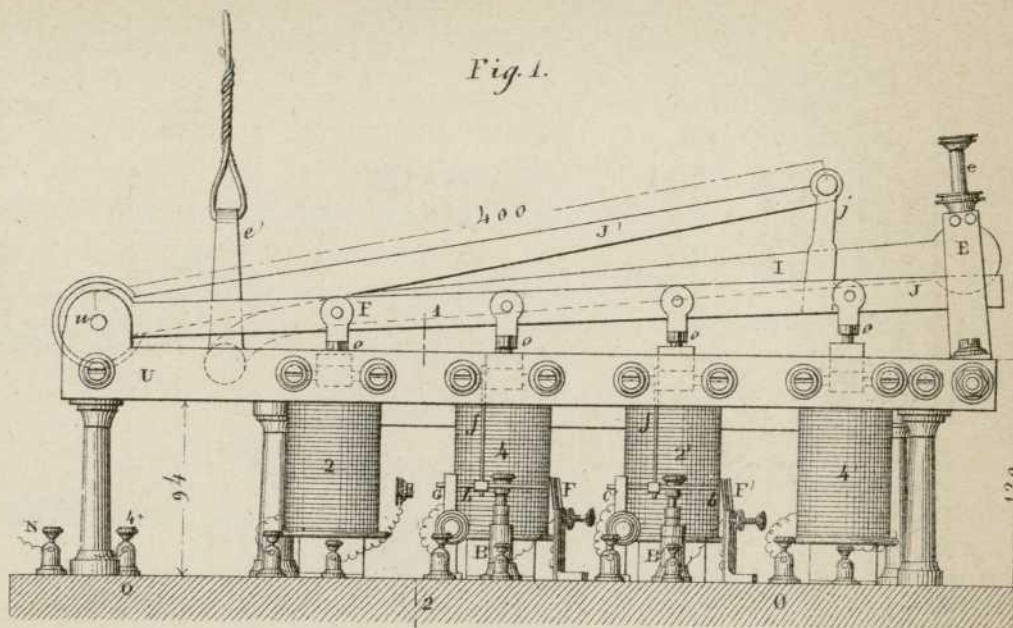


Fig. 2.

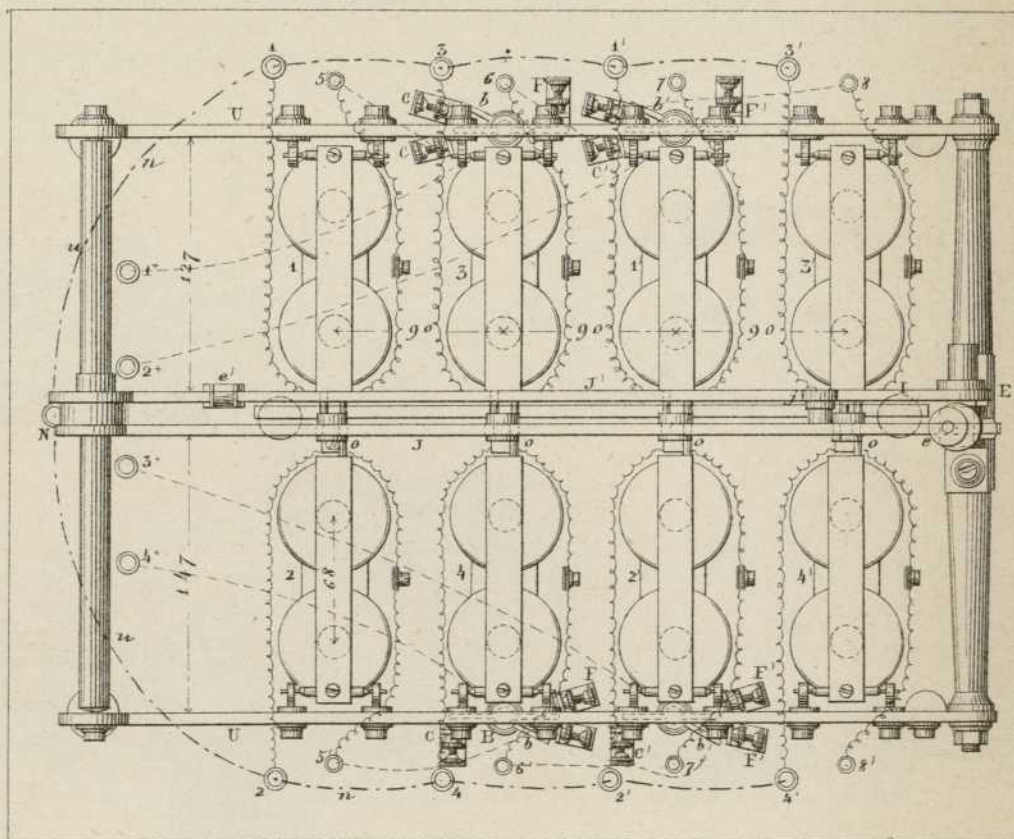
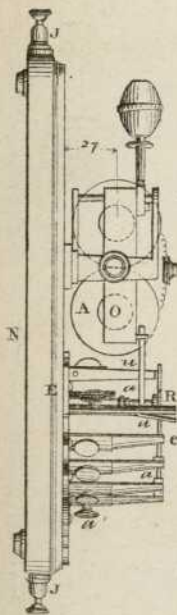


Fig. 10.



Q.

Escala de 1/4 por las fig 1 a 3. 9 y 10

Fig. 5.

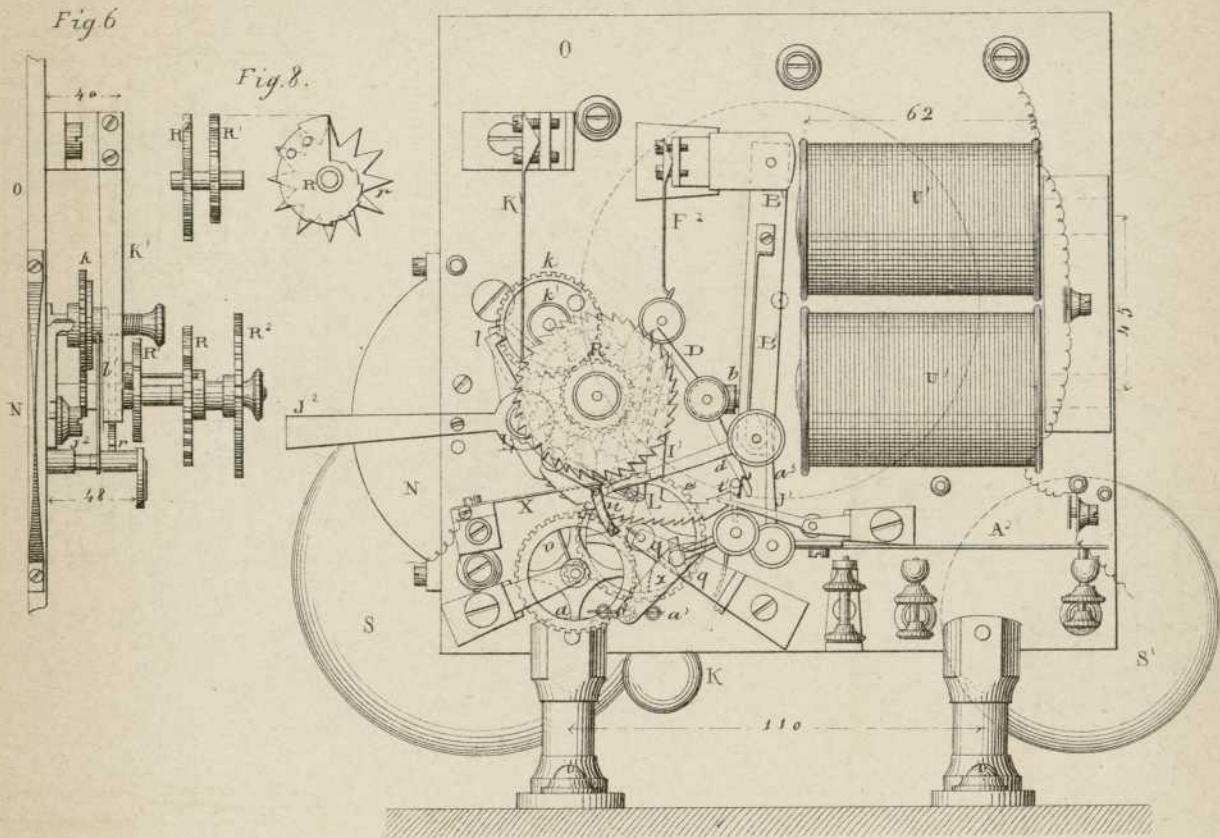


Fig. 6.

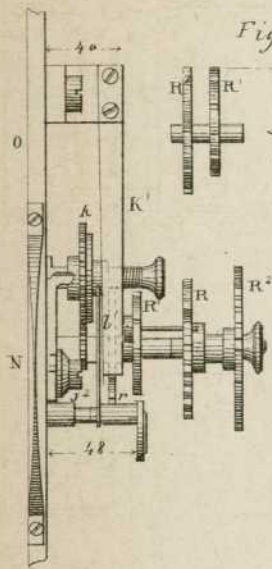


Fig. 8.



Fig. 9.

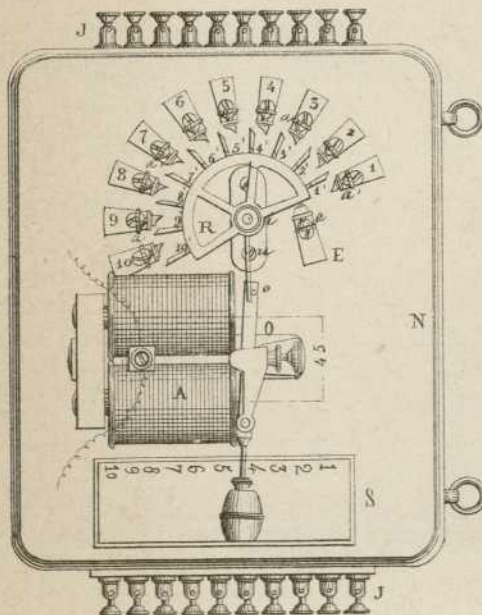
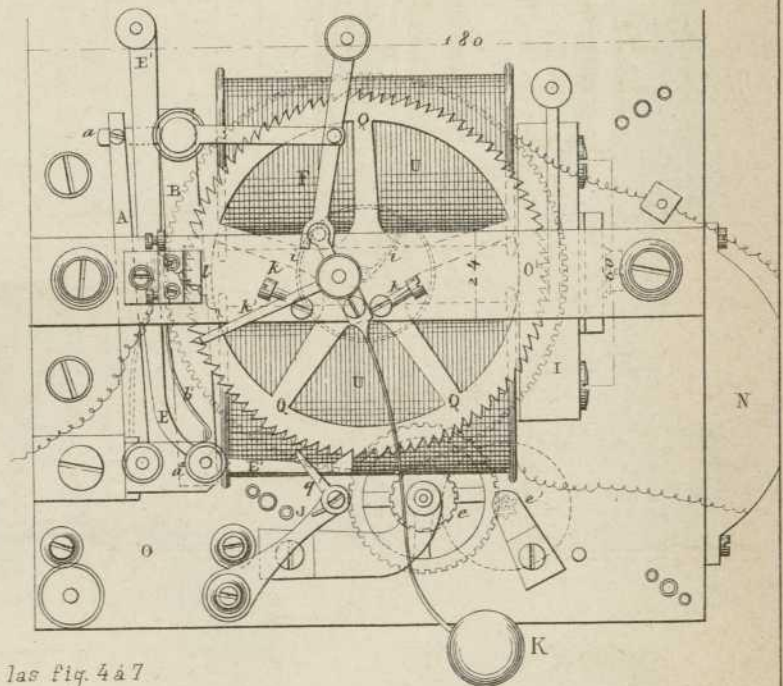


Fig. 4.



Escala de 1/2 por las fig. 4 à 7

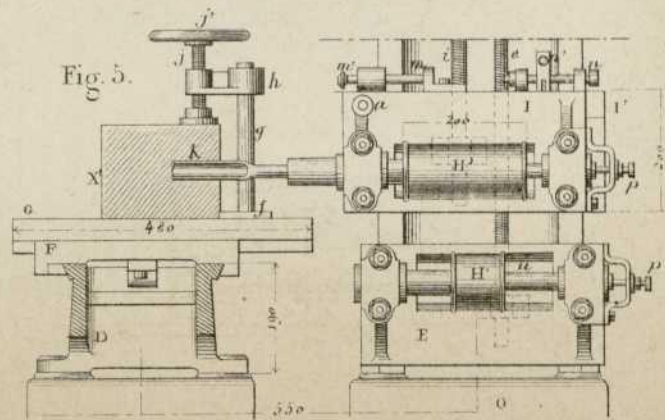
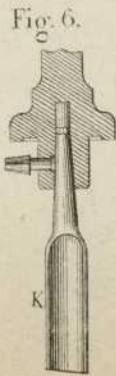
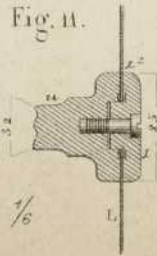
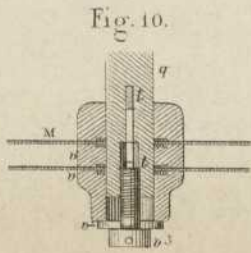
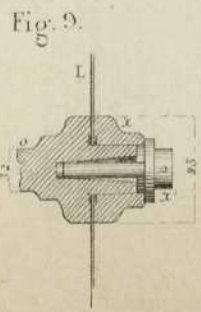
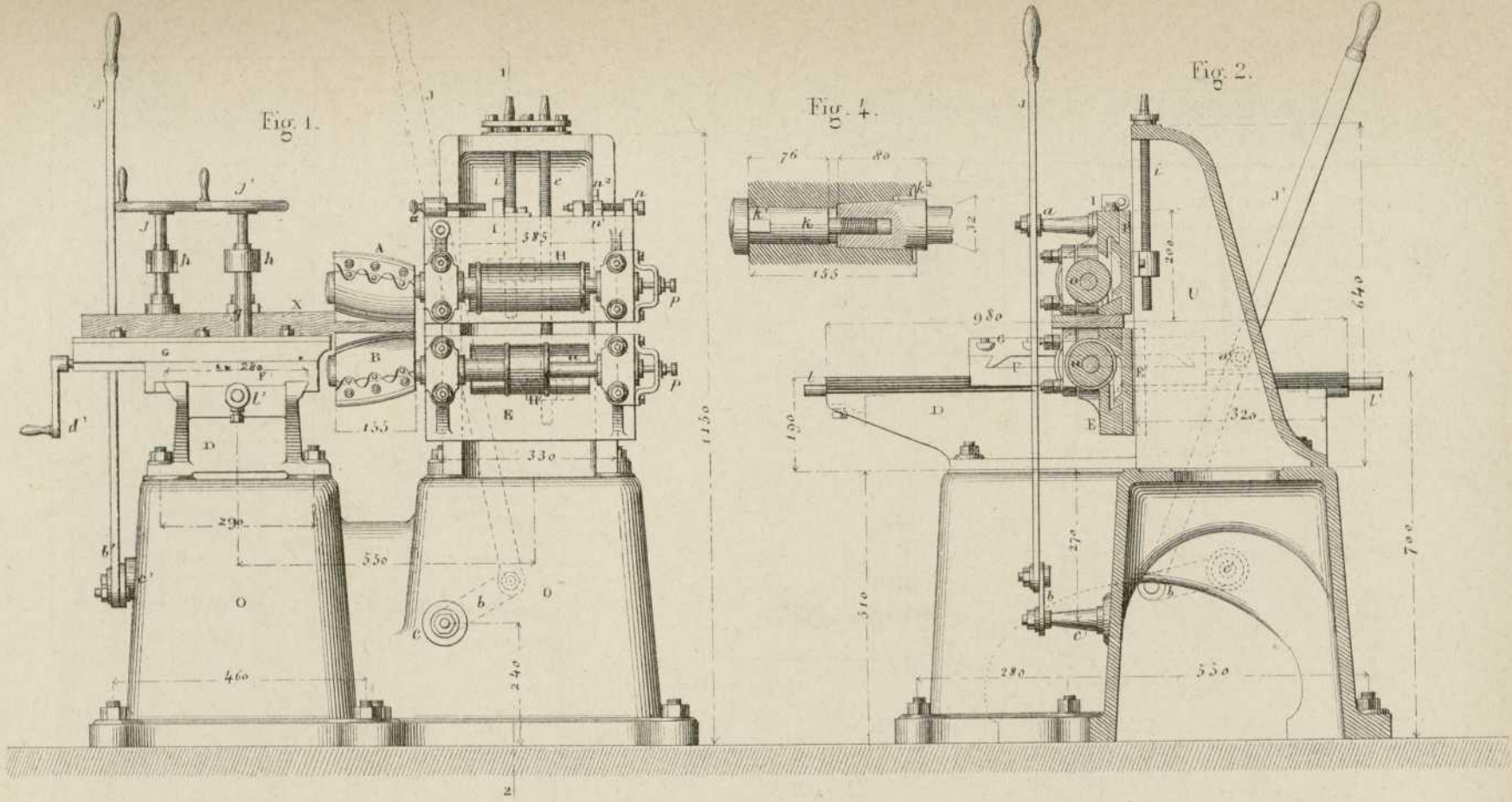


Fig. 5.

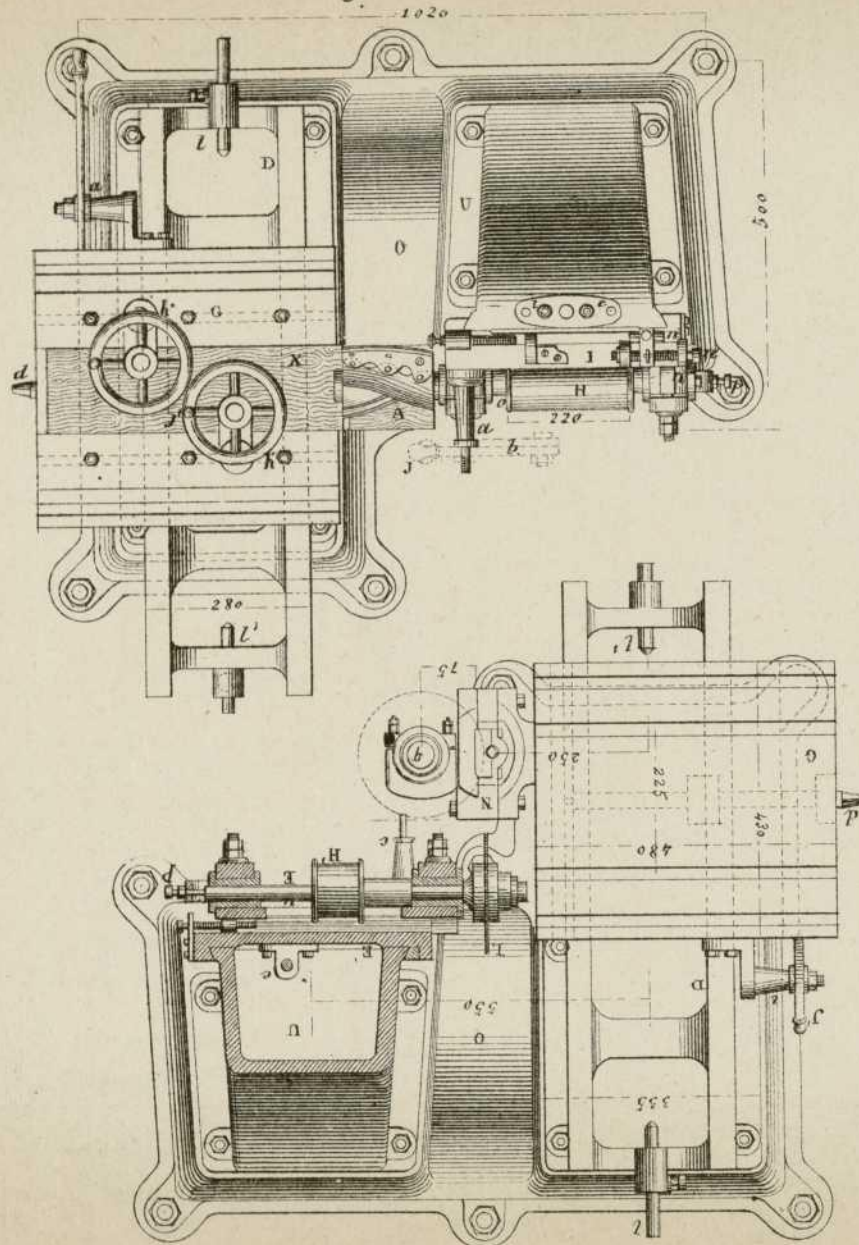
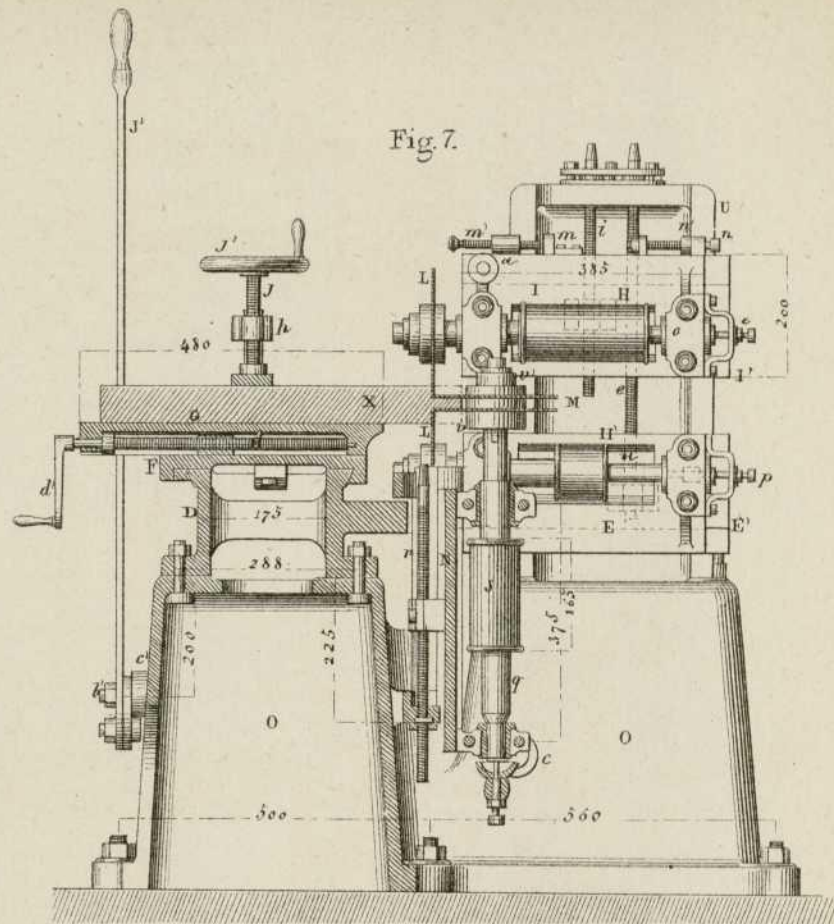


Fig. 8.

Fig. 7.



Escala de $\frac{1}{2}$ por las fig 1á3,5,7y8

Fig. 2

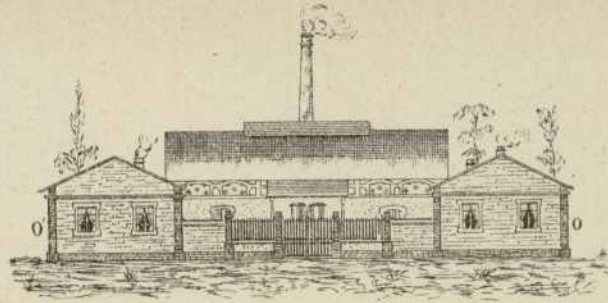


Fig. 3

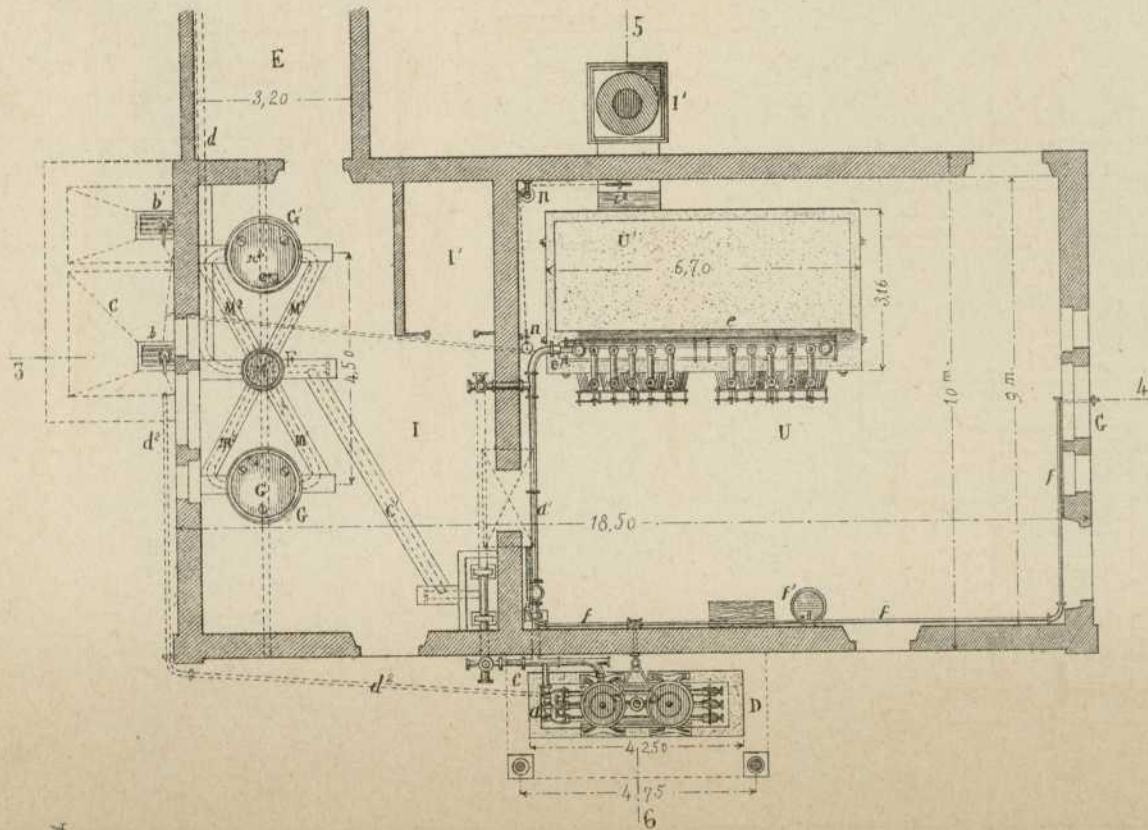


Fig. 1

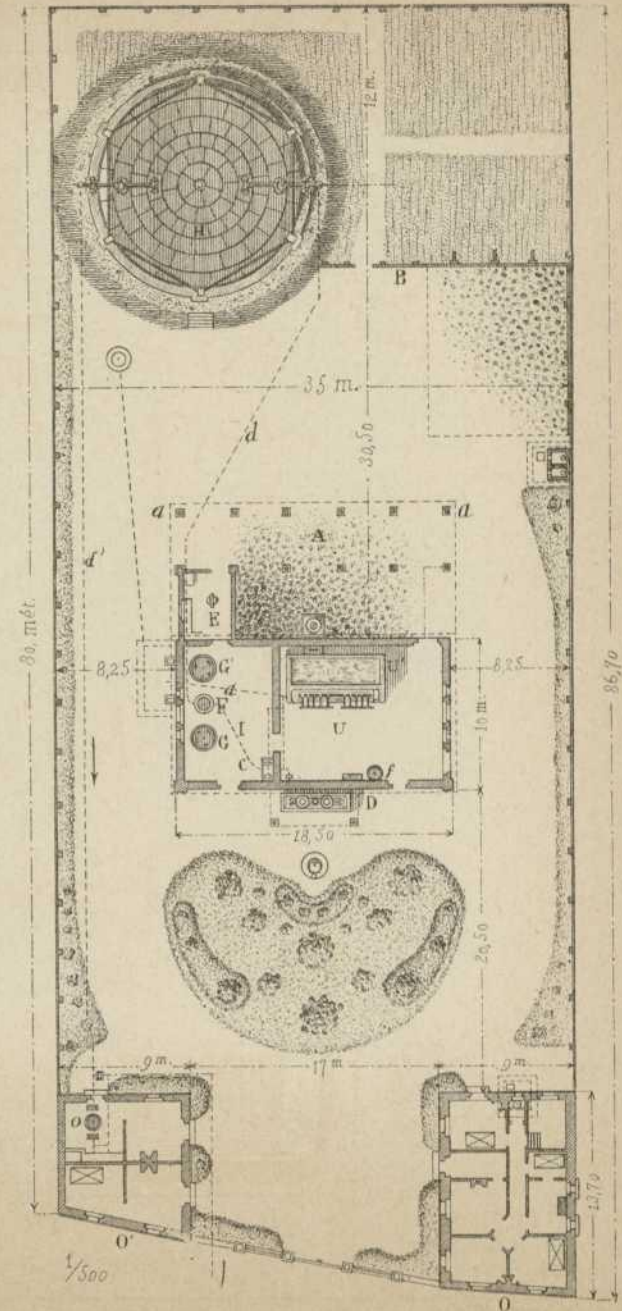
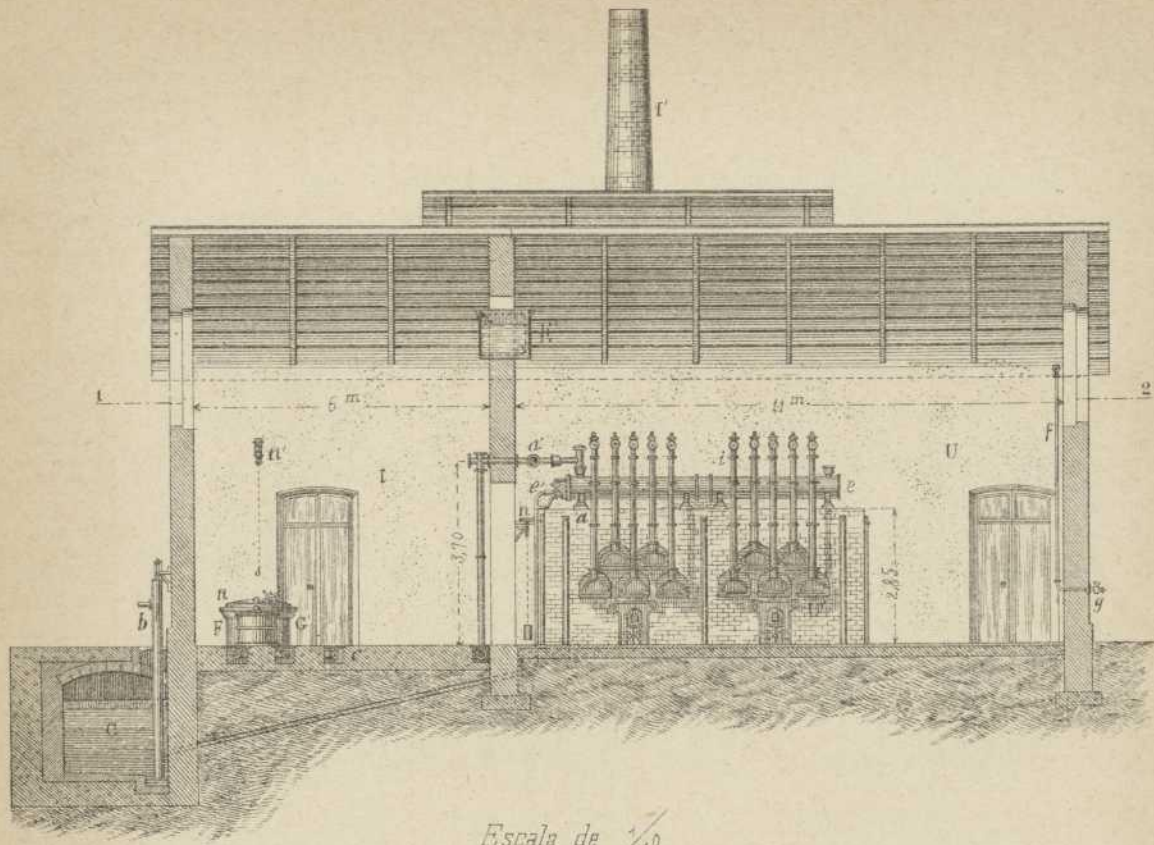


Fig 4



Escala de $\frac{1}{30}$

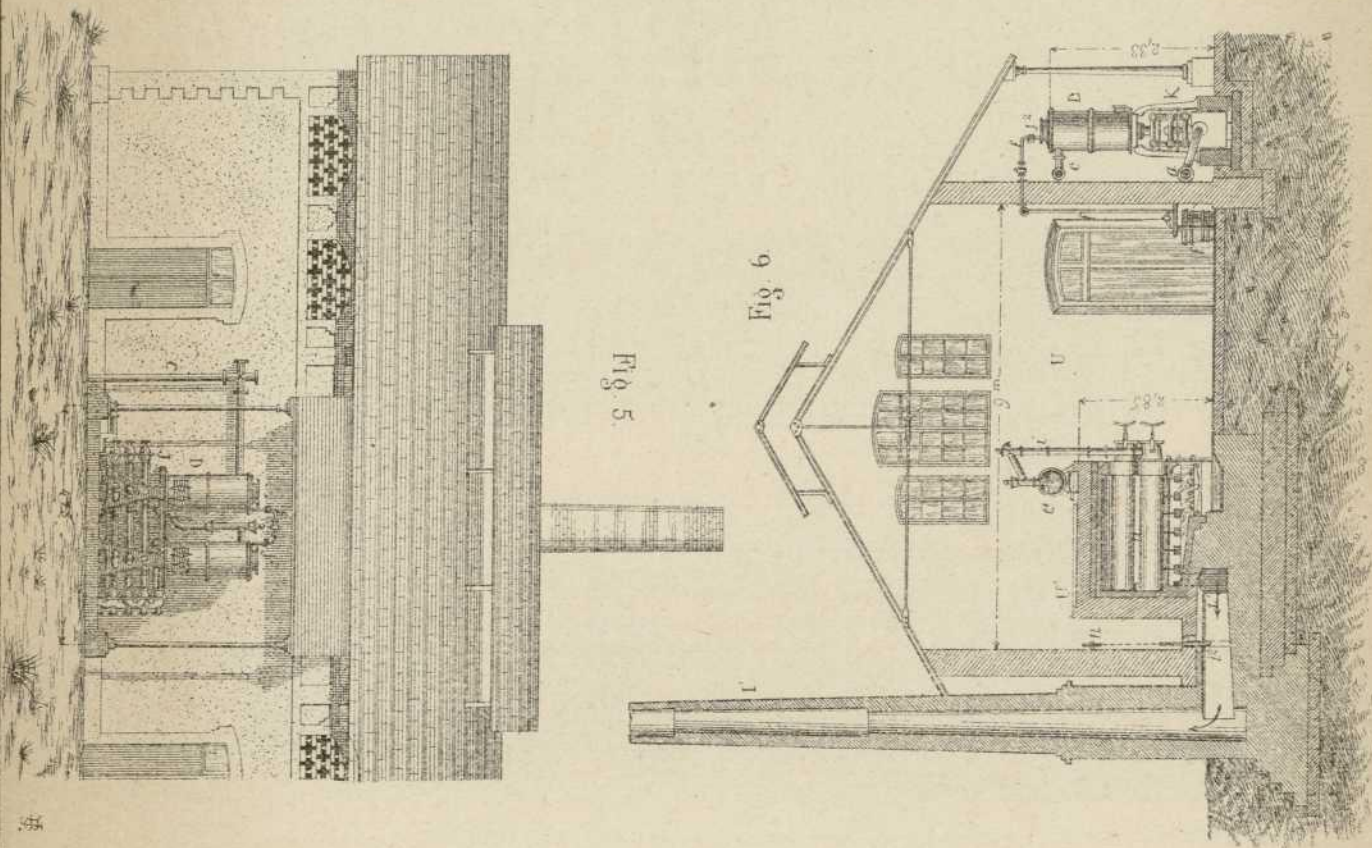


Fig 5

Fig 6

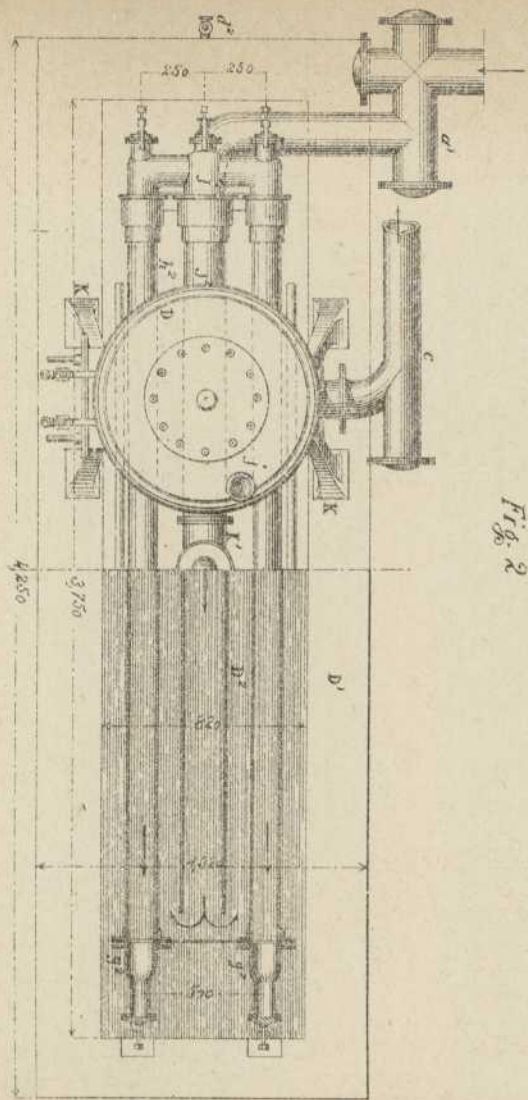
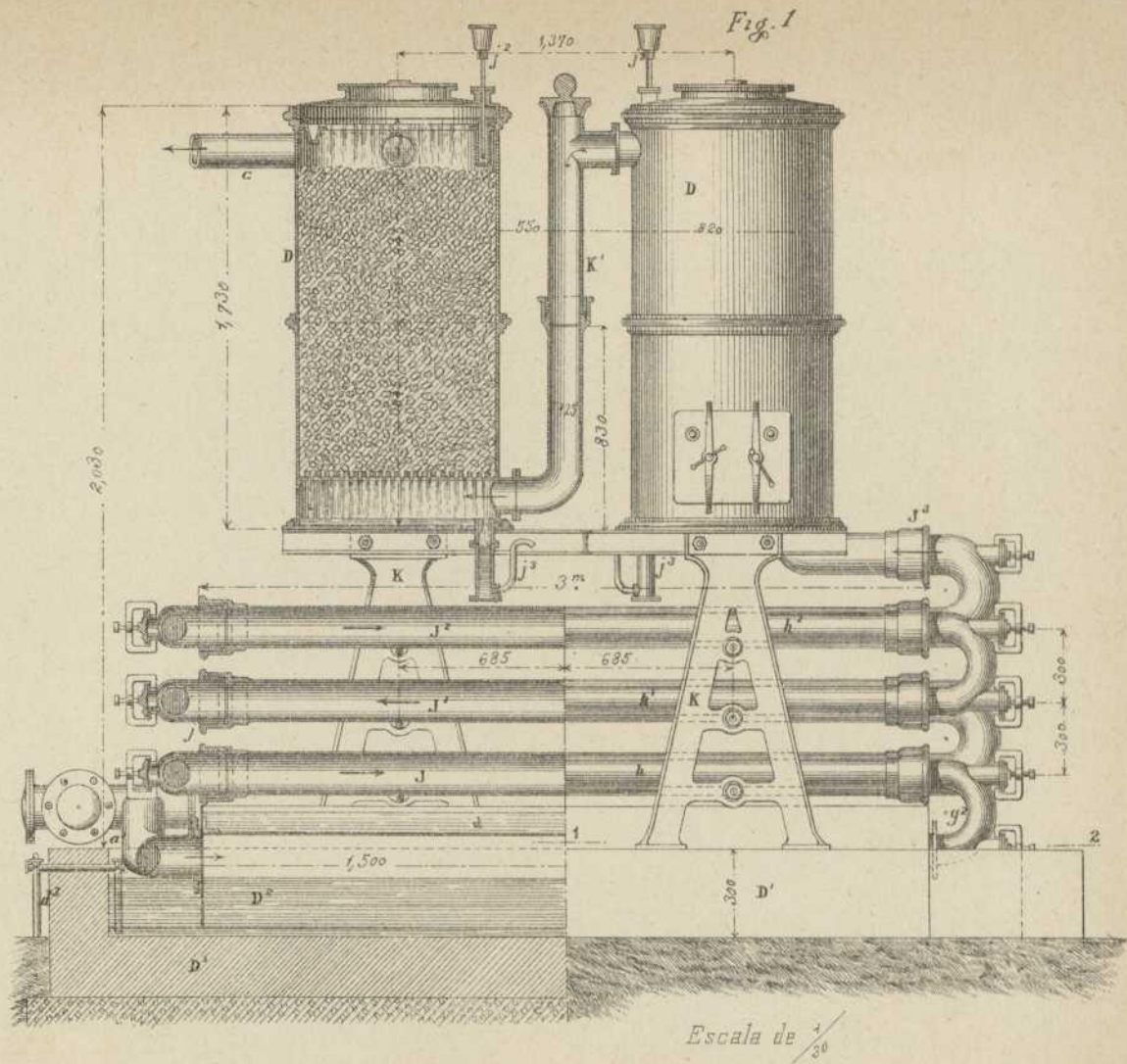


Fig. 2



Escala de $\frac{1}{30}$

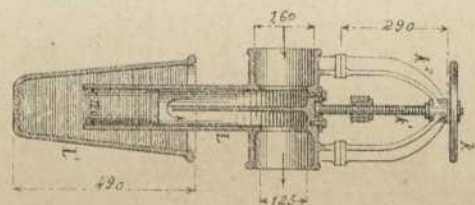


Fig. 4

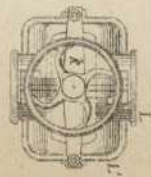


Fig. 6

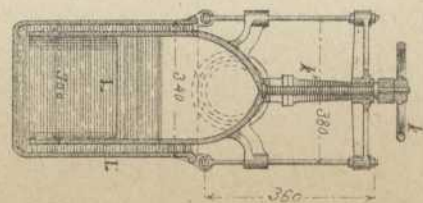
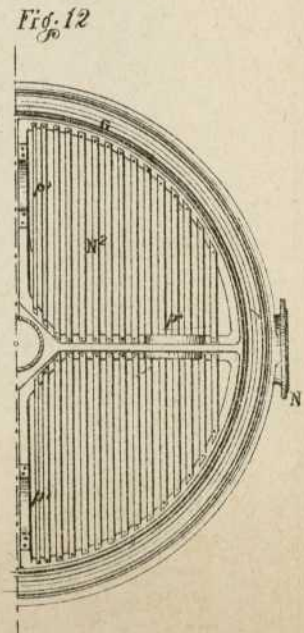
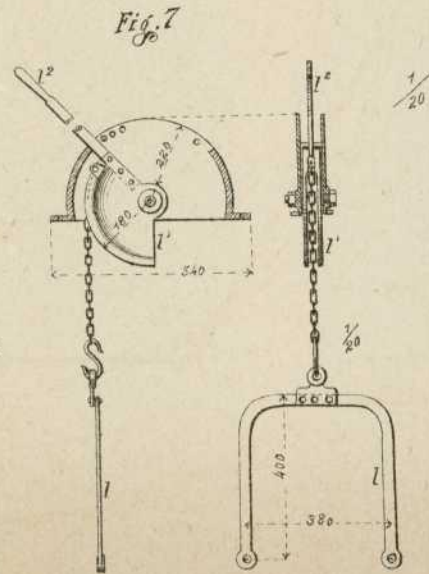
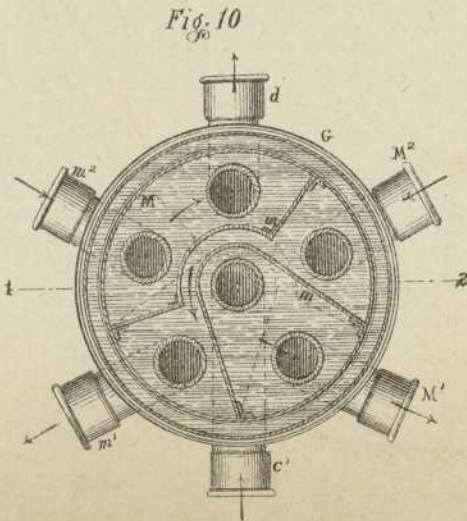
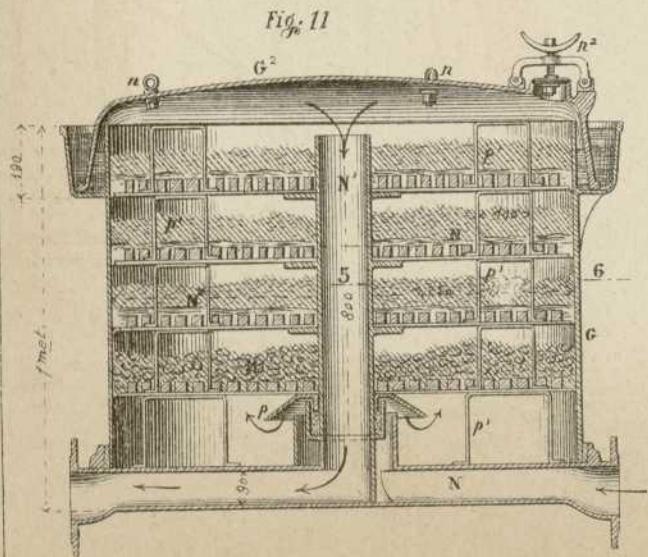
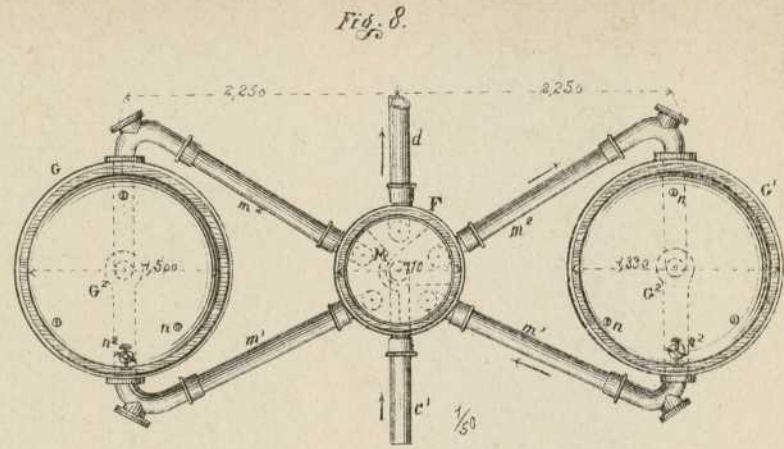
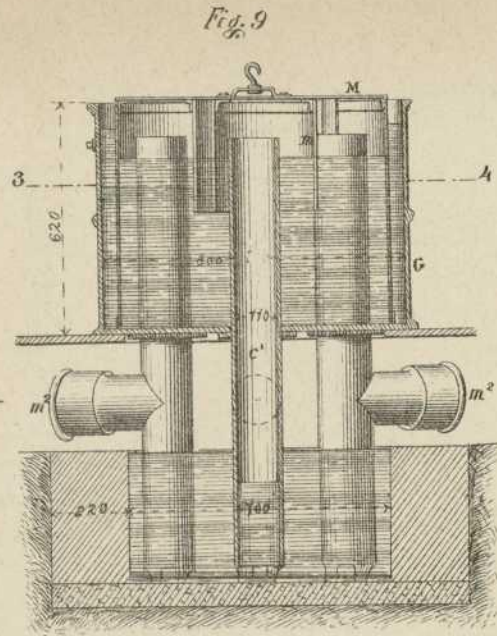
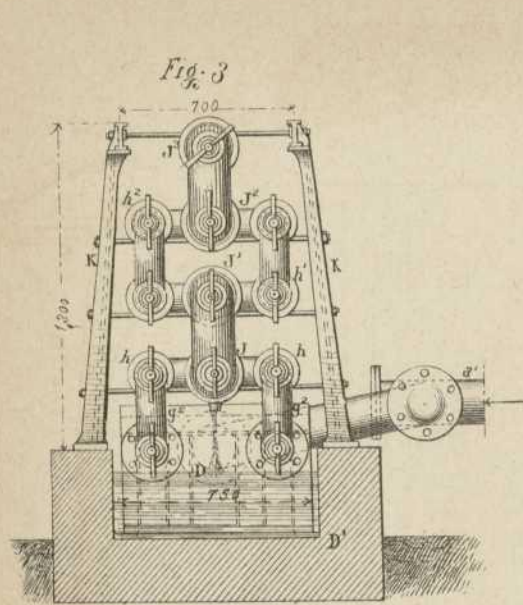
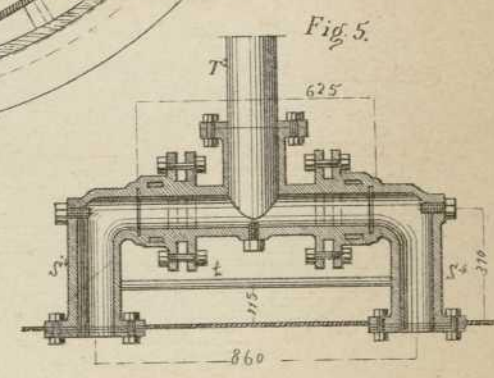
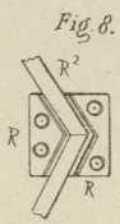
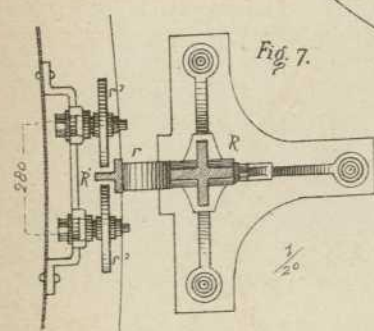
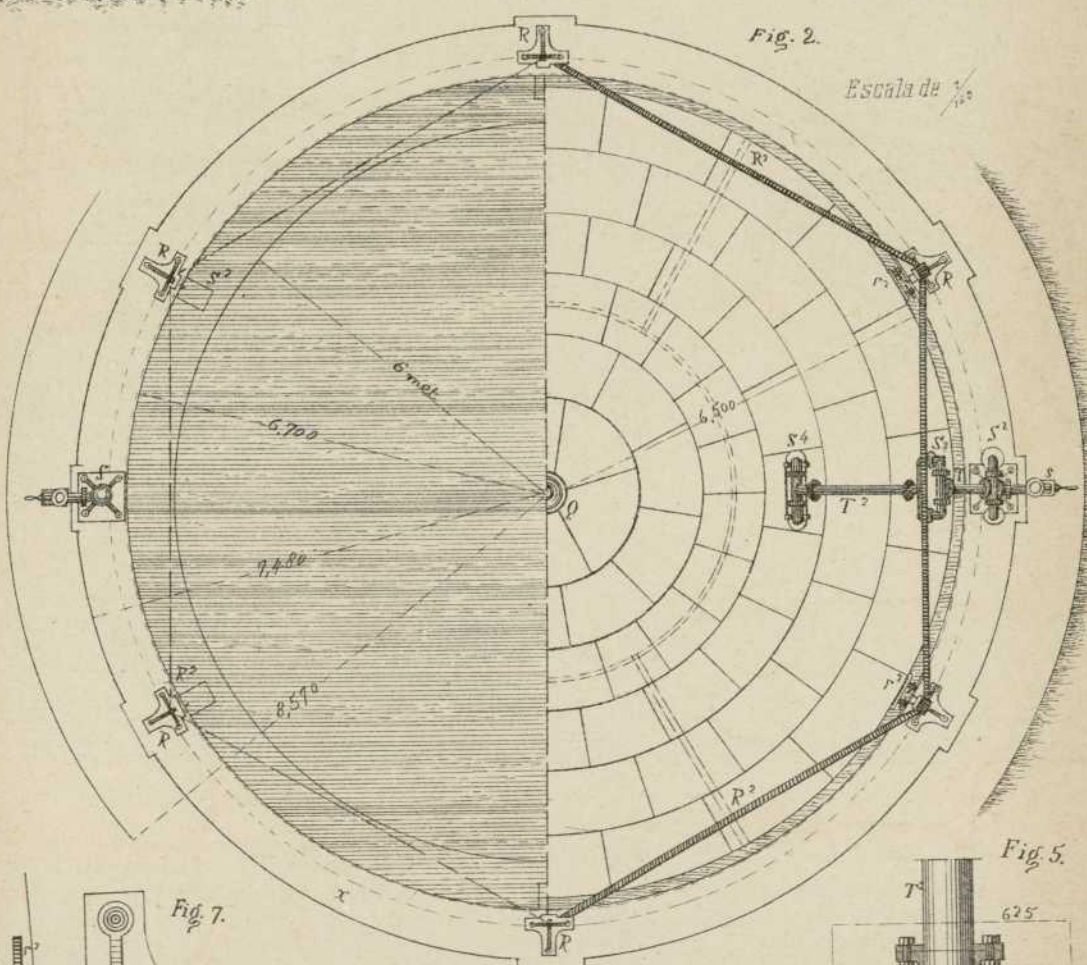
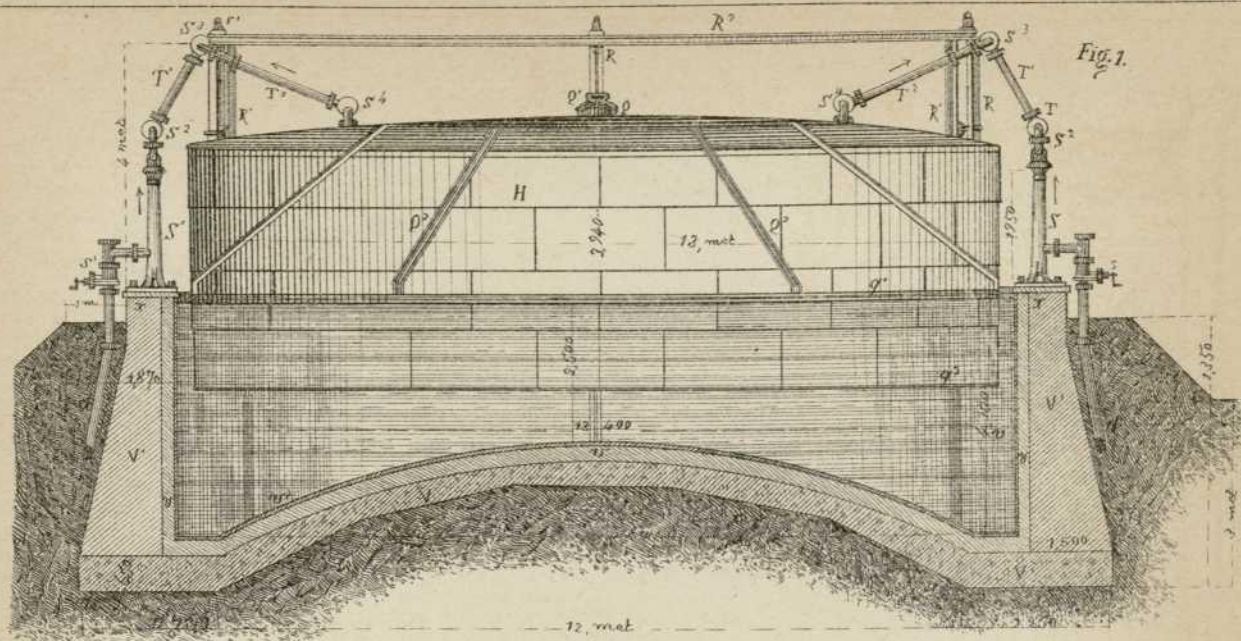
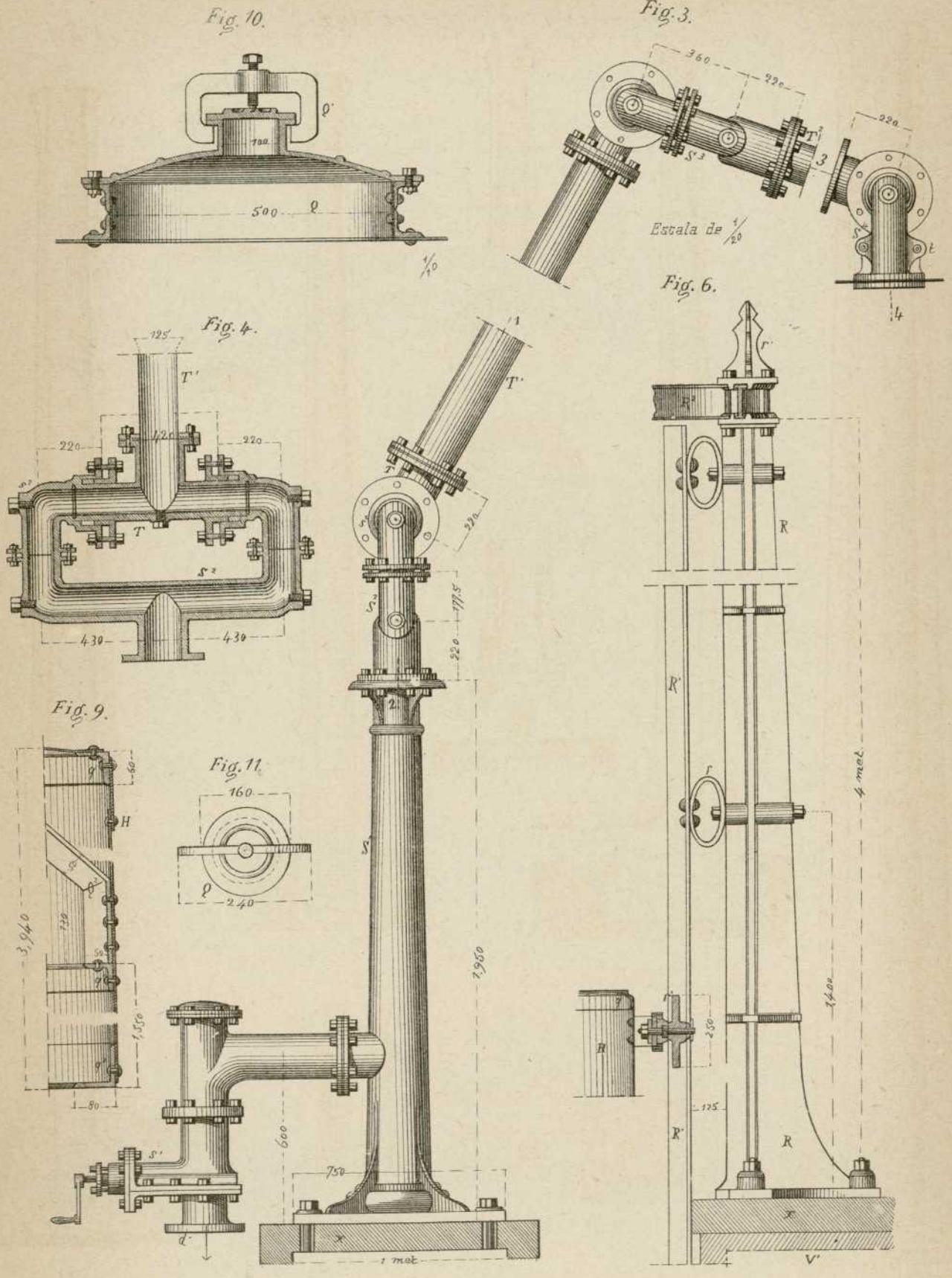
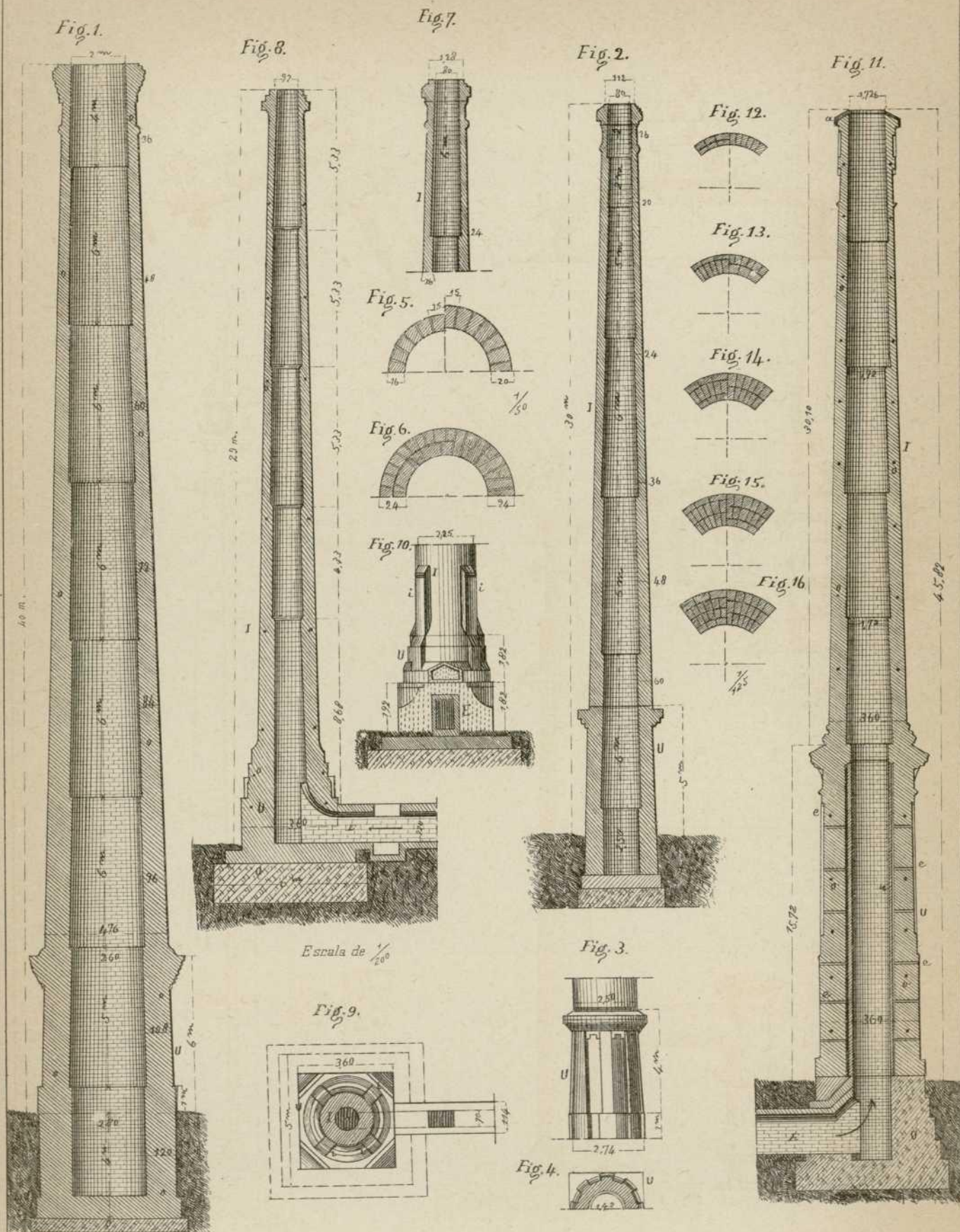


Fig. 5









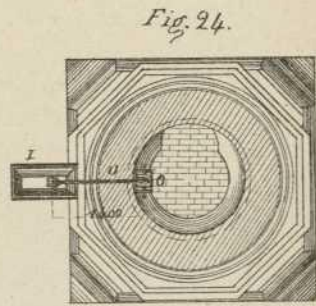
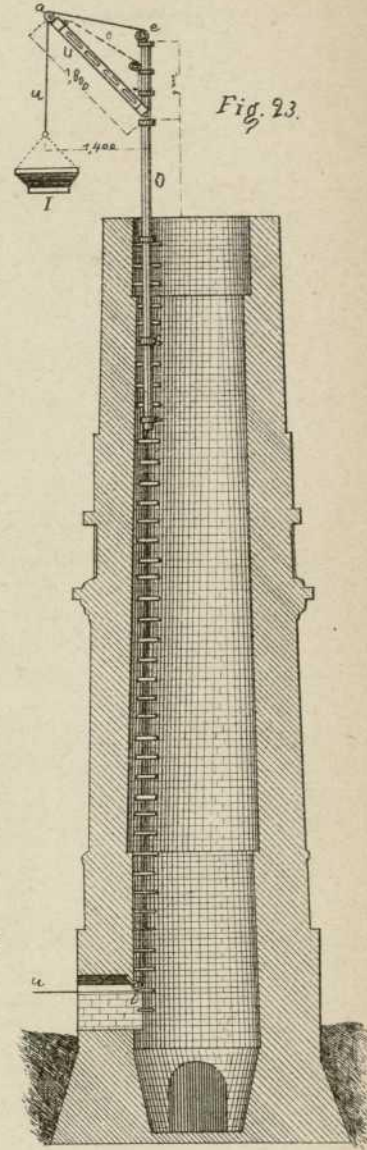
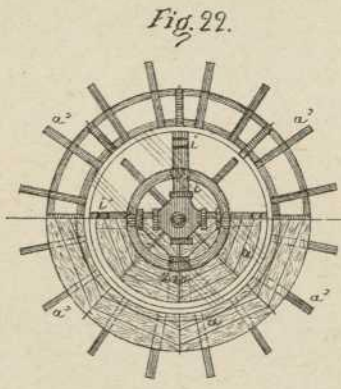
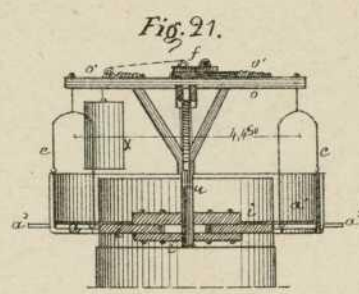
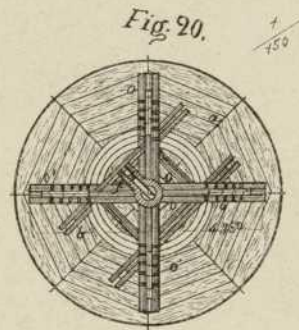
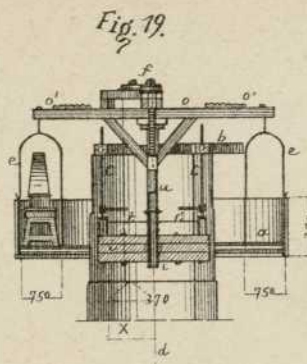
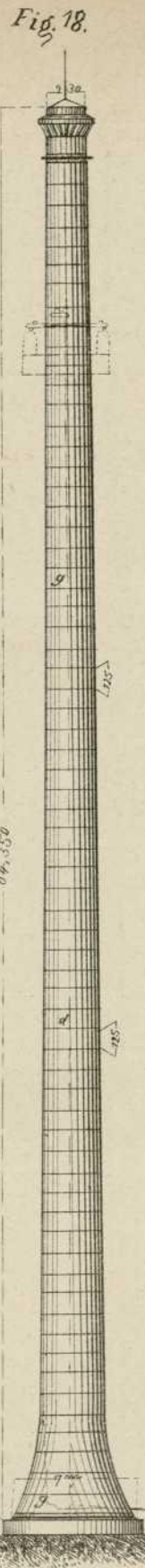
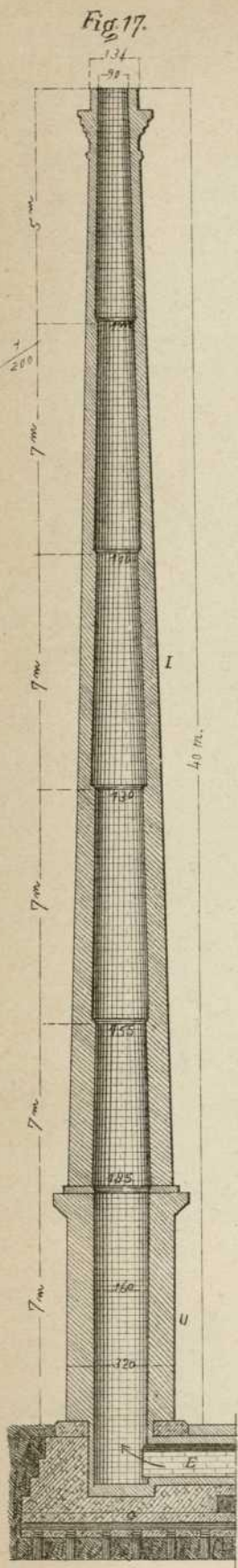


Fig. 1.

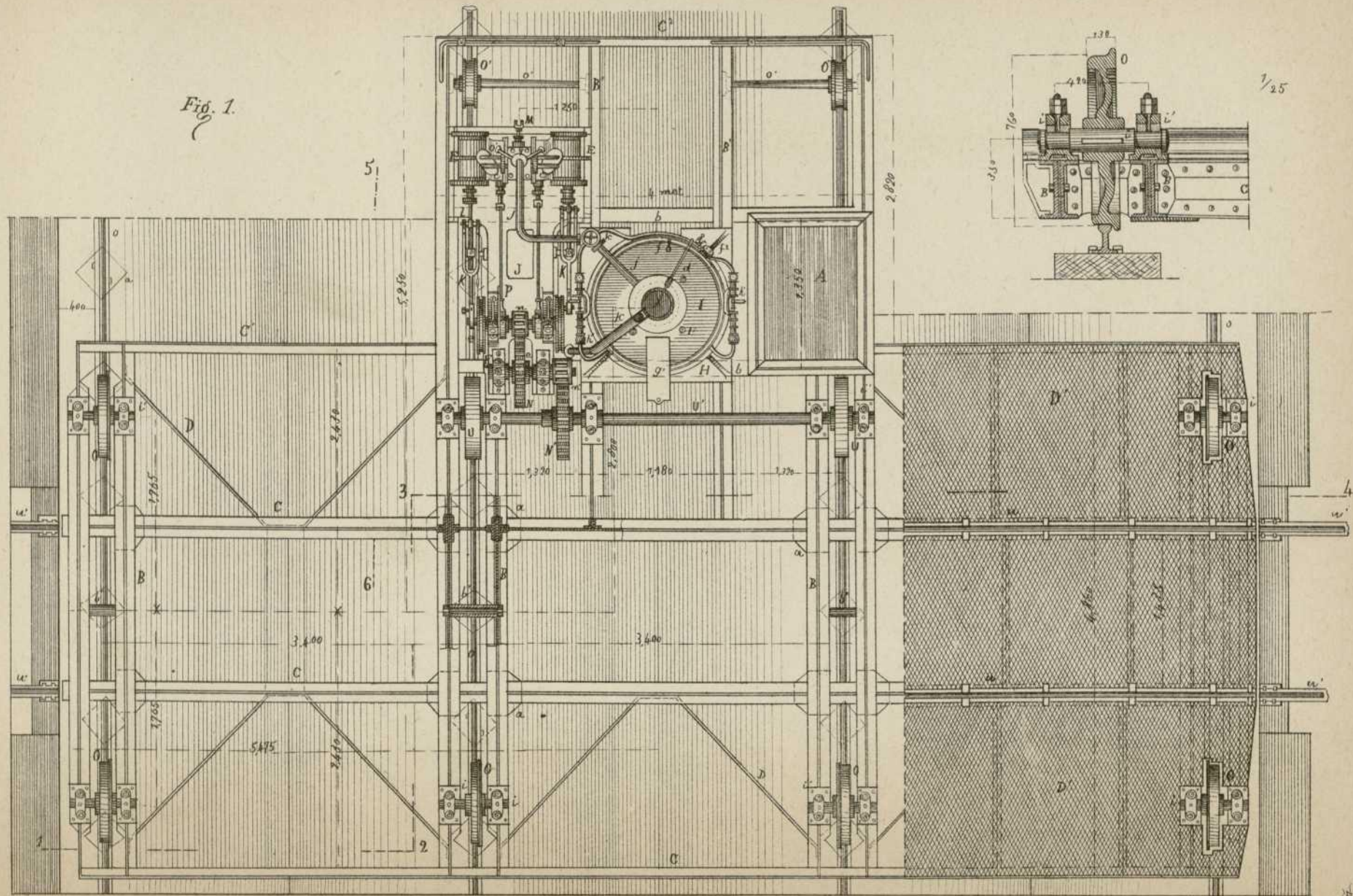
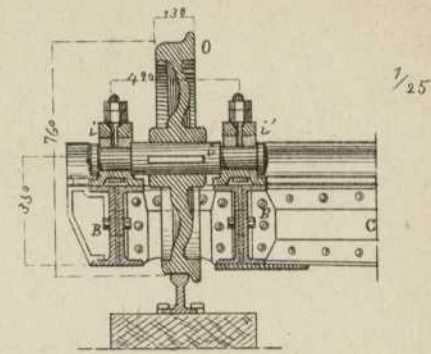
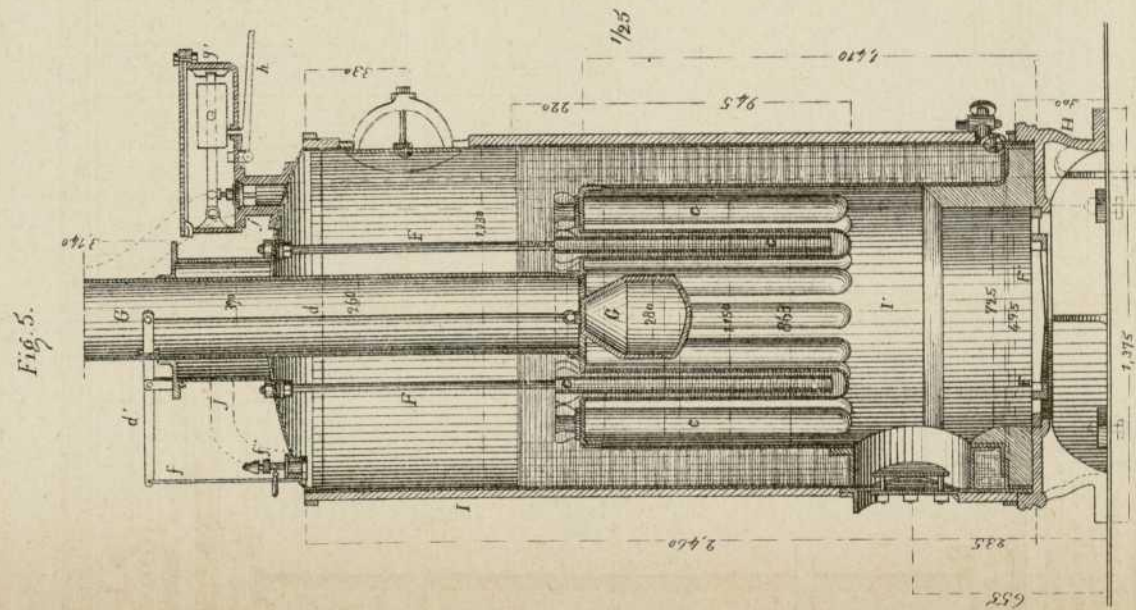
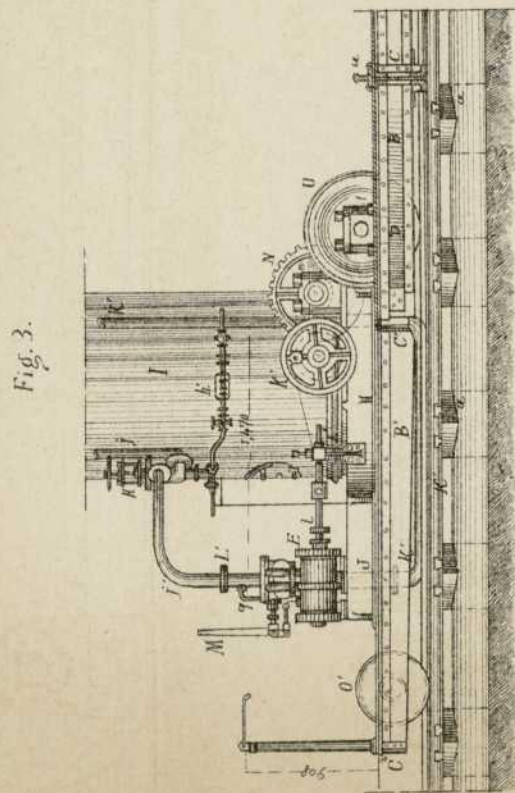
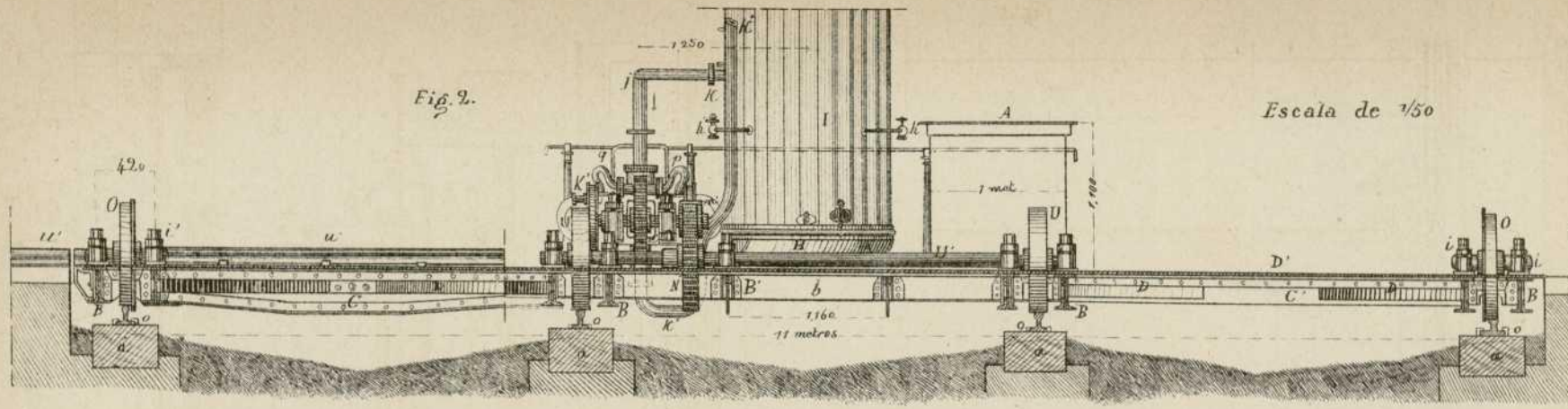
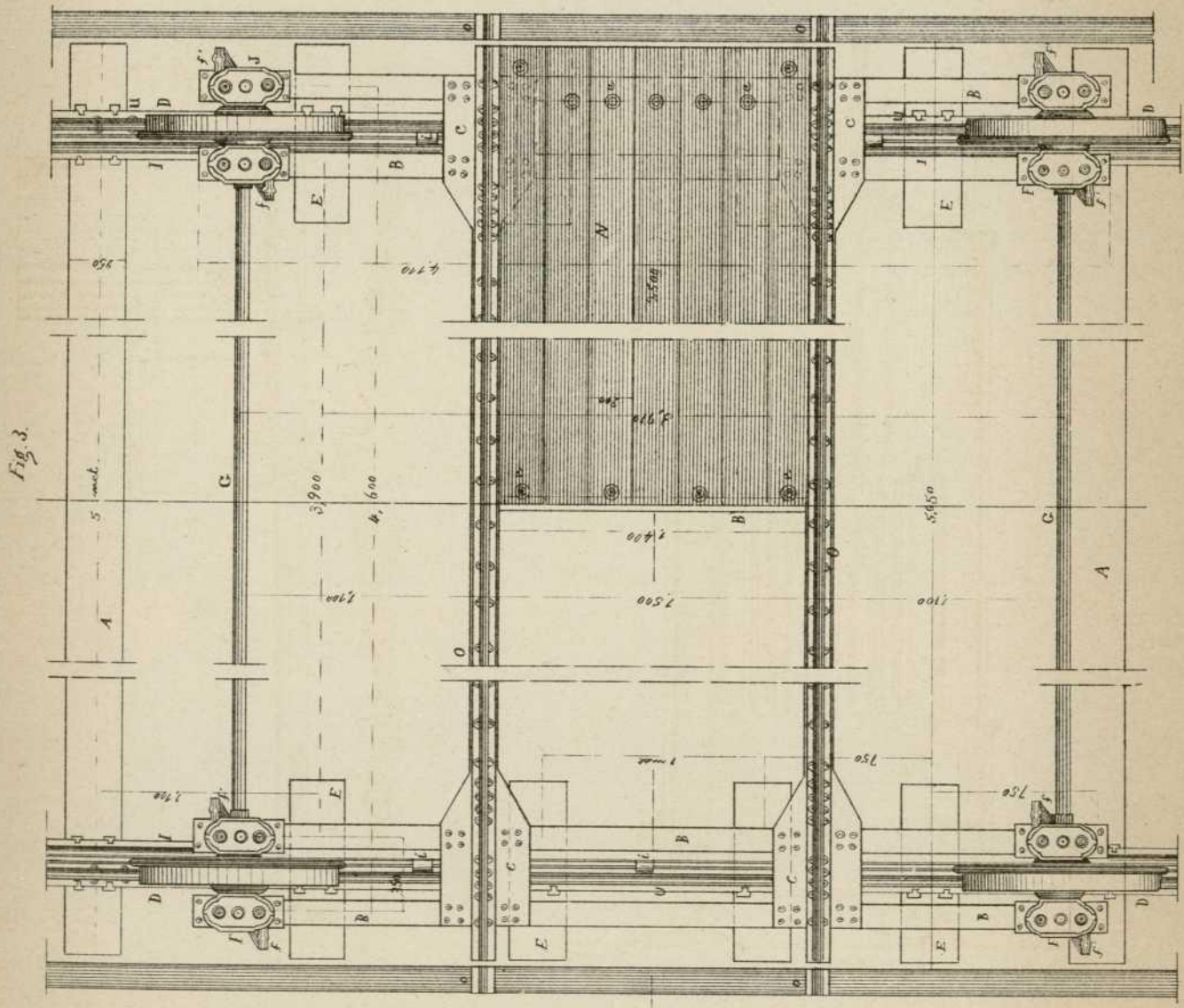
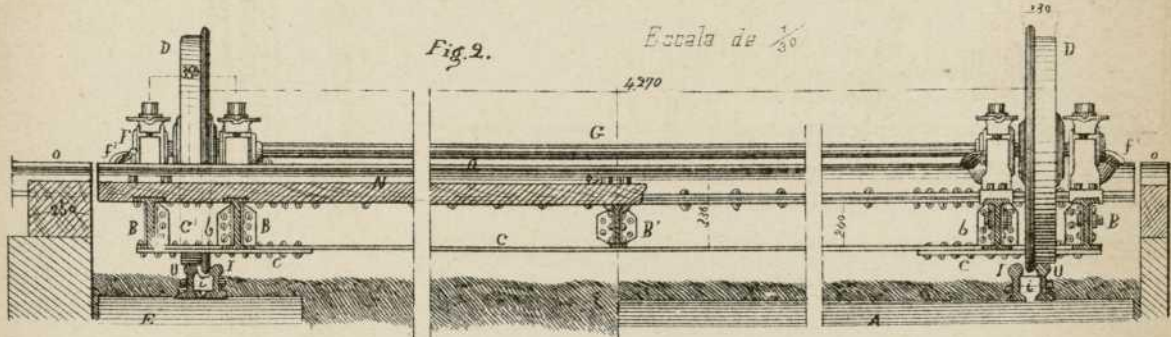
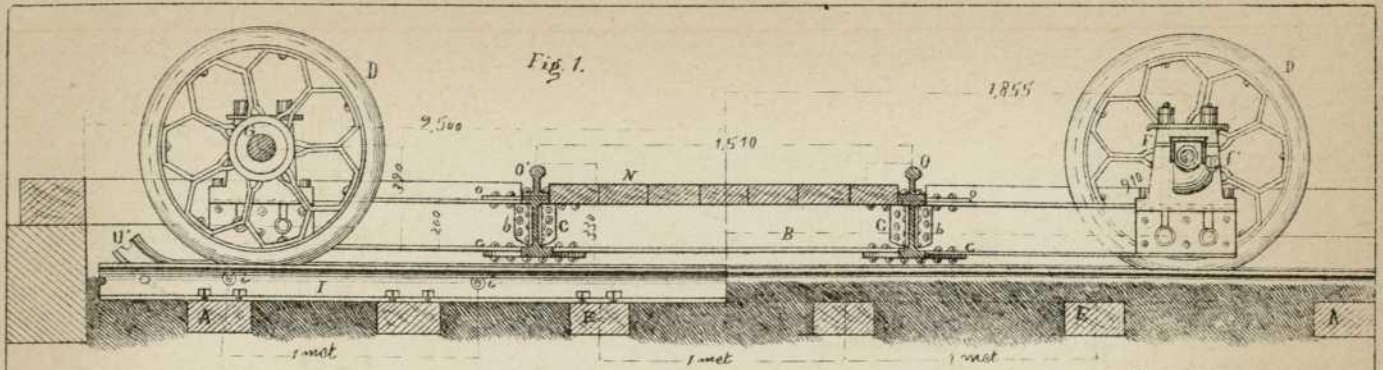
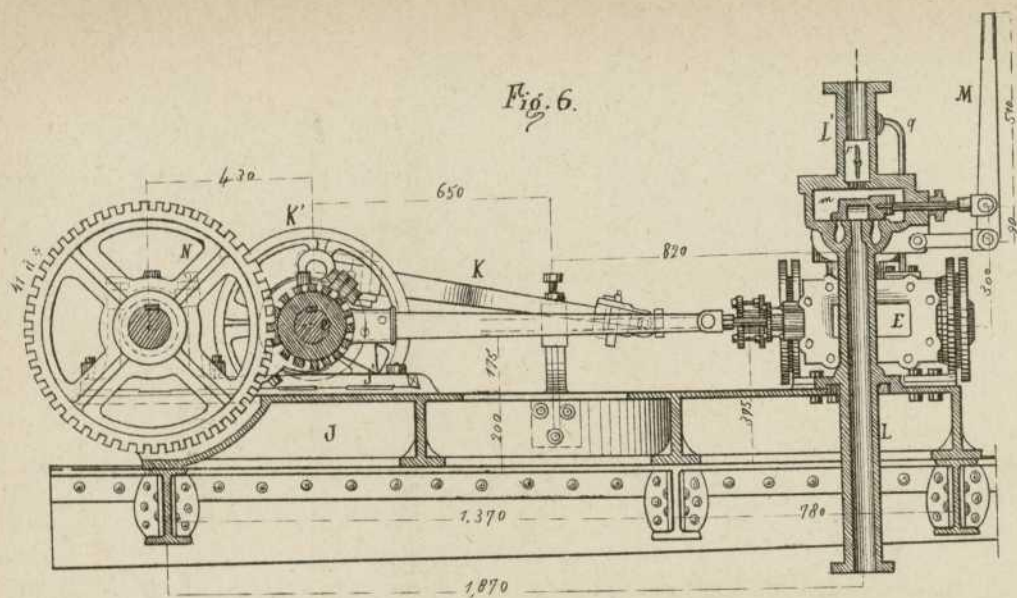


Fig. 4.









Escala de $\frac{1}{20}$

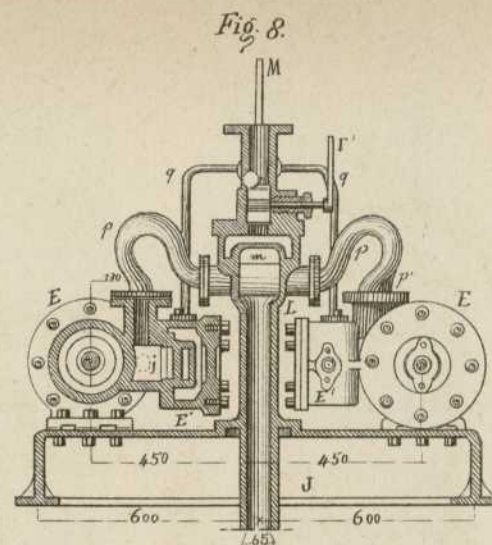
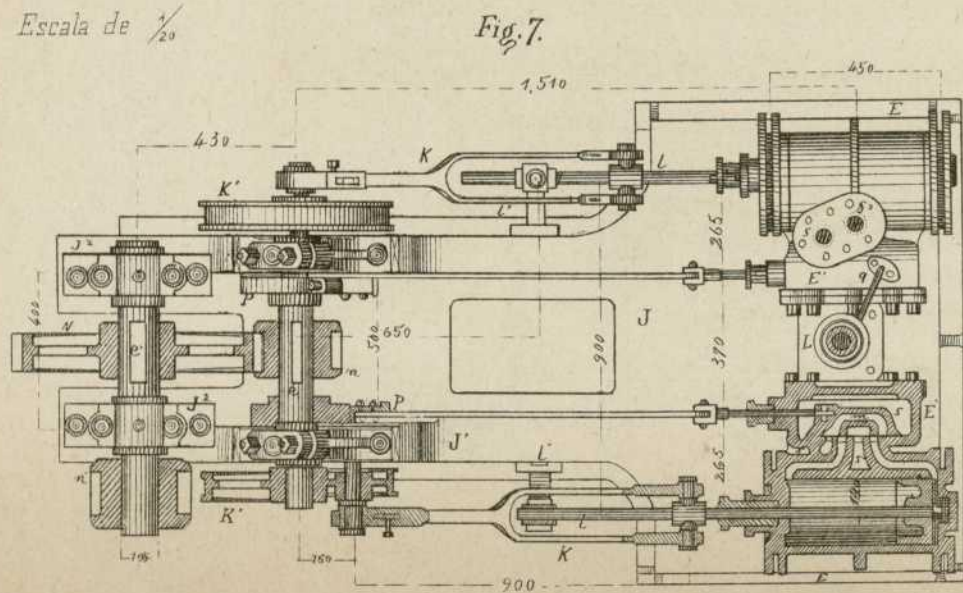


Fig. 5.

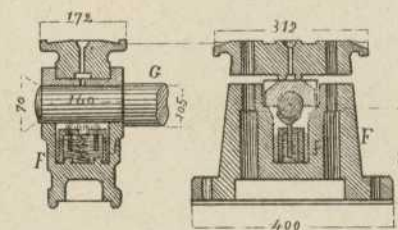
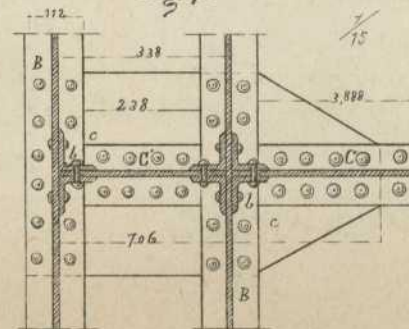
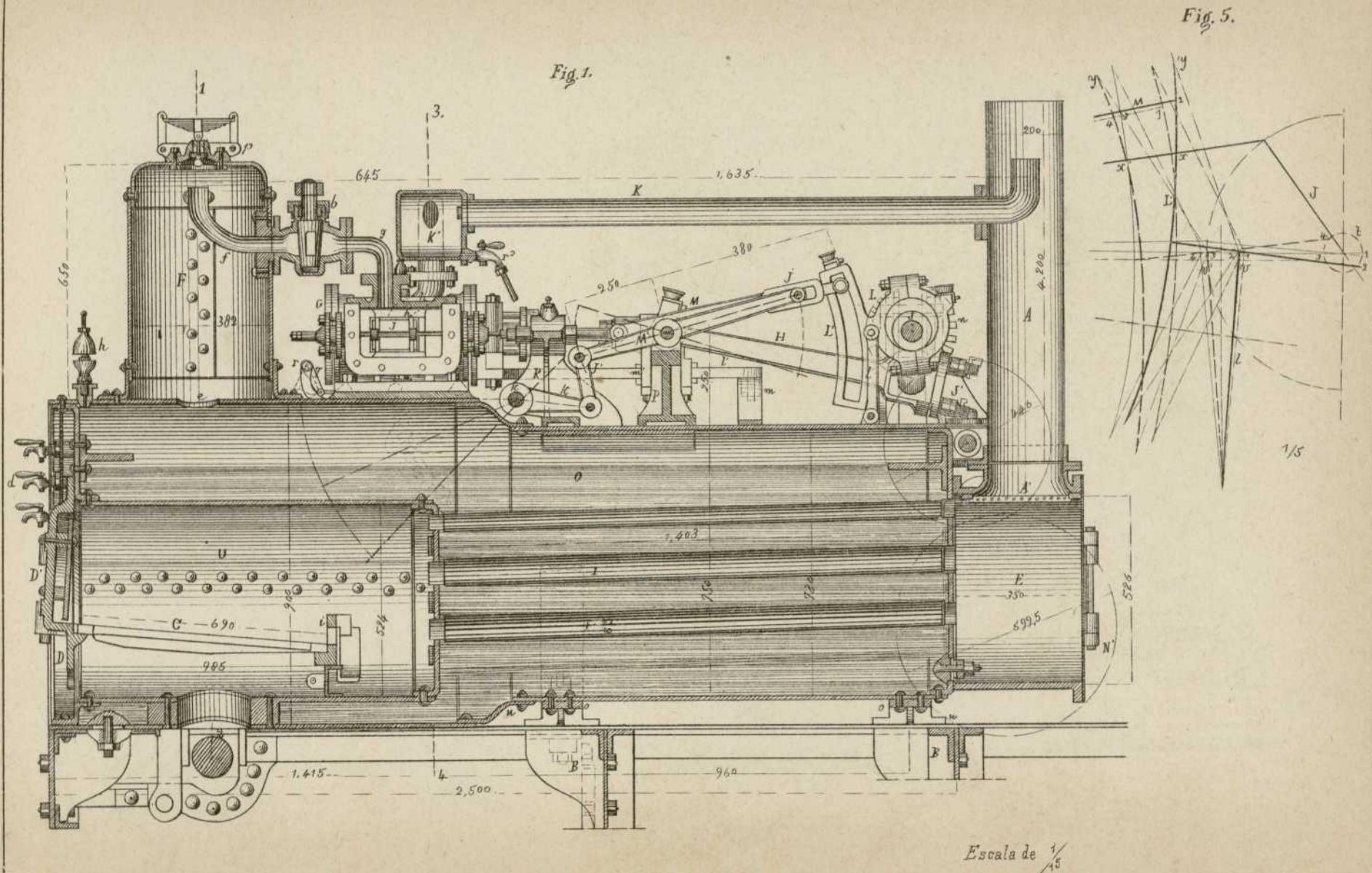


Fig. 4.





Escala de $\frac{1}{5}$

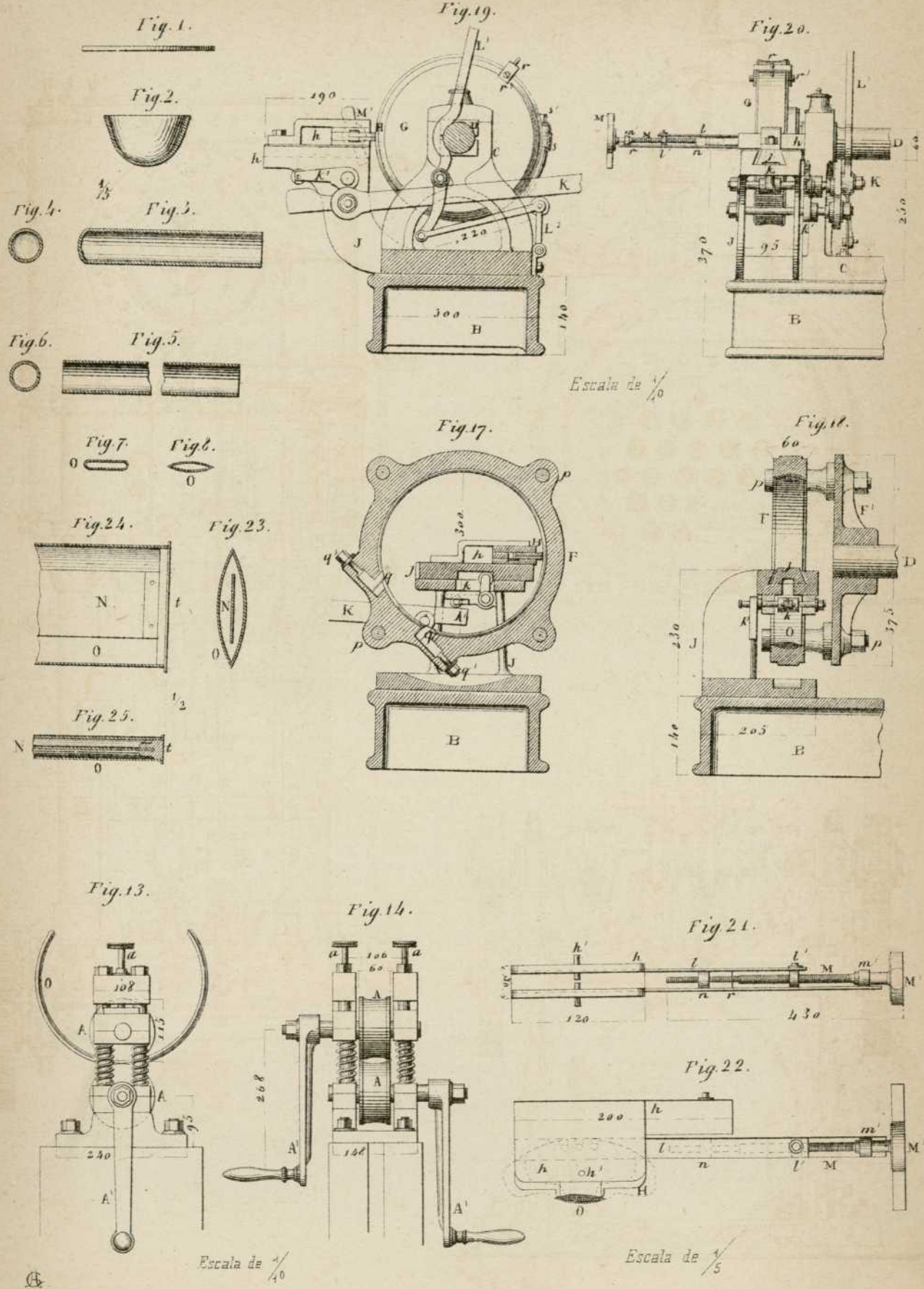


Fig. 15.

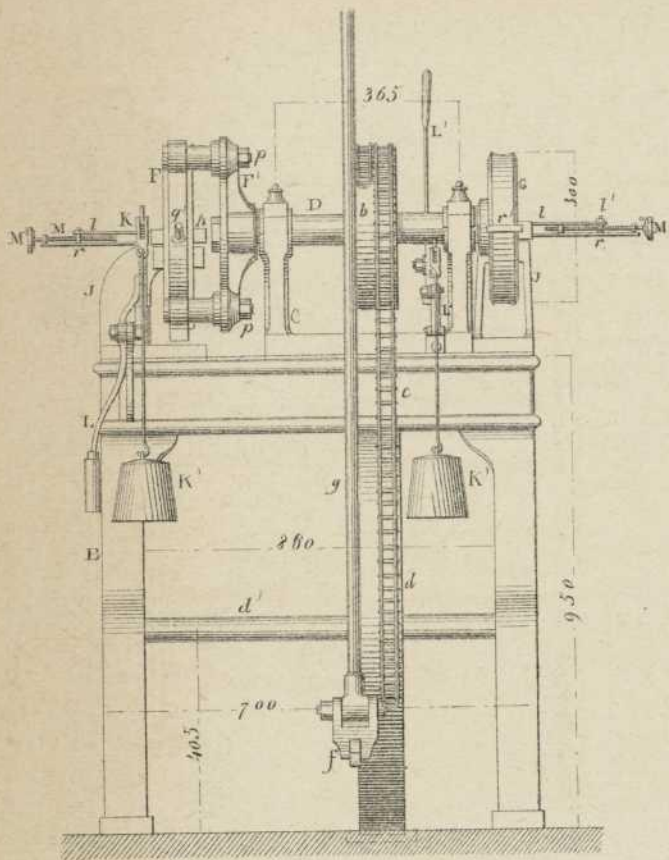


Fig. 16.

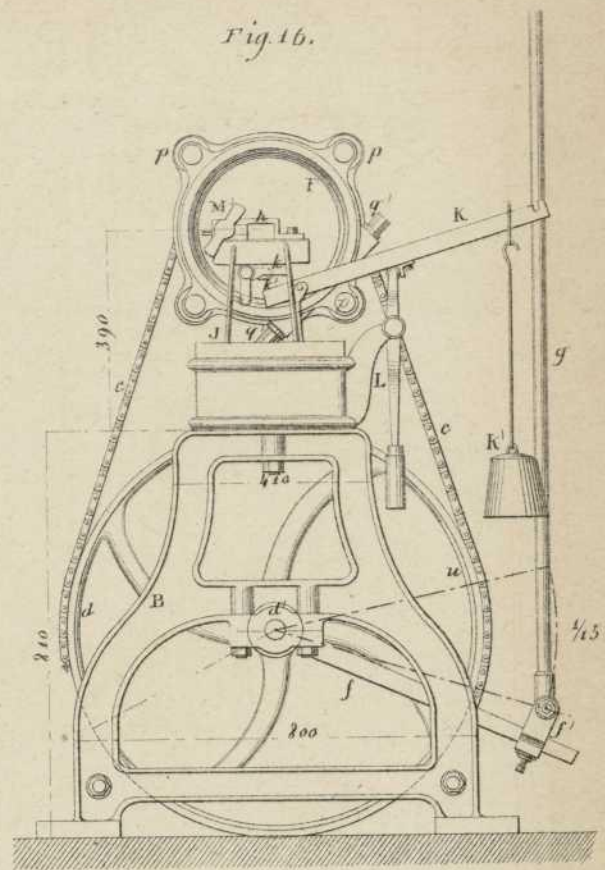


Fig. 9.

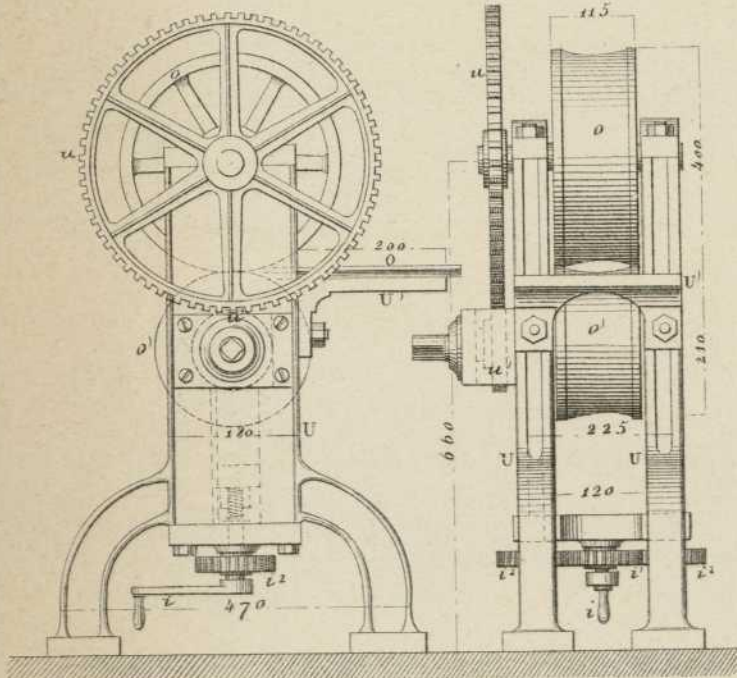


Fig. 10.

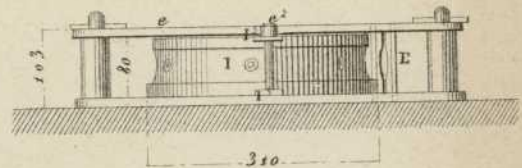


Fig. 11.

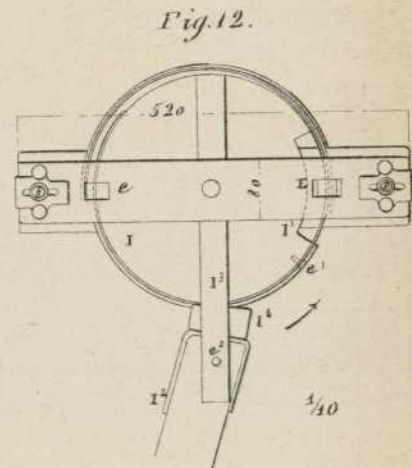
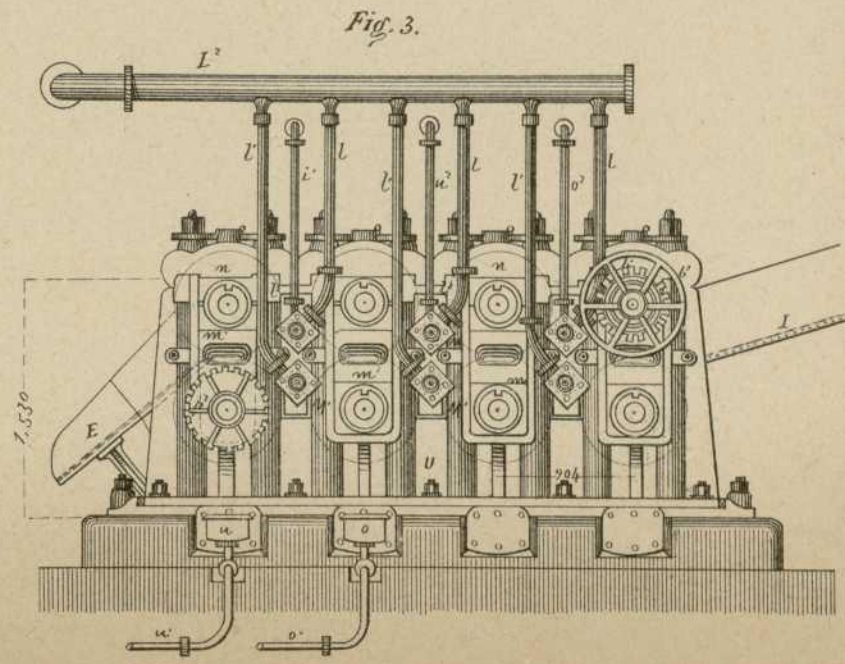
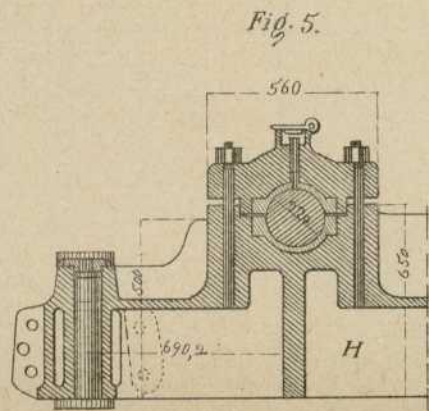
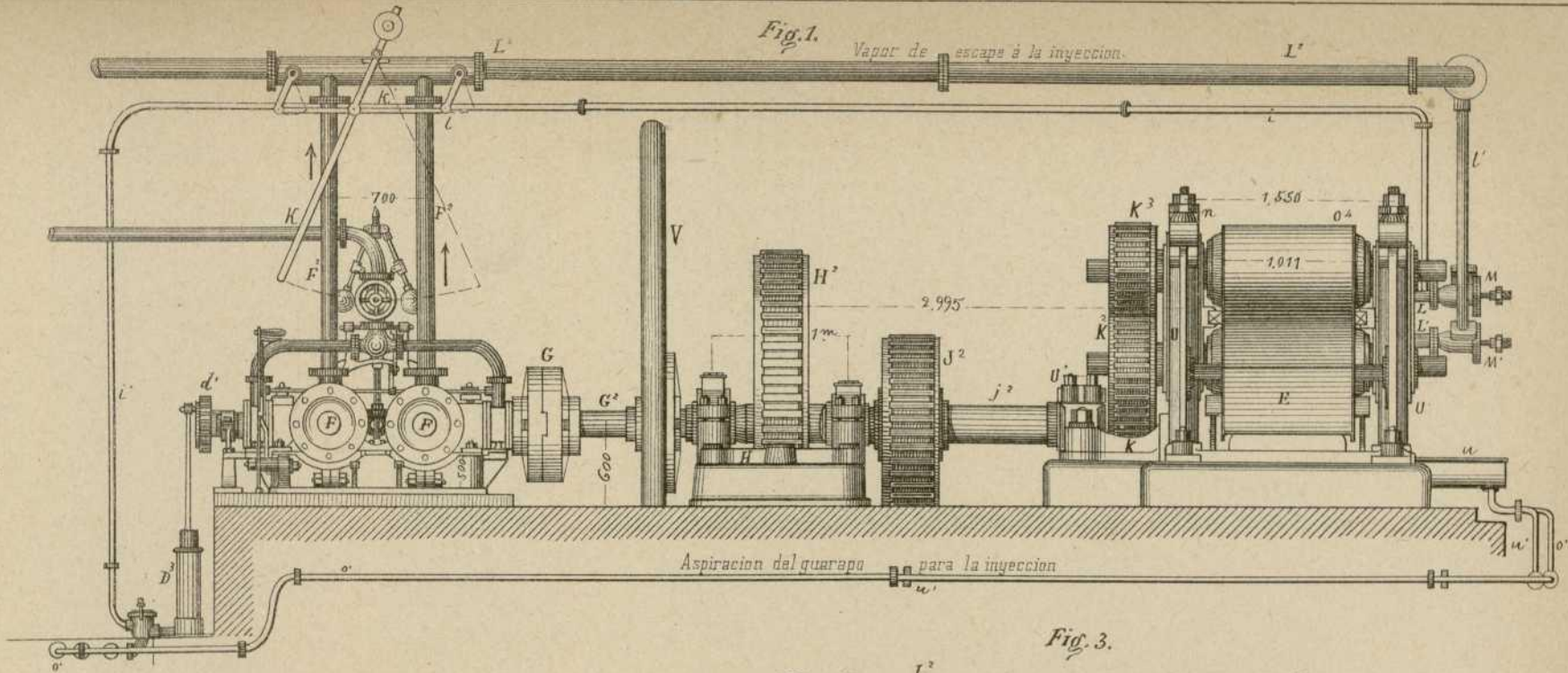
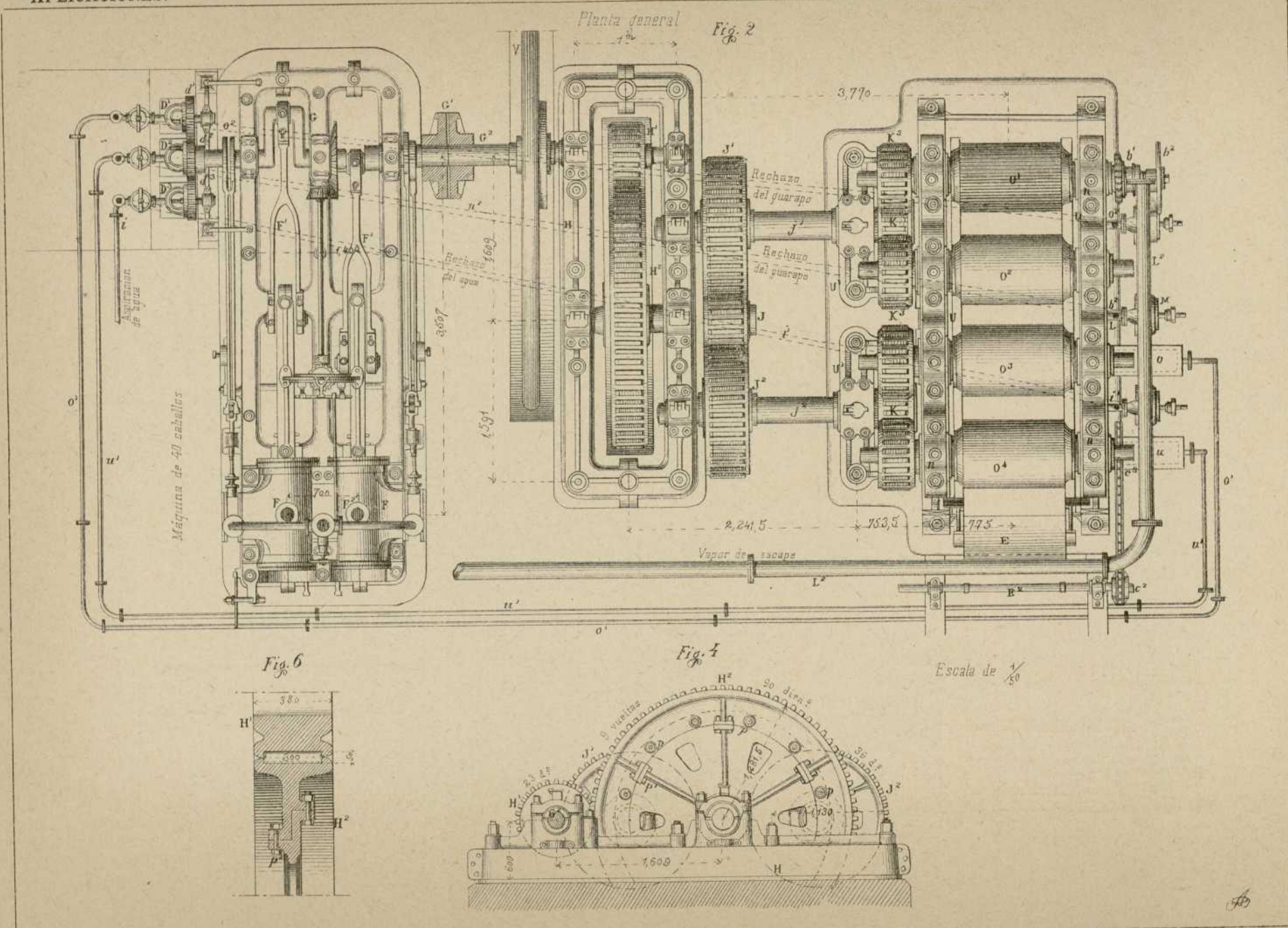
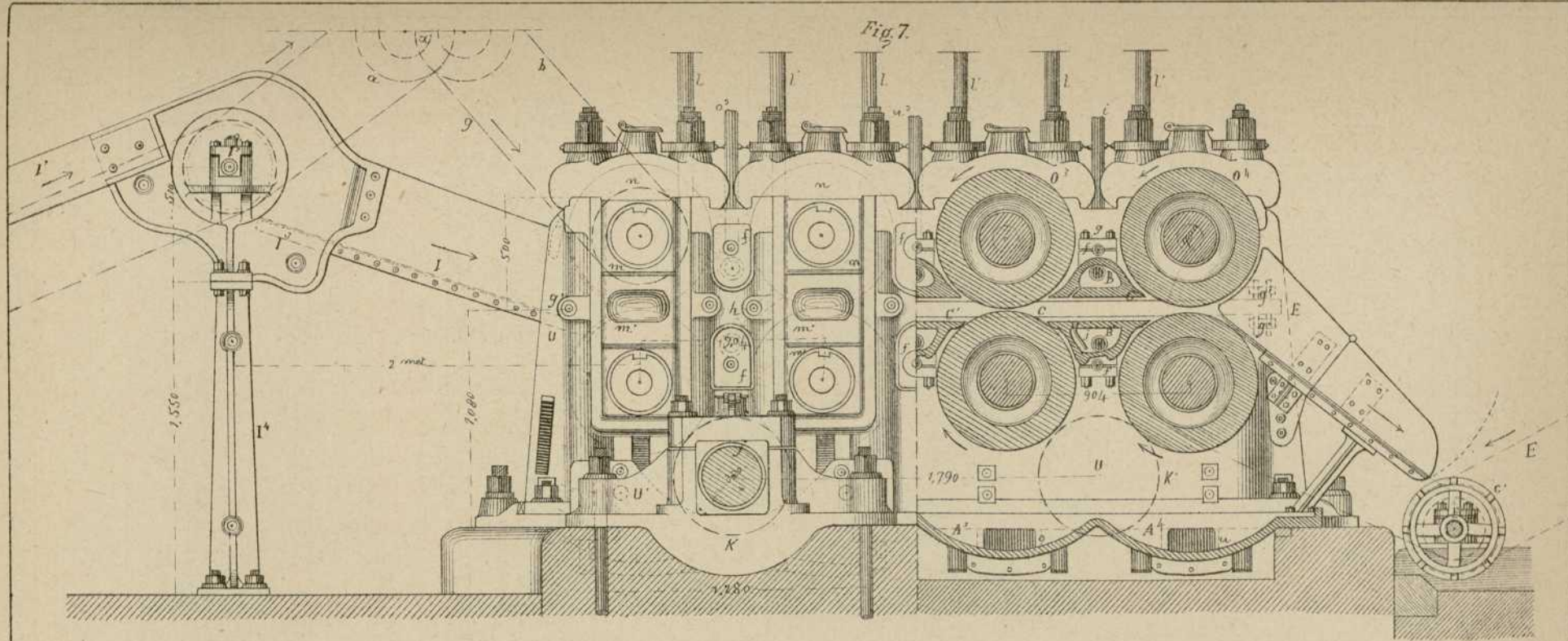


Fig. 12.







Escala de $\frac{1}{30}$

Fig. 9.

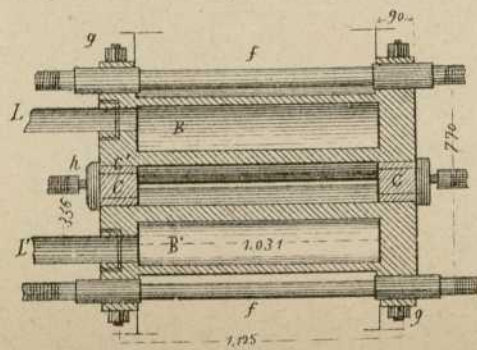


Fig. 10.

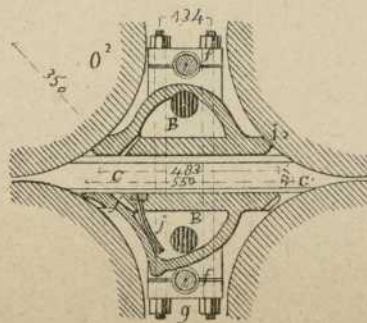
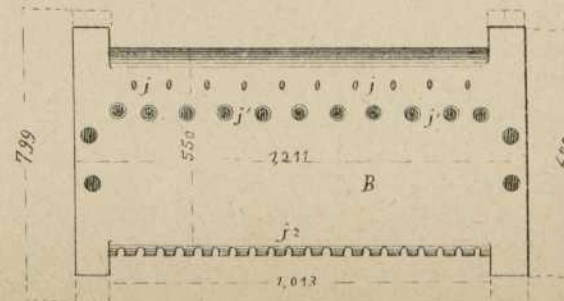
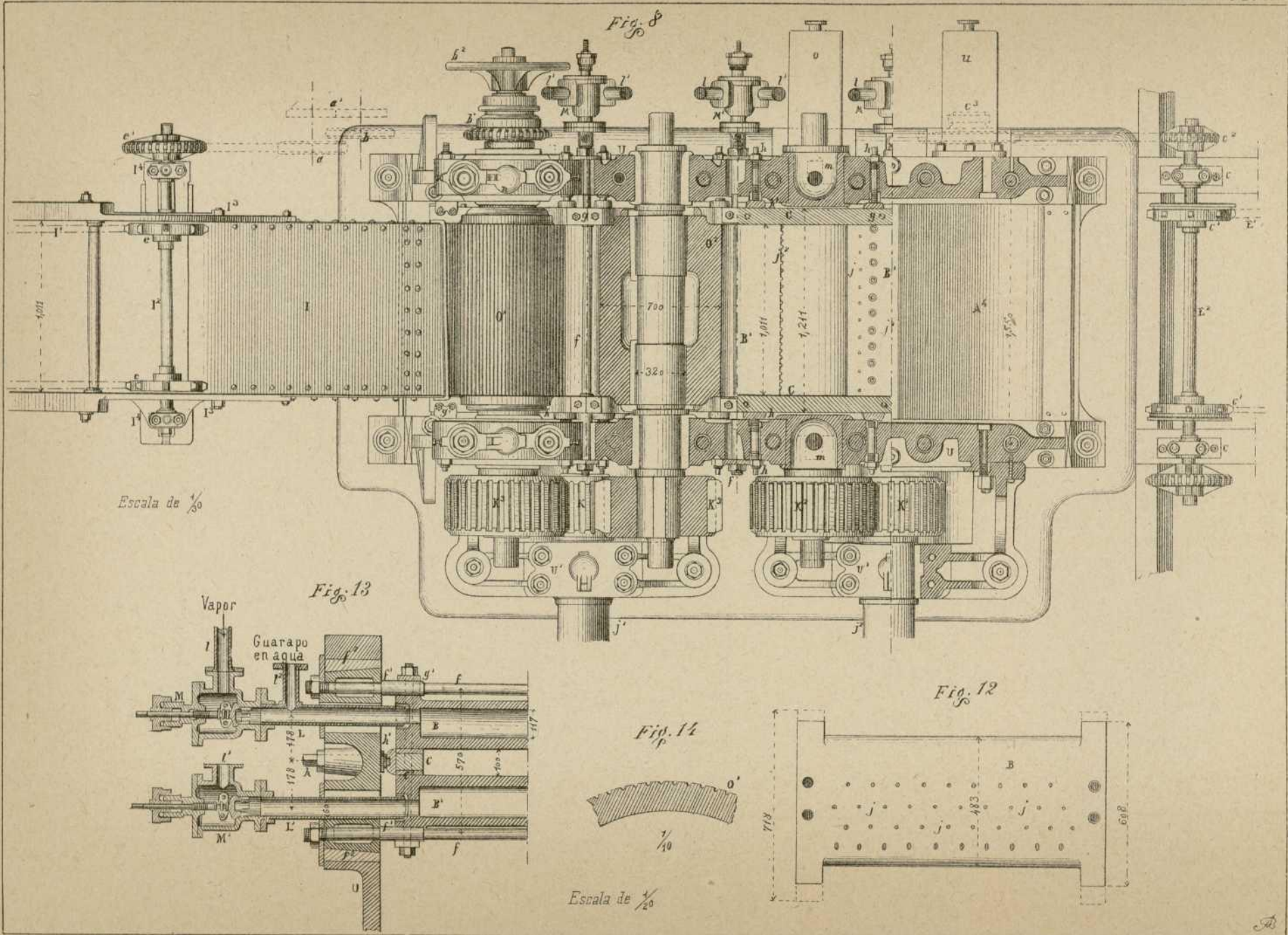


Fig. 11.





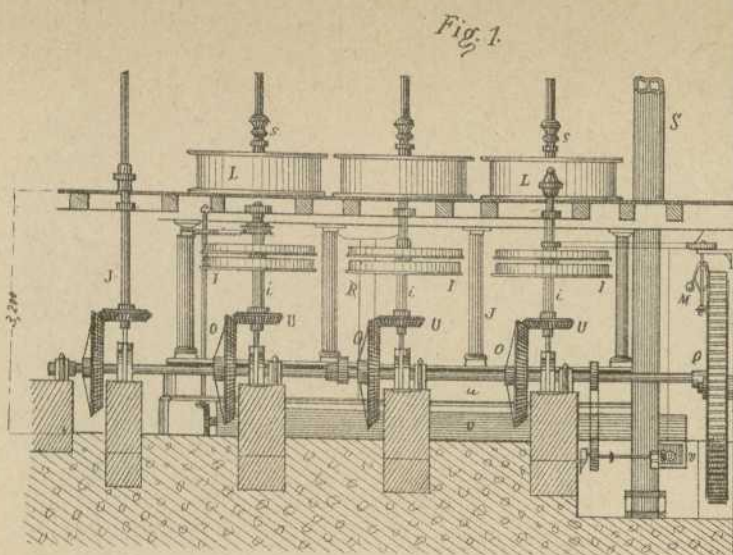


Fig. 1.

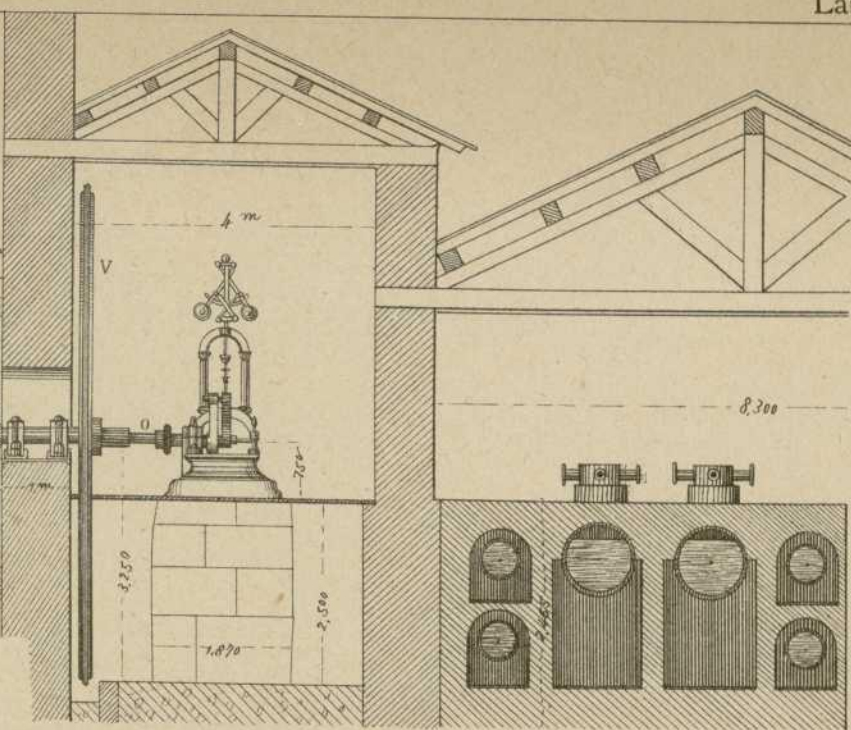


Fig. 3.

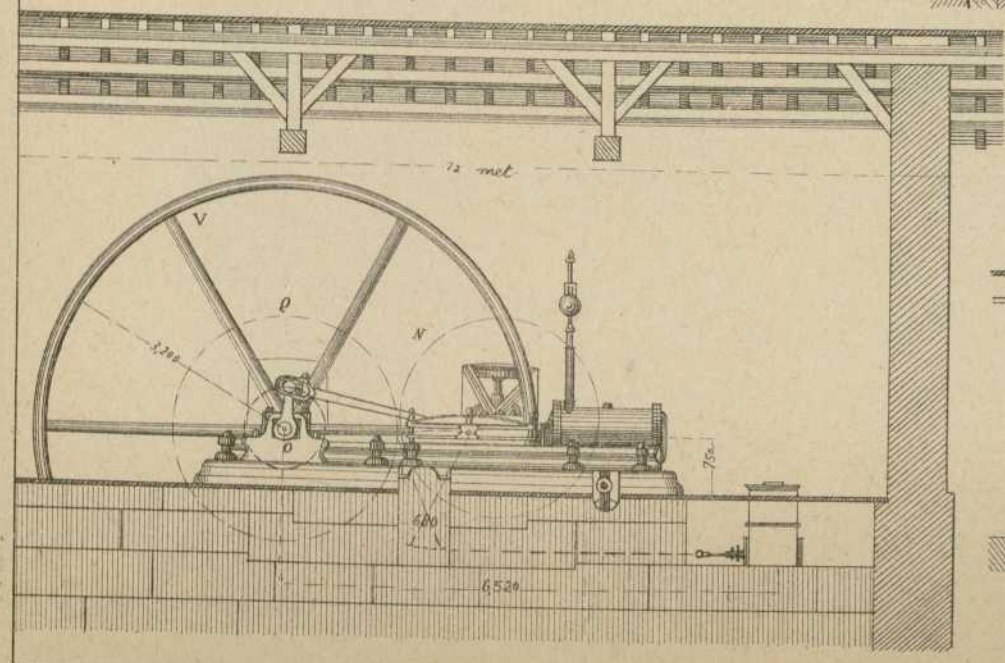
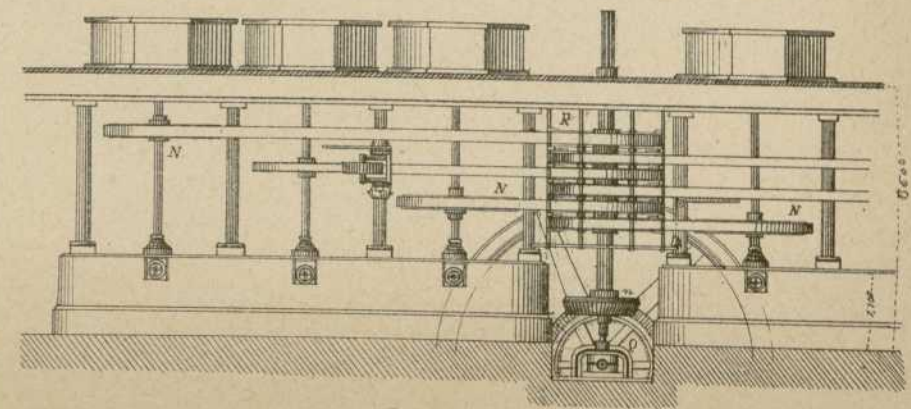


Fig. 4.



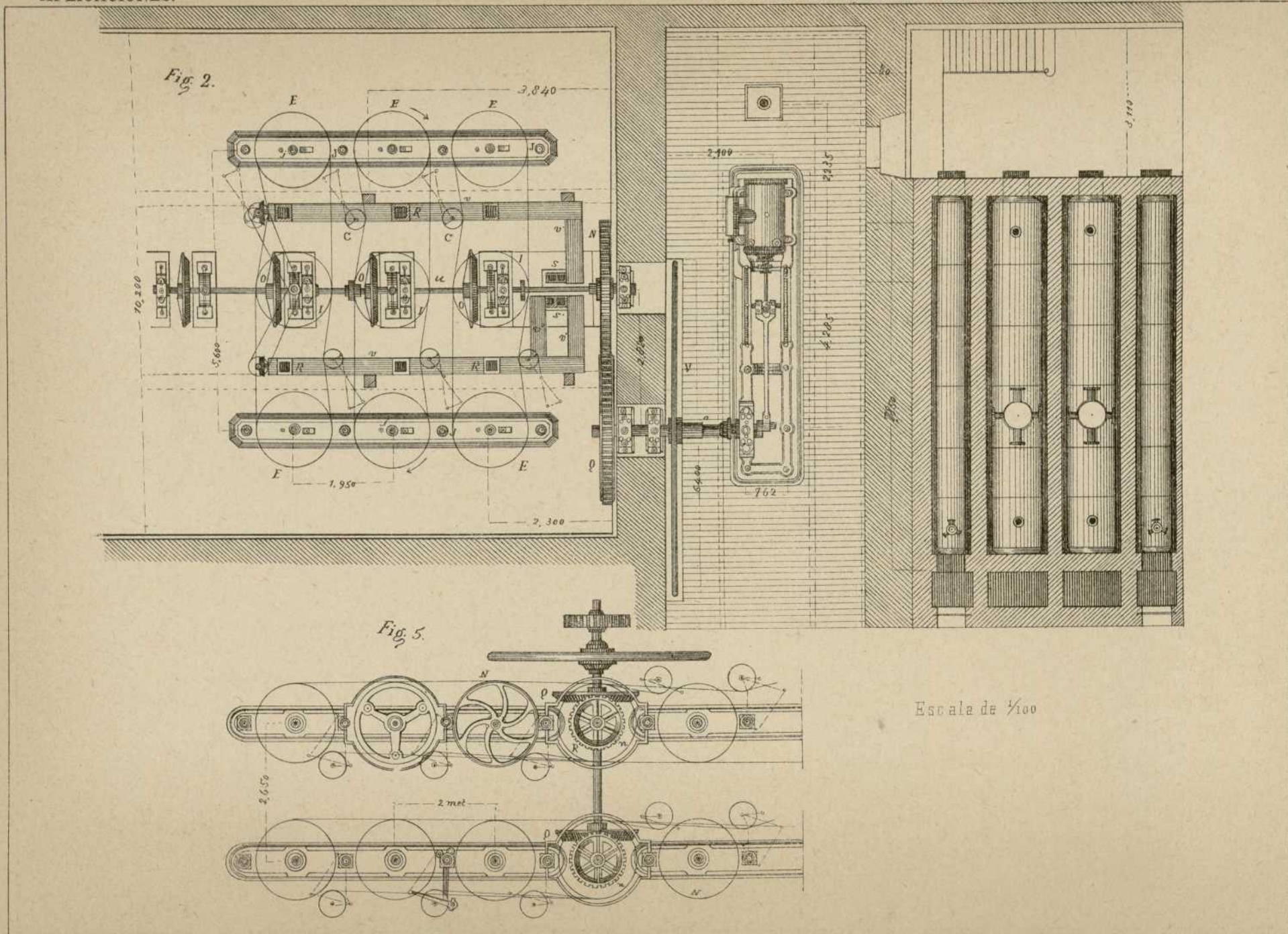


Fig. 11.

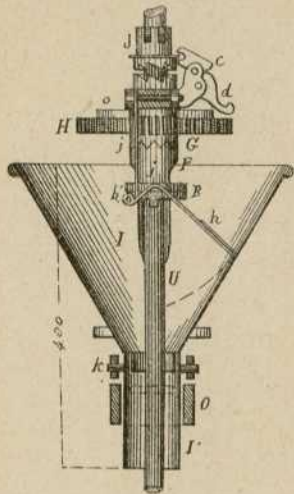


Fig. 6.

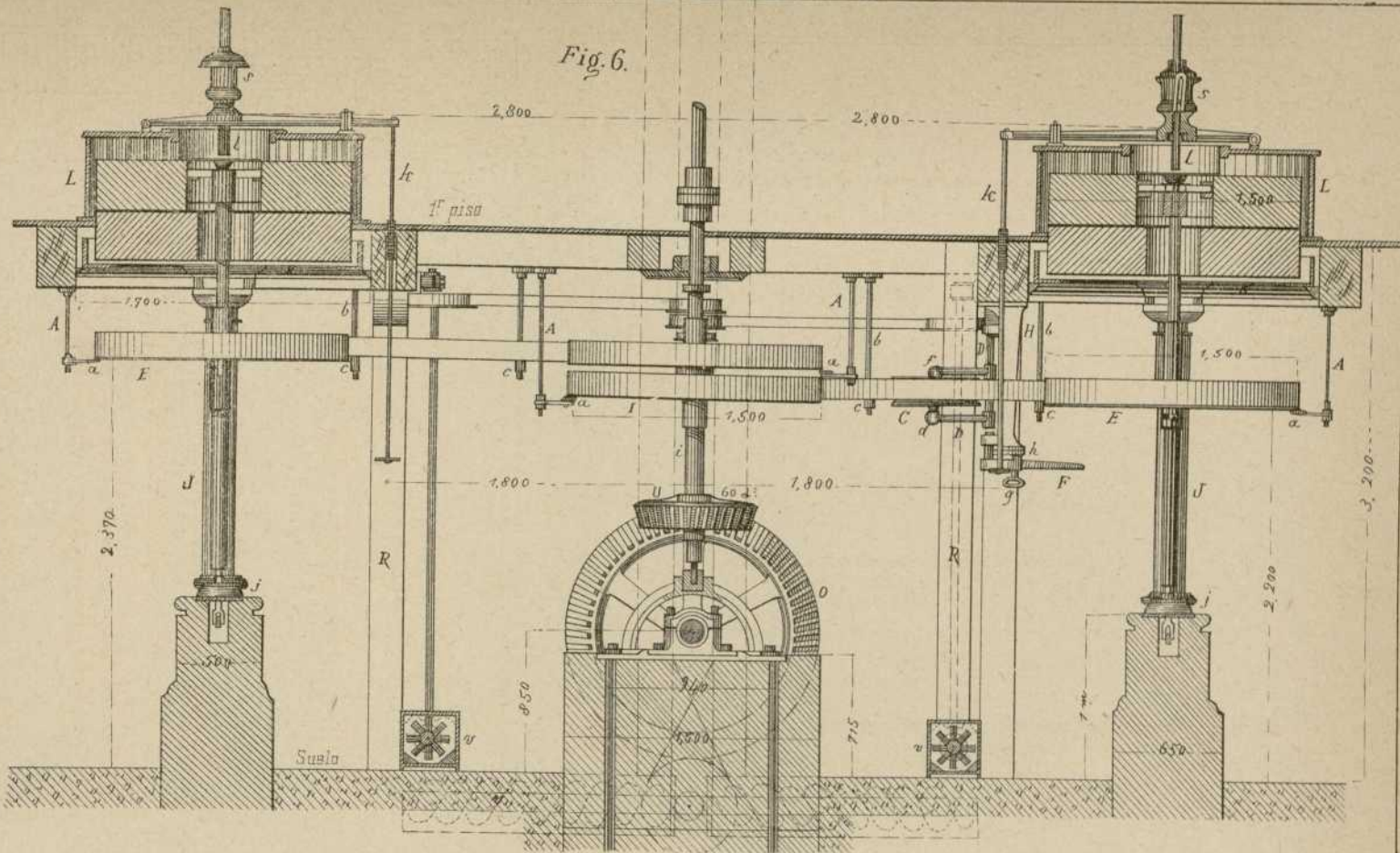


Fig. 8.

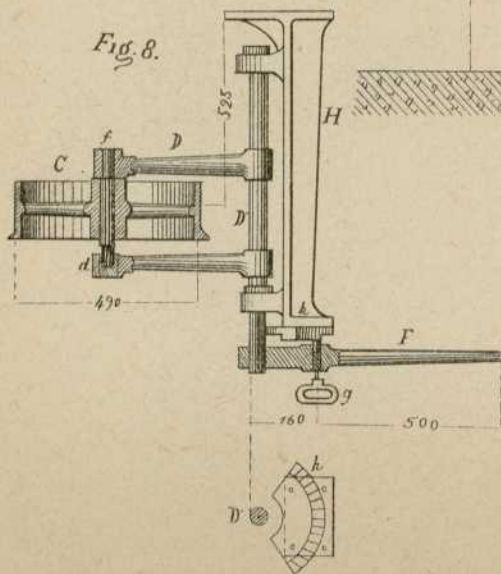


Fig. 12.

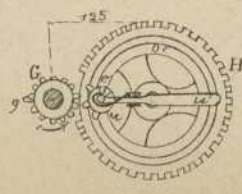


Fig. 13.

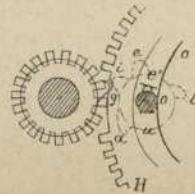
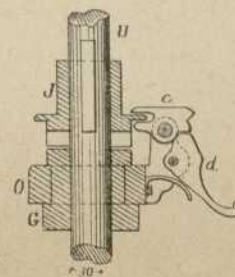
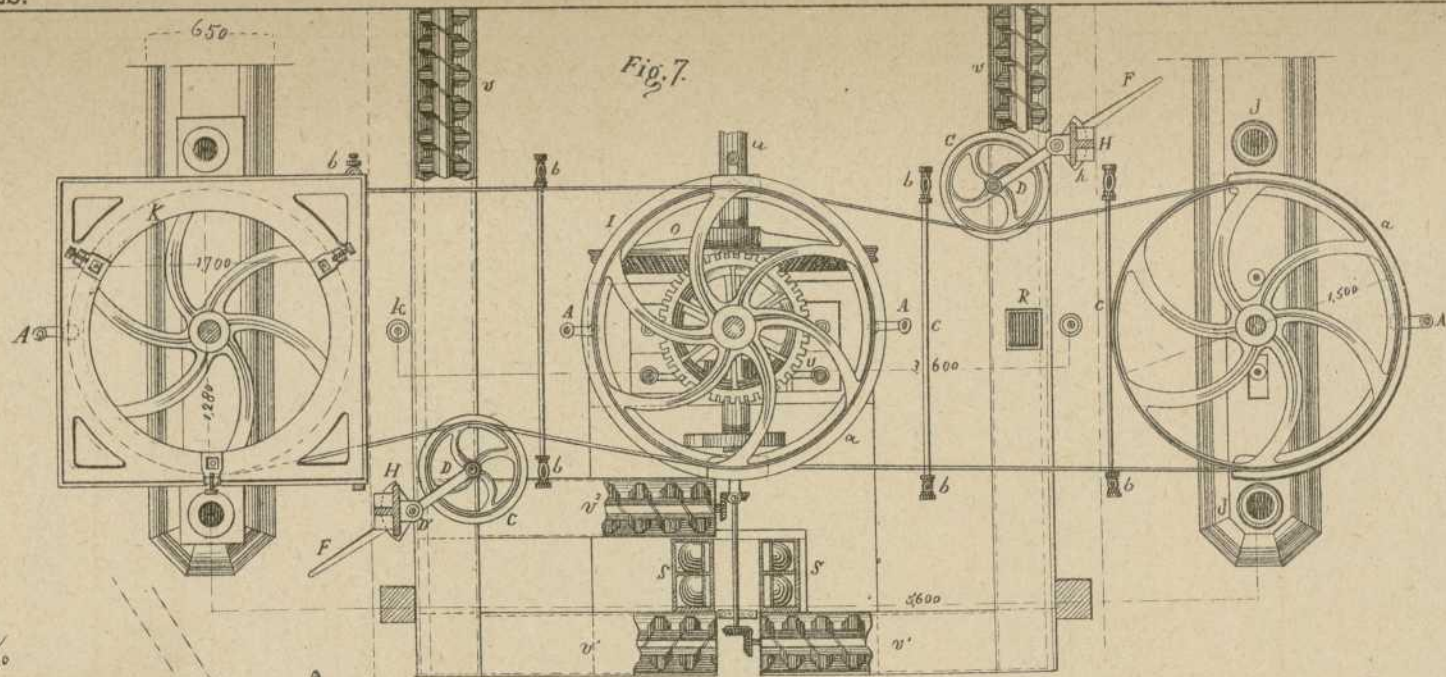


Fig. 14.

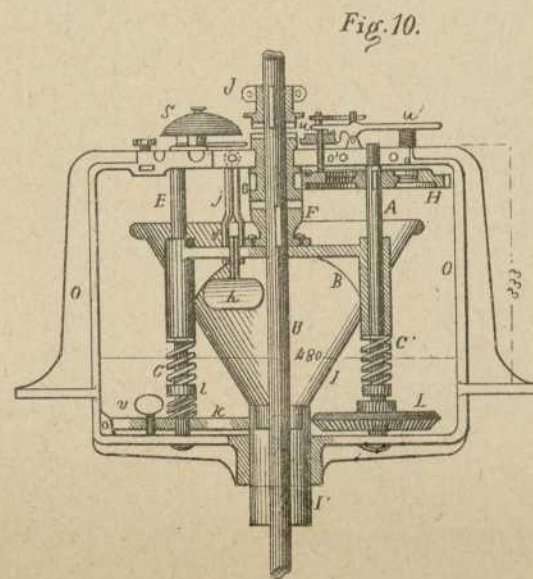
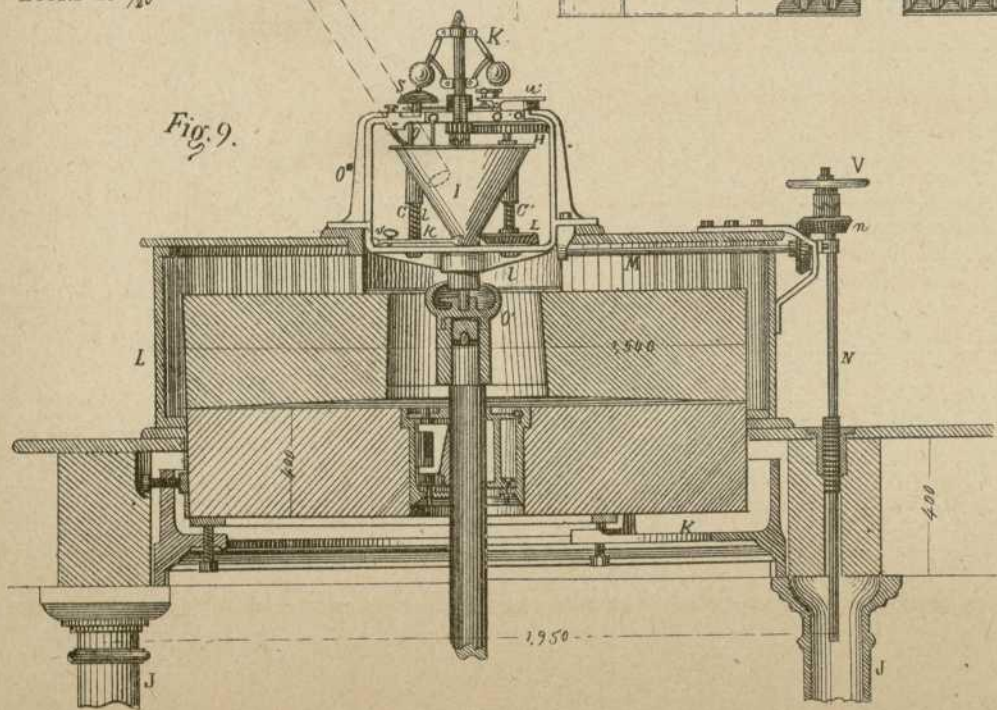


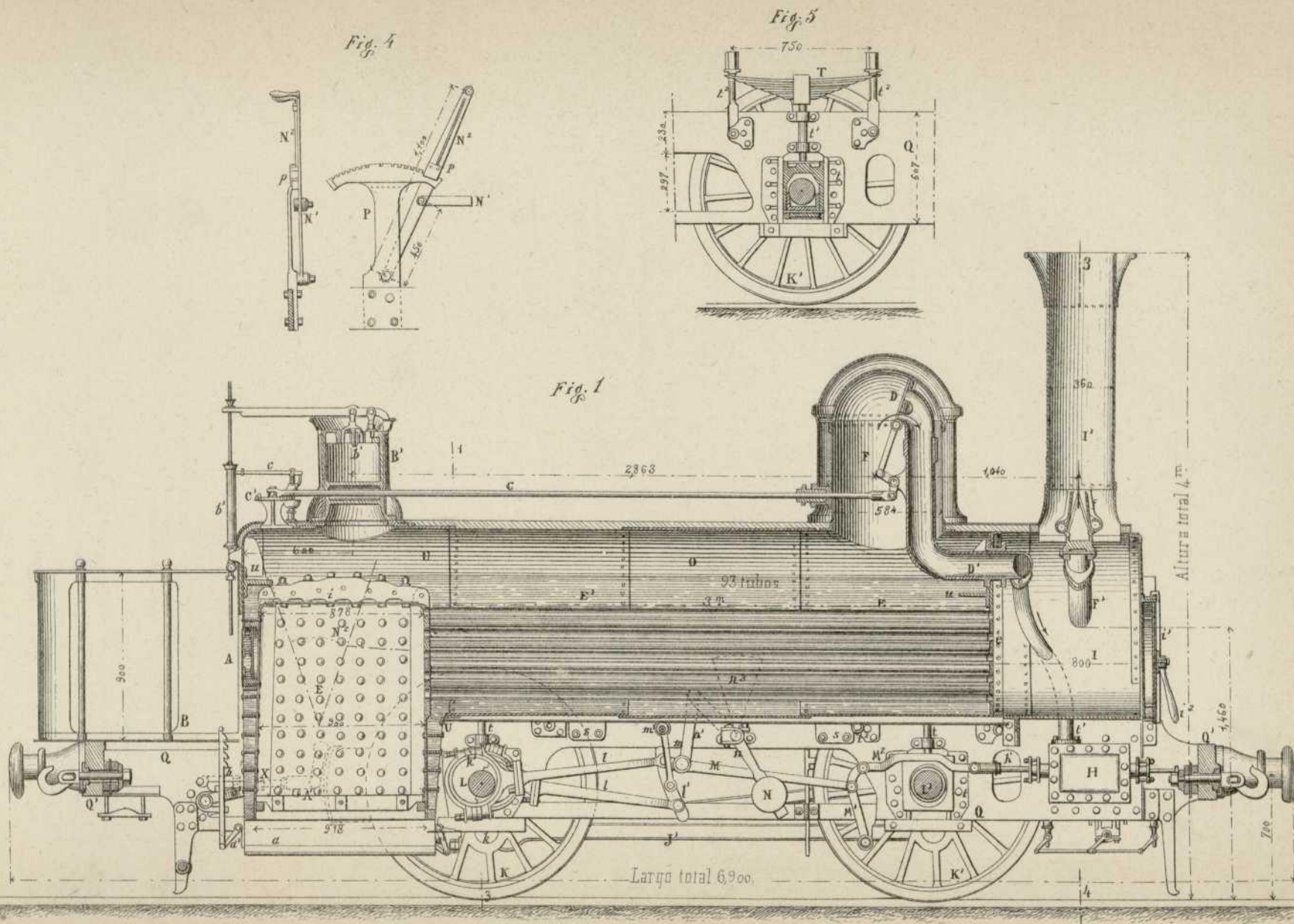
Escala de $\frac{1}{40}$ por las fig. 6 y 7
 " de $\frac{1}{60}$ por las fig. 10 a 12

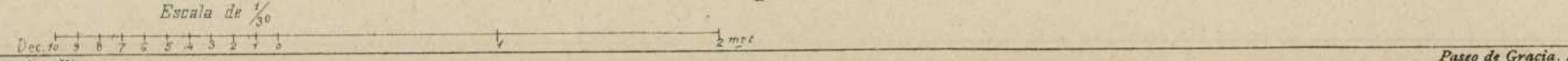
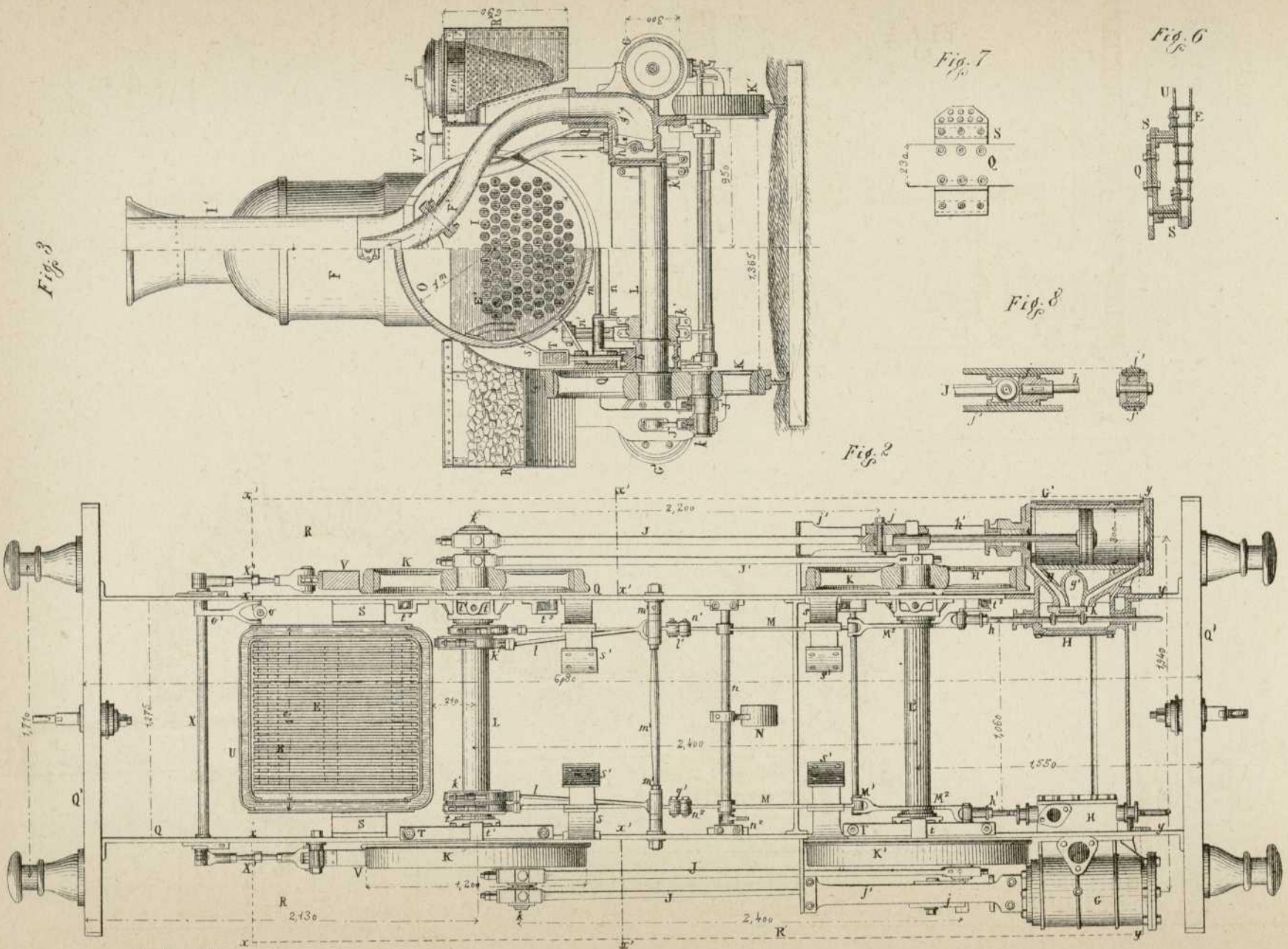
8.



Escala de $\frac{1}{40}$

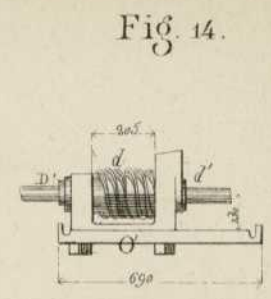
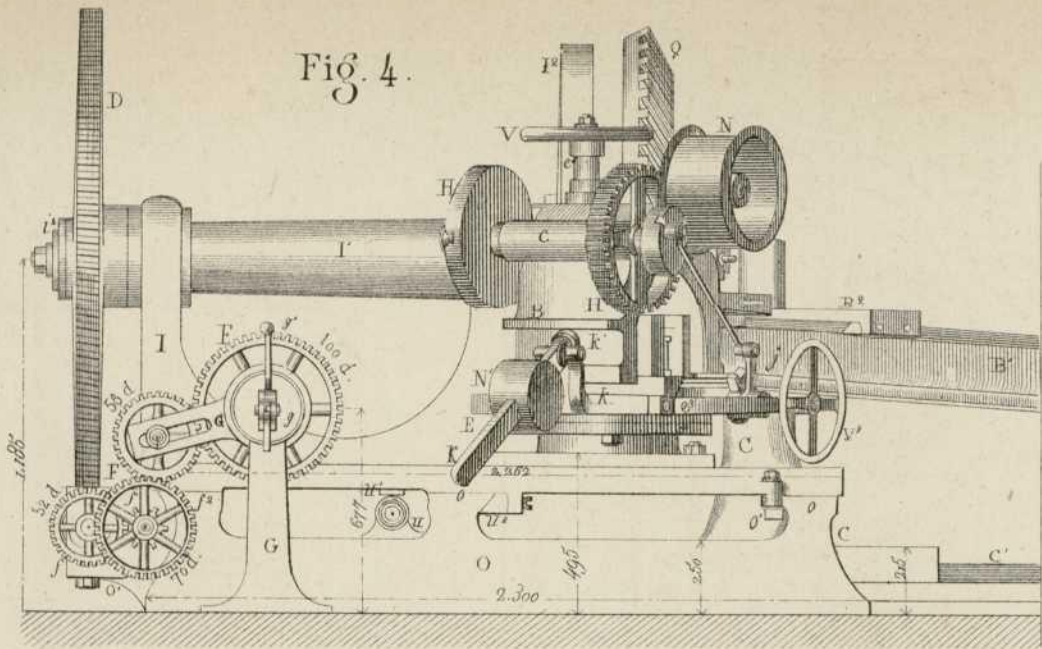






Nacents, editor.

Passo de Gracia. 149.



Escala de 1/45
 Déc 10 9 8 7 6 5 4 3 2 1 0 1 2 metros.

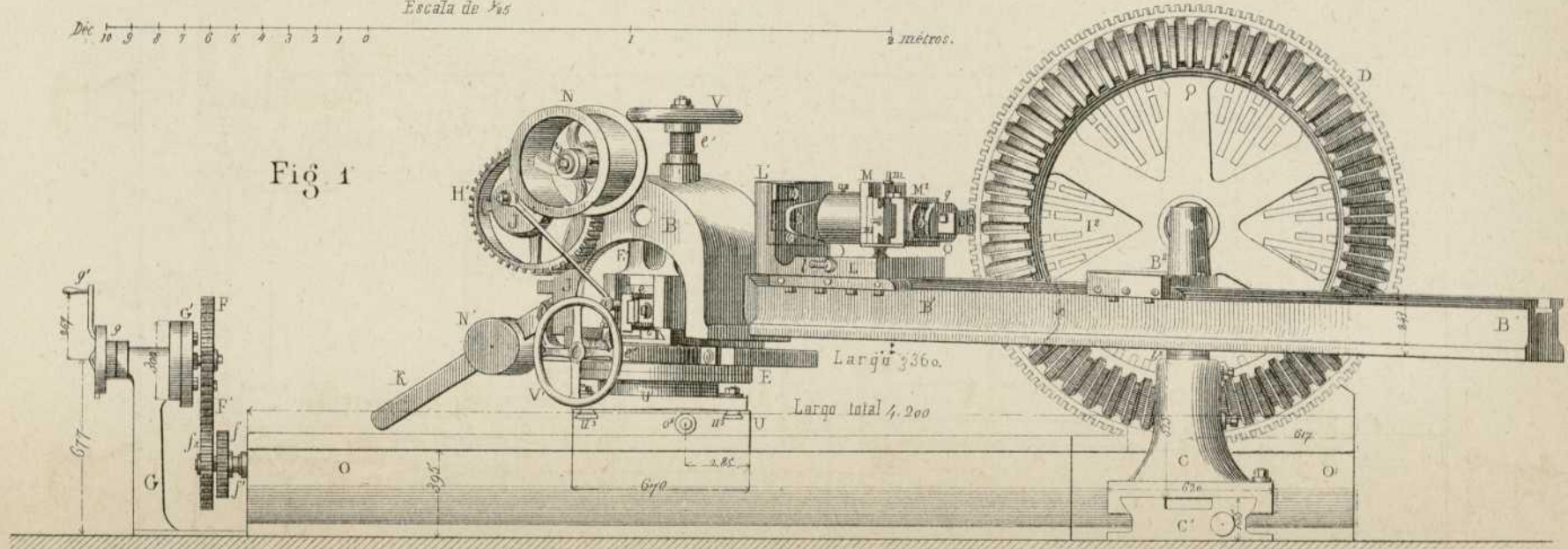


Fig. 5.

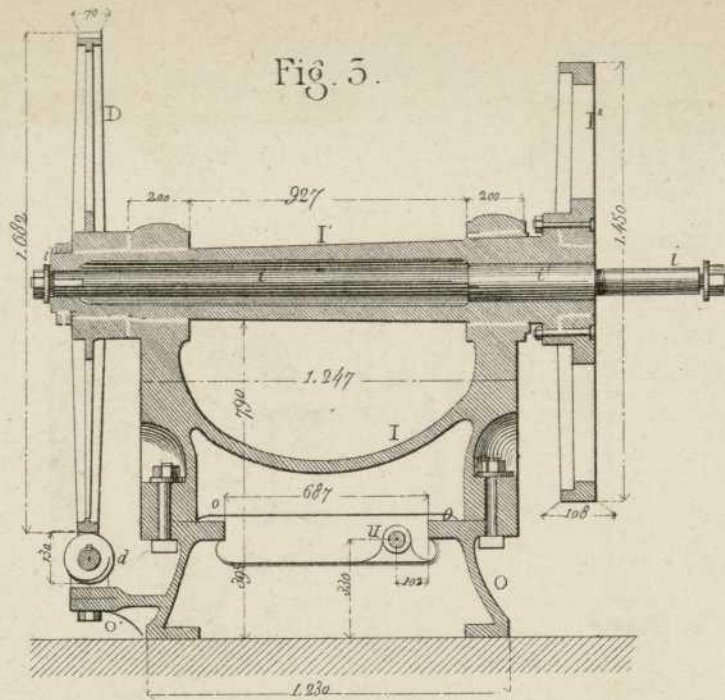
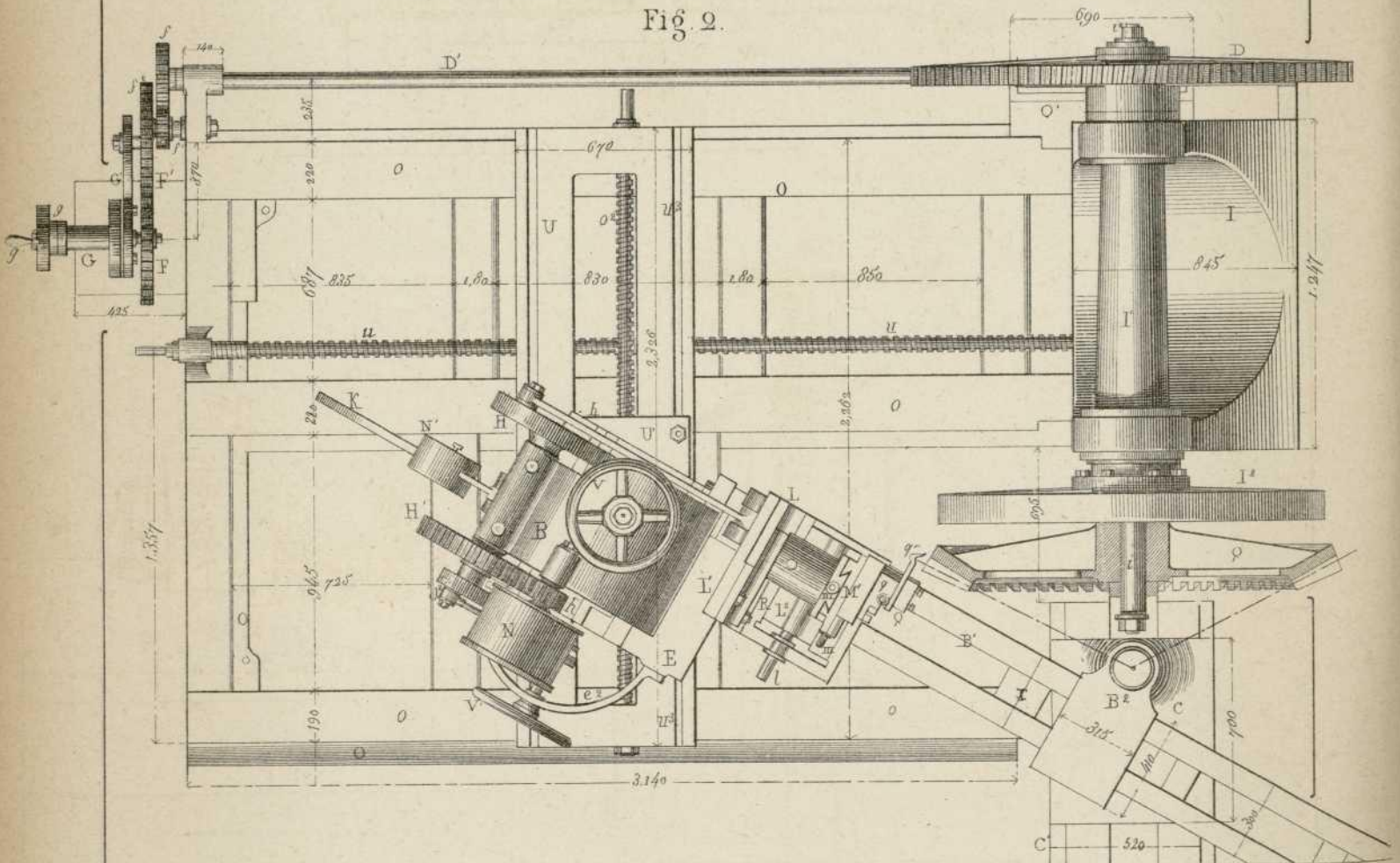


Fig. 6.



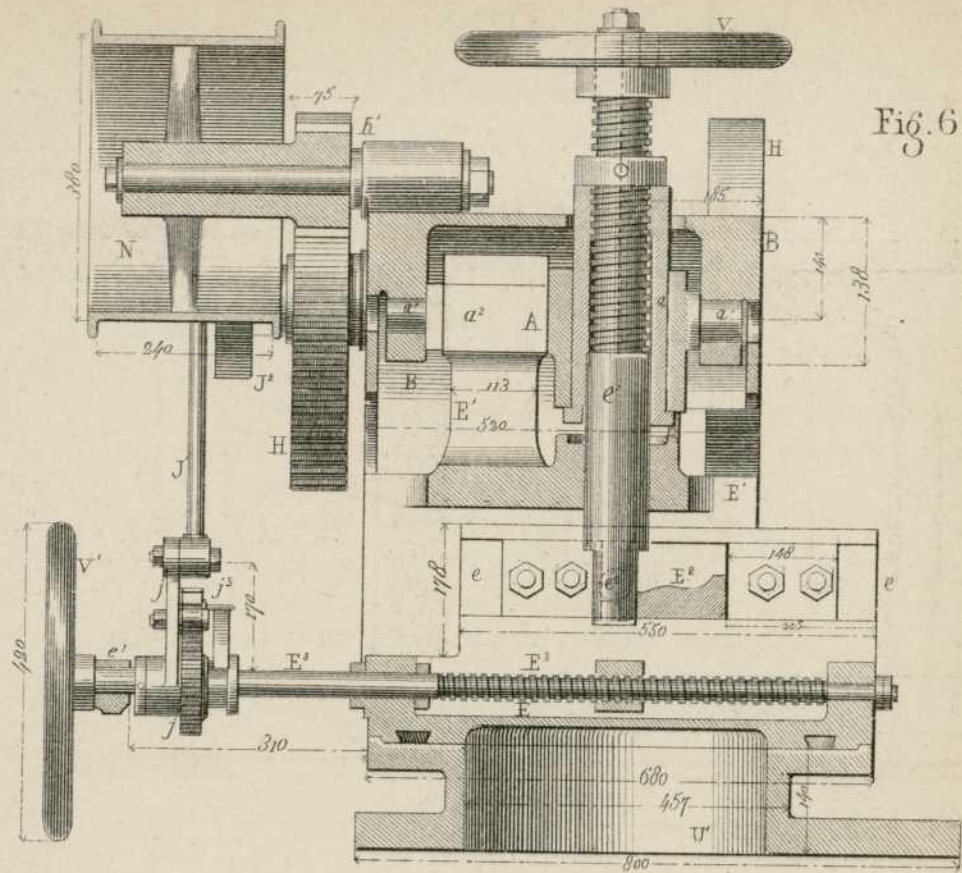


Fig. 6.

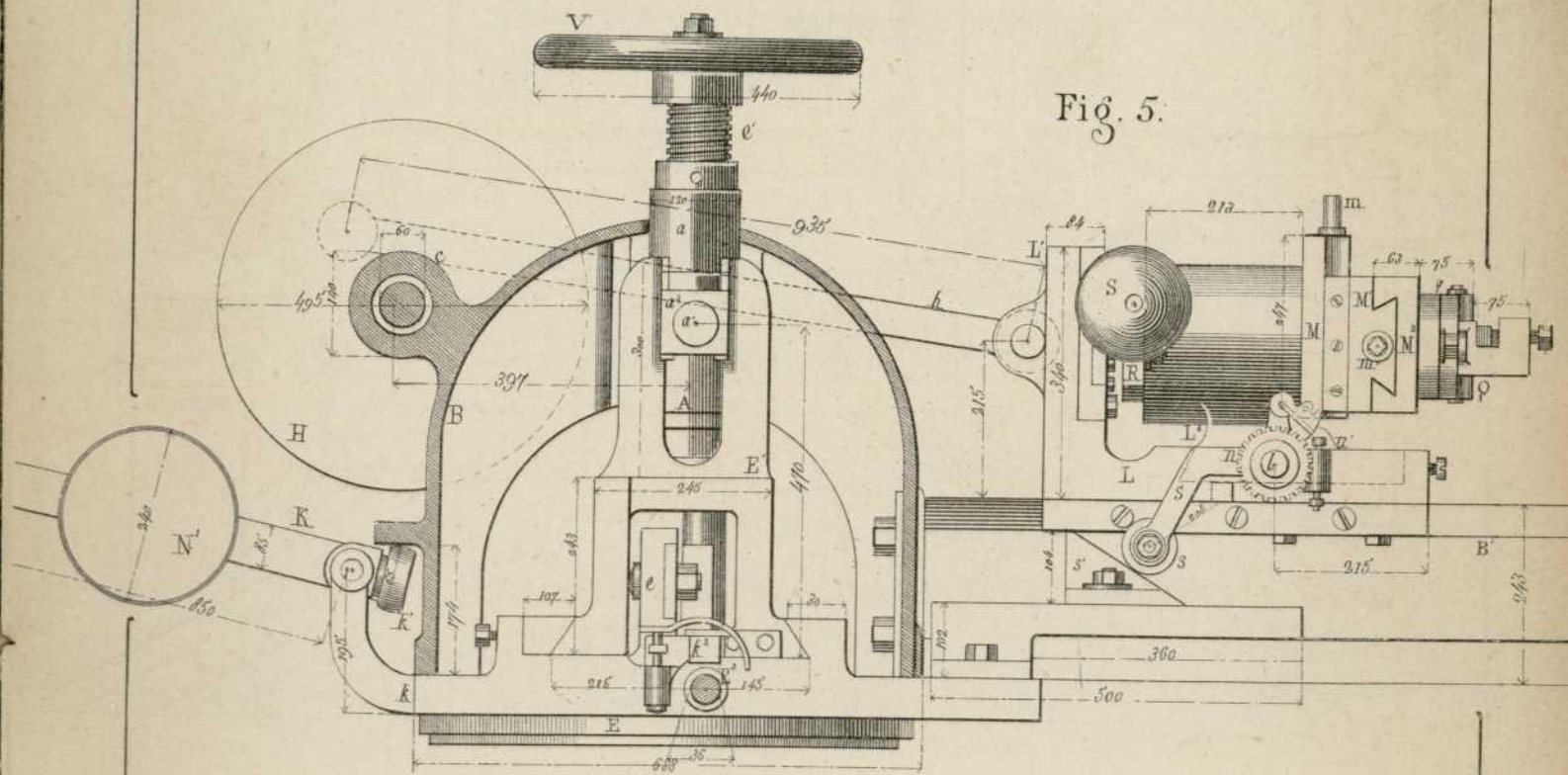


Fig. 5.

Fig. 7.

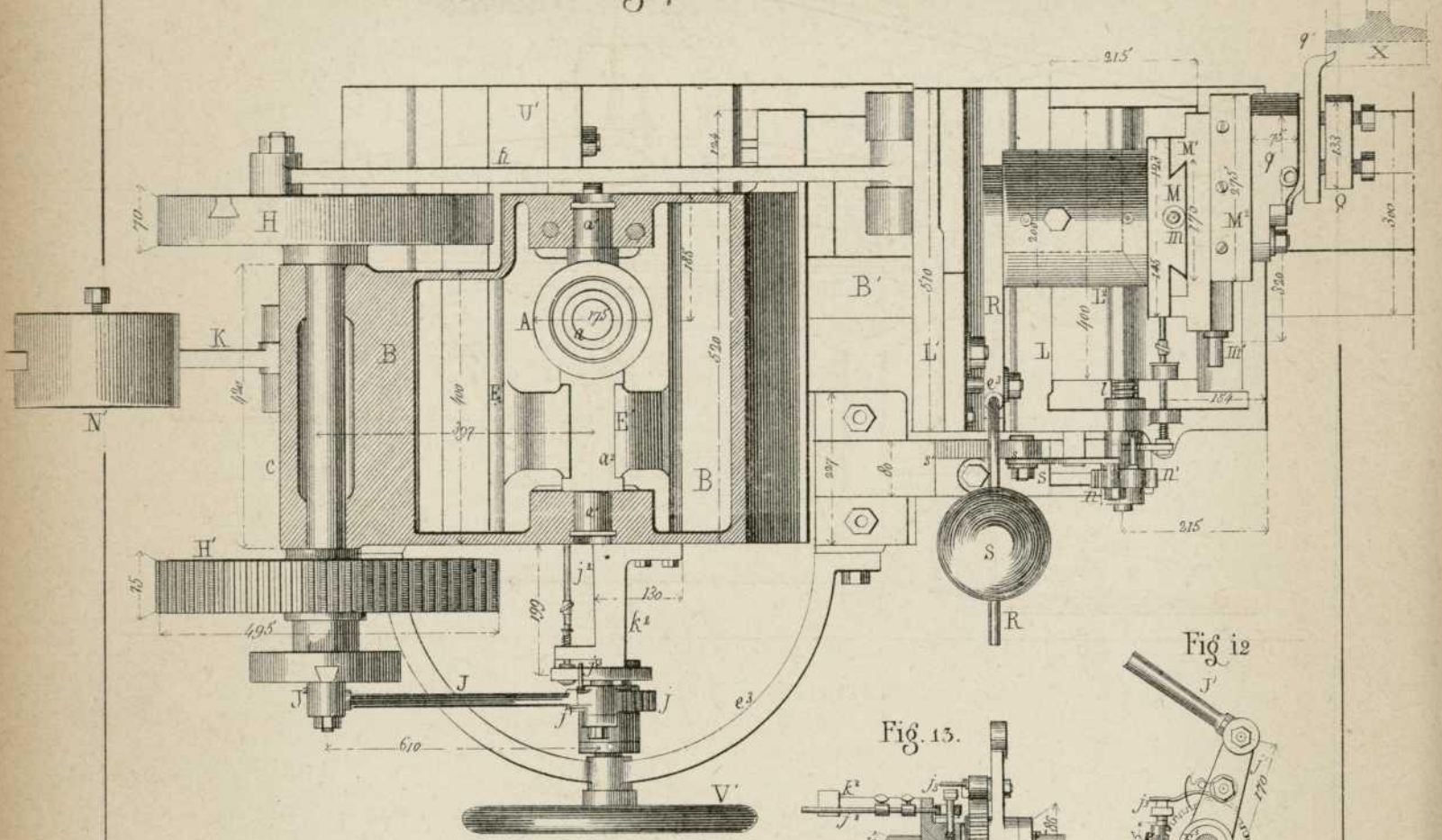


Fig. 12.

Fig. 15.

Fig. 9.

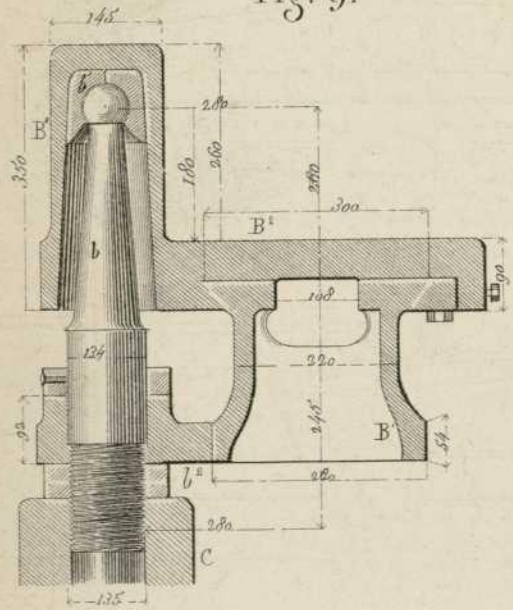


Fig. 8.

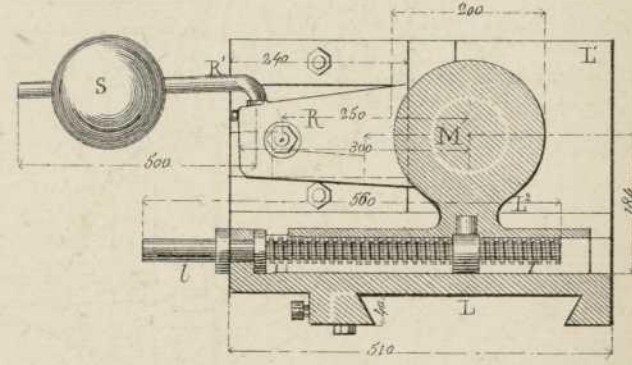
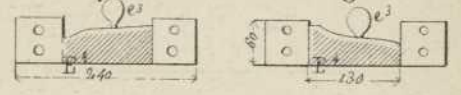
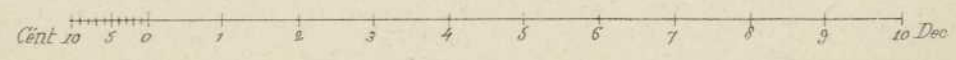


Fig. 10.

Fig. 11.



Escala de 1/10



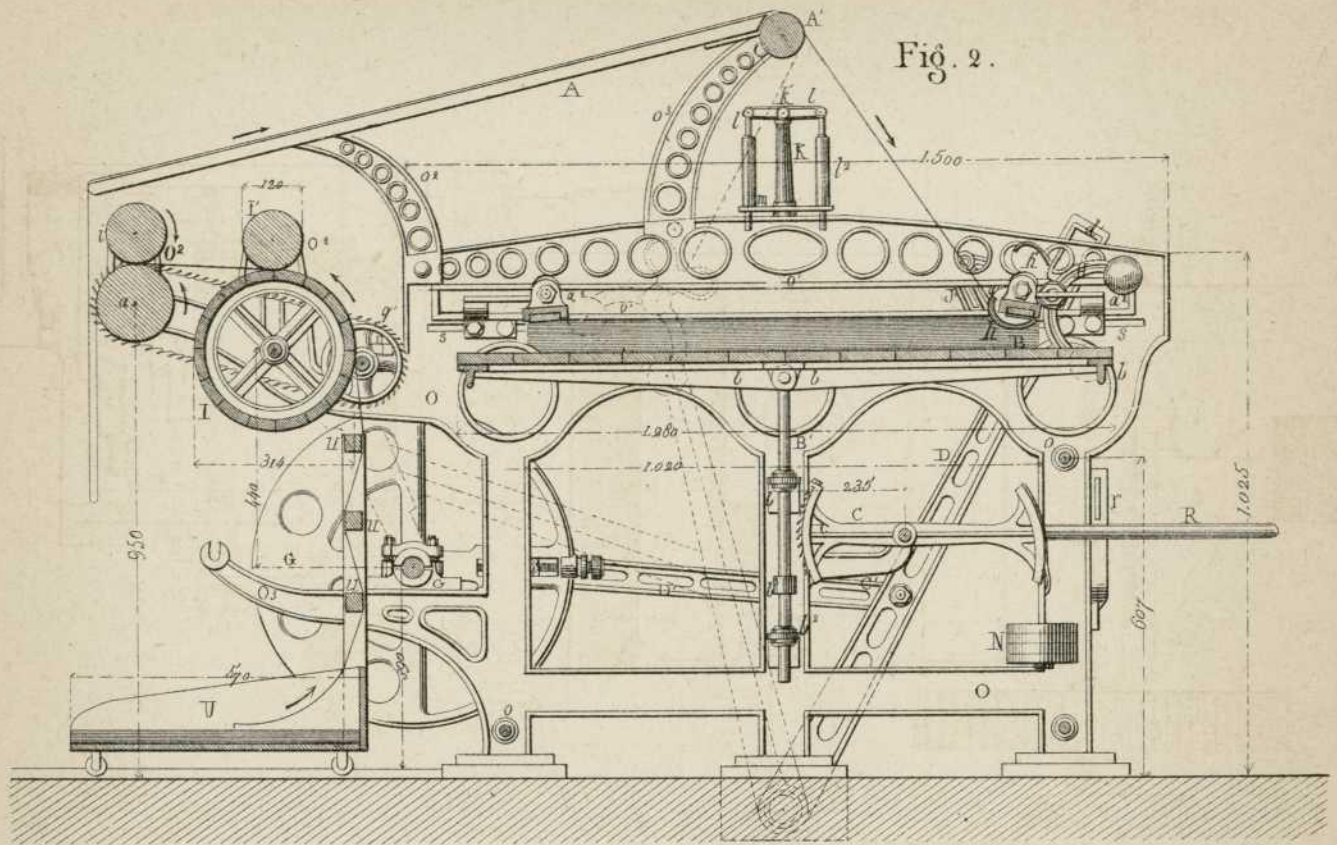


Fig. 2.

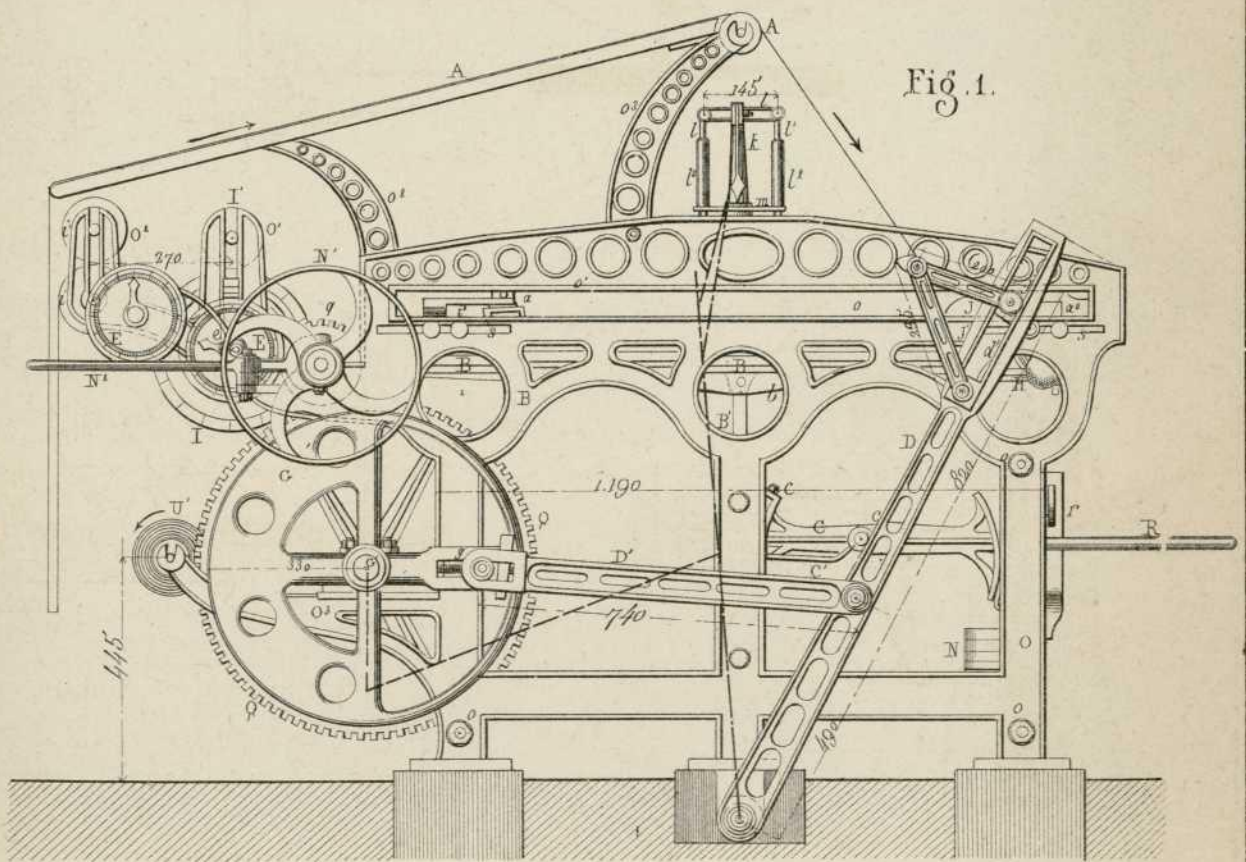


Fig. 1.

Fig. 4.

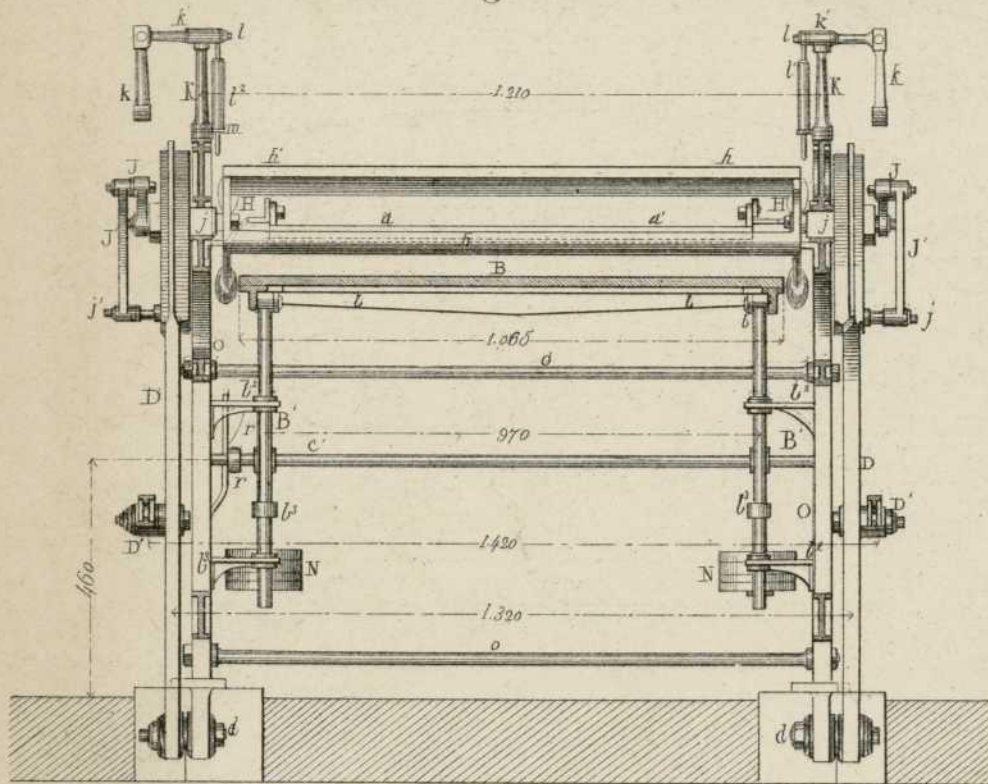


Fig. 5.

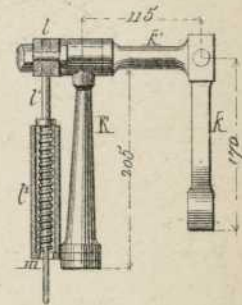
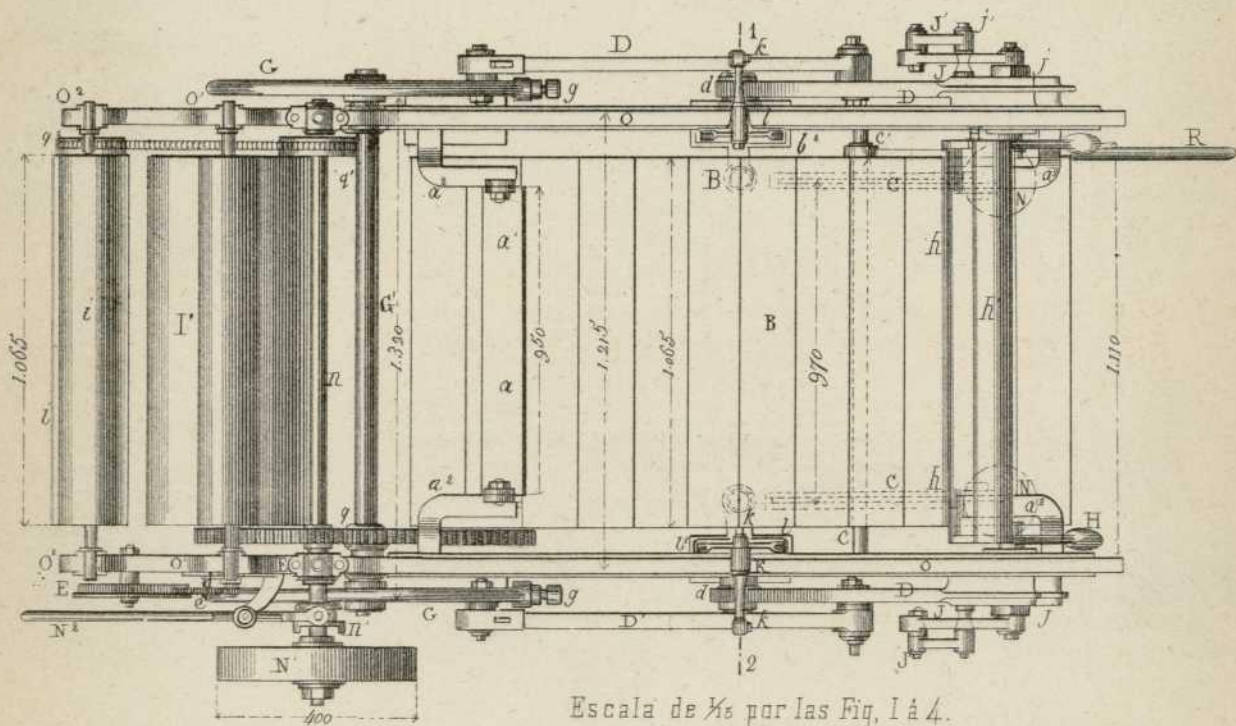


Fig. 3.



Escala de $\frac{1}{16}$ por las Fig. 1 á 4.

N.M.

Fig. 1.

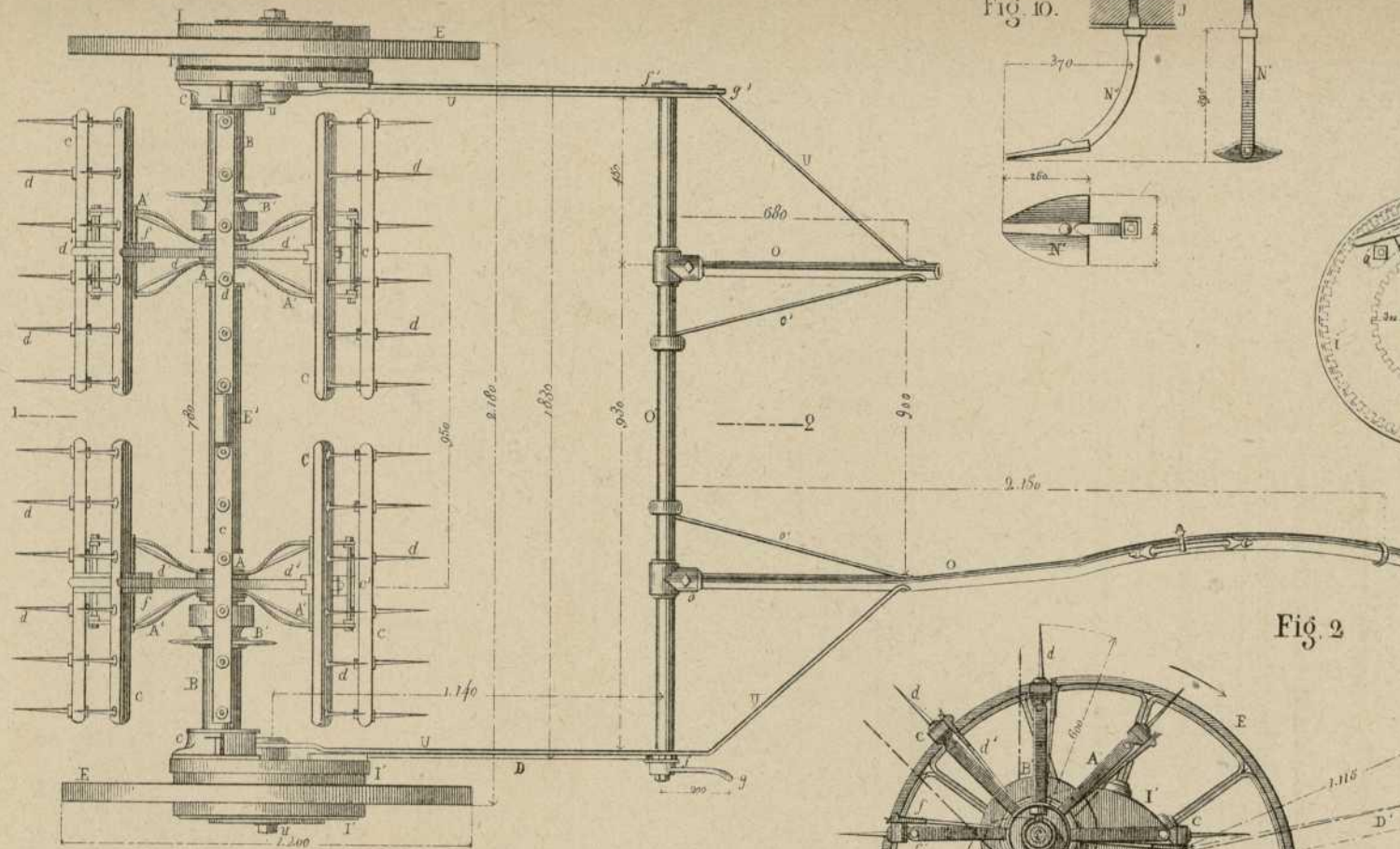


Fig. 10.

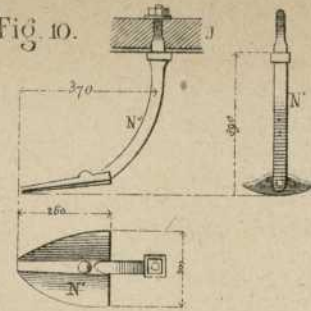


Fig. 4.

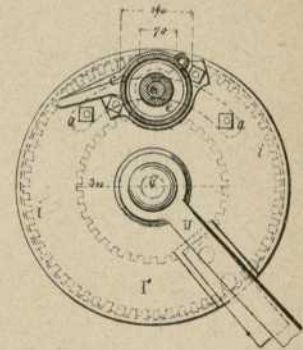


Fig. 2.

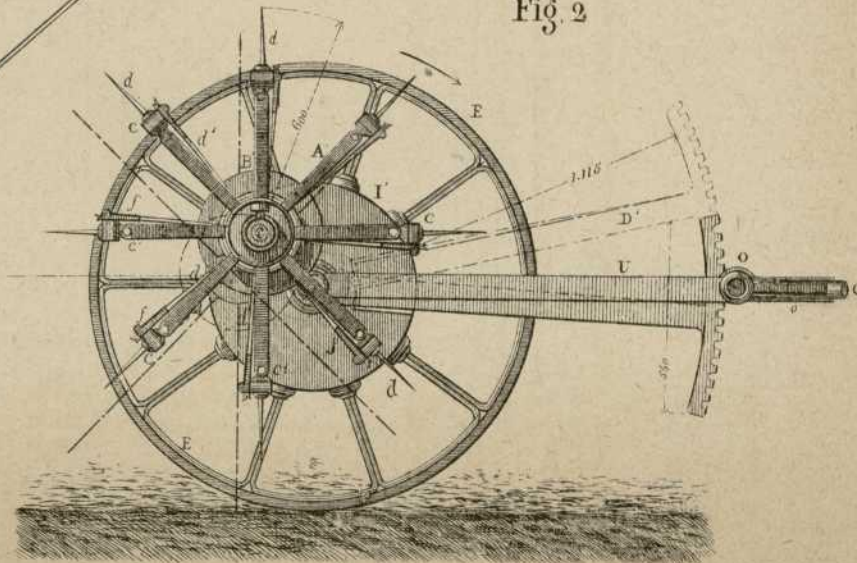


Fig. 5.

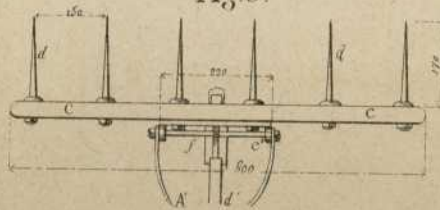
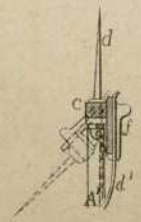
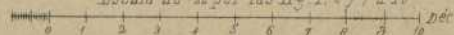


Fig. 6.



Escala de 1/20 por las Fig. 1. a 77 a 10



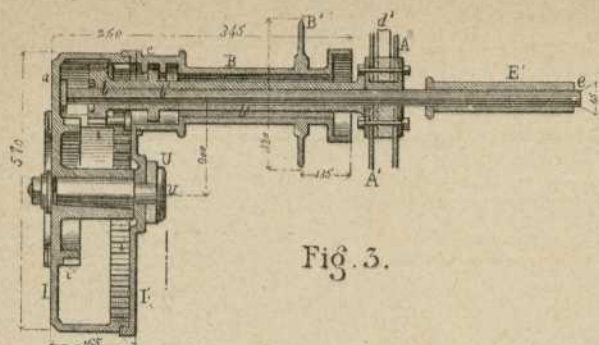


Fig. 3.

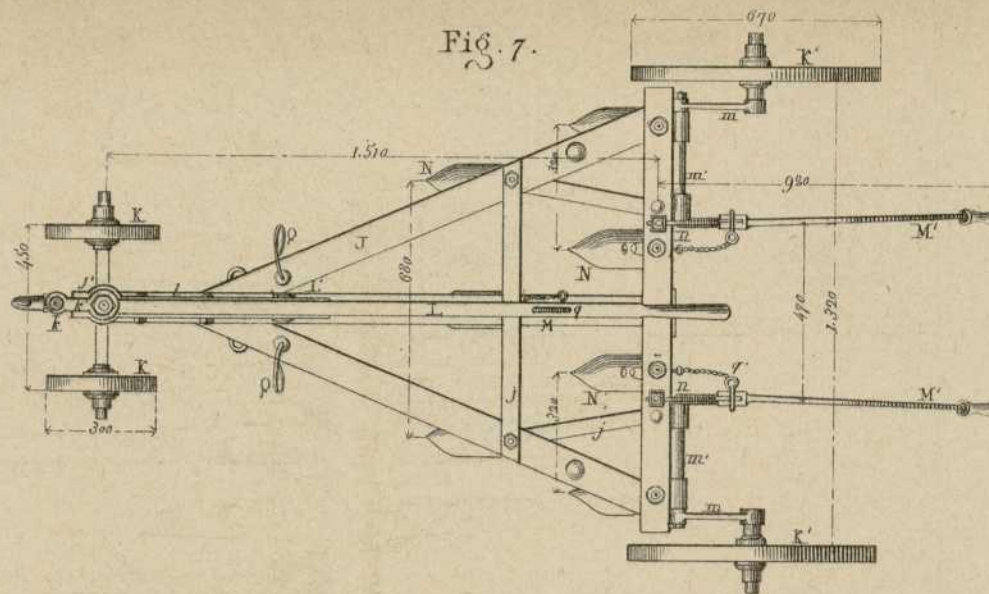


Fig. 7.

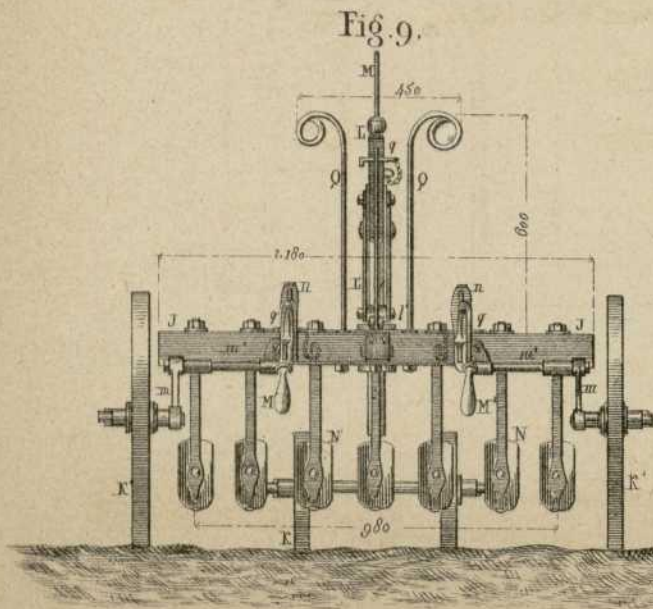


Fig. 9.

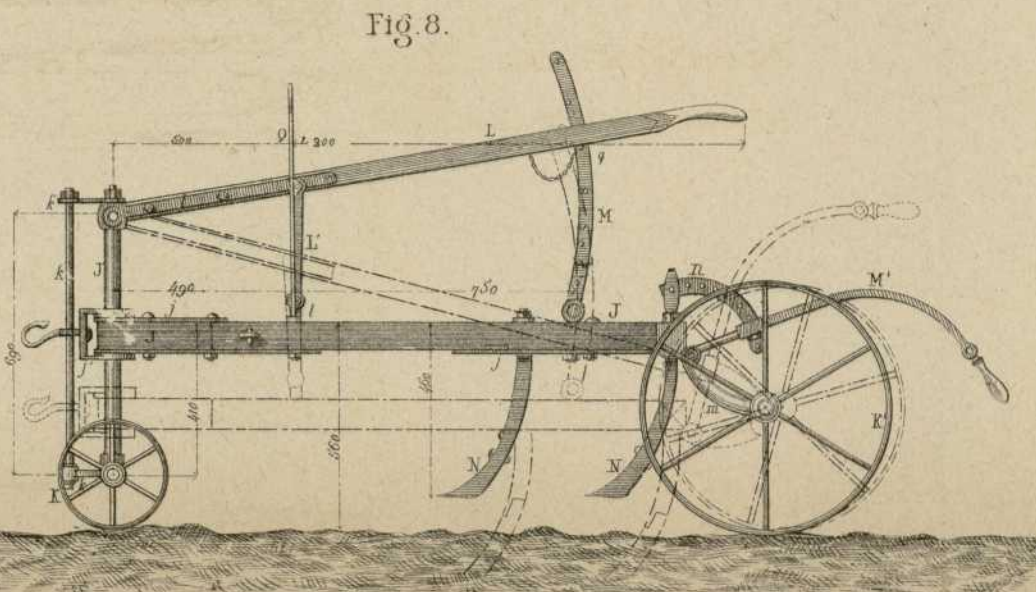
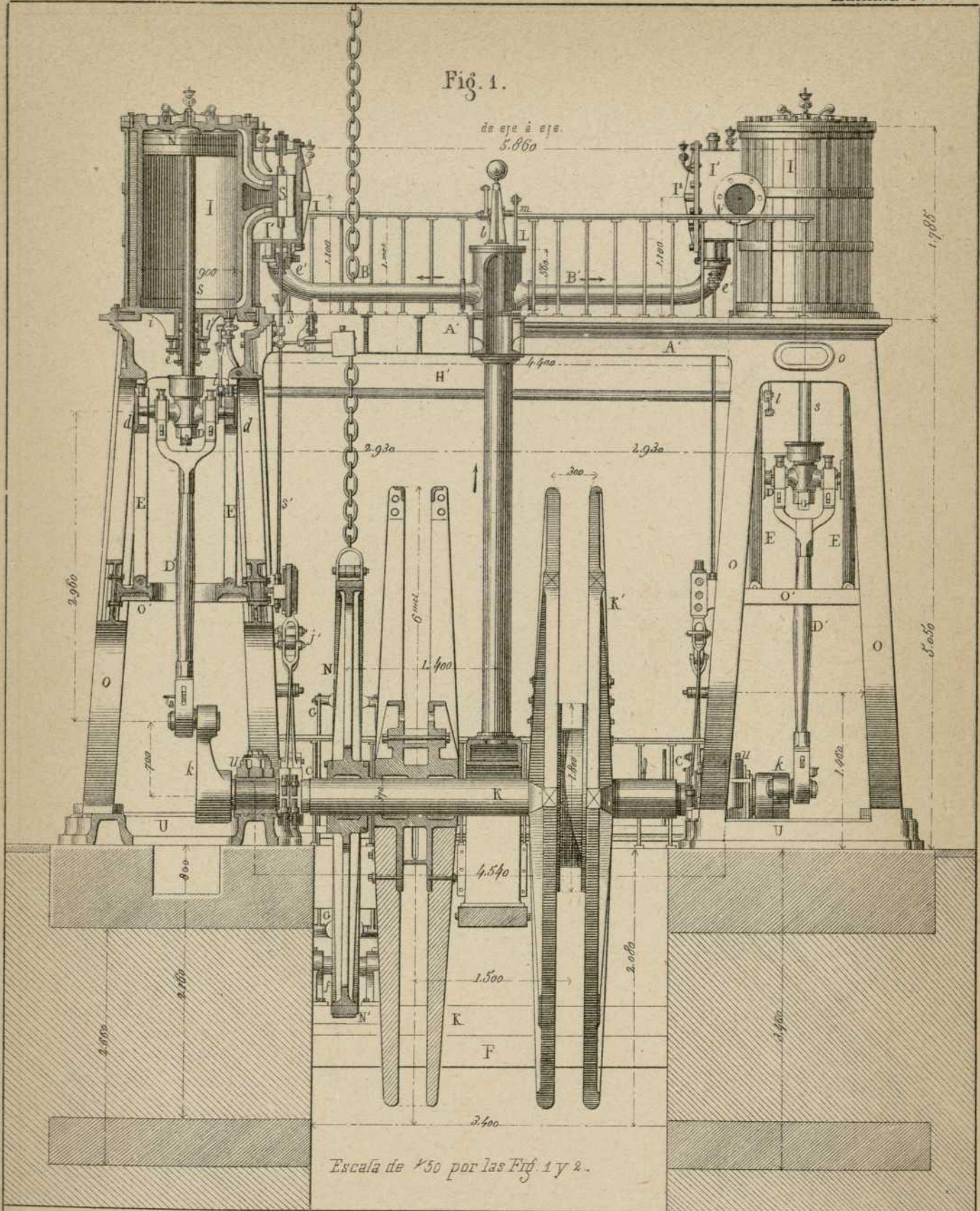


Fig. 8.

Escala de $\frac{1}{5}$ por las fig. 3 á 6.

Fig. 1.



Escala de 1/50 por las Fig. 1 y 2.

Fig. 2.

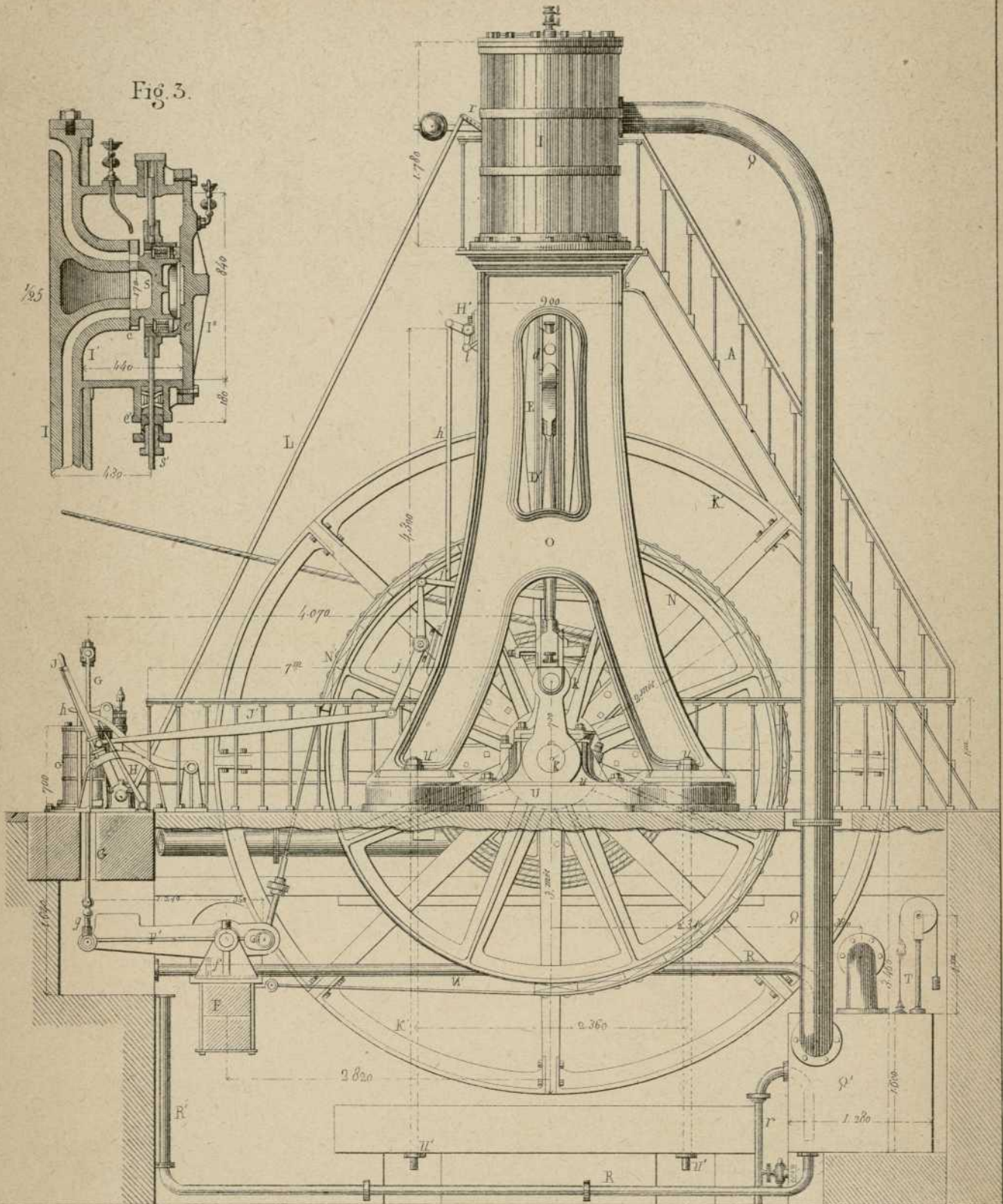


Fig. 5.

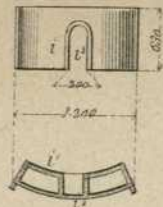


Fig. 2.

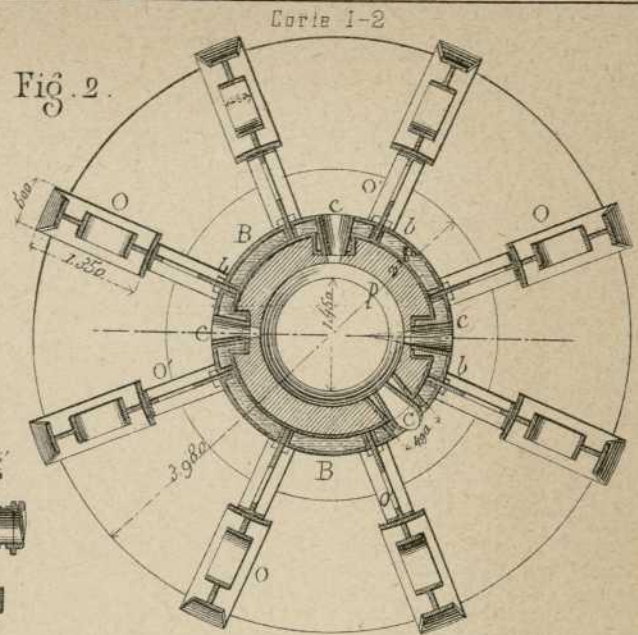
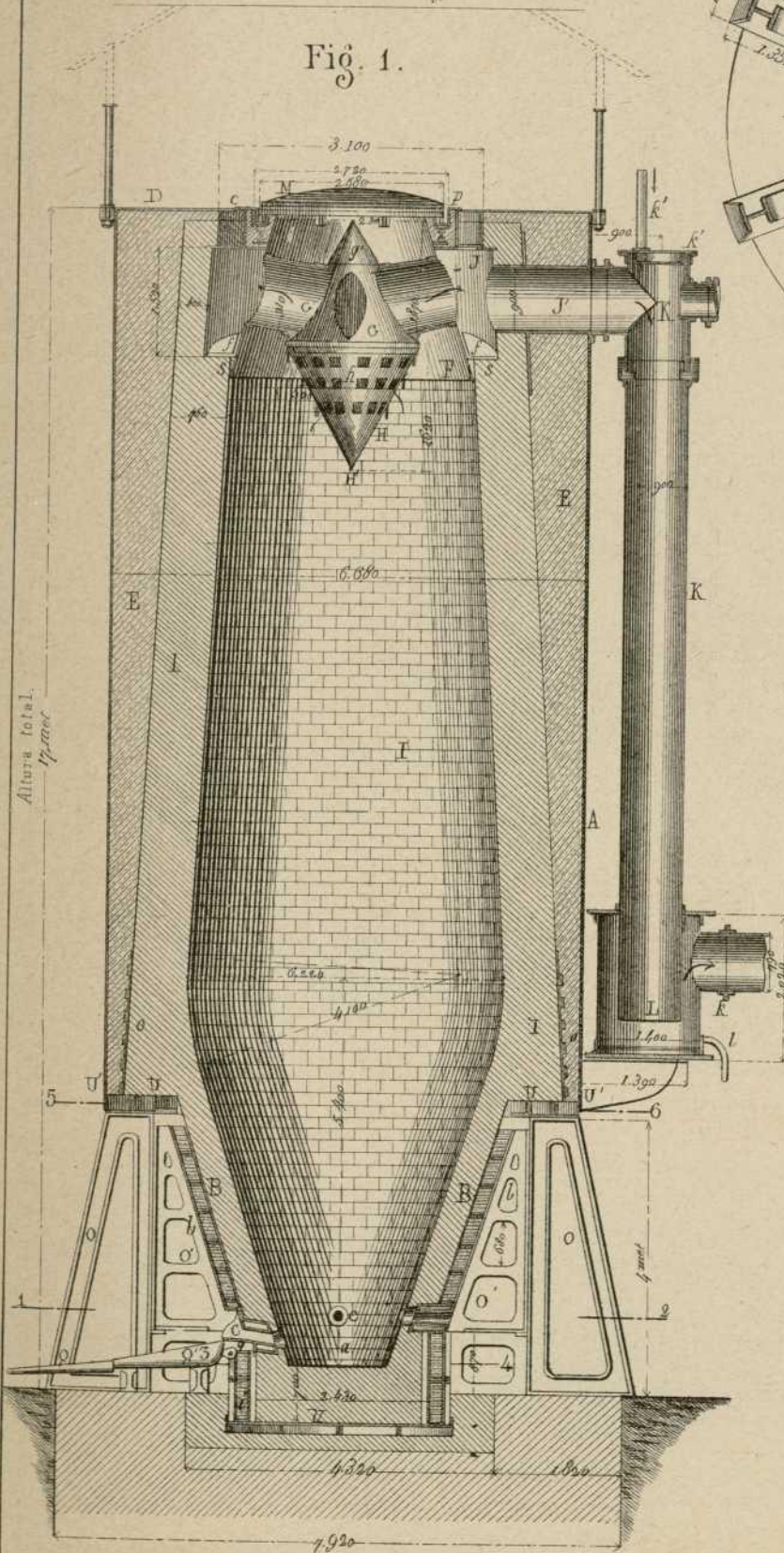
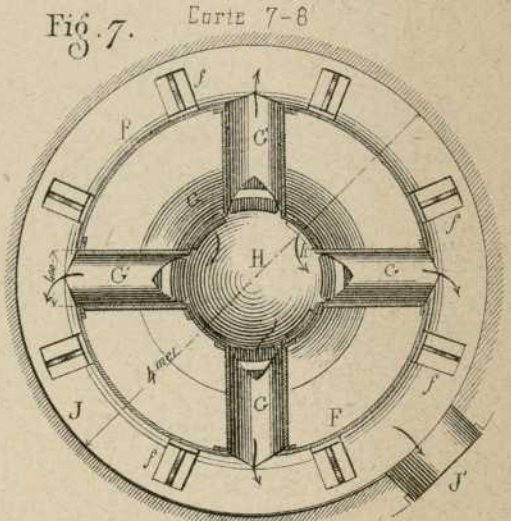


Fig. 1.



Altura total.
17.000

Fig. 7.



Corte por 5-6

Fig. 11.

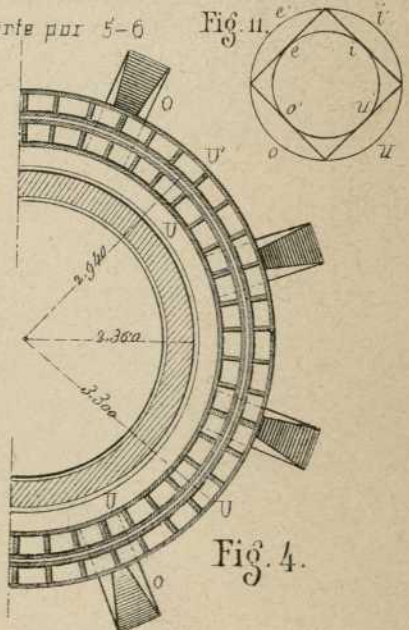


Fig. 4.

Fig. 8.

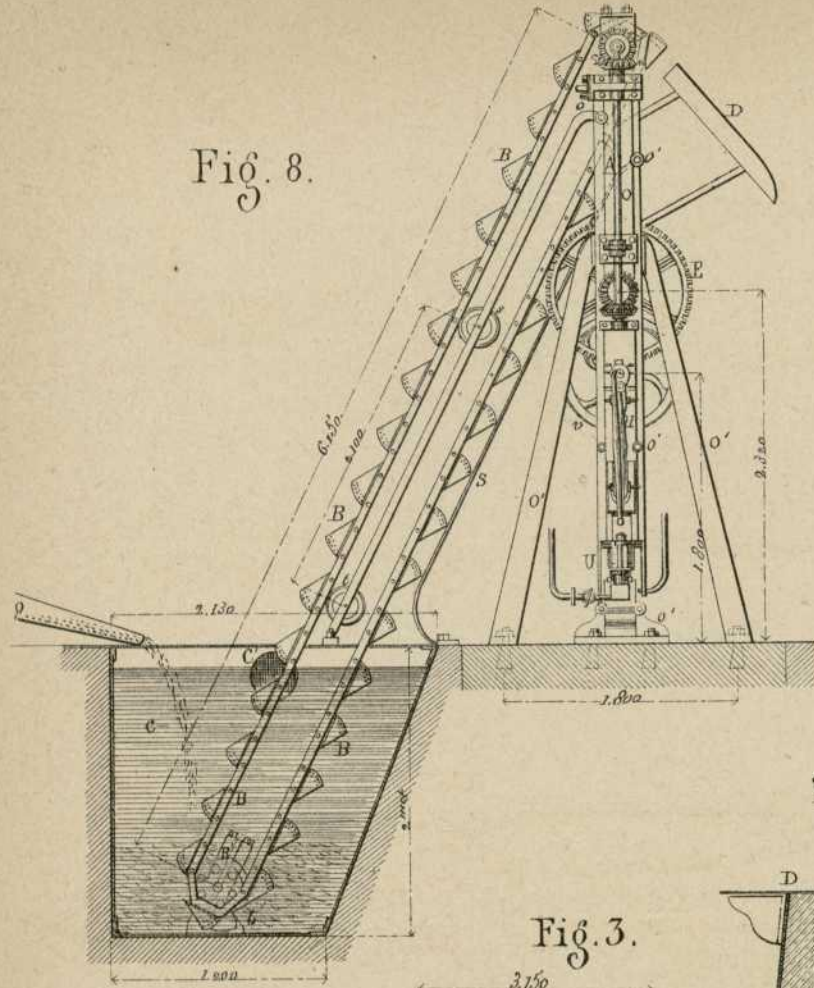


Fig. 9.

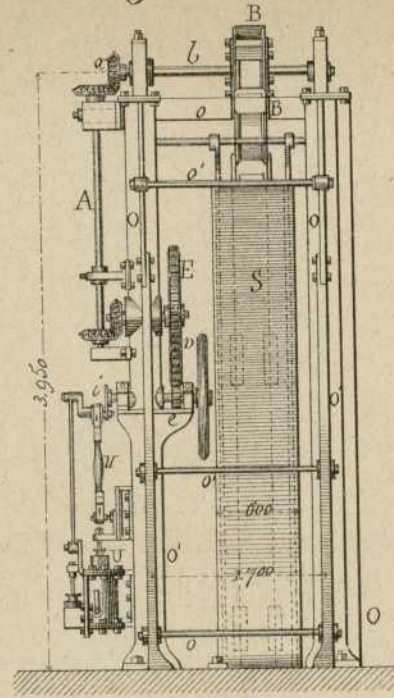


Fig. 10.

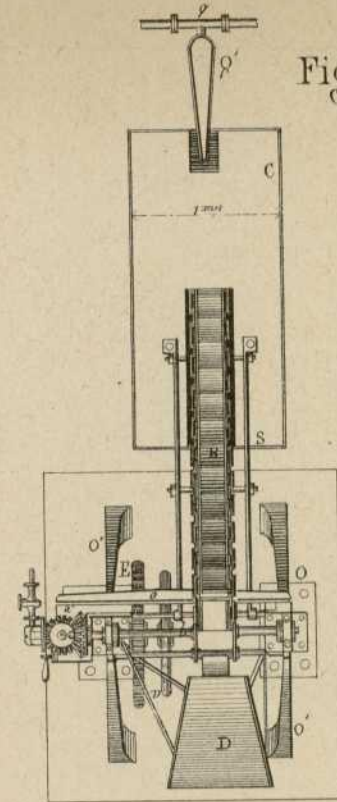
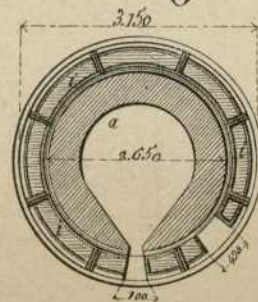


Fig. 3.

Corta por la linea 3-4



Escala de $\frac{1}{100}$ por las Fig. 1 a 5.
Escala de $\frac{1}{70}$ por las Fig. 6 y 7.
Escala de $\frac{1}{50}$ por las Fig. 8 a 10.

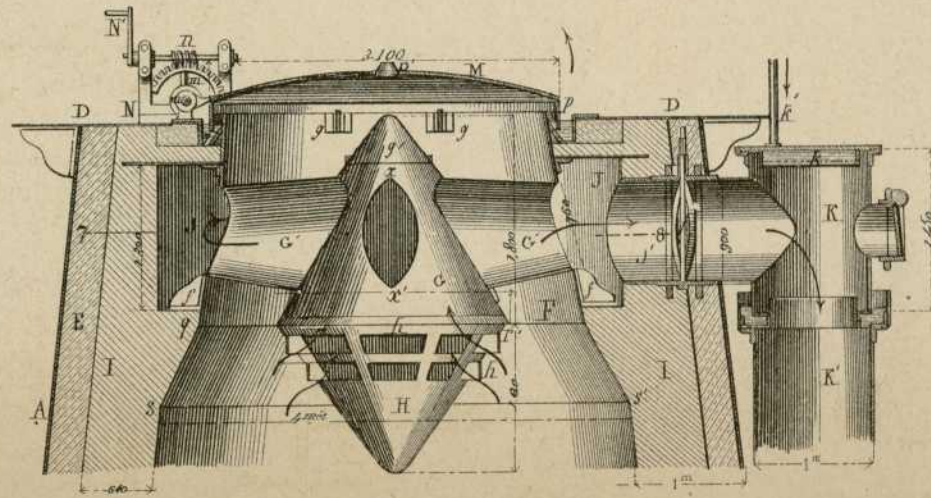
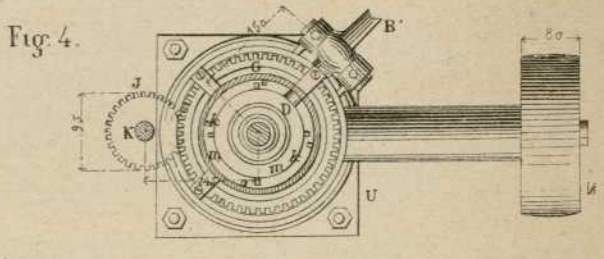
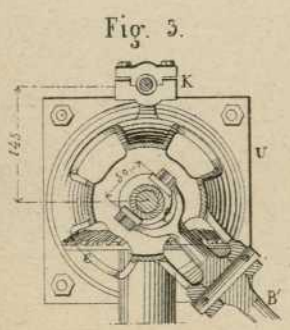
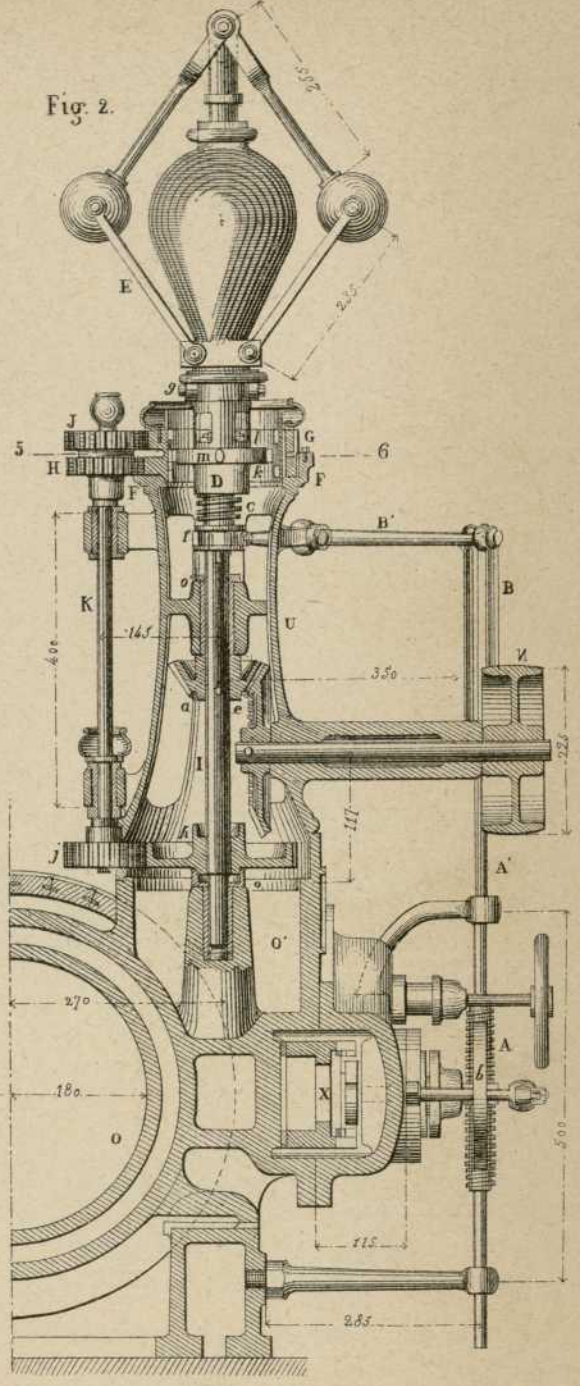
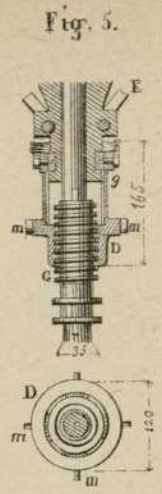
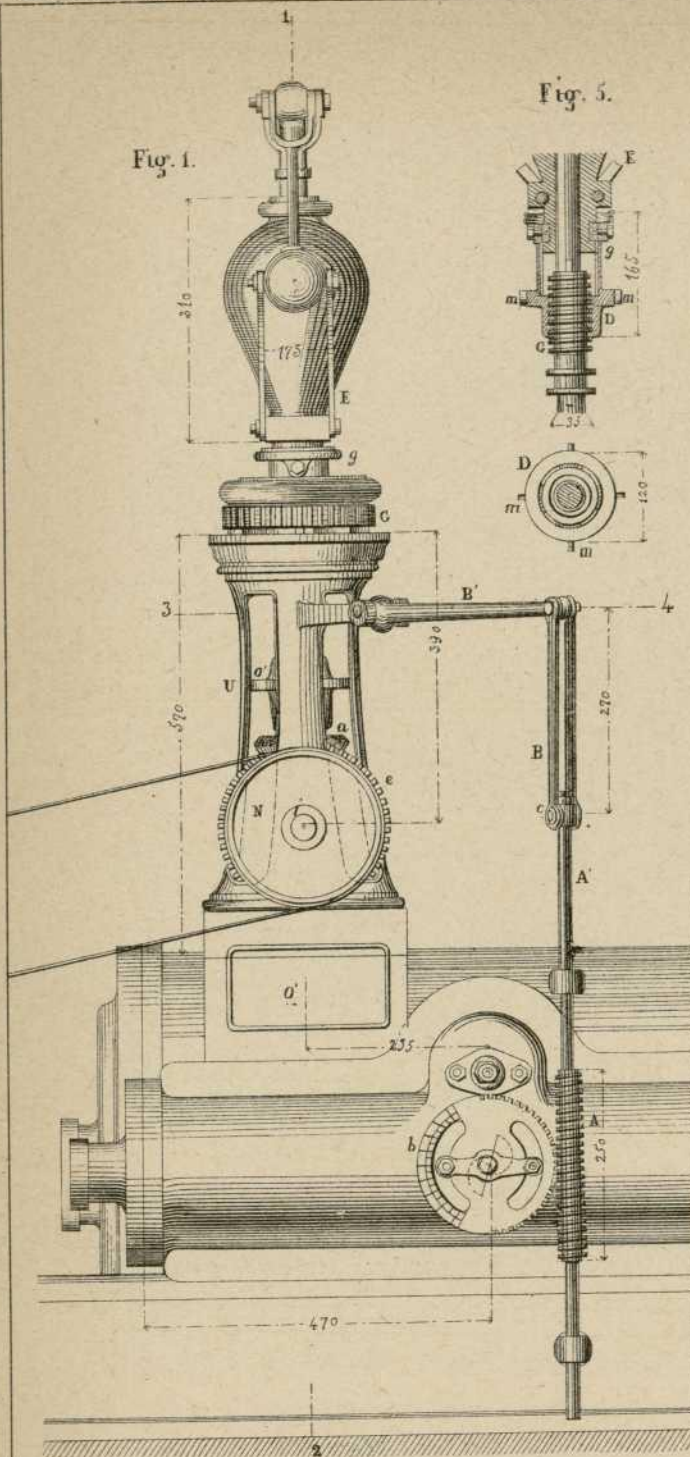


Fig. 6.



Escala de $\frac{1}{10}$

Fig. 7.

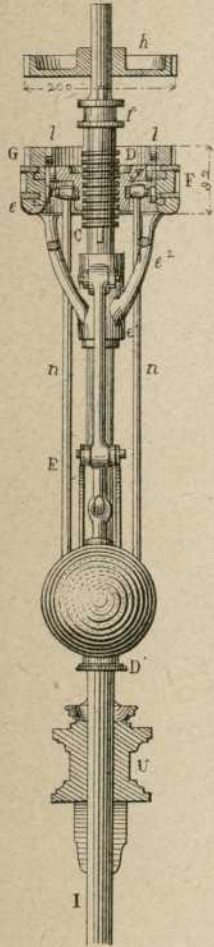


Fig. 8.

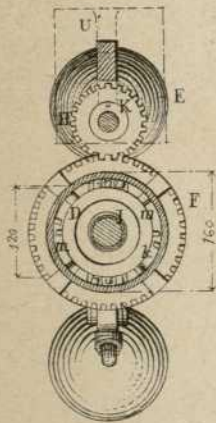
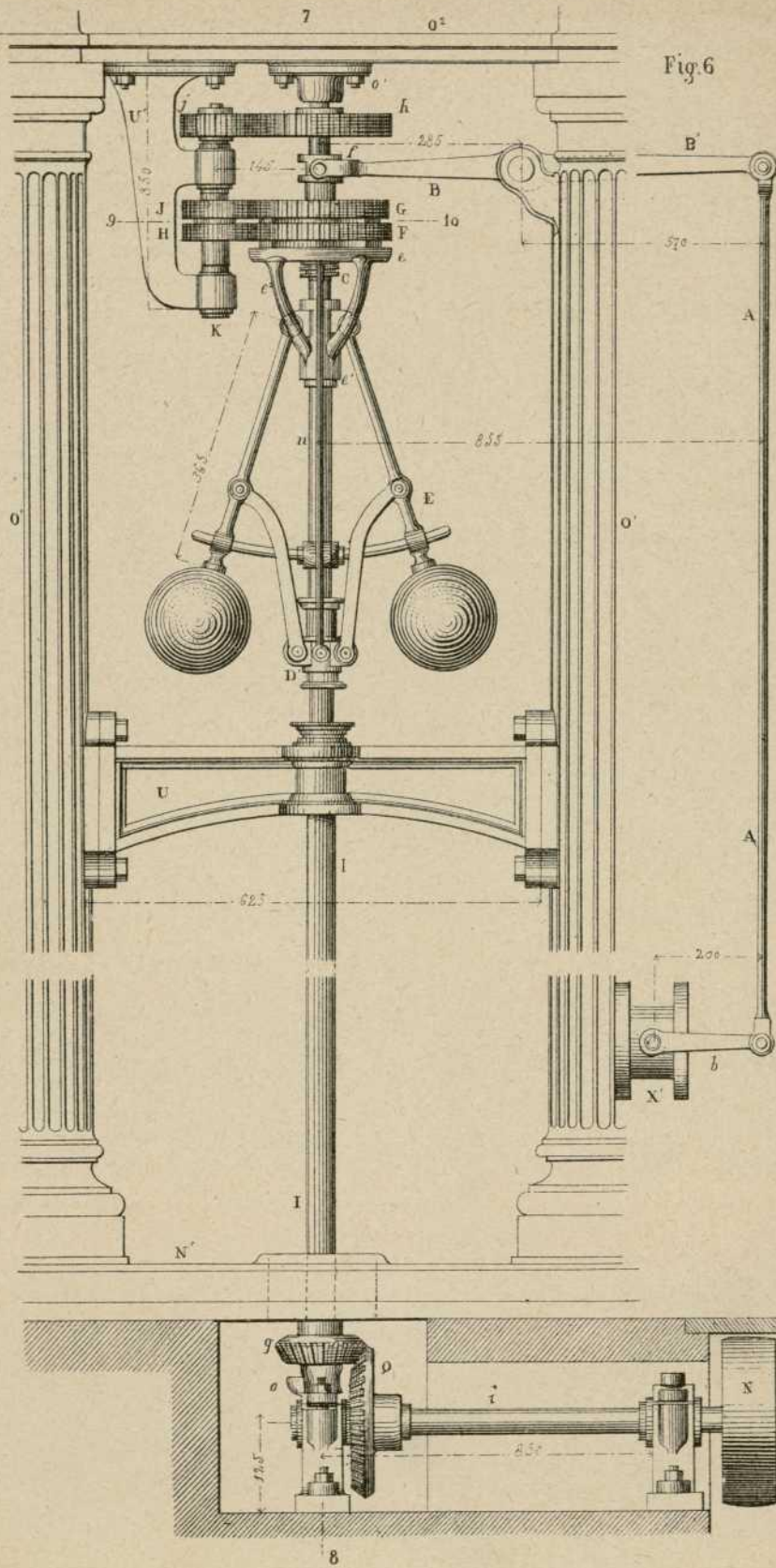


Fig. 6.



EM.

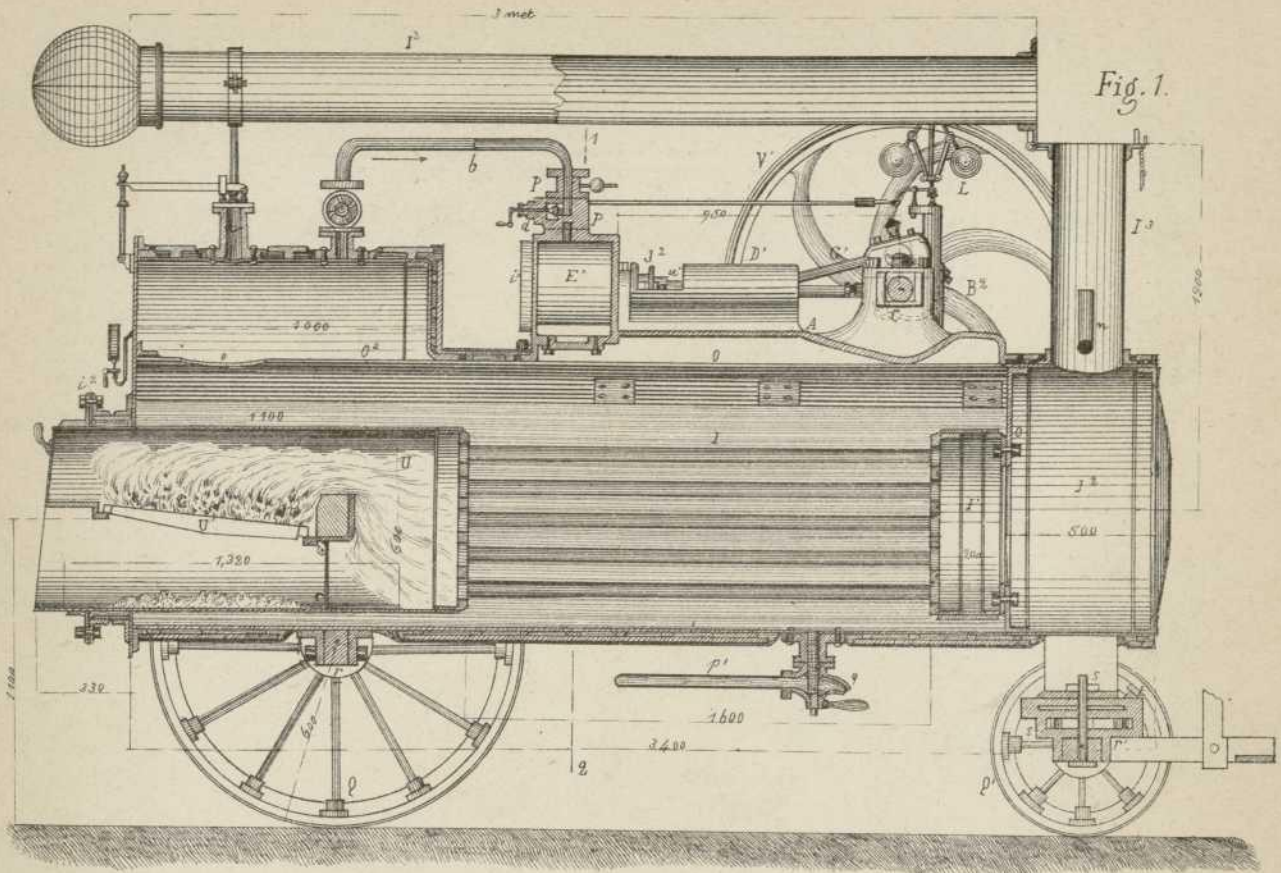


Fig. 1.

Escala de 1/25 por las Fig 1 á 3.

Fig. 2.

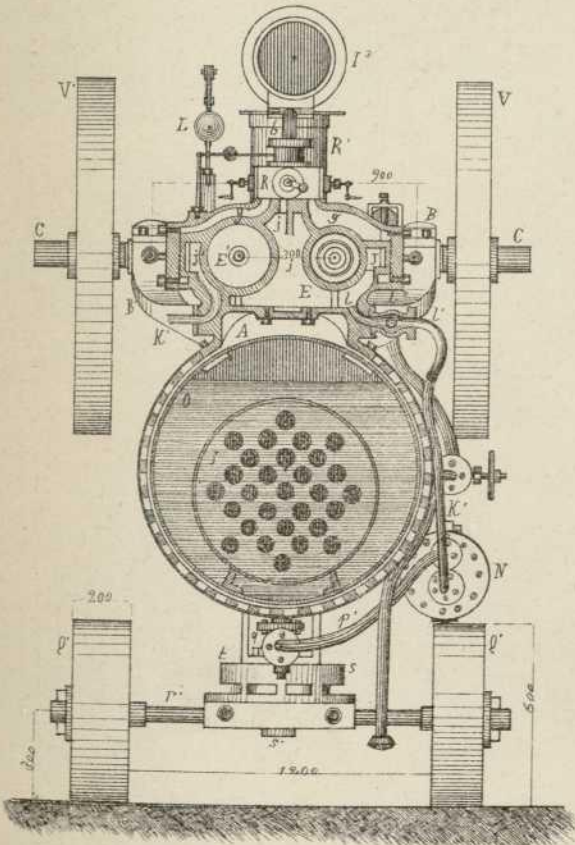
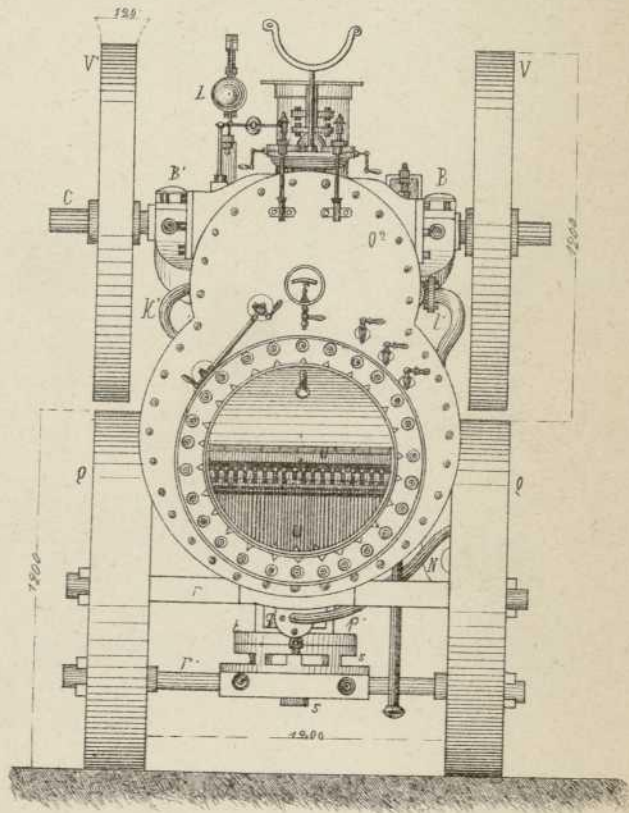
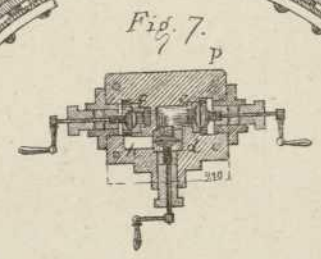
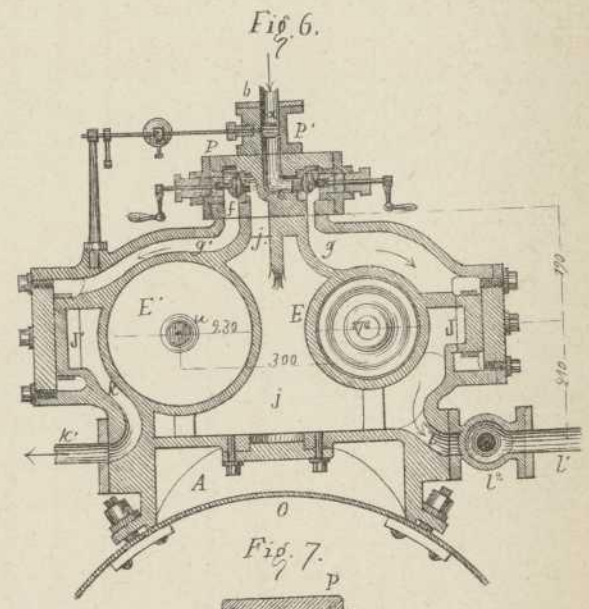
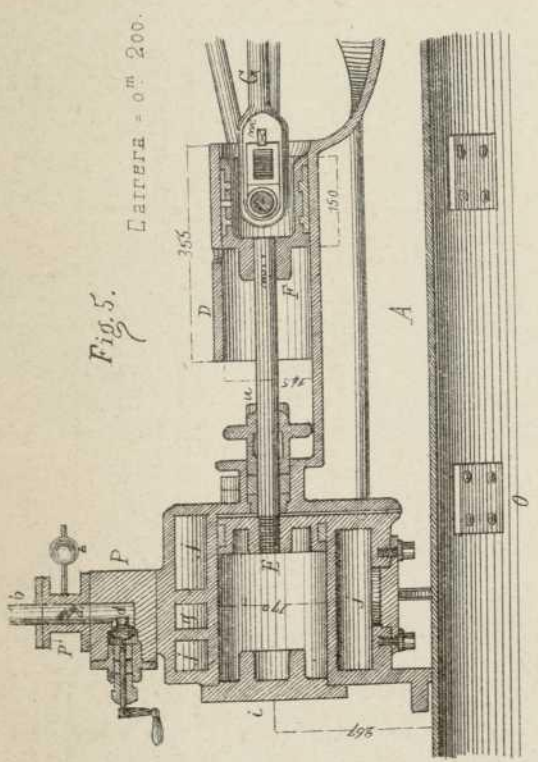
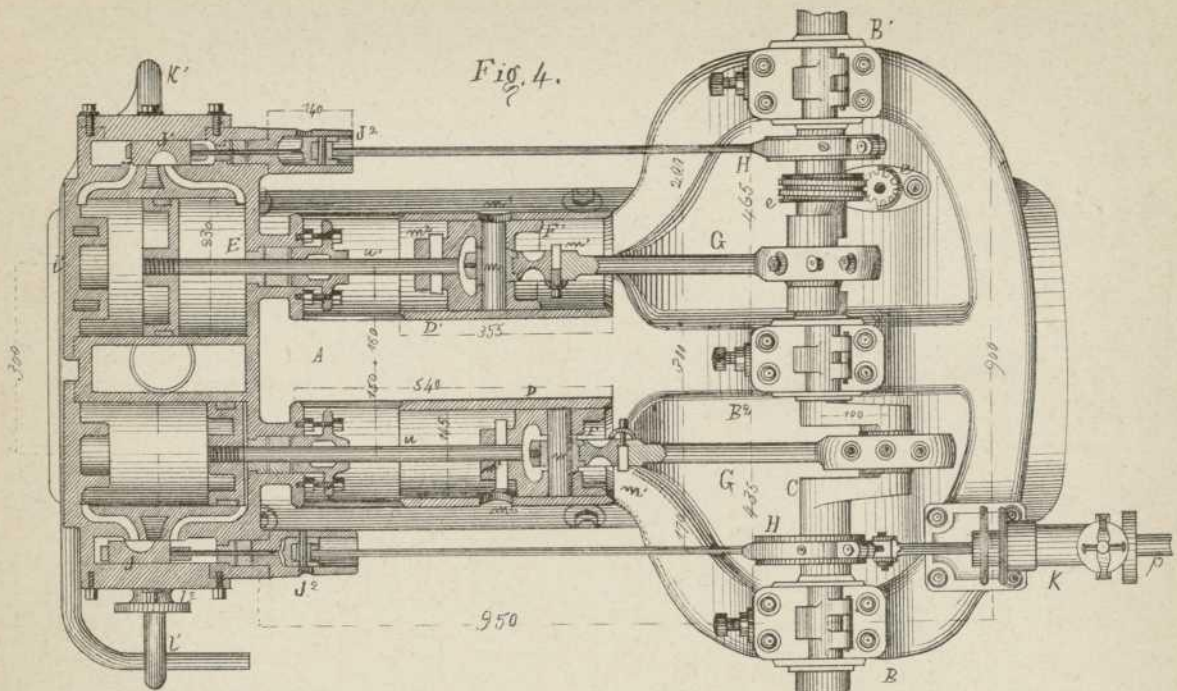


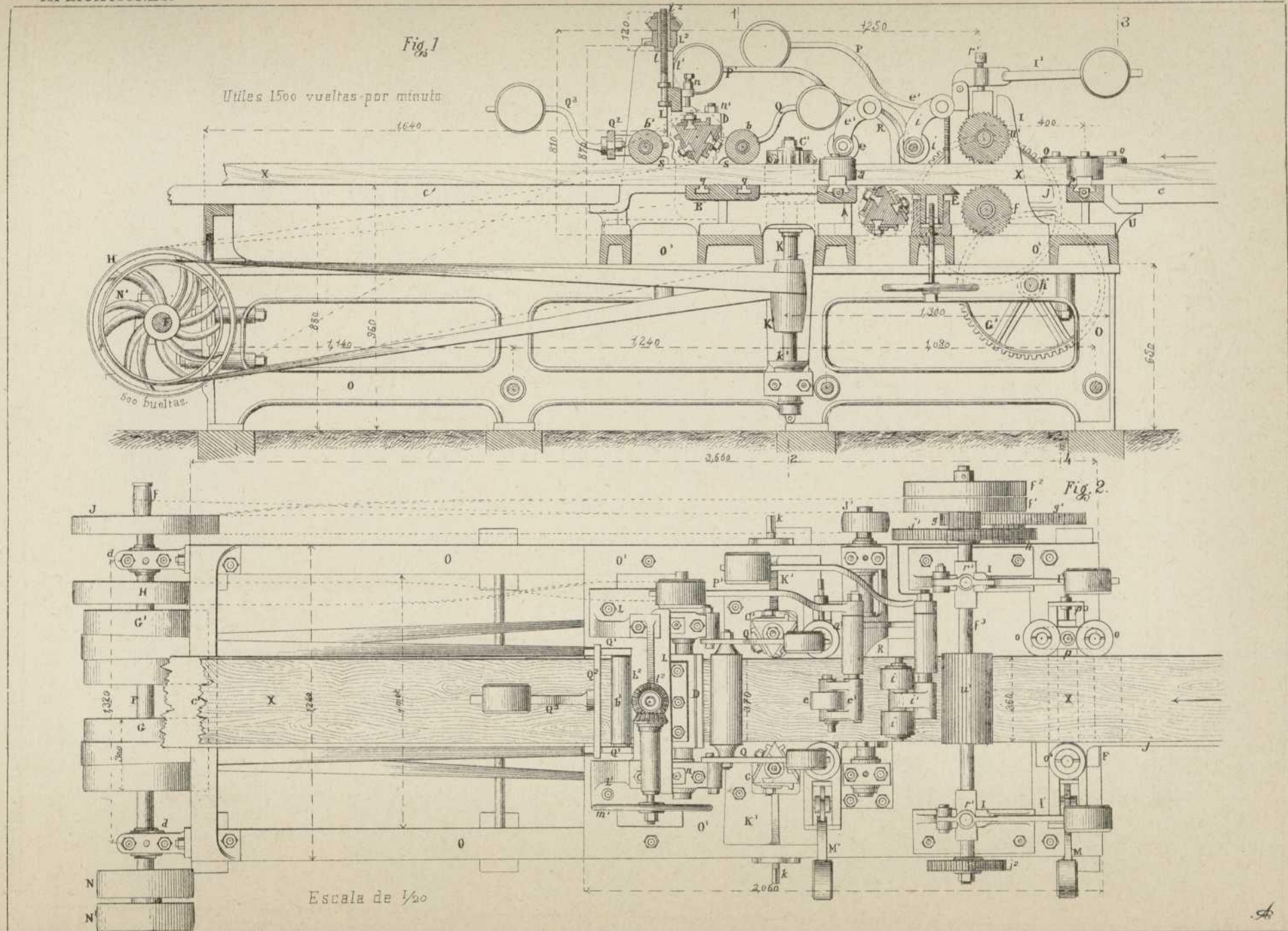
Fig. 3.





Escala de 2/25 por las Fig. 4 à 7.





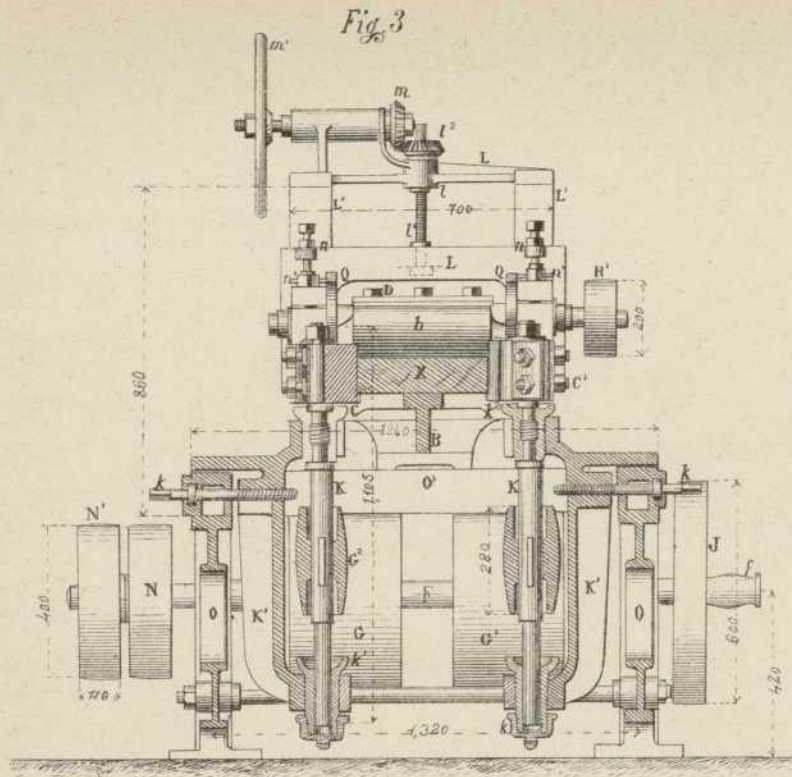


Fig. 7

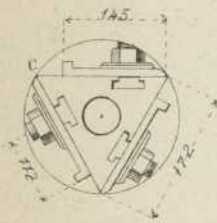


Fig. 4

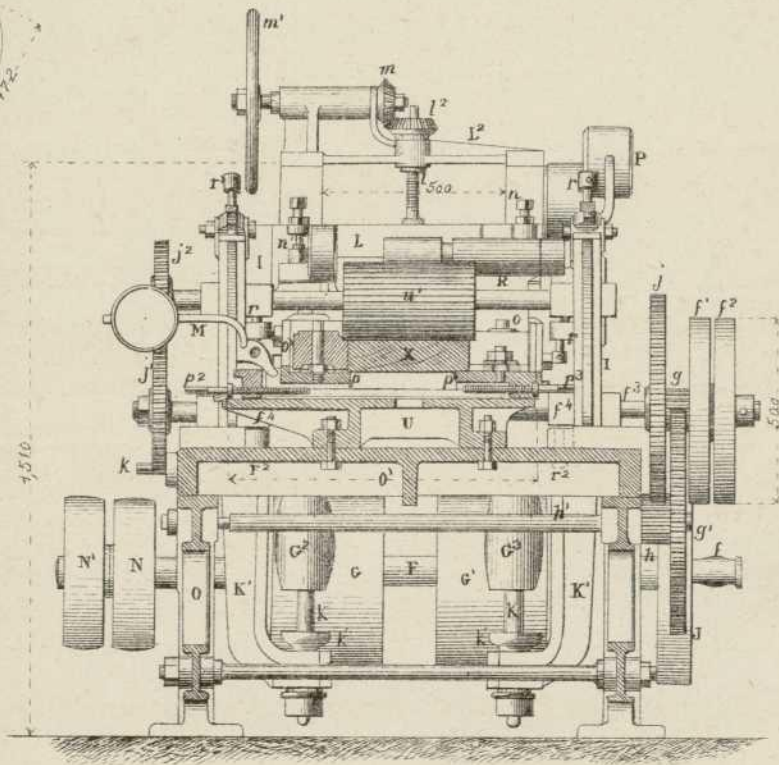


Fig. 6

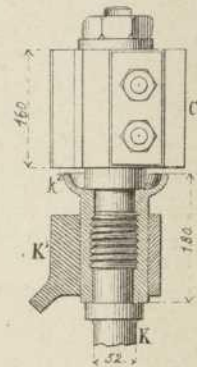


Fig. 1.

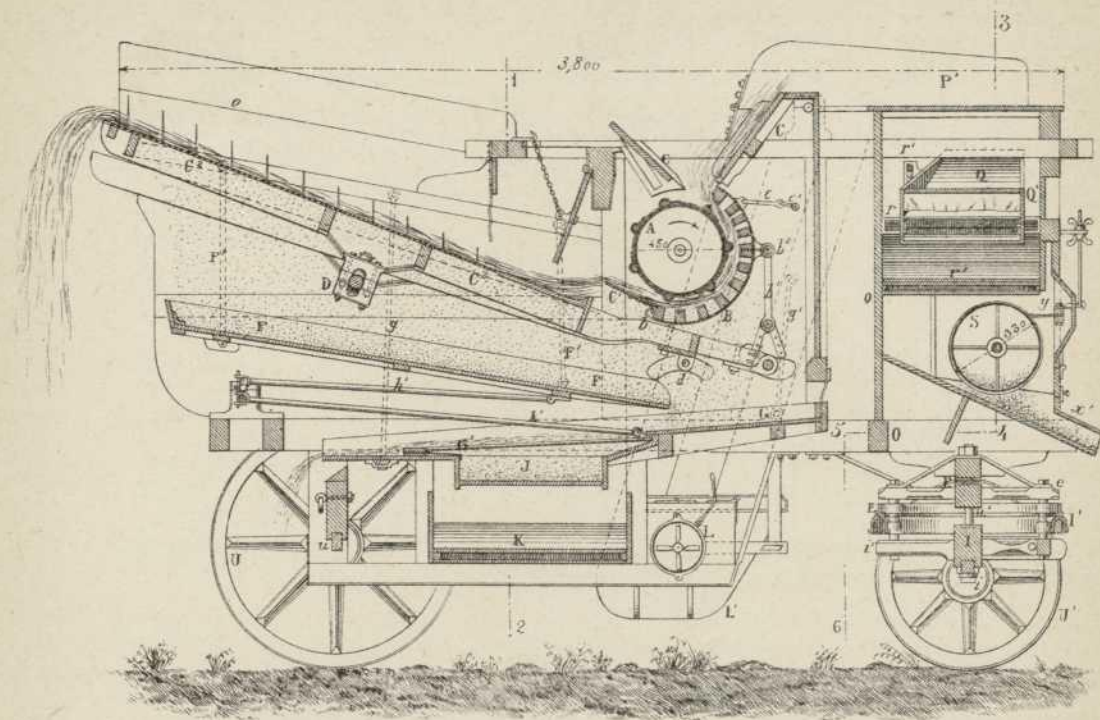


Fig. 2

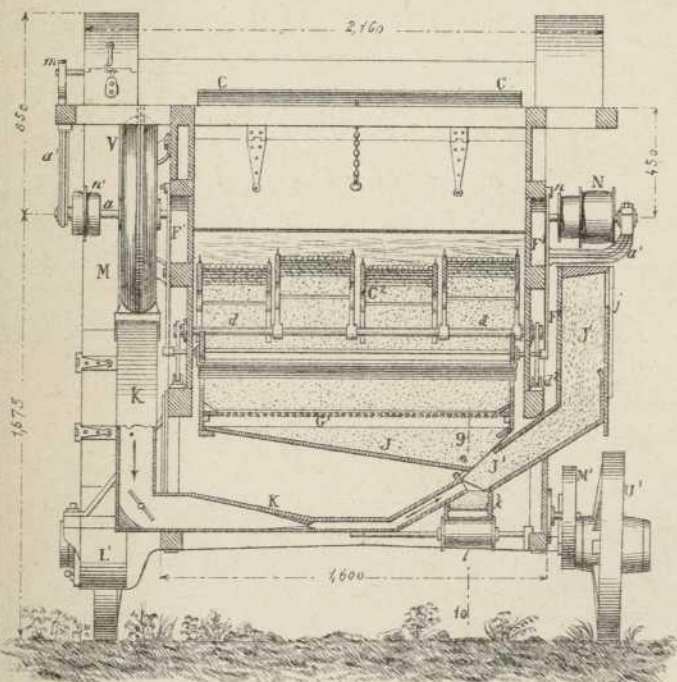
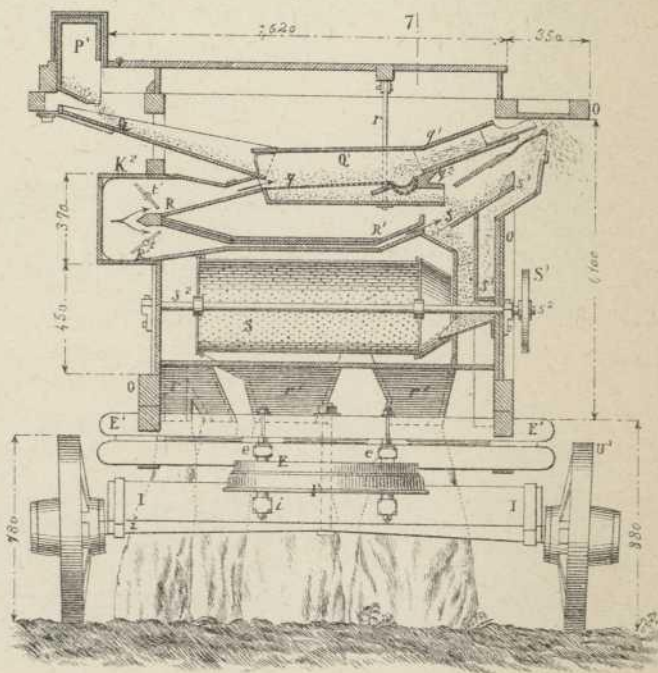
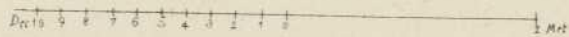


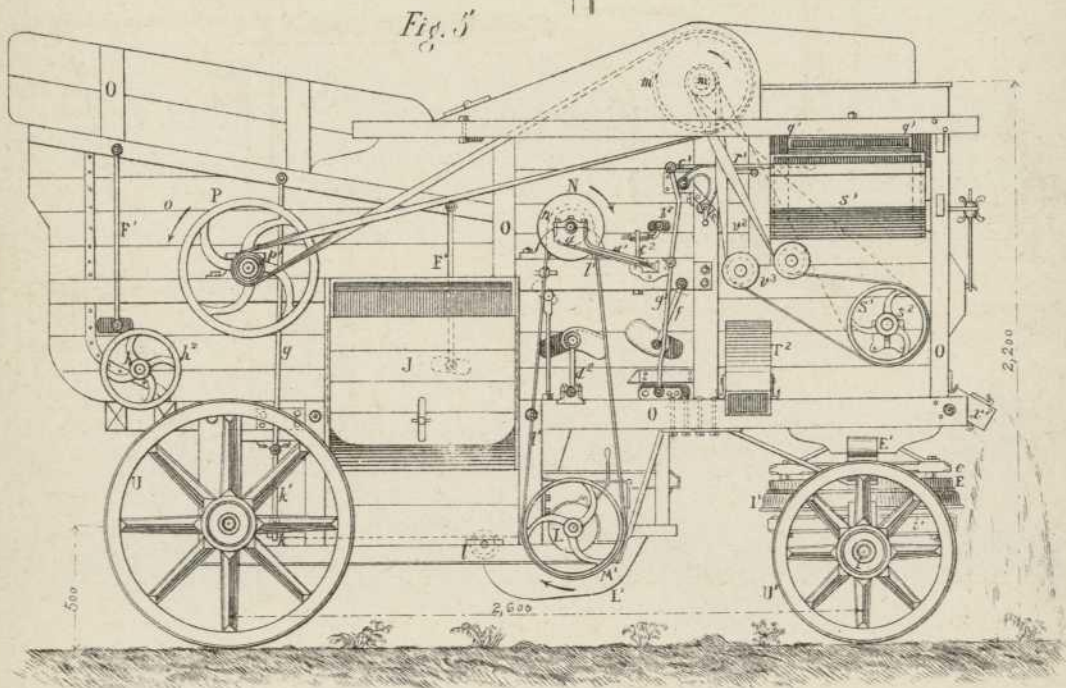
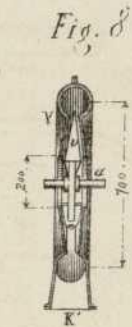
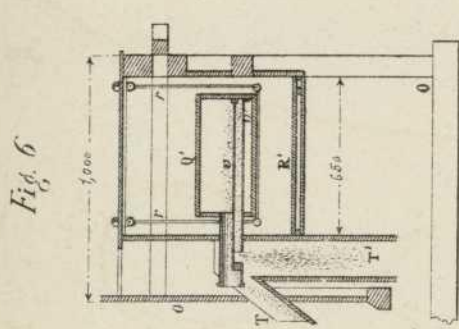
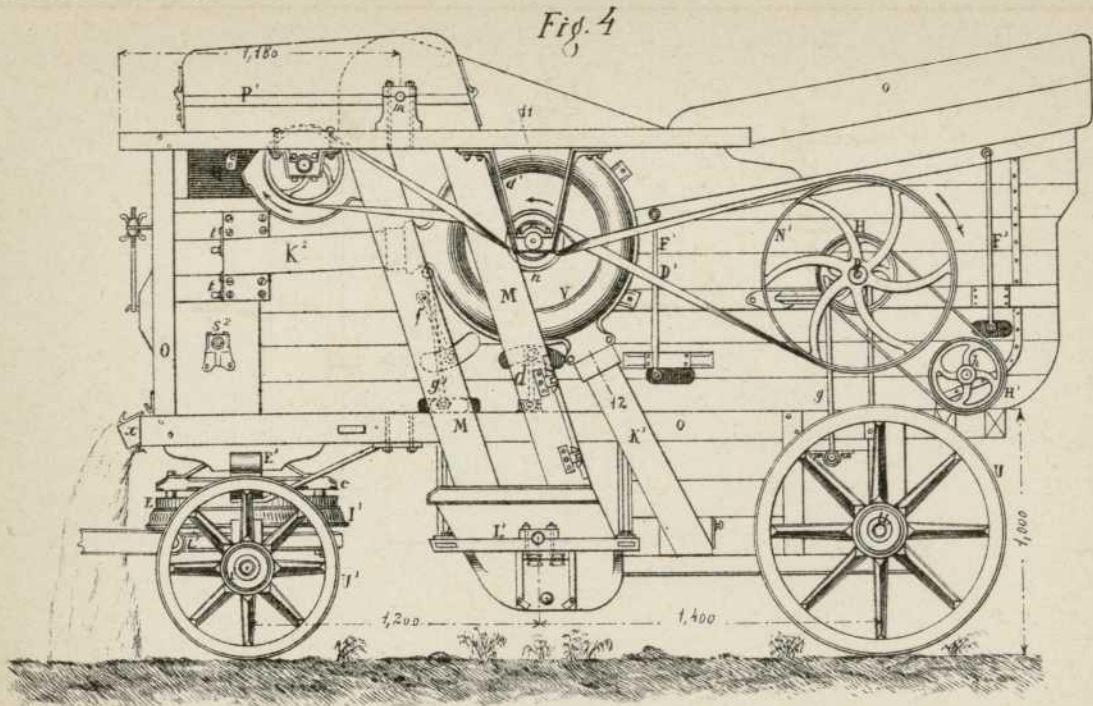
Fig. 3



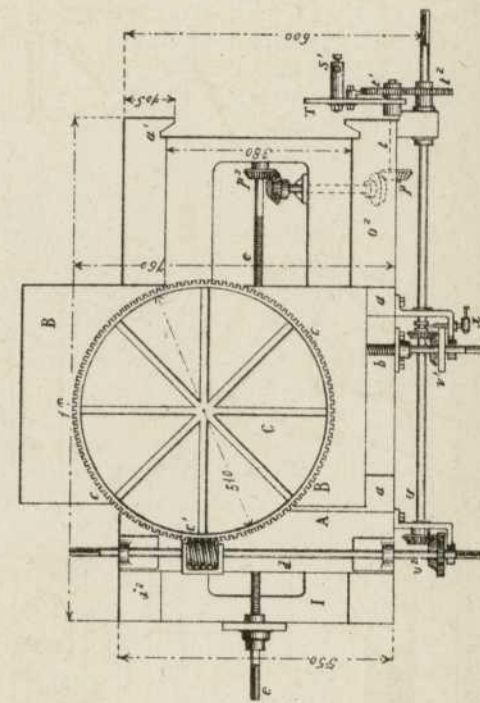
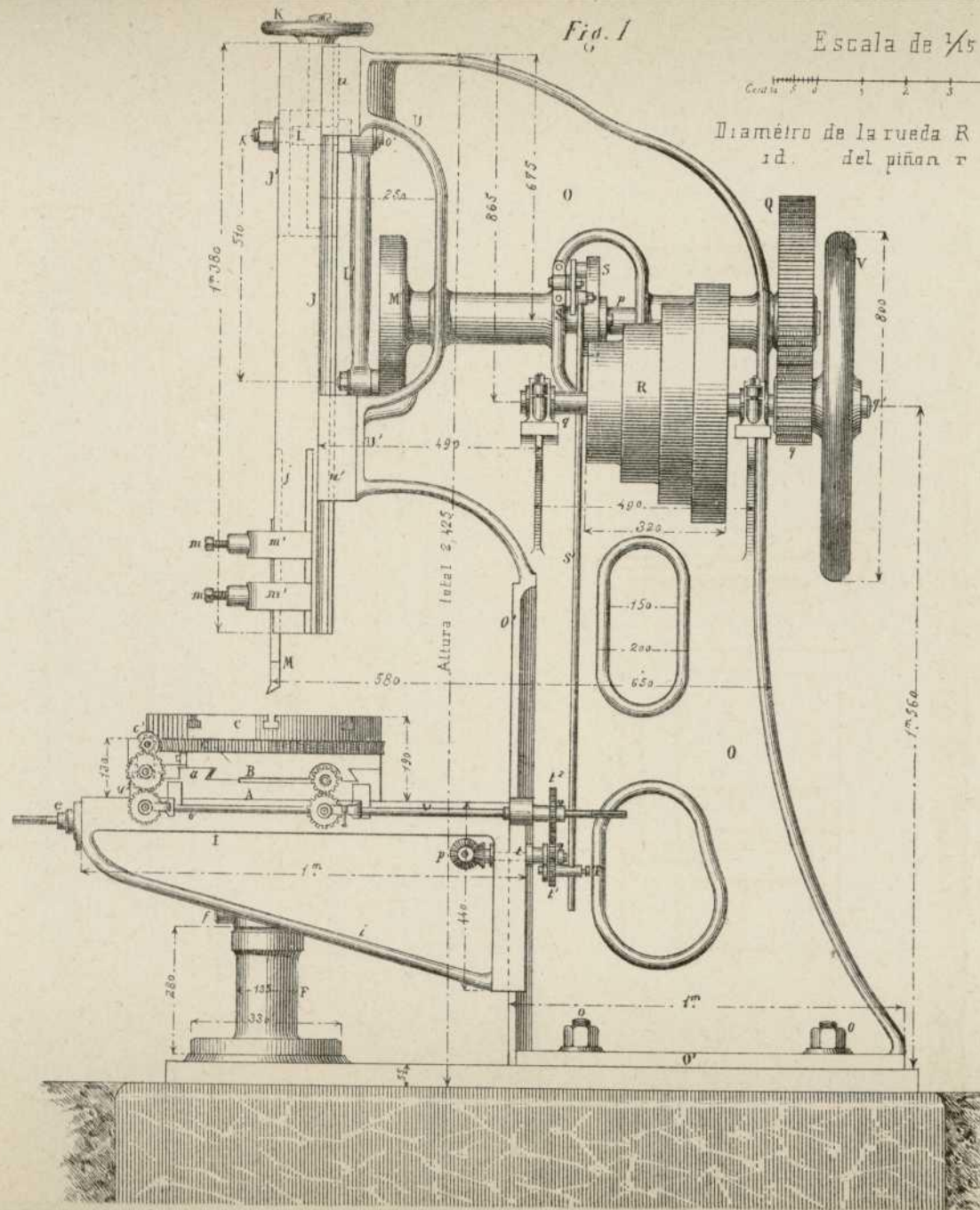
Escala de 1/30



B



⒃



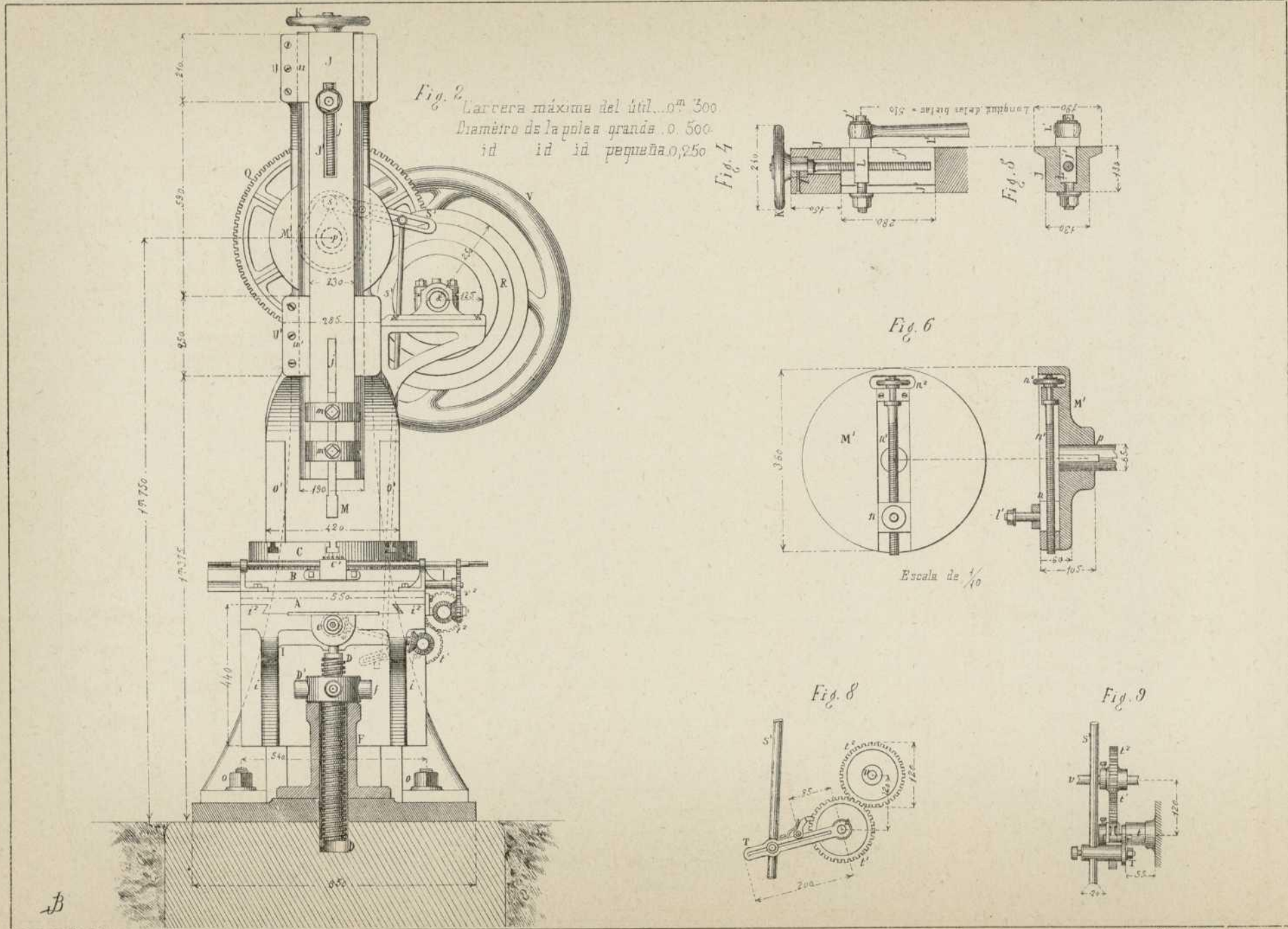


Fig. 5.

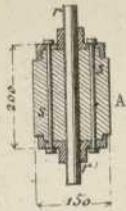


Fig. 9.

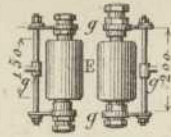


Fig. 4.

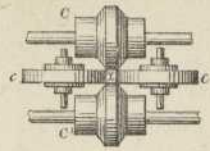


Fig. 10.

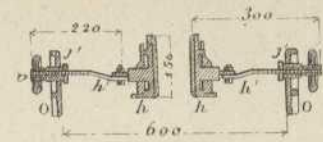


Fig. 8.

Escala de 1/20

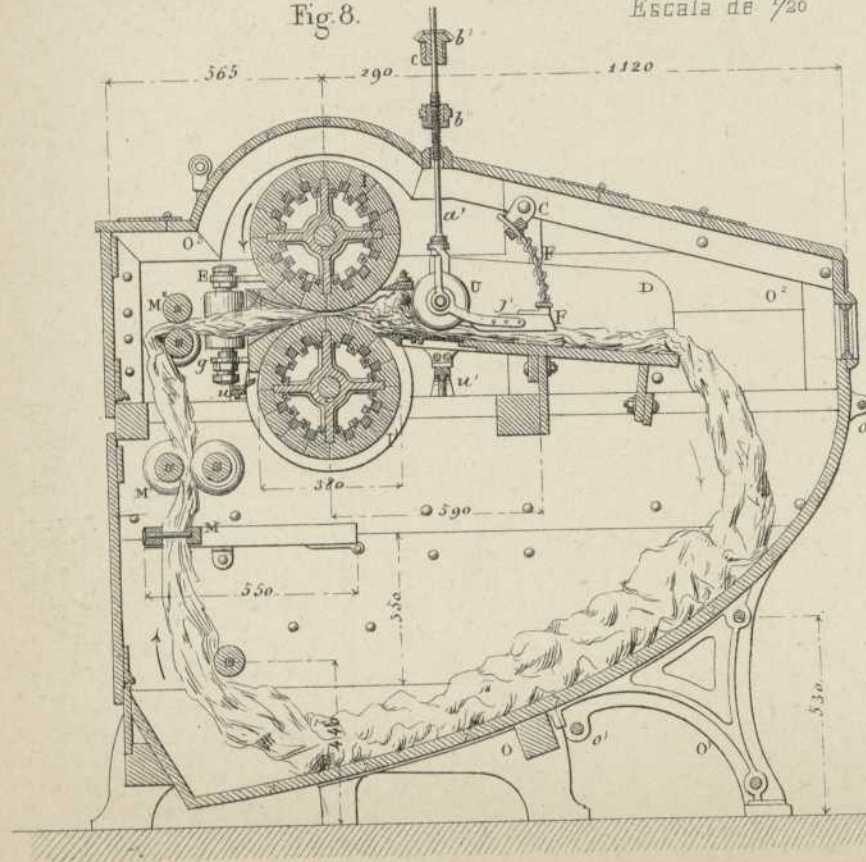


Fig. 6.

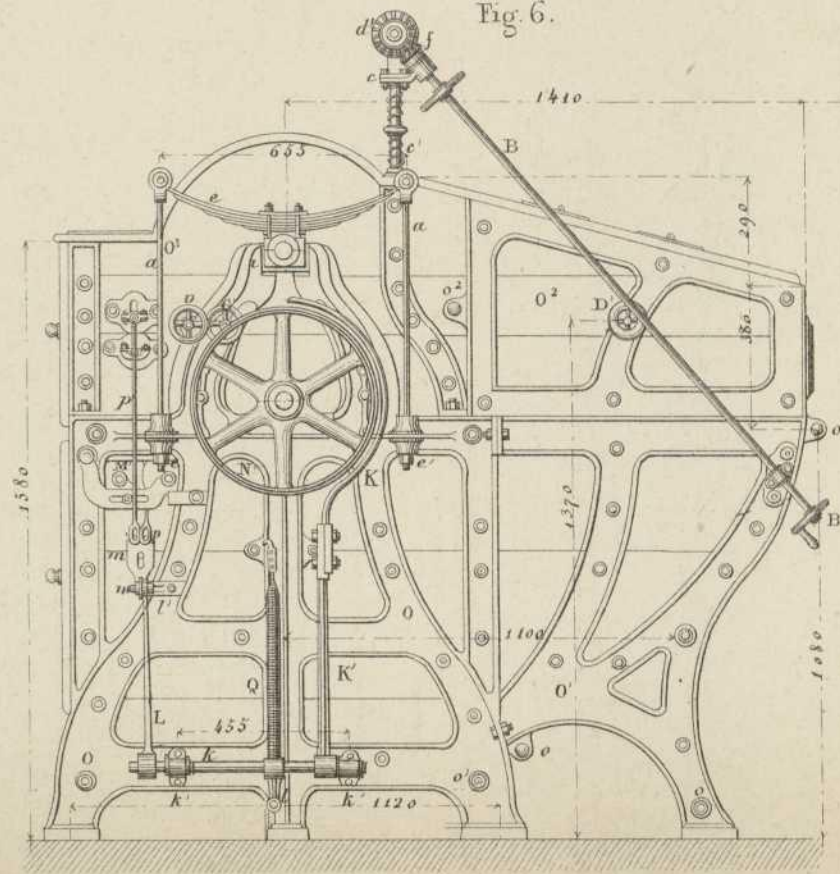


Fig. 3

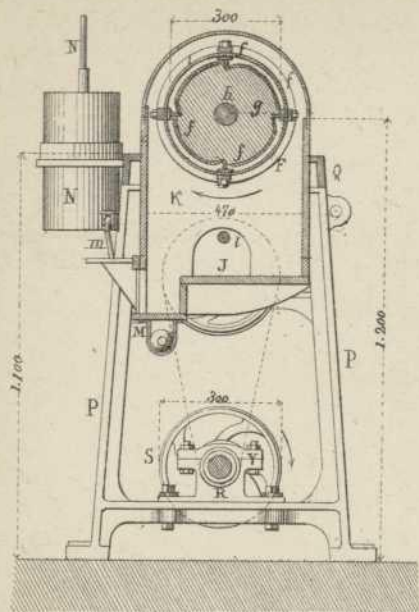


Fig. 1.

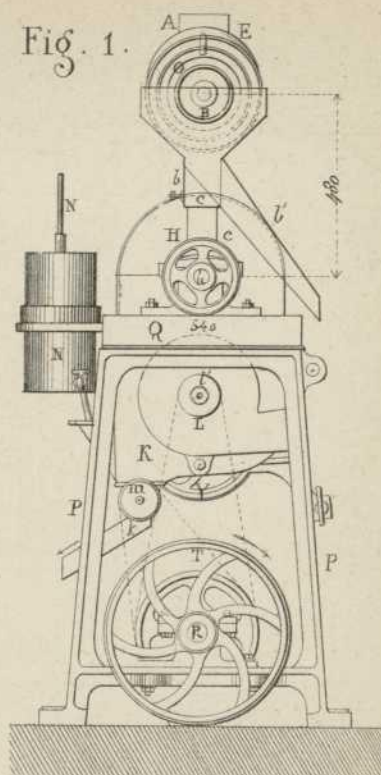


Fig. 4

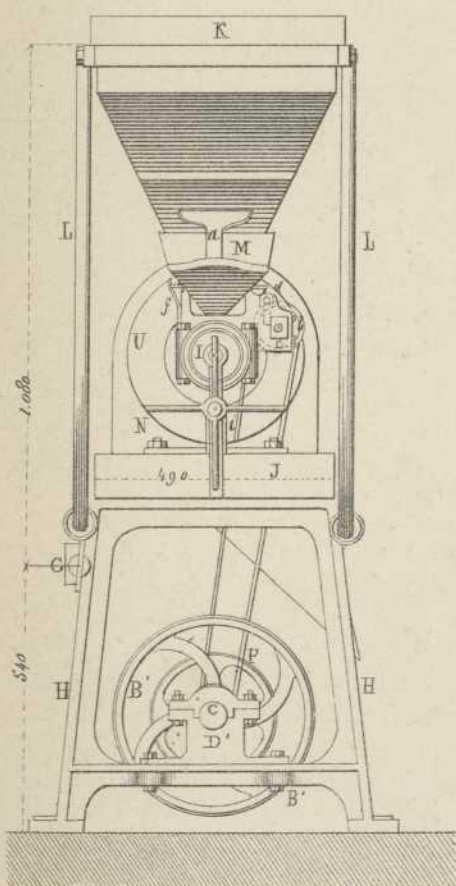
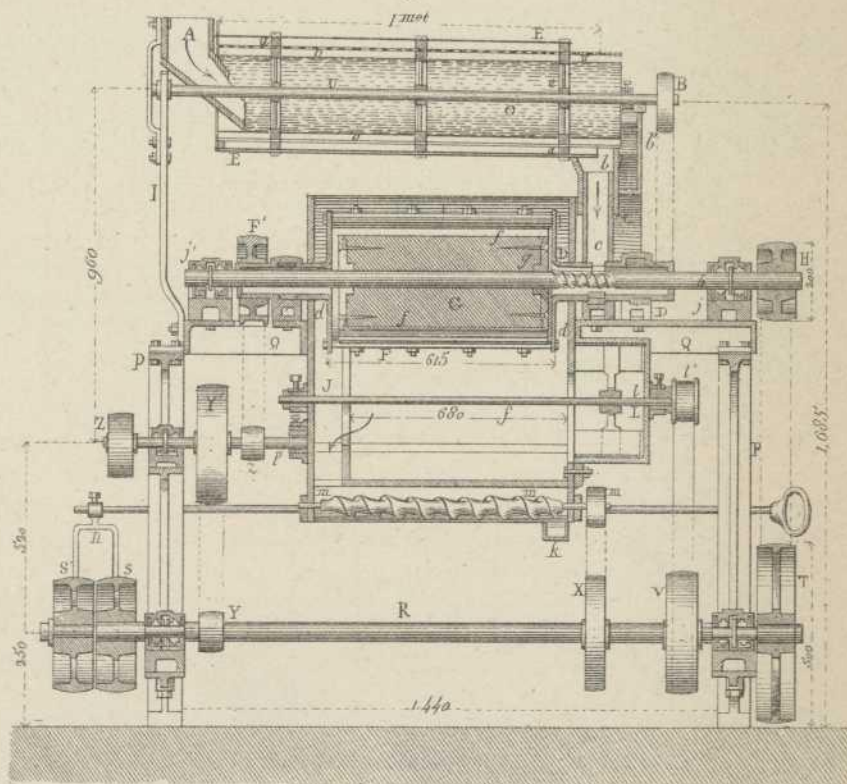


Fig. 2.



Escala de 1/20 por las Fig. 1 à 3. 7 y 8.

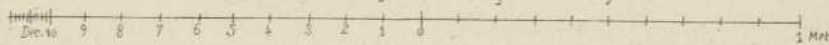


Fig 5.

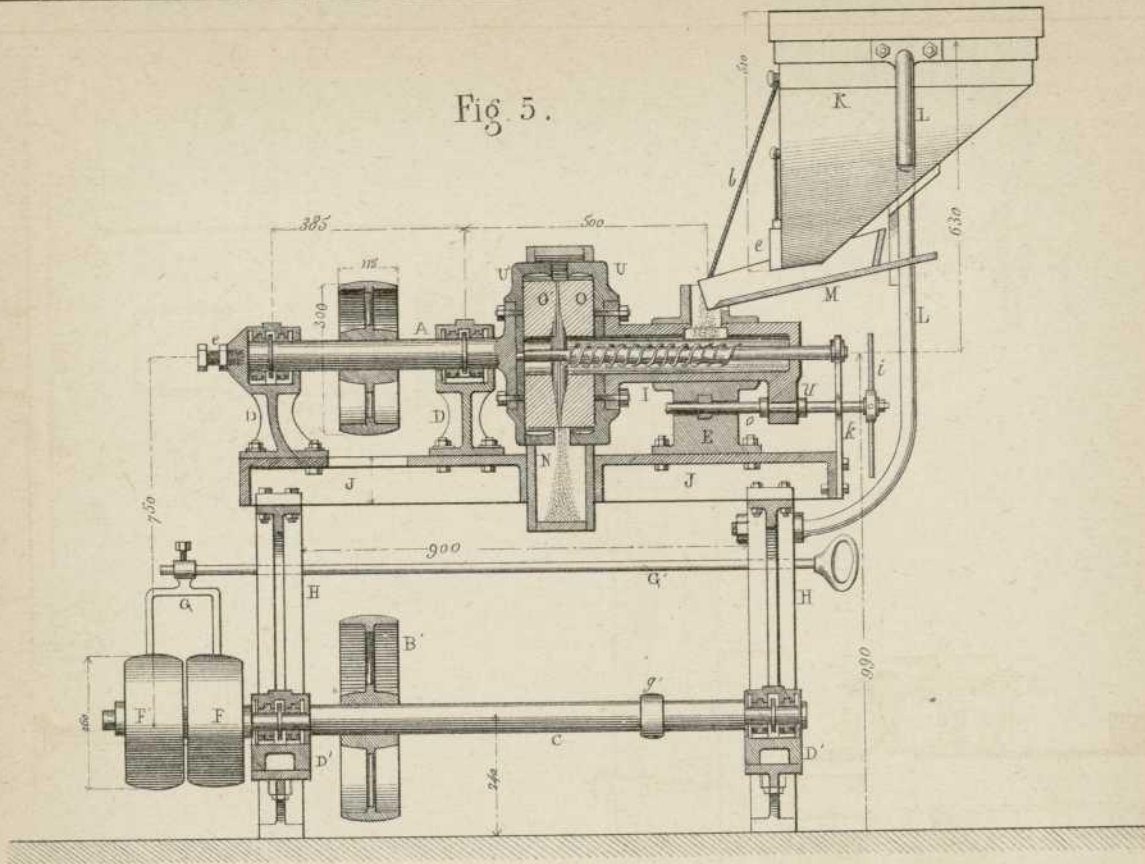
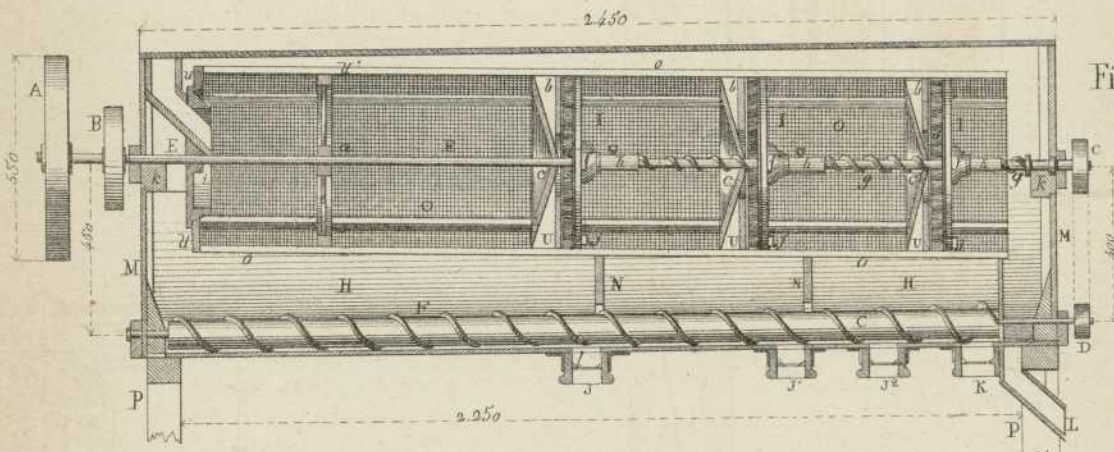


Fig. 7



Escala de 1/10 por las Fig. 4 a 6

Fig. 6.

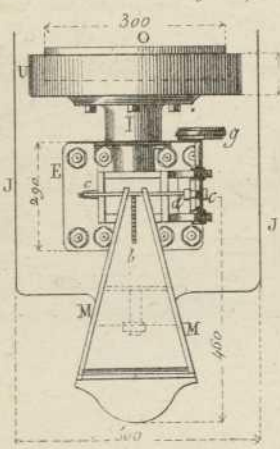


Fig. 8.

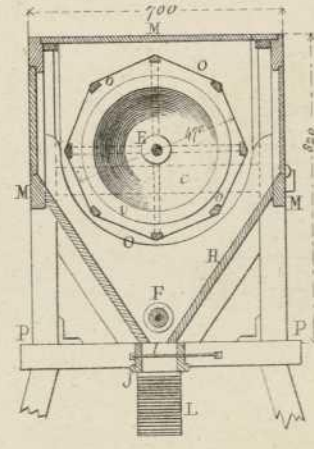


Fig. 1.

Fig. 6.

Fig. 5.

Fig. 3.

Fig. 2.

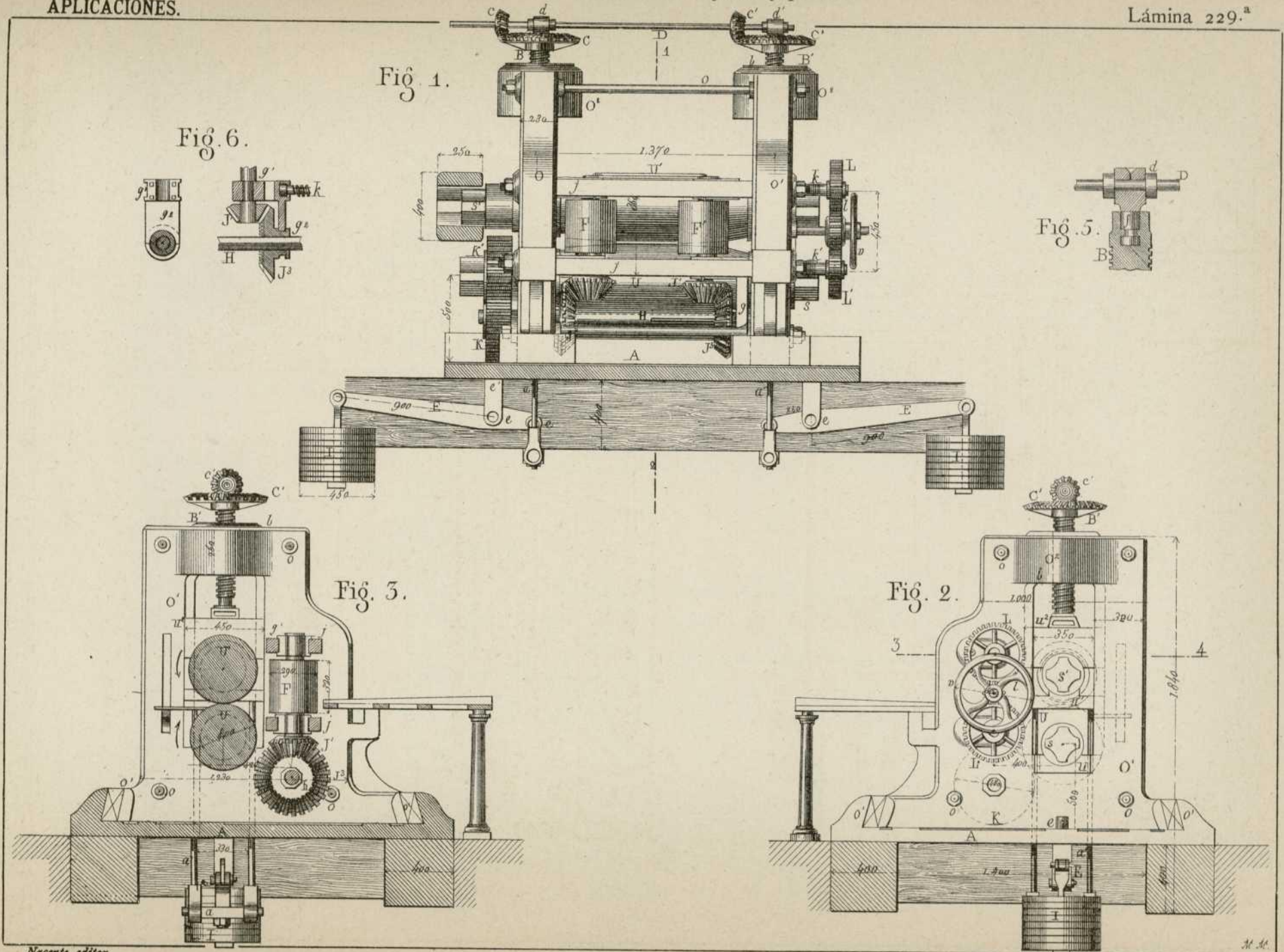


Fig. 9.

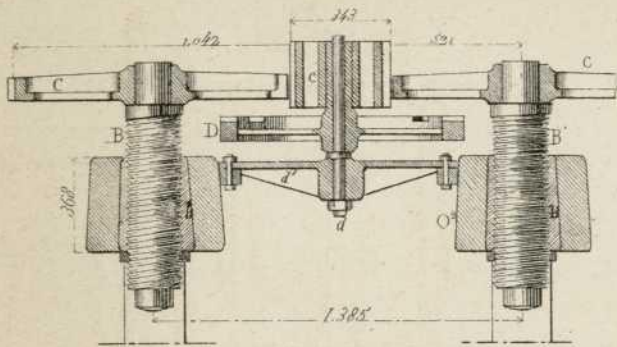


Fig. 4.

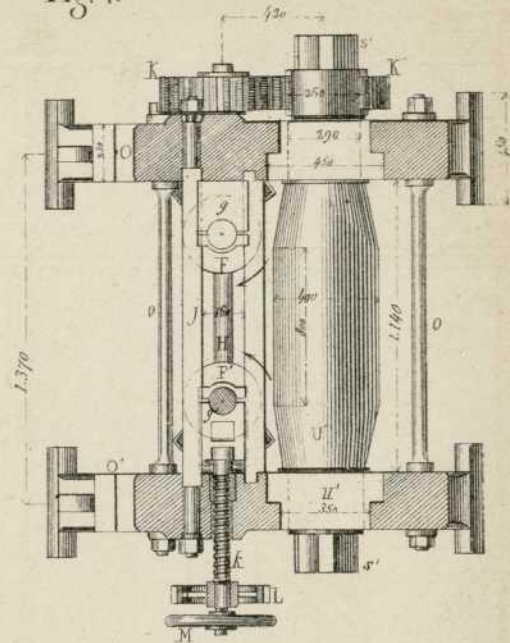


Fig. 10.

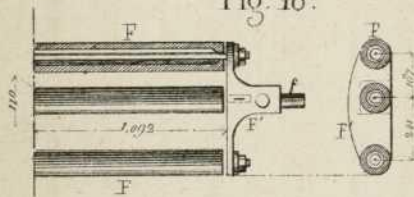


Fig. 7.

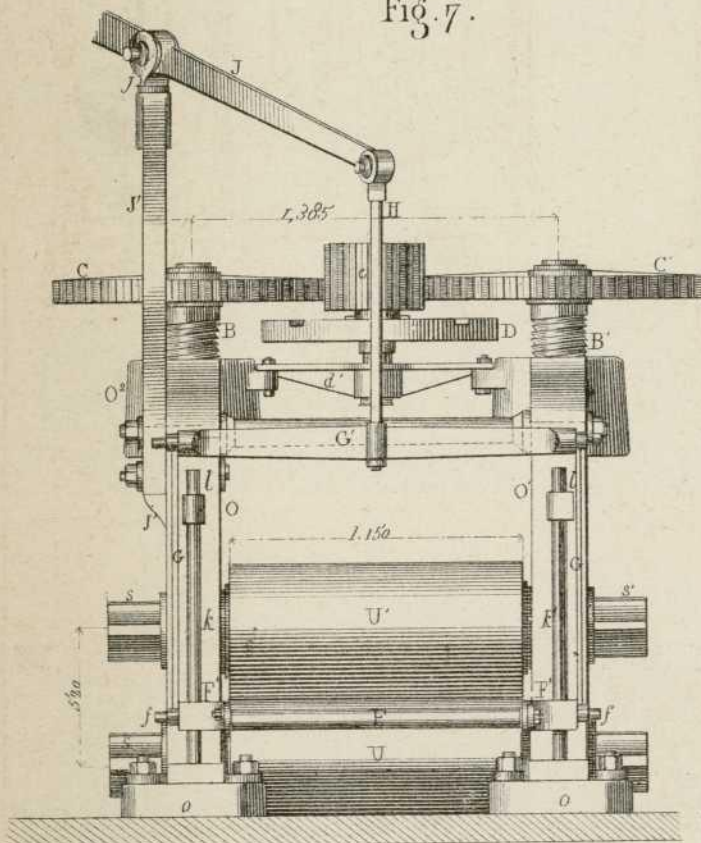
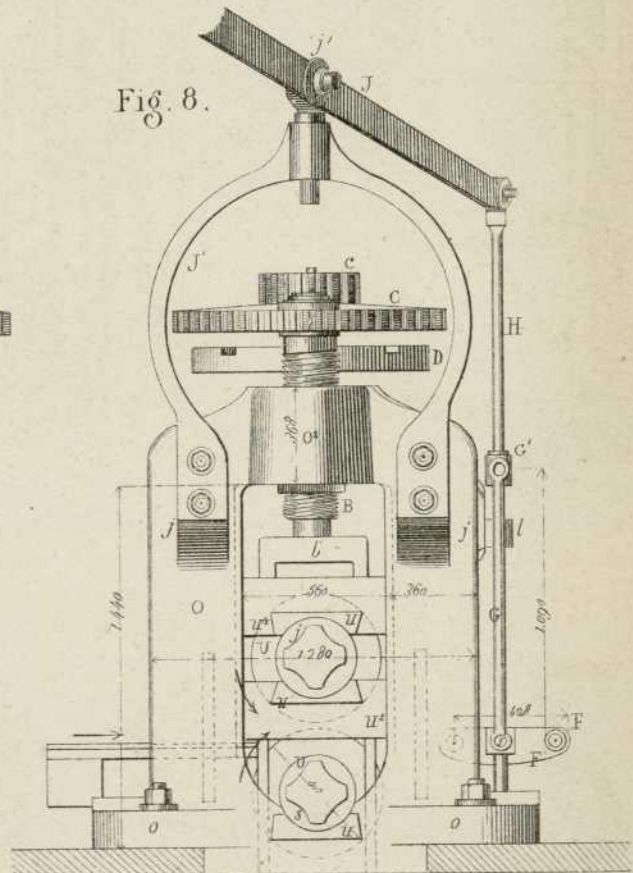
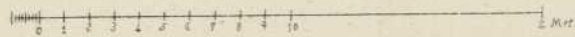
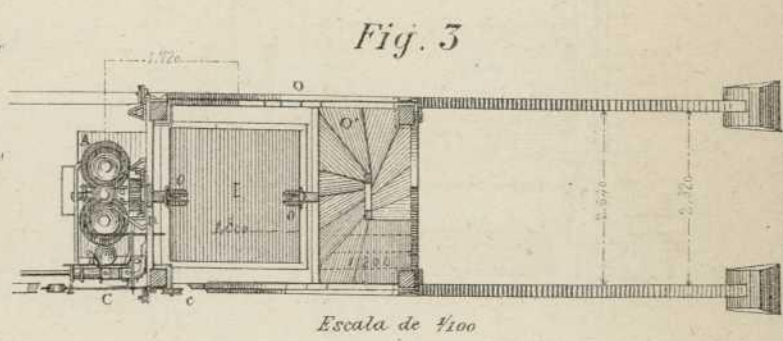
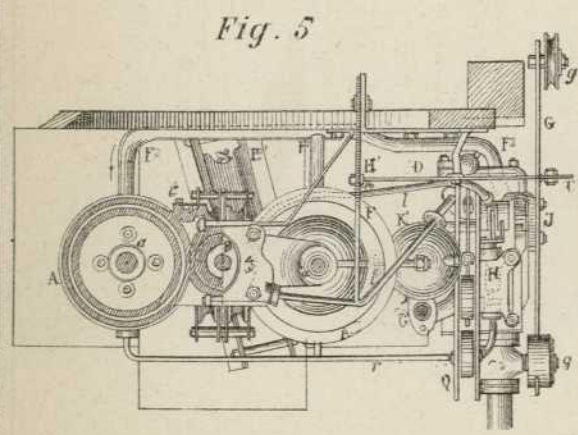
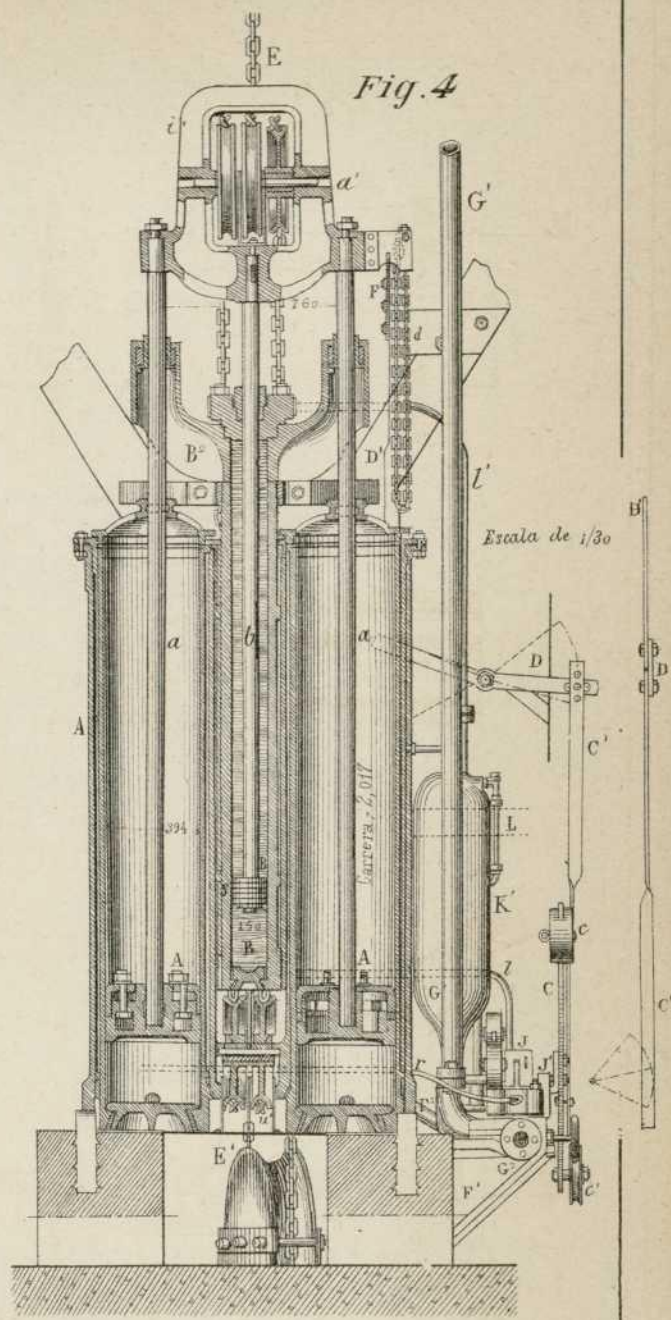
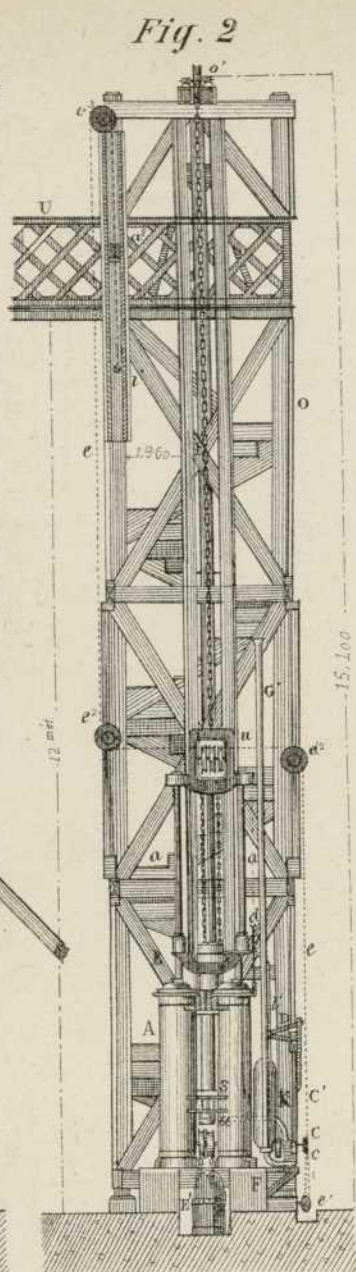
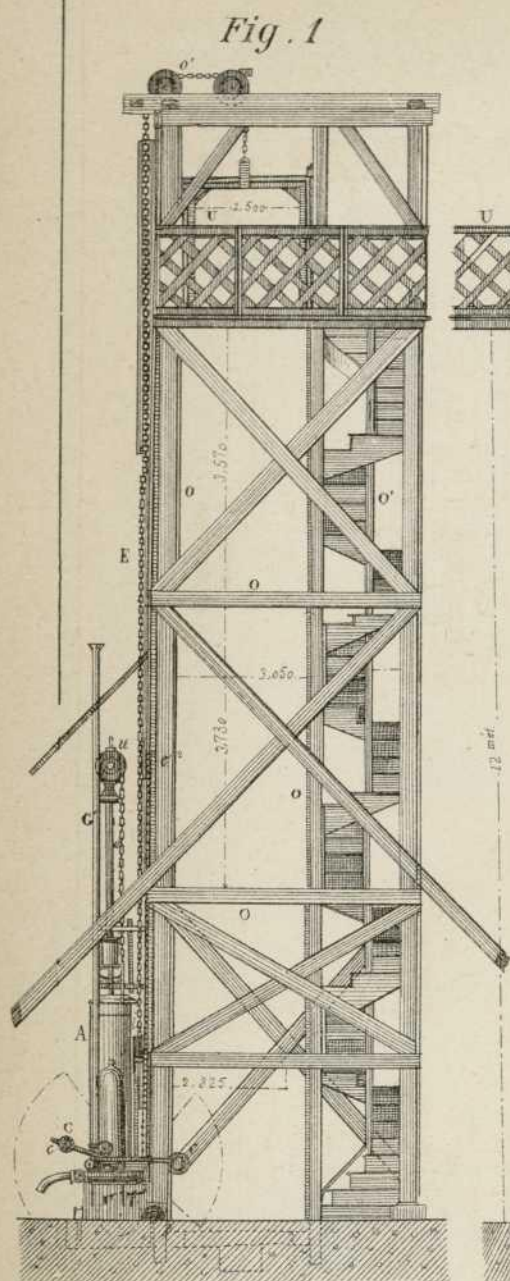


Fig. 8.



Escala de 1/30





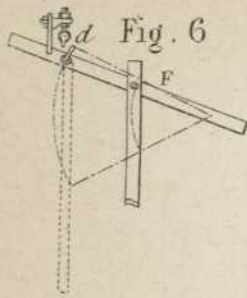


Fig. 6

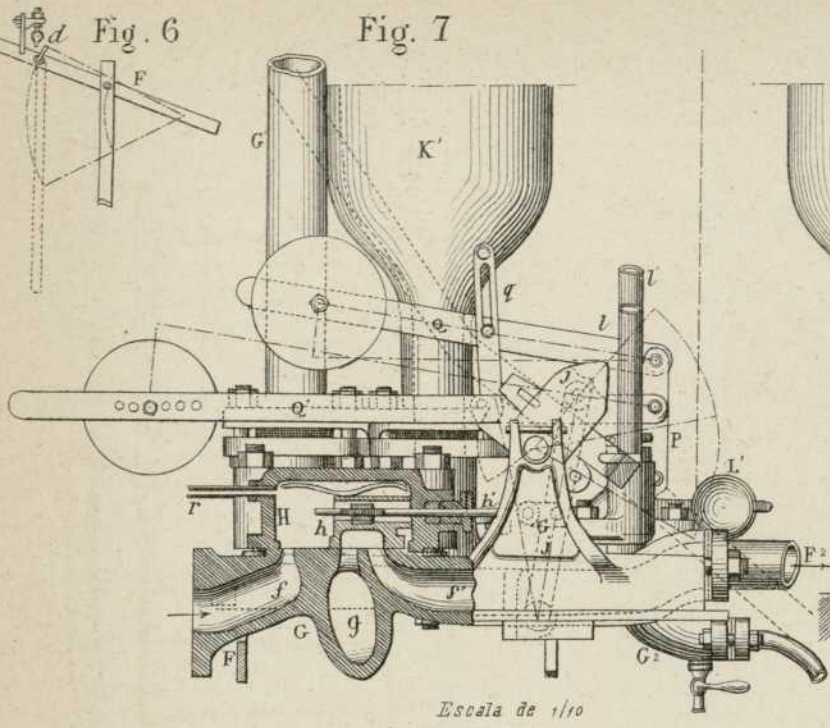


Fig. 7

Escala de 1/10

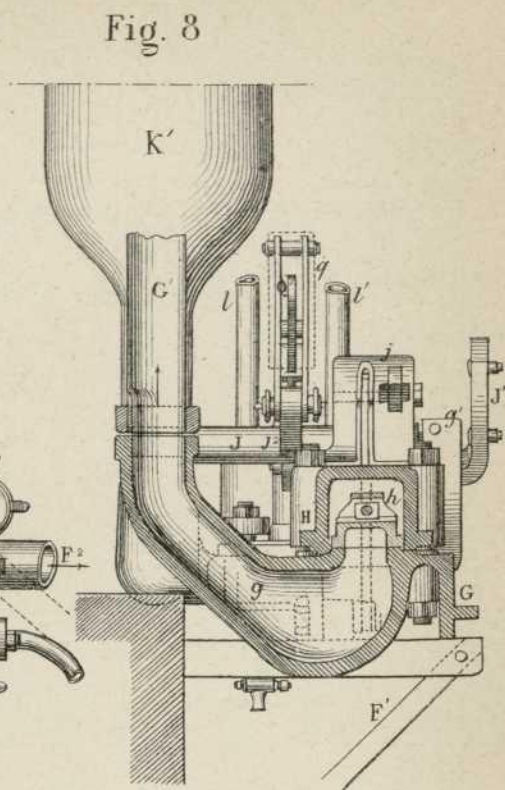


Fig. 8

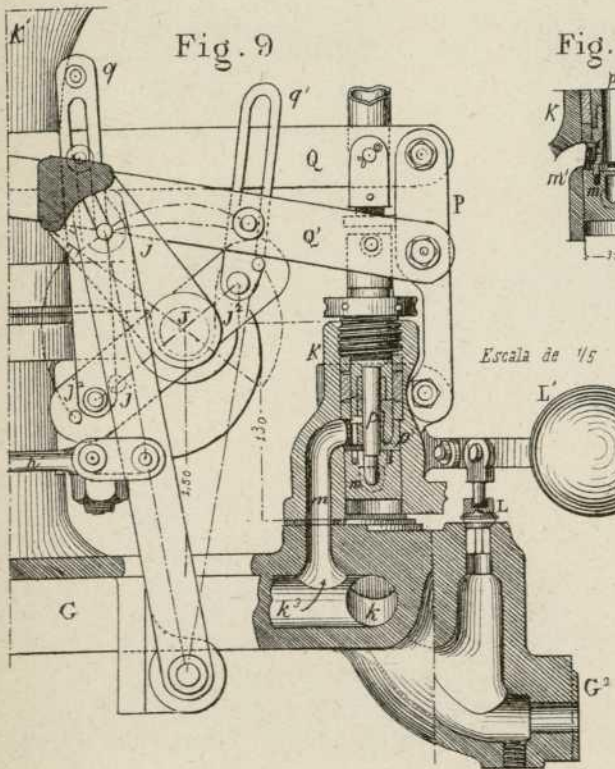


Fig. 9

Escala de 1/5

Fig. 11

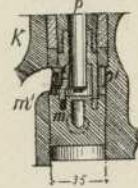


Fig. 10

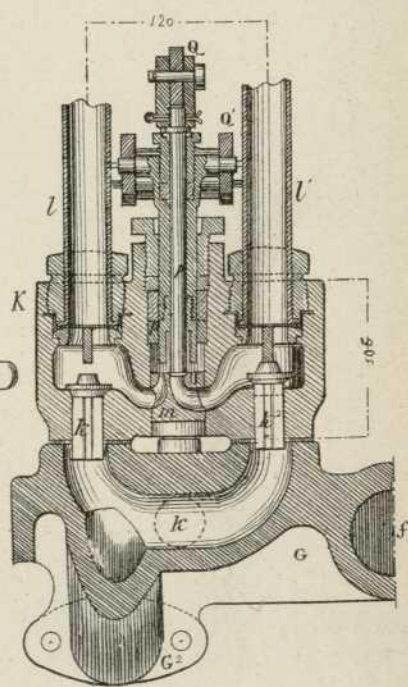


Fig. 1

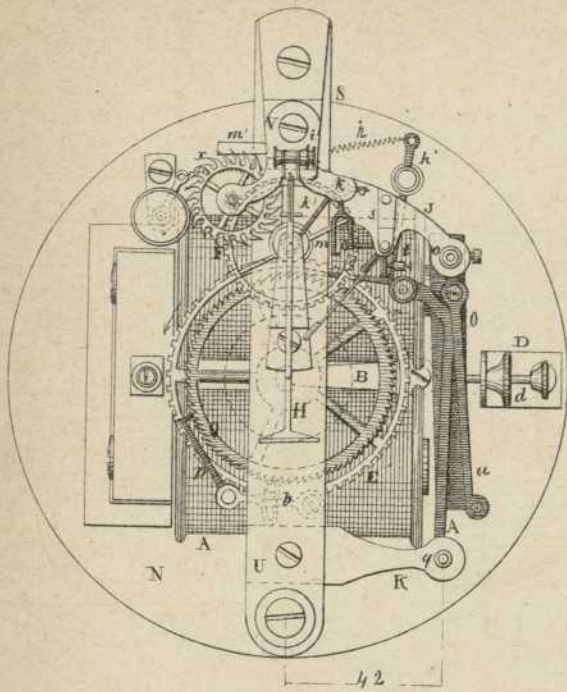


Fig. 2

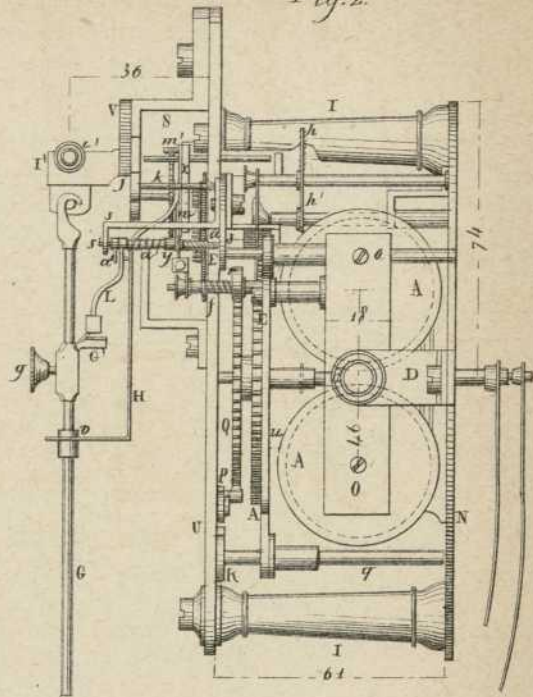


Fig. 3.

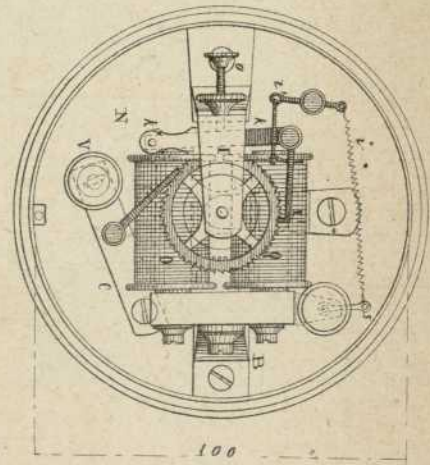
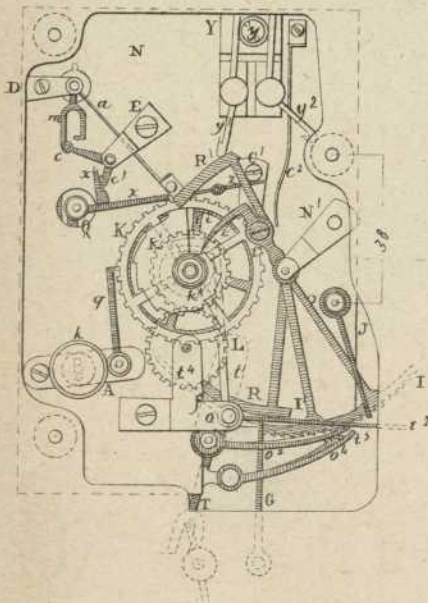
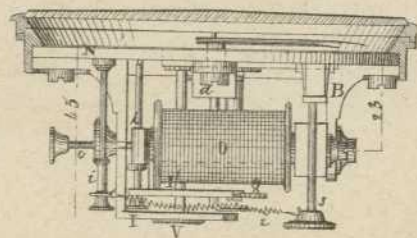
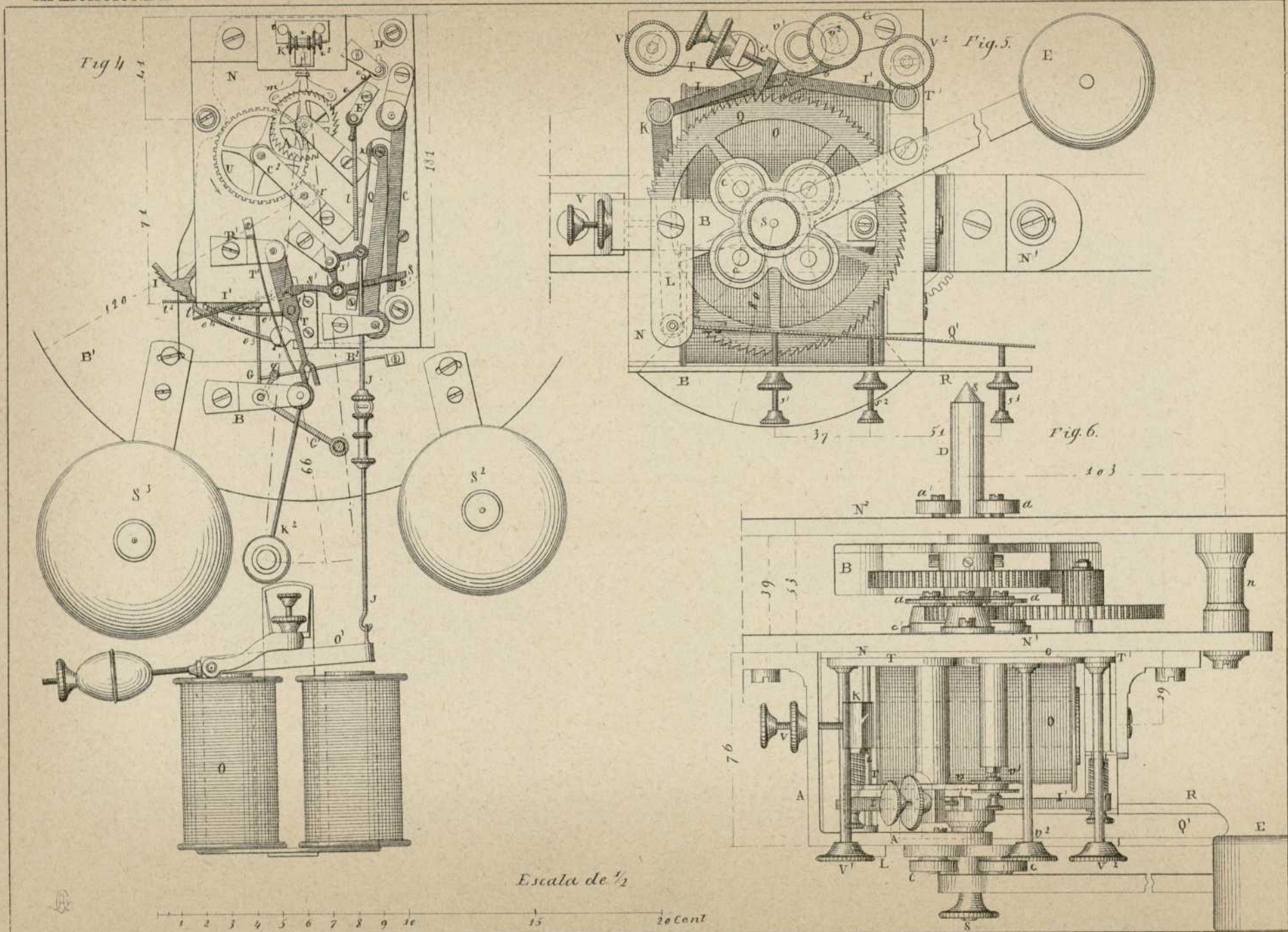


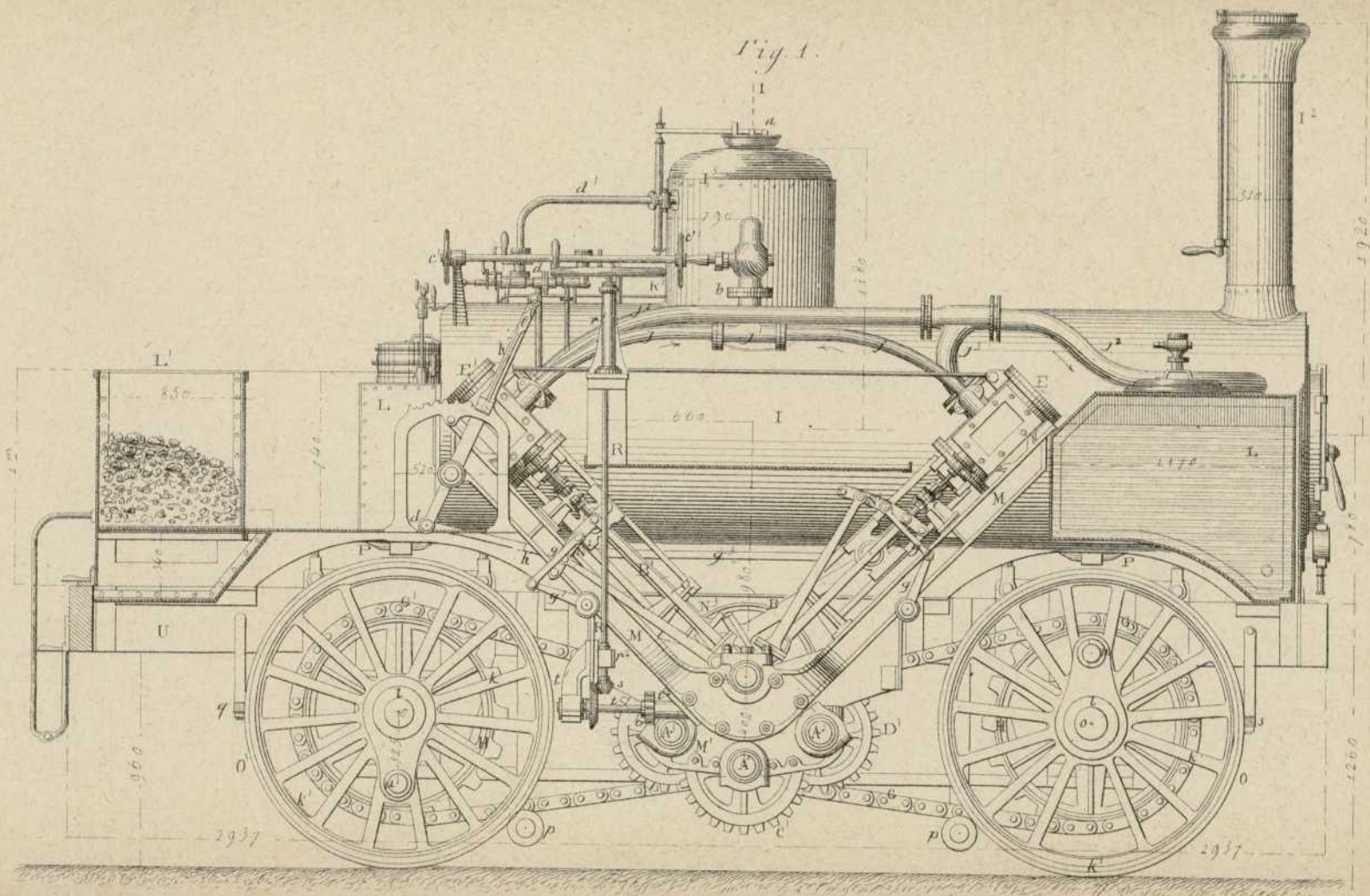
Fig. 4

Fig. 5



B





Escala de 1/30

R.

Fig. 4.

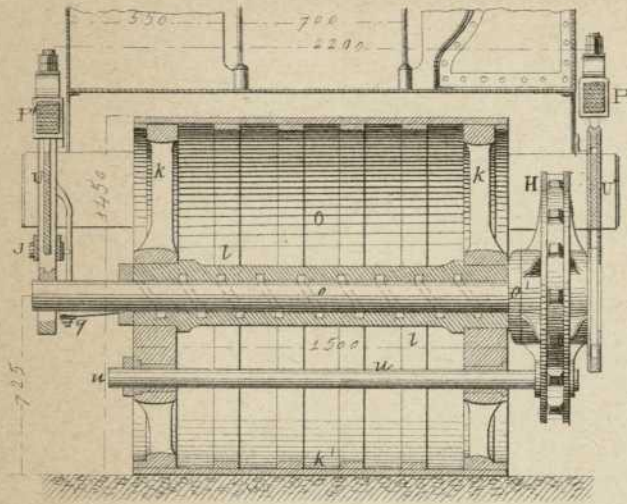


Fig. 3.

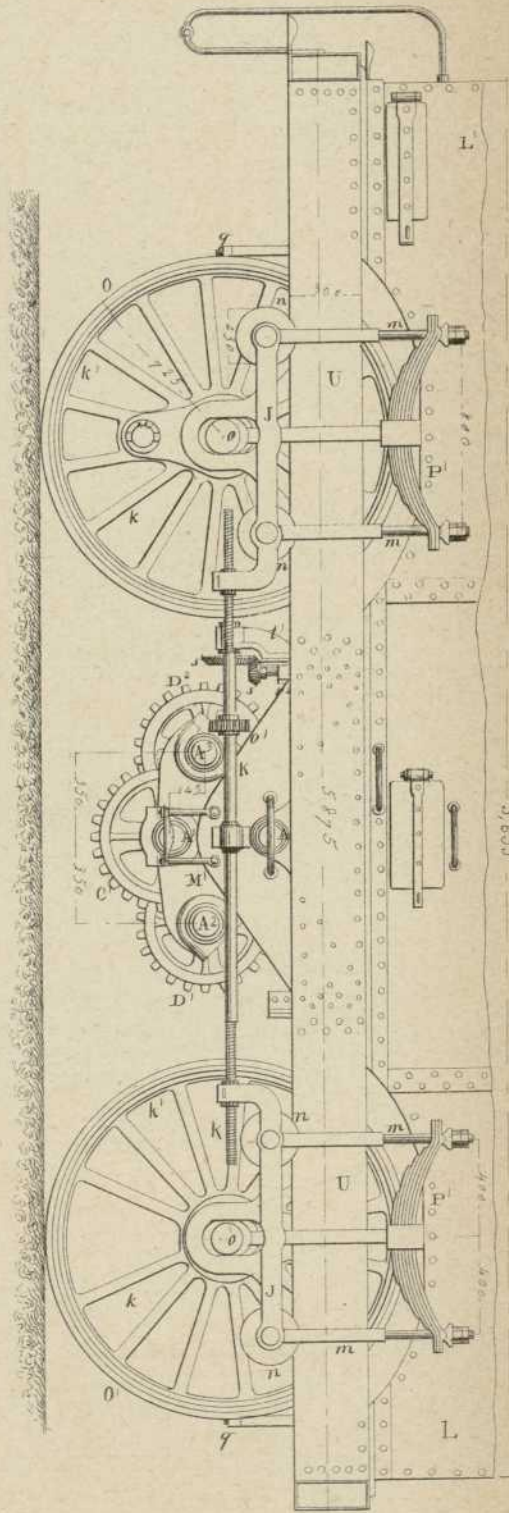
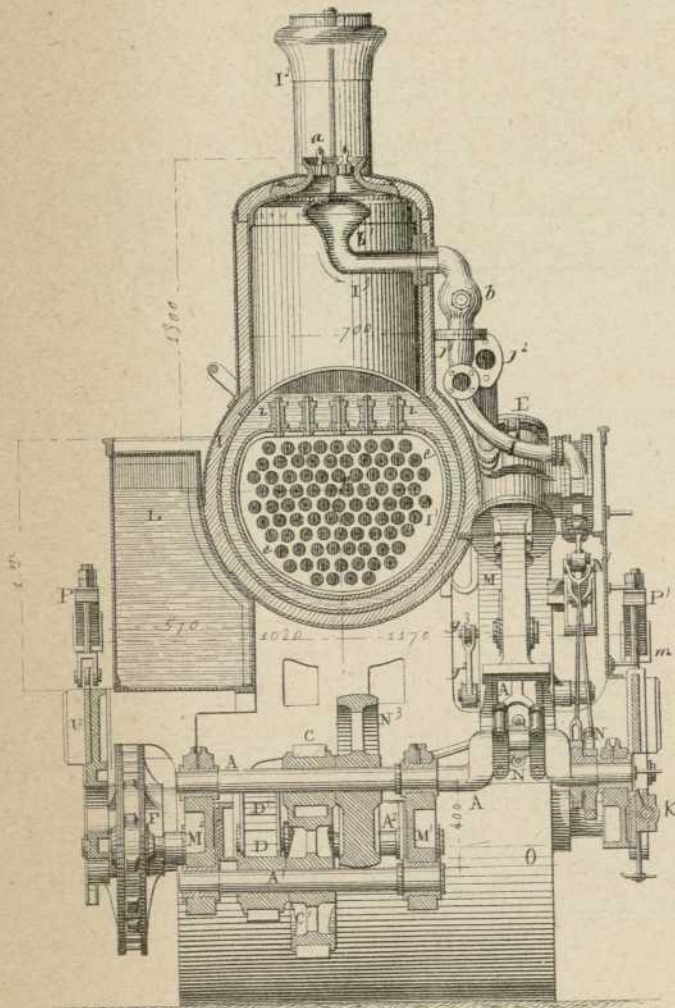
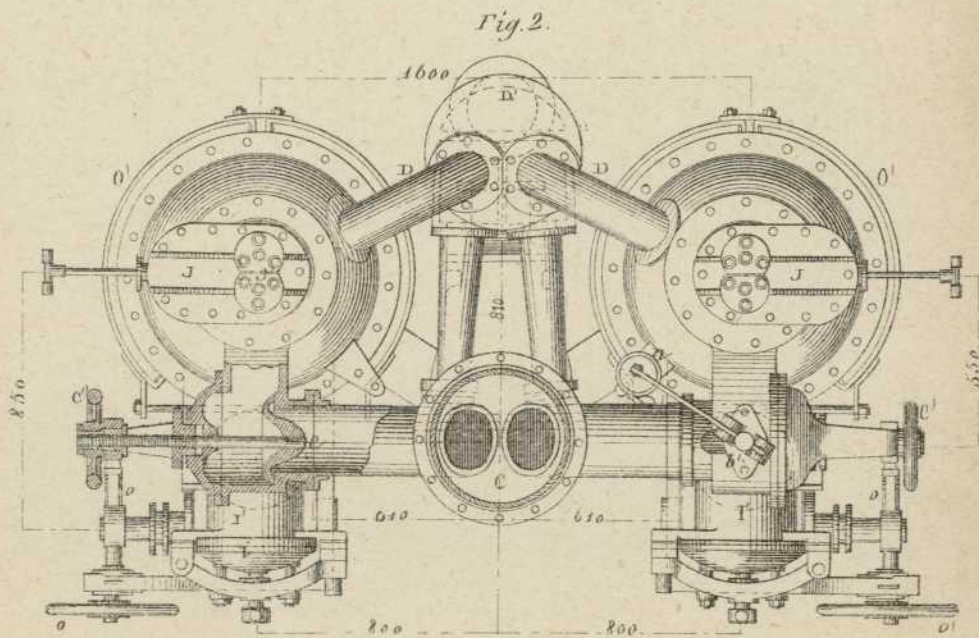
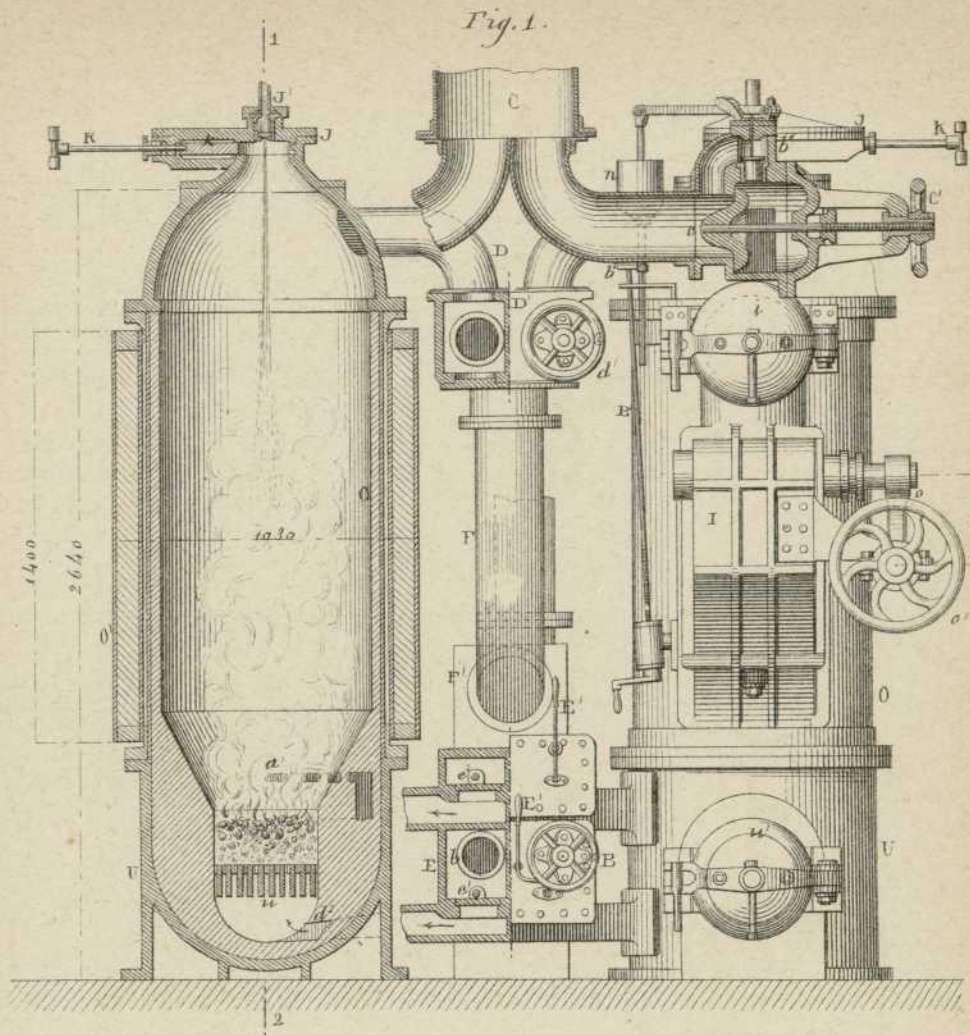
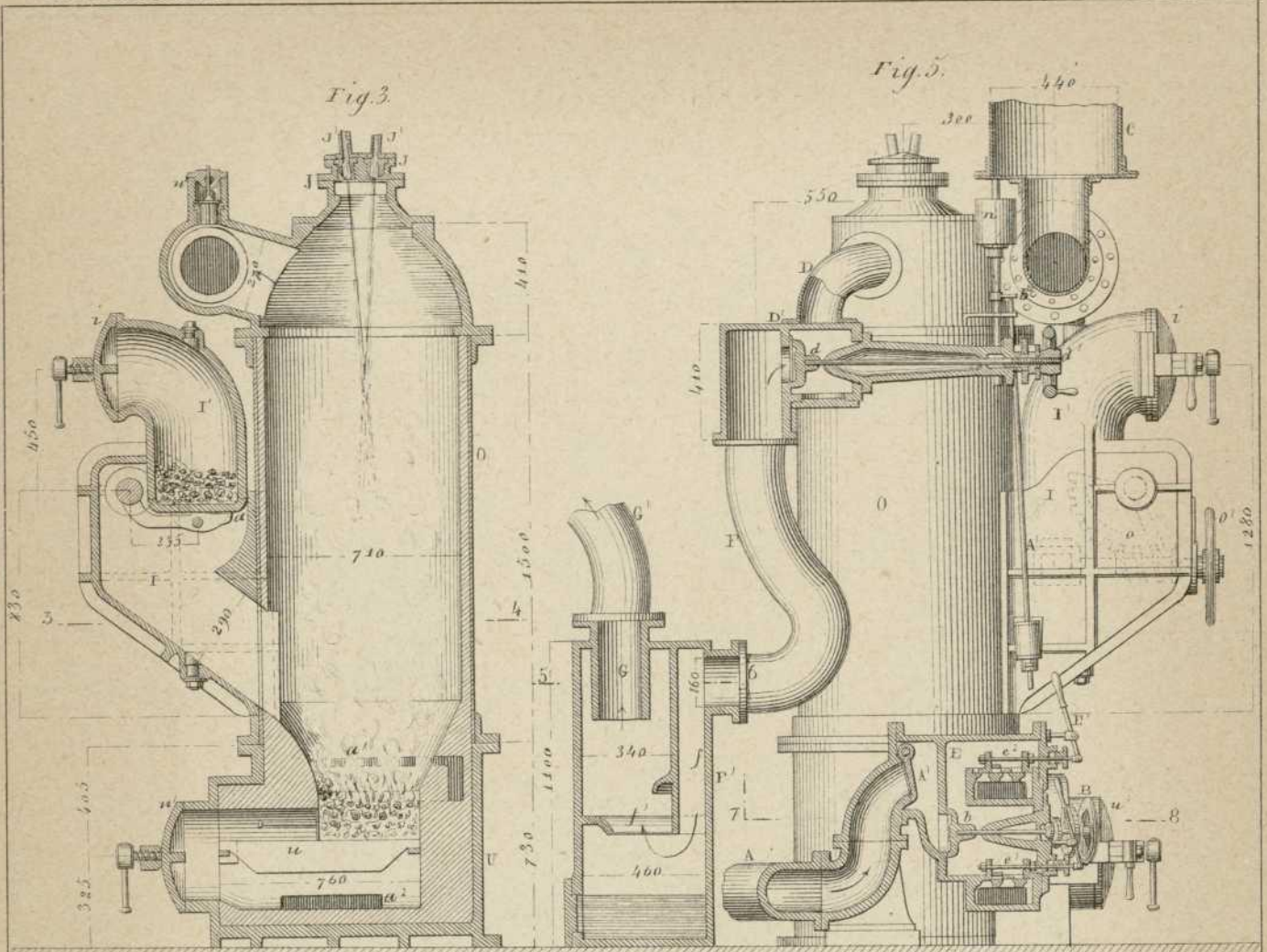


Fig. 2.

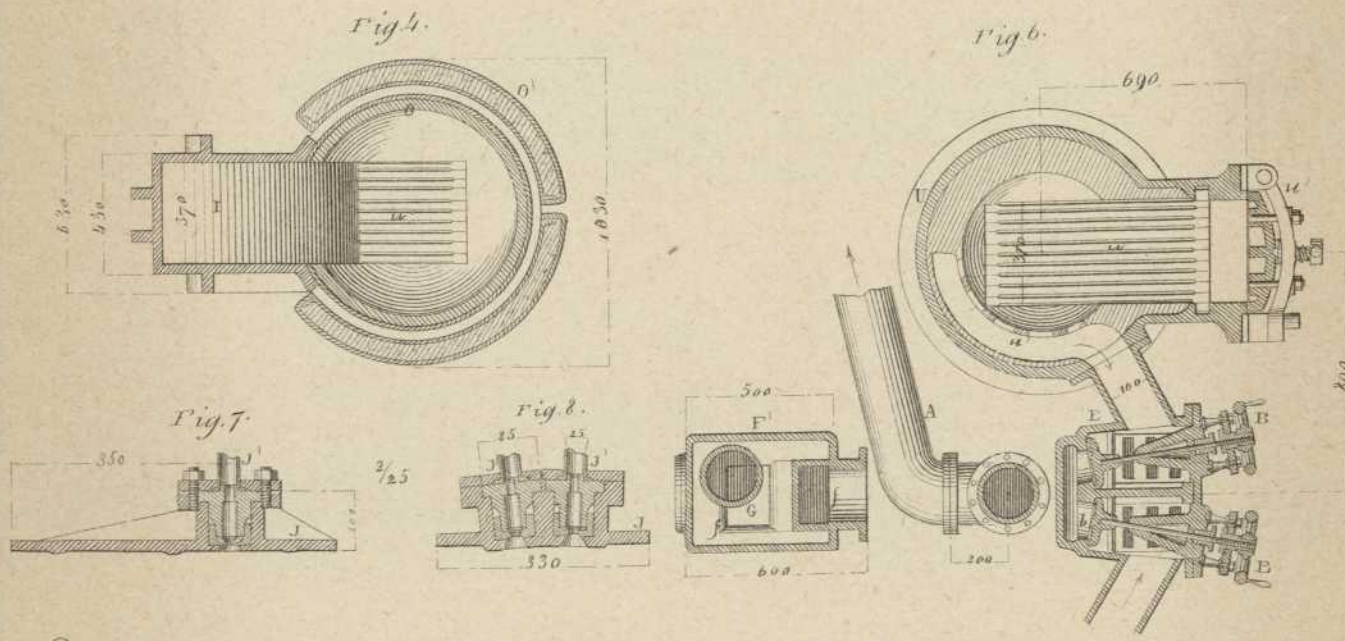


(B)



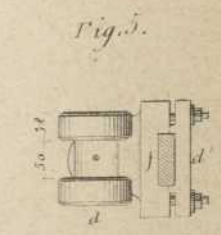
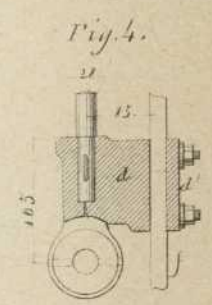
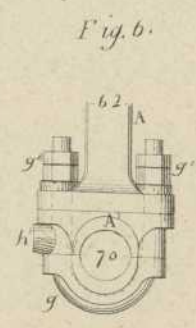
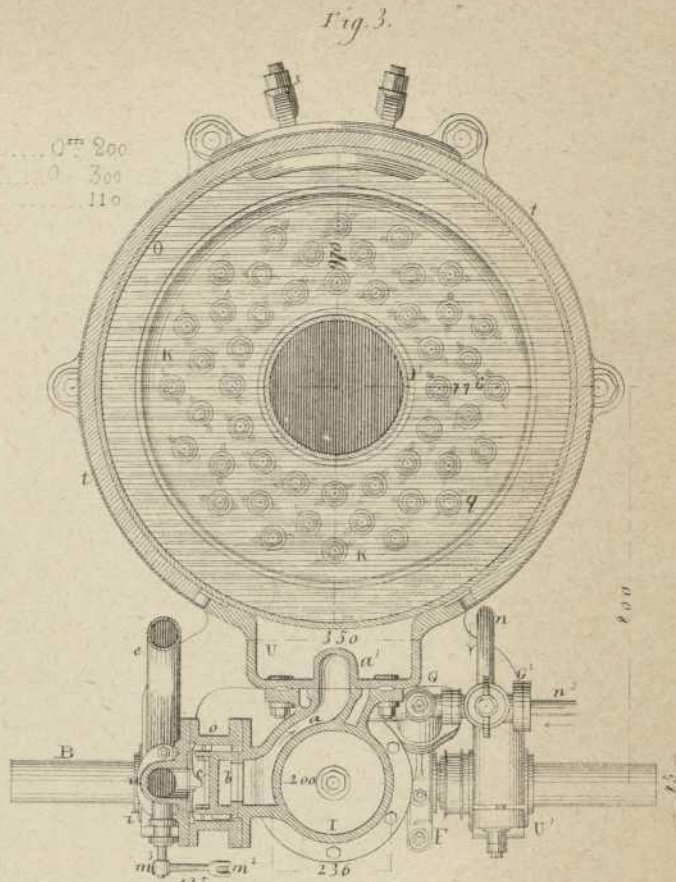
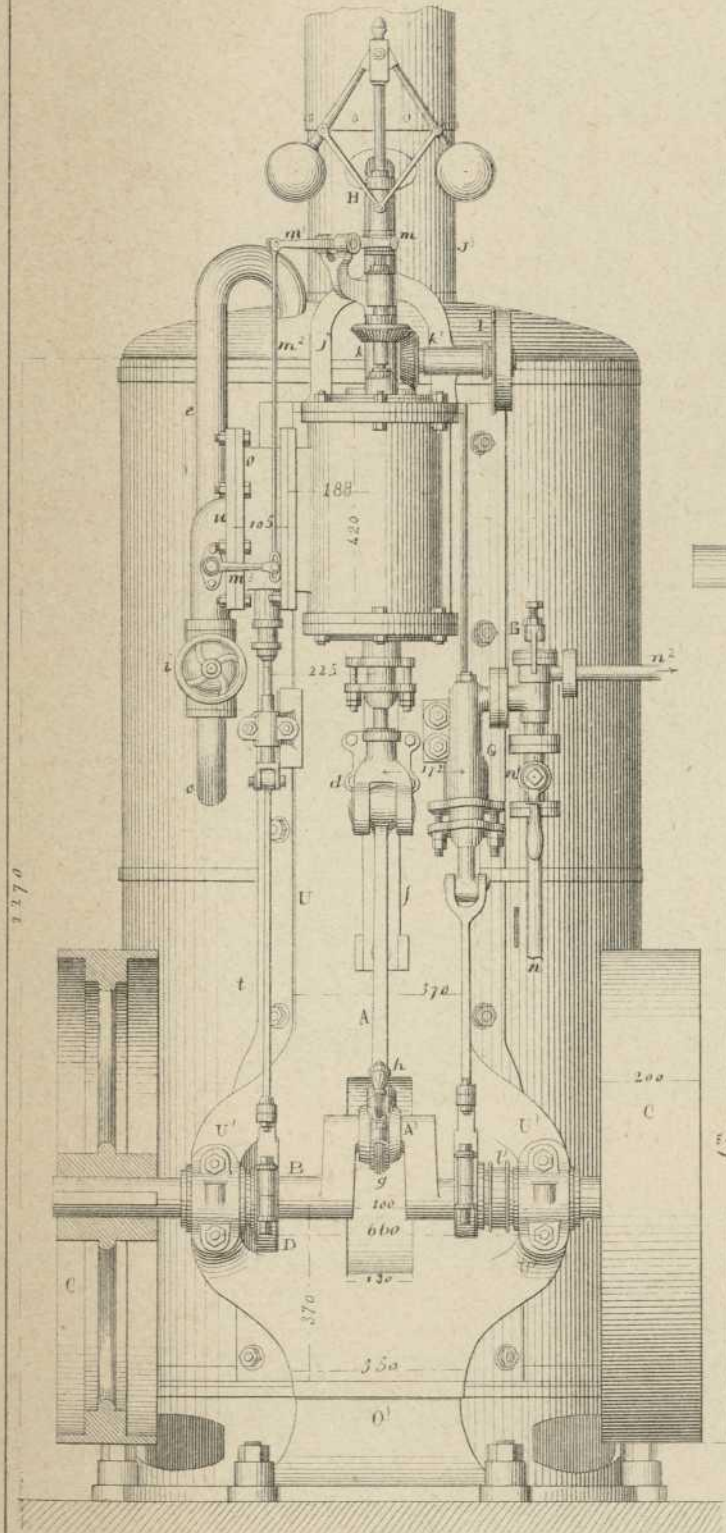


Escala de 1/25



B.

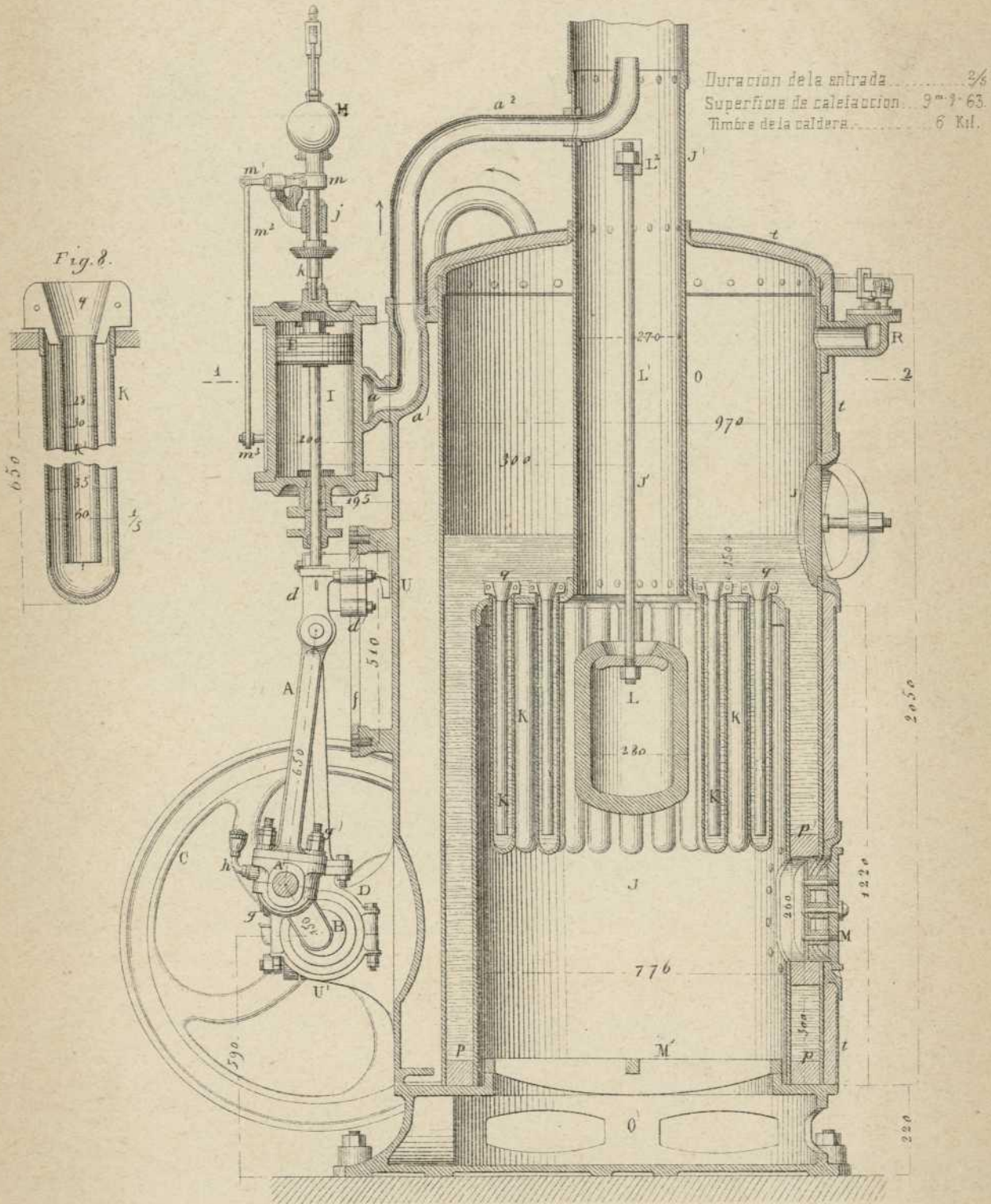
Fig. 1. Diámetro del émbolo 0^m 200
 Carrera 0 300
 Vueltas por minuto 110



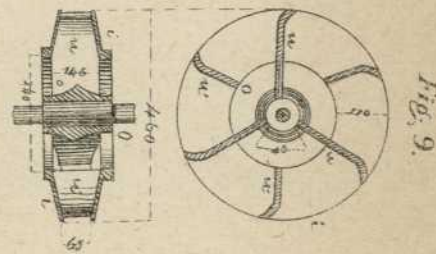
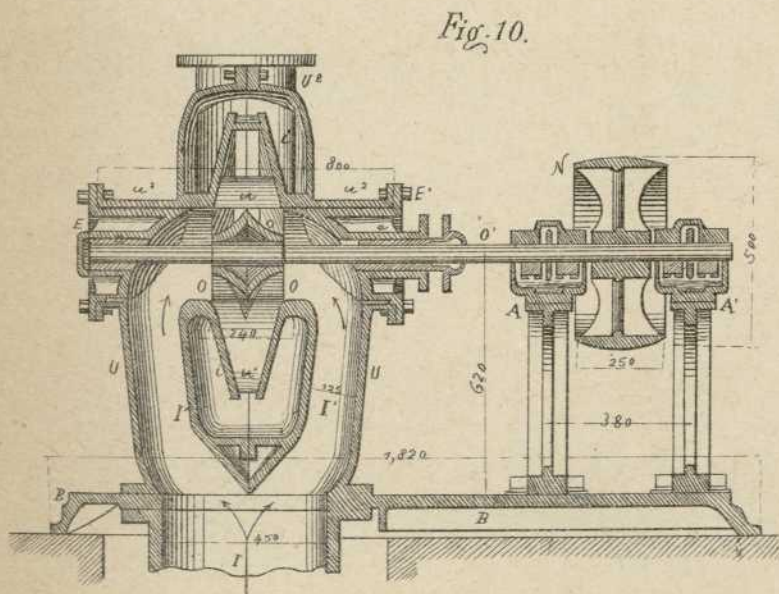
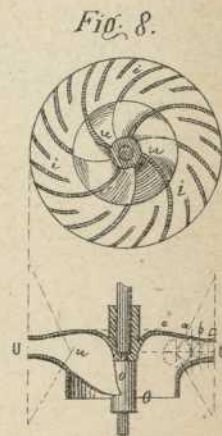
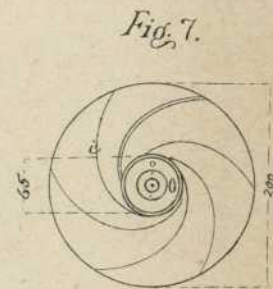
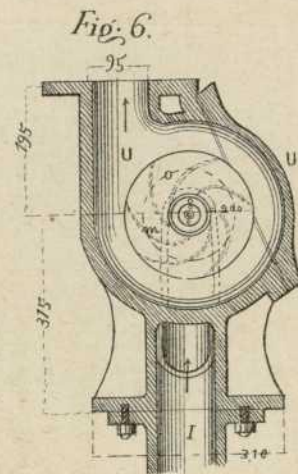
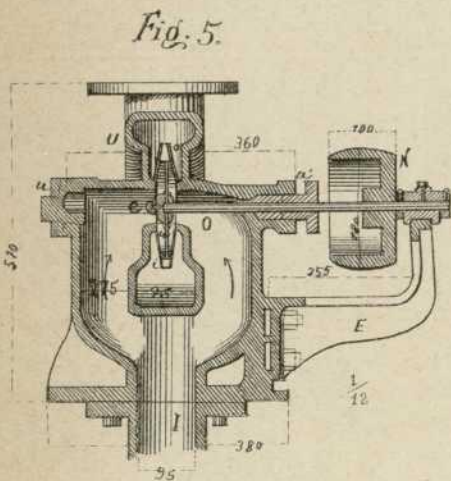
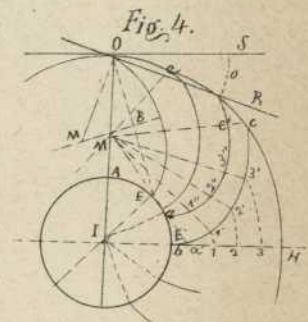
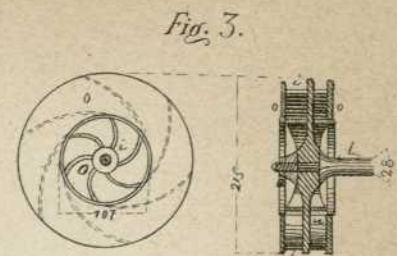
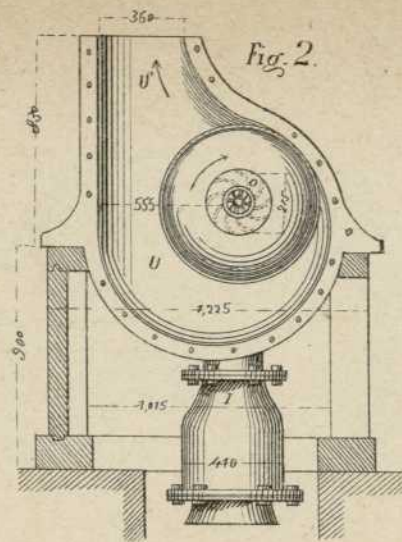
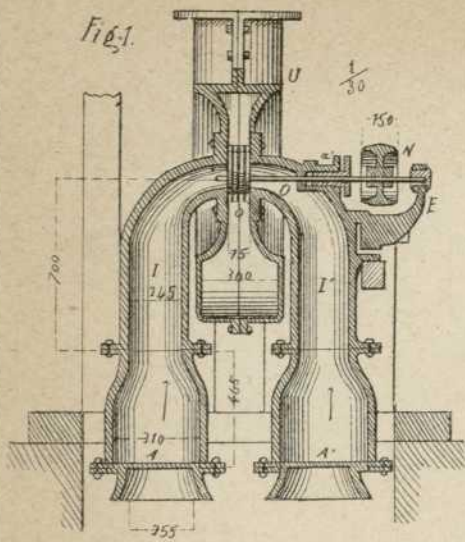
Escala de 1/10 por las Fig 1 a 3

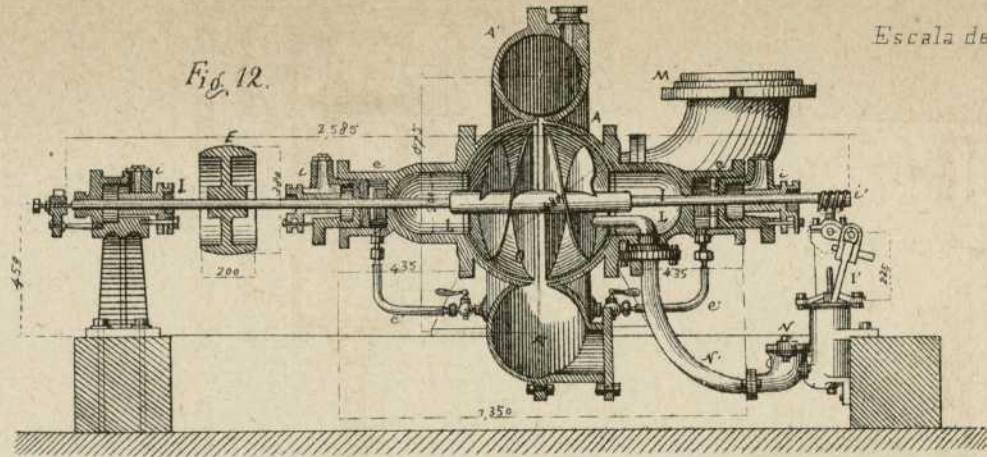
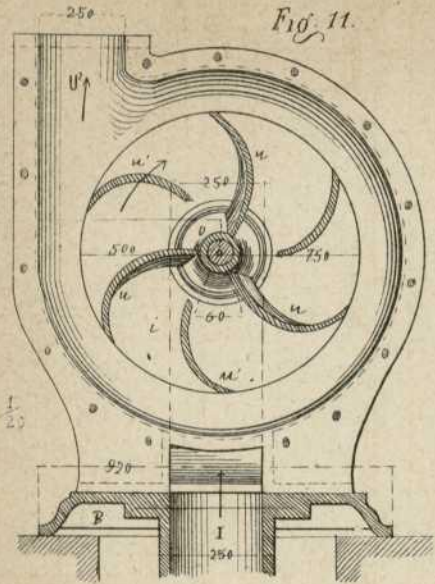
B.

Fig. 2.



Ar.





Escala de 1/25

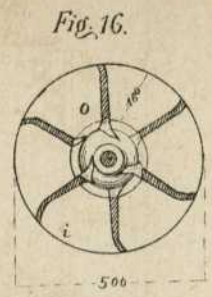


Fig. 14.

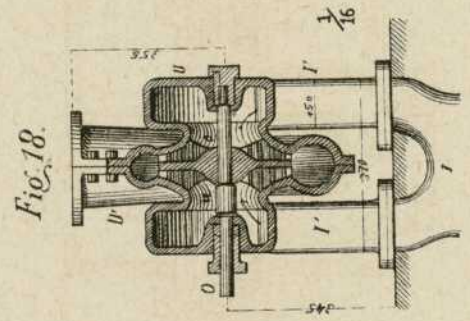
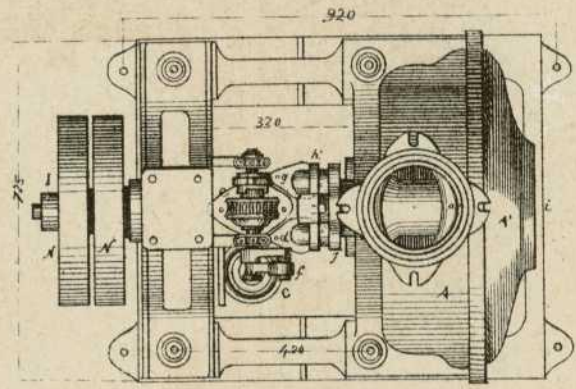


Fig. 18.

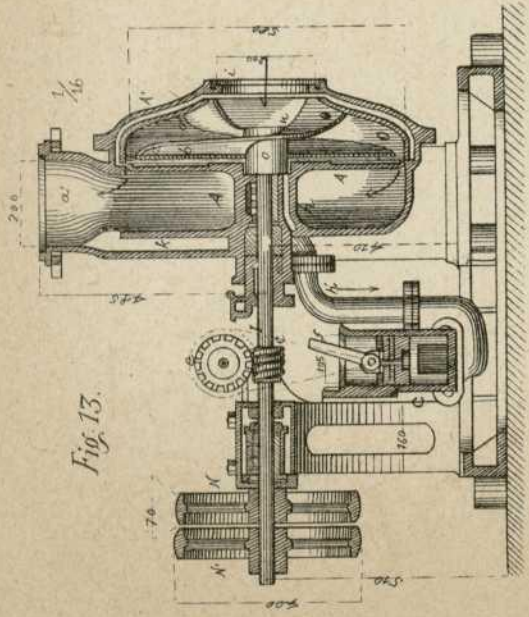


Fig. 13.

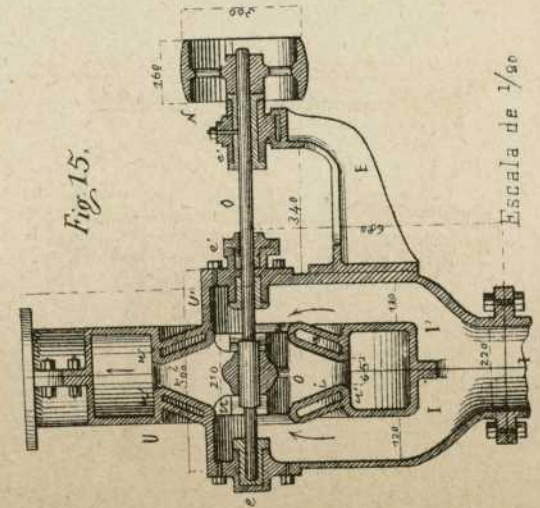


Fig. 15.

Escala de 1/50

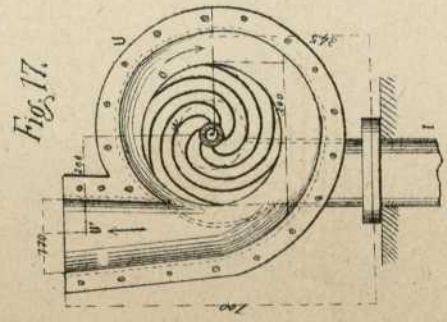


Fig. 17.

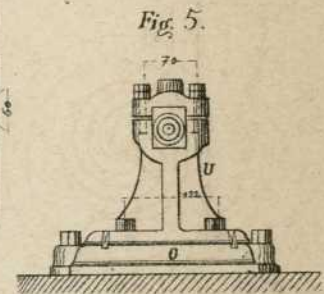
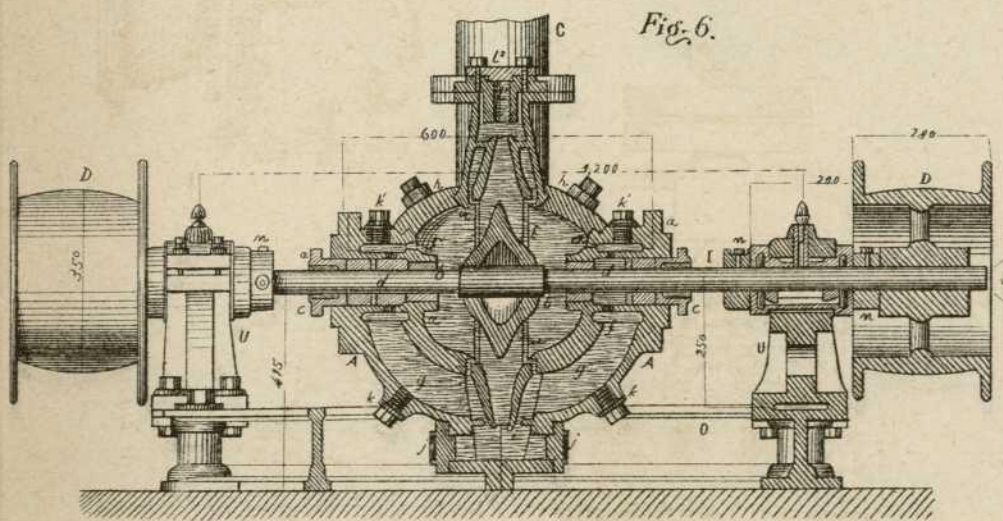
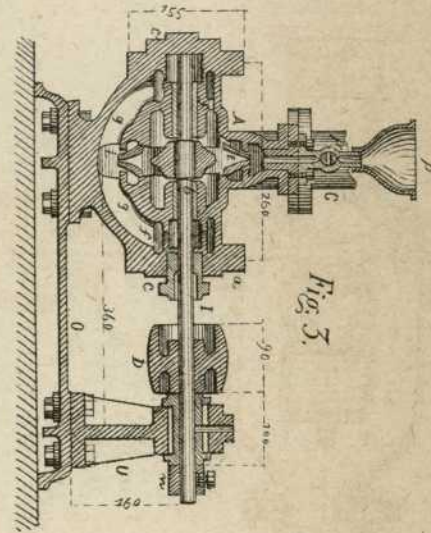
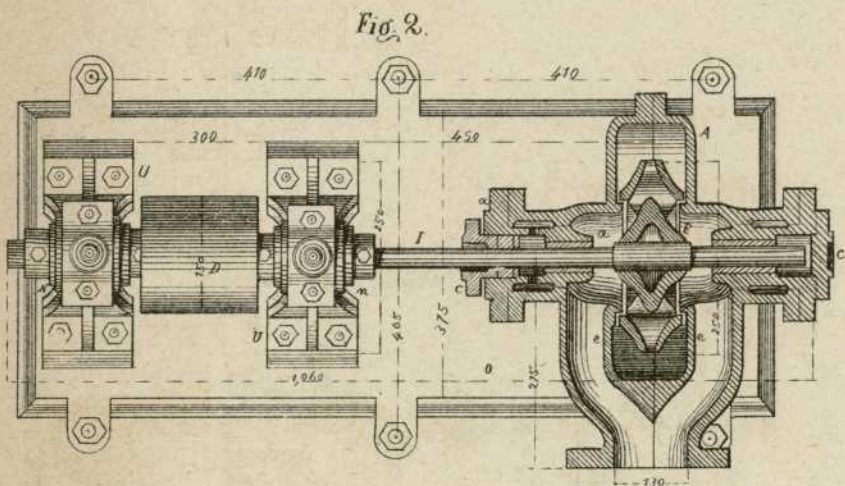
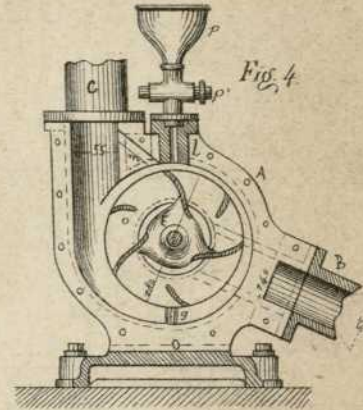
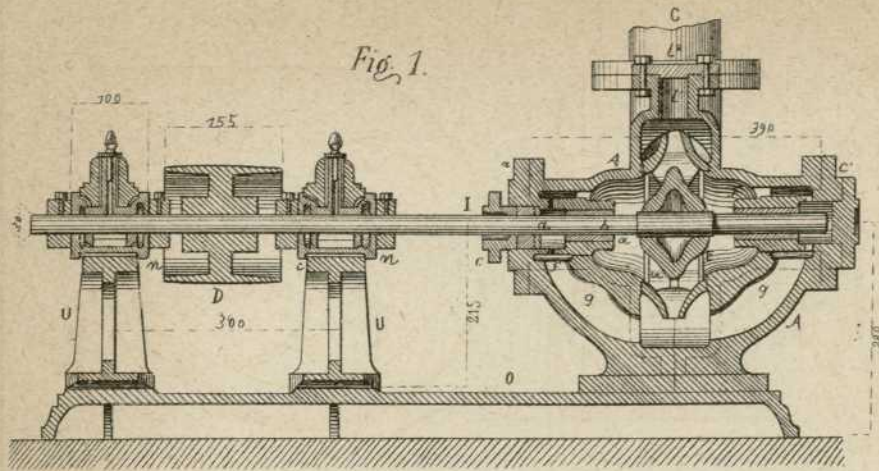


Fig. 7.

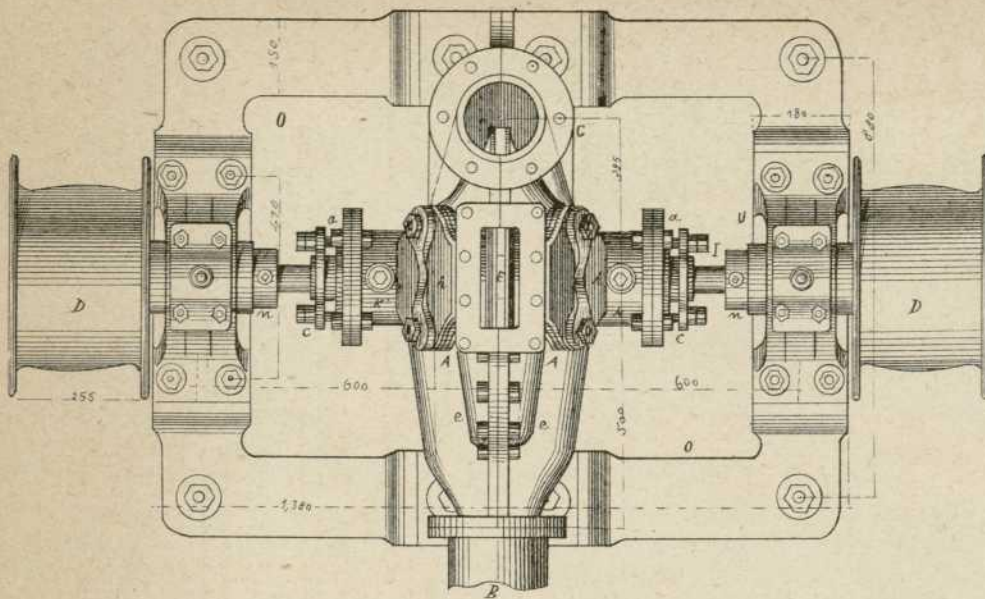


Fig. 11.

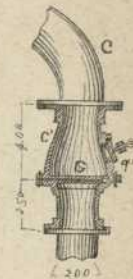


Fig. 12.

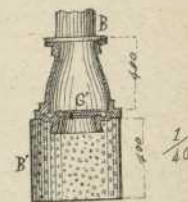


Fig. 13.



Fig. 8.

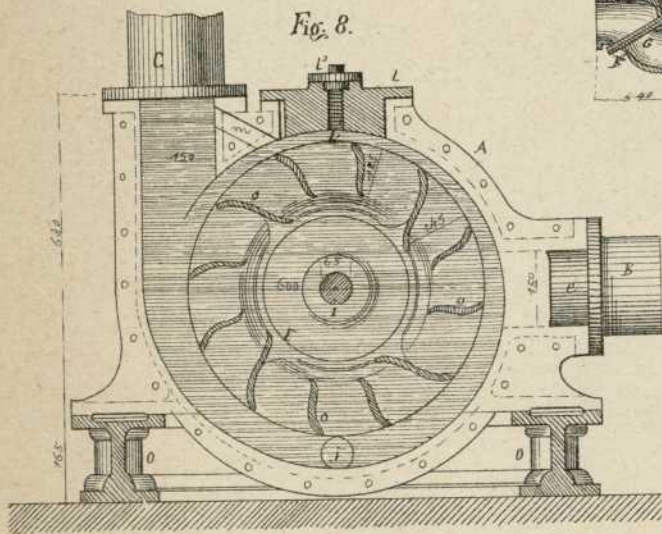


Fig. 9.

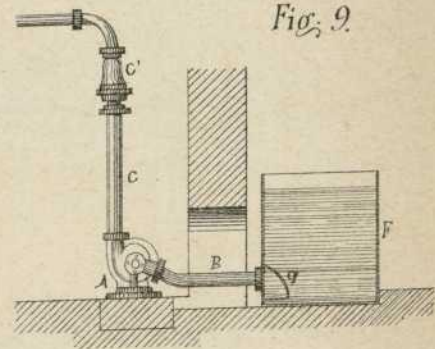


Fig. 10.



Escala de $\frac{1}{40}$ por las Fig. 1 à 5.
Escala de $\frac{1}{16}$ por las Fig. 6 à 8.

Fig. 5.

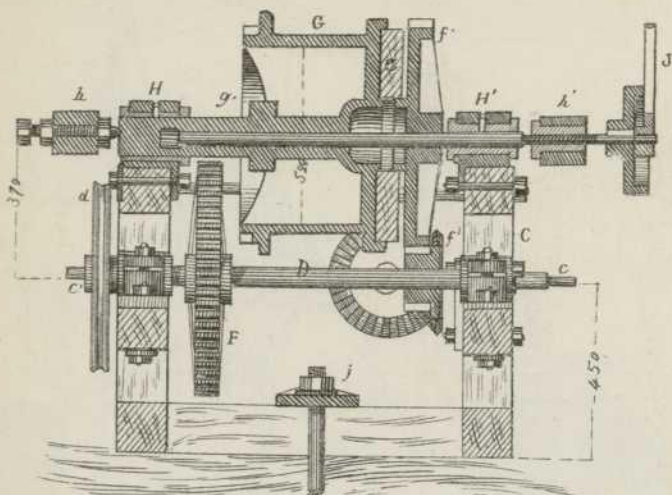


Fig. 10.

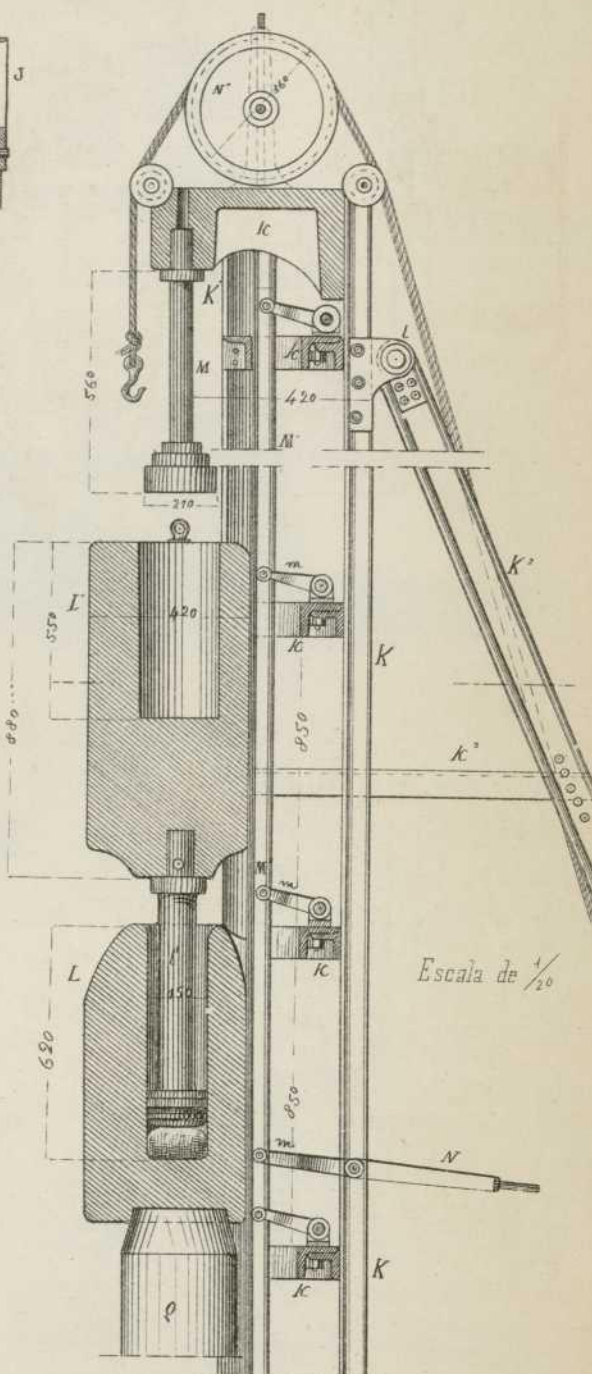


Fig. 6.

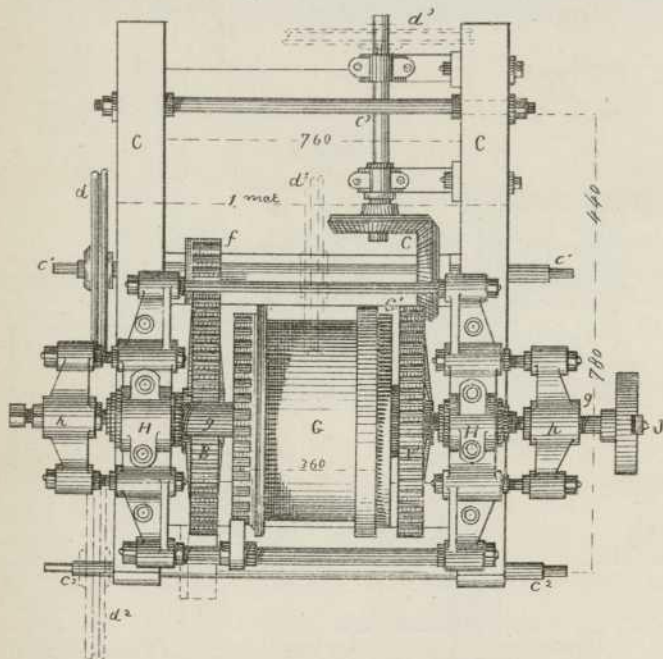


Fig. 9.

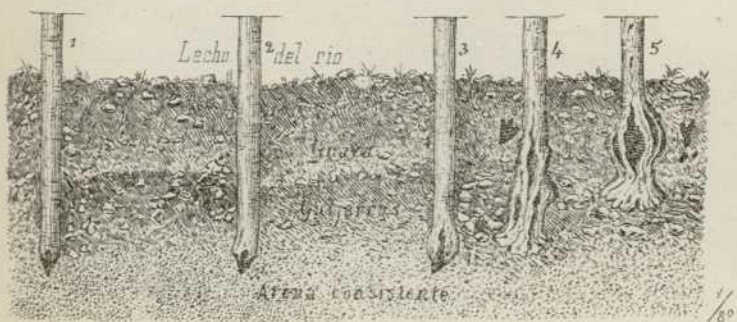
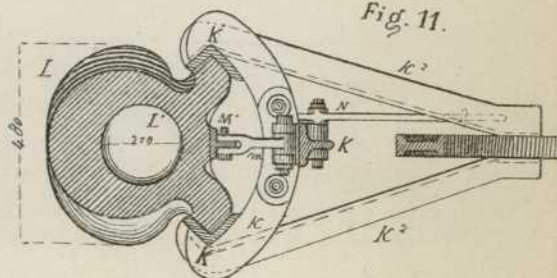
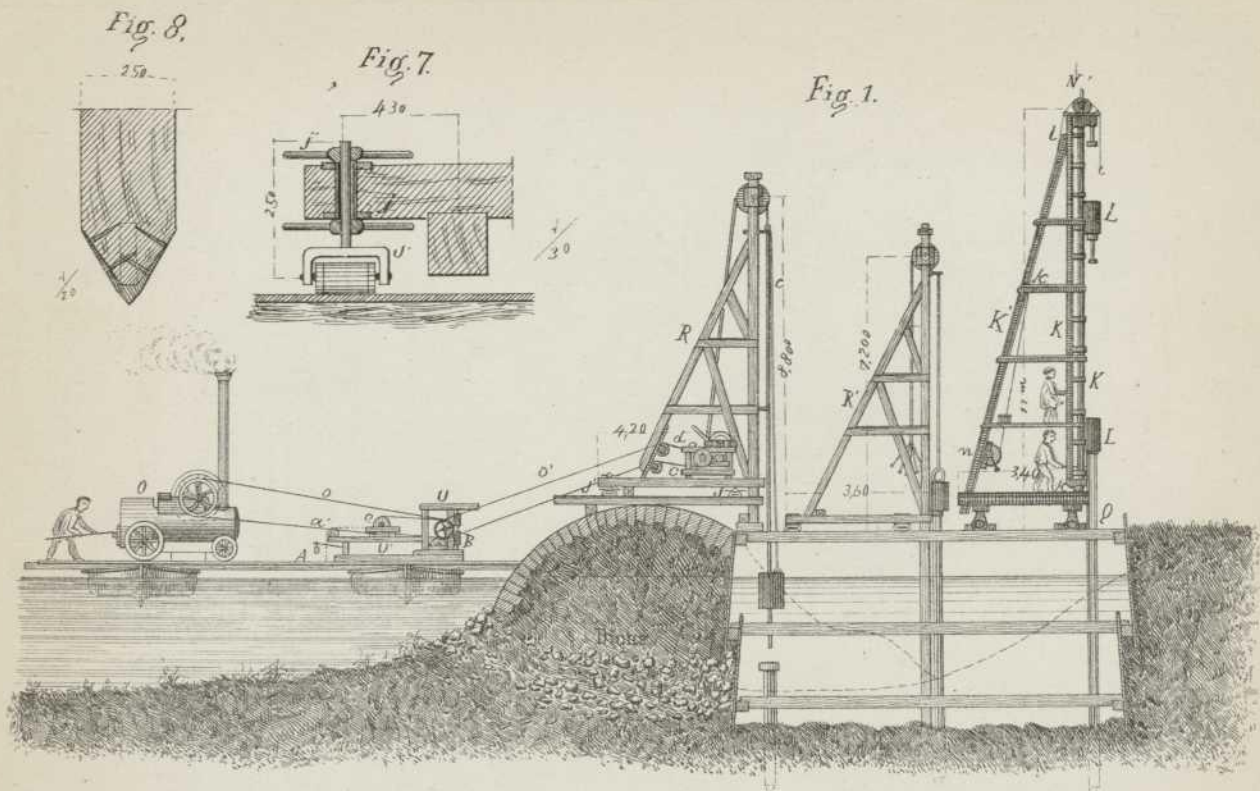
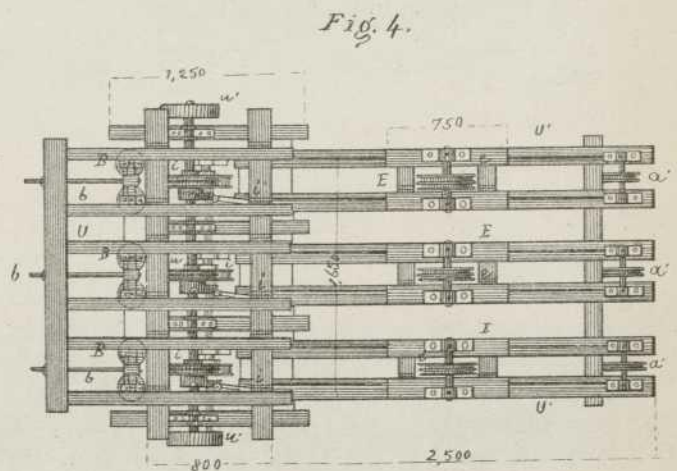
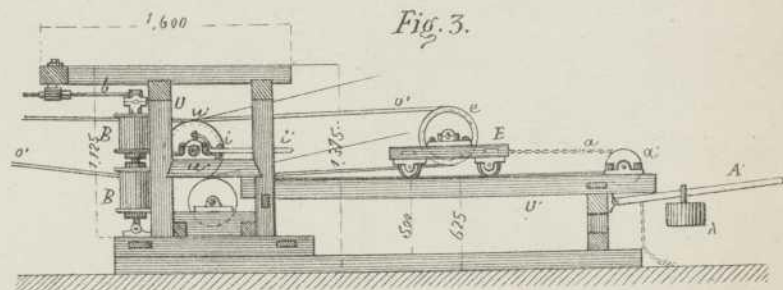
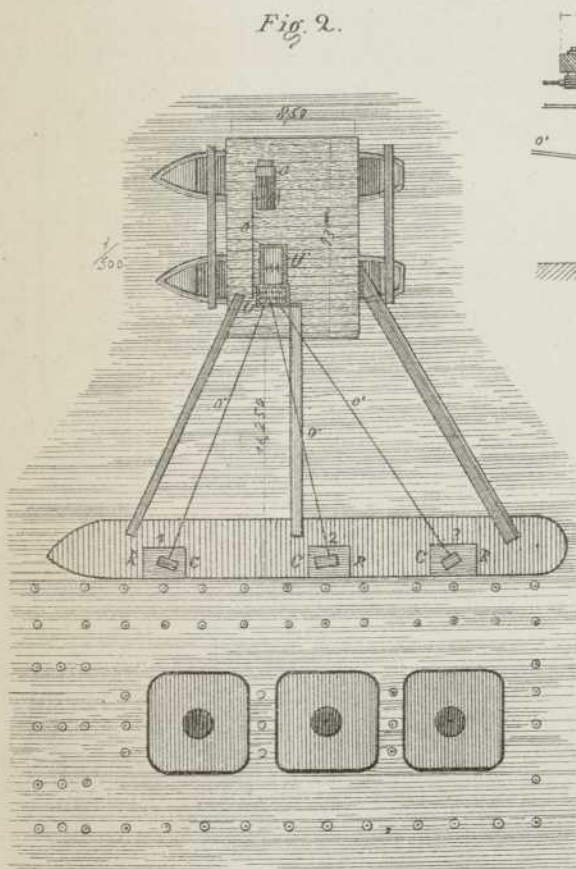


Fig. 11.





Escala de $\frac{1}{200}$



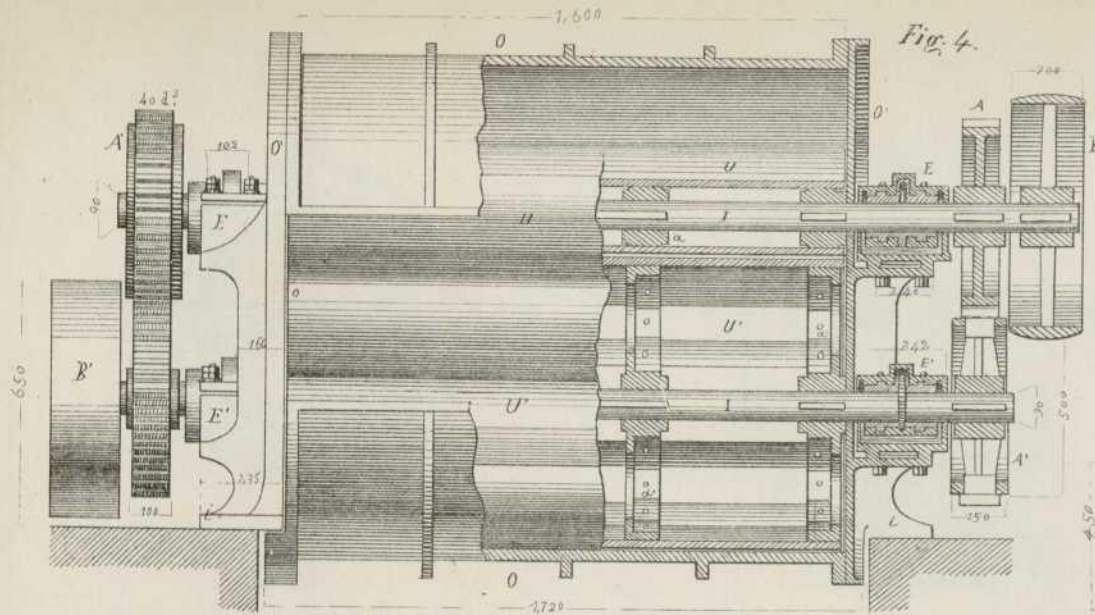


Fig. 4.

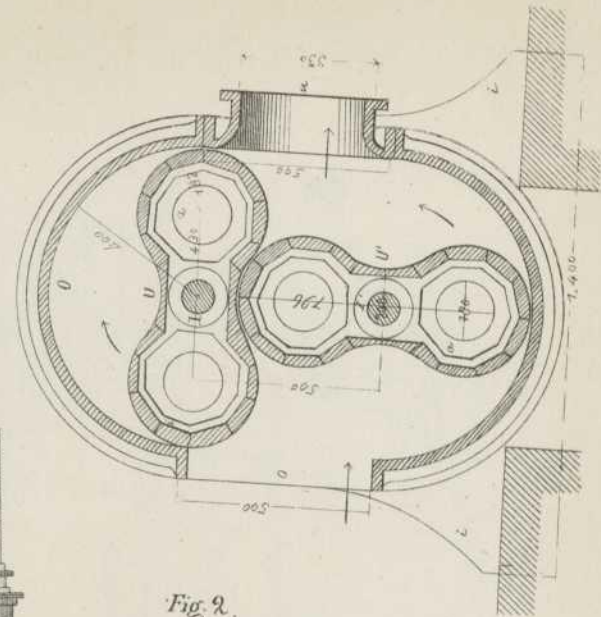


Fig. 3.

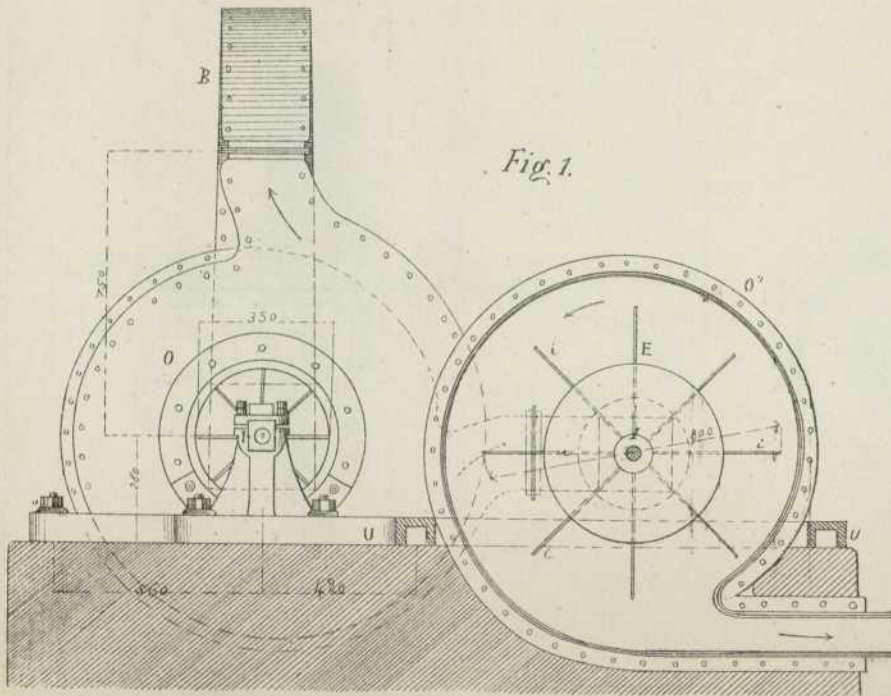


Fig. 1.

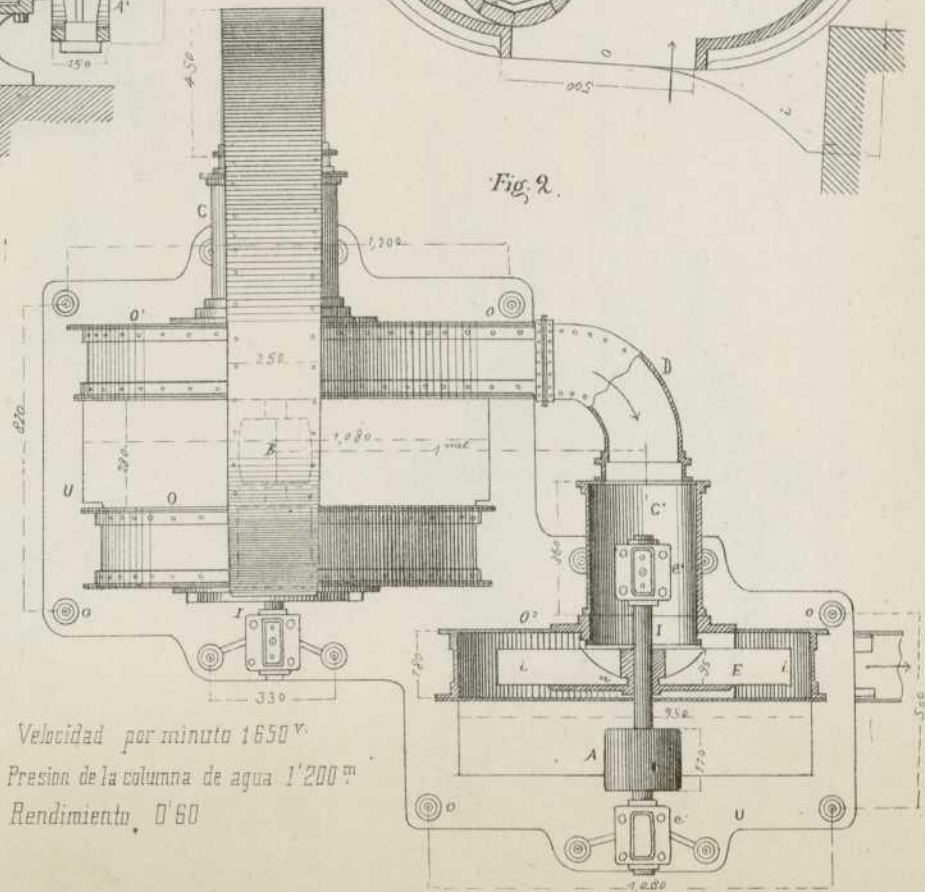


Fig. 2.

Velocidad por minuto 1650^v
Presion de la columna de agua 1'200^m
Rendimiento, 0'60

Fig. 5.

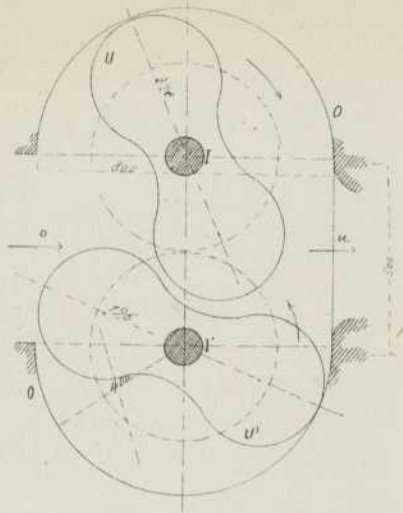


Fig. 6.

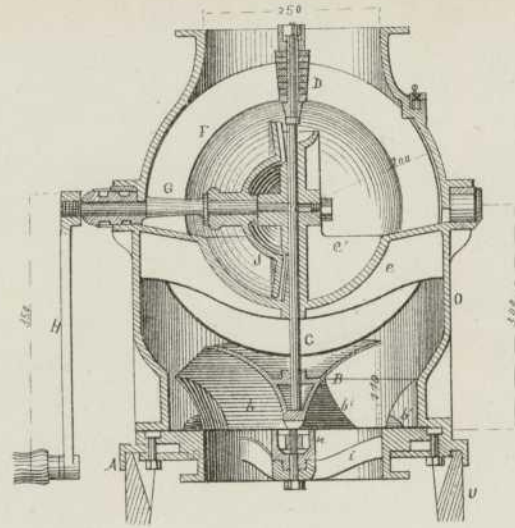


Fig. 7.

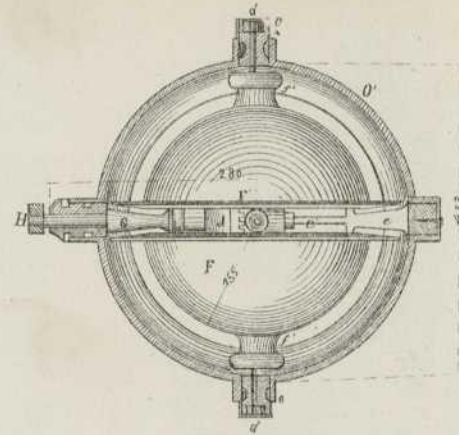


Fig. 8.

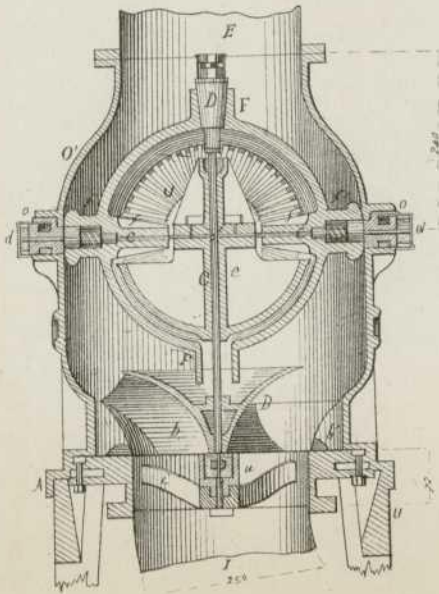


Fig. 9.

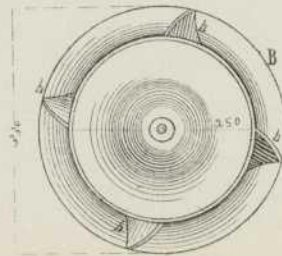
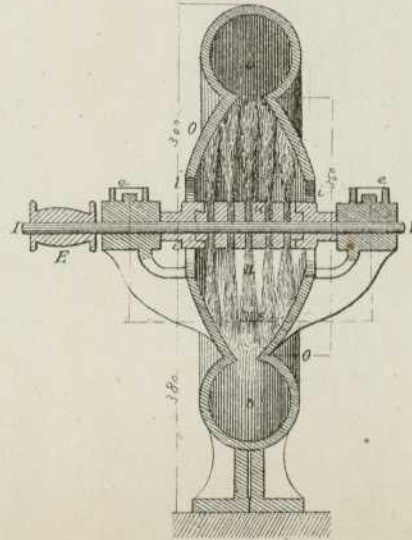
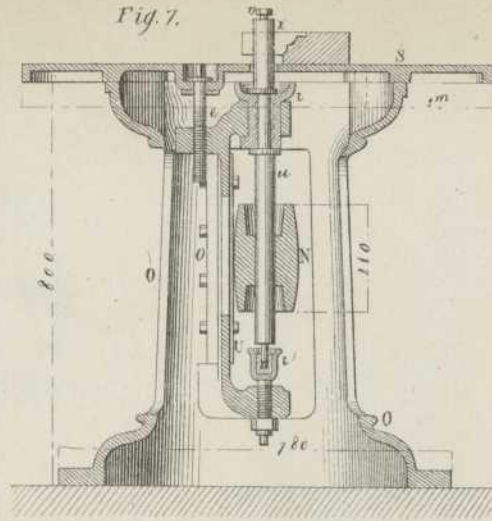


Fig. 10.



Escala de $\frac{1}{20}$ por las fig. 1 & 5
 Escala de $\frac{1}{10}$ por las fig. 6 & 10
 15 dec.²
 10 dec.²



Escala de $\frac{1}{20}$ por las fig.^s 1 a 4

Fig. 2.

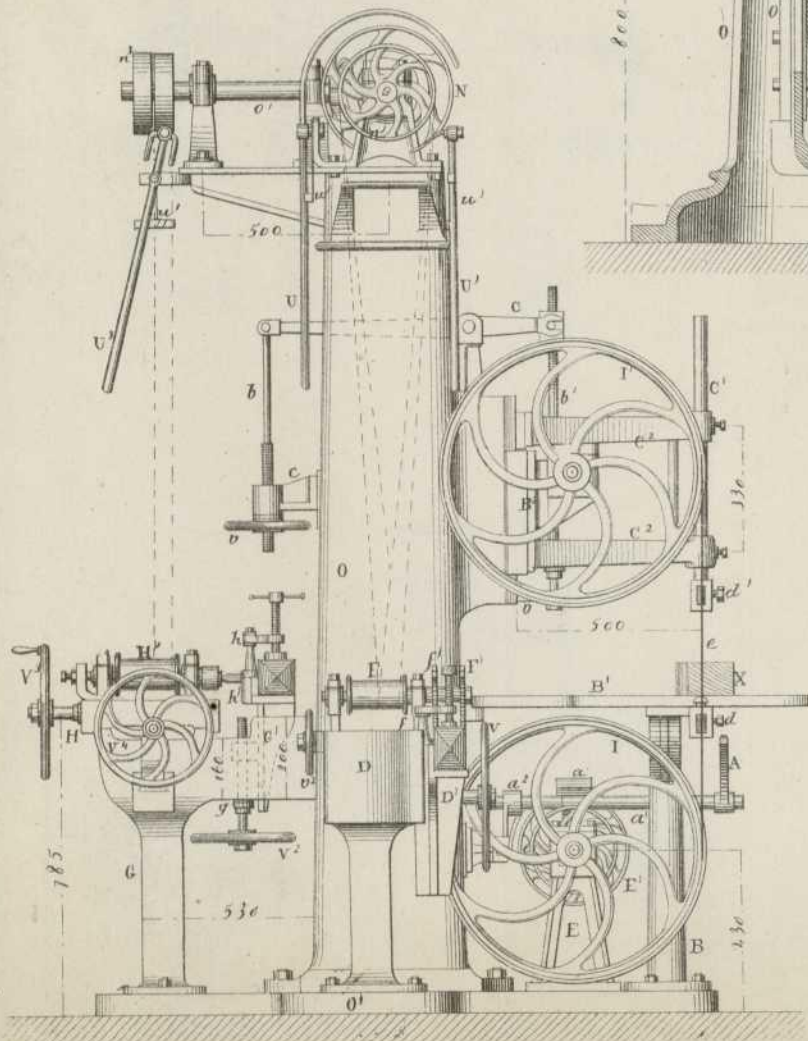


Fig. 5.

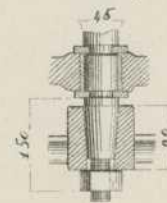
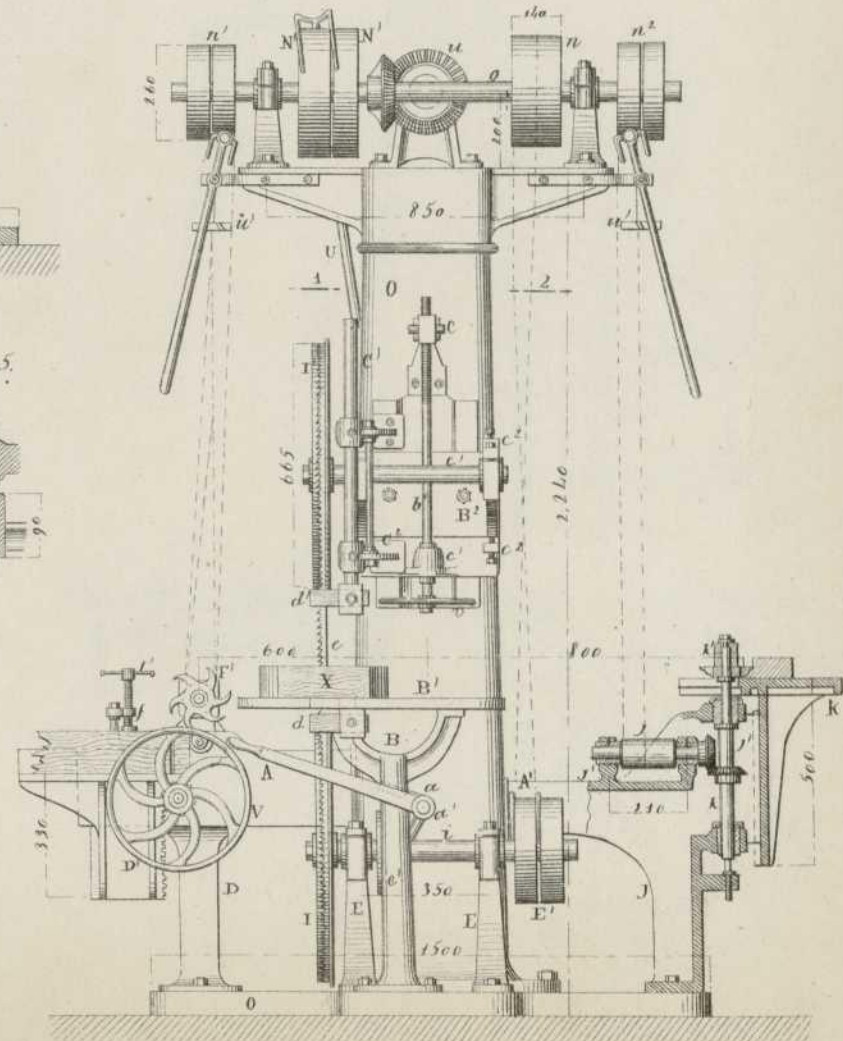
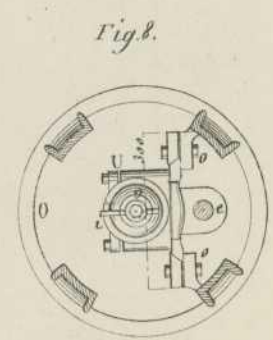
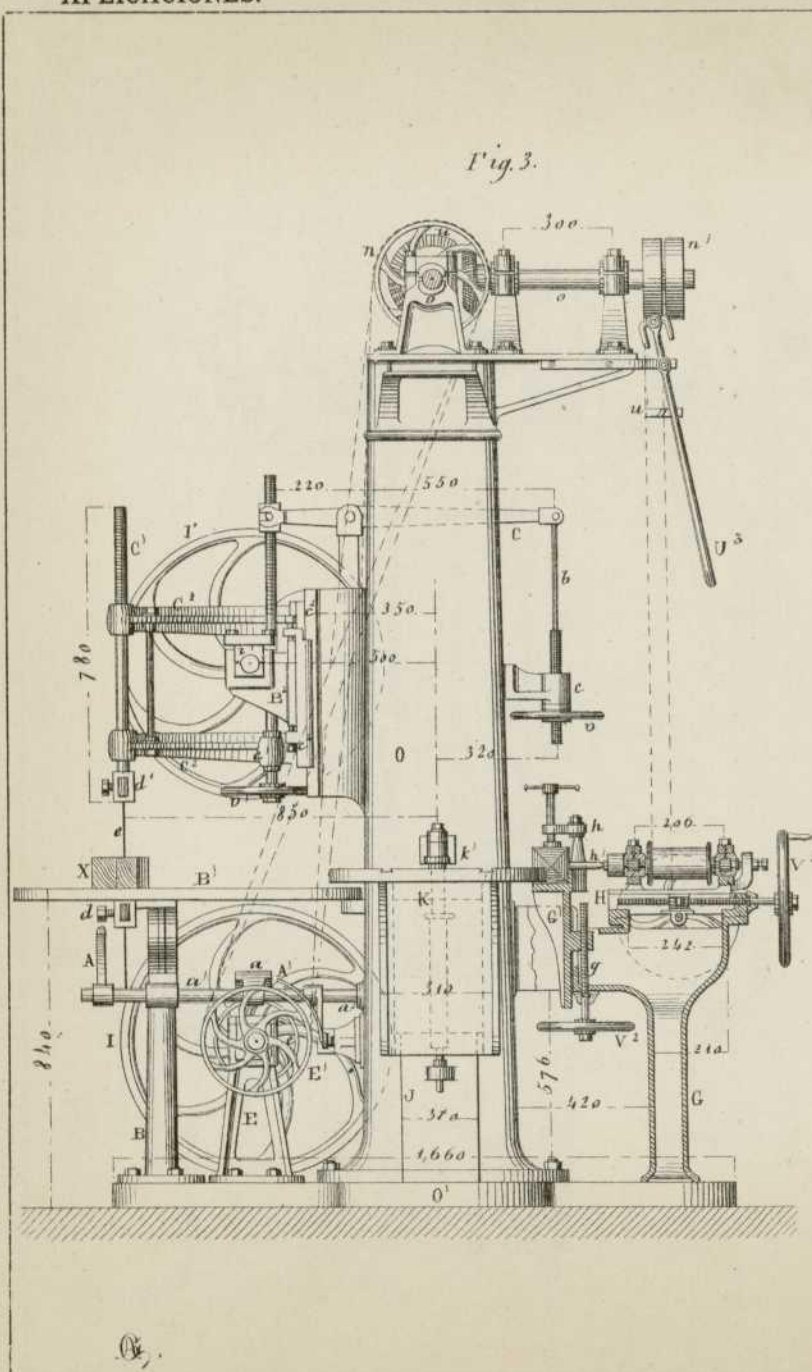


Fig. 6.

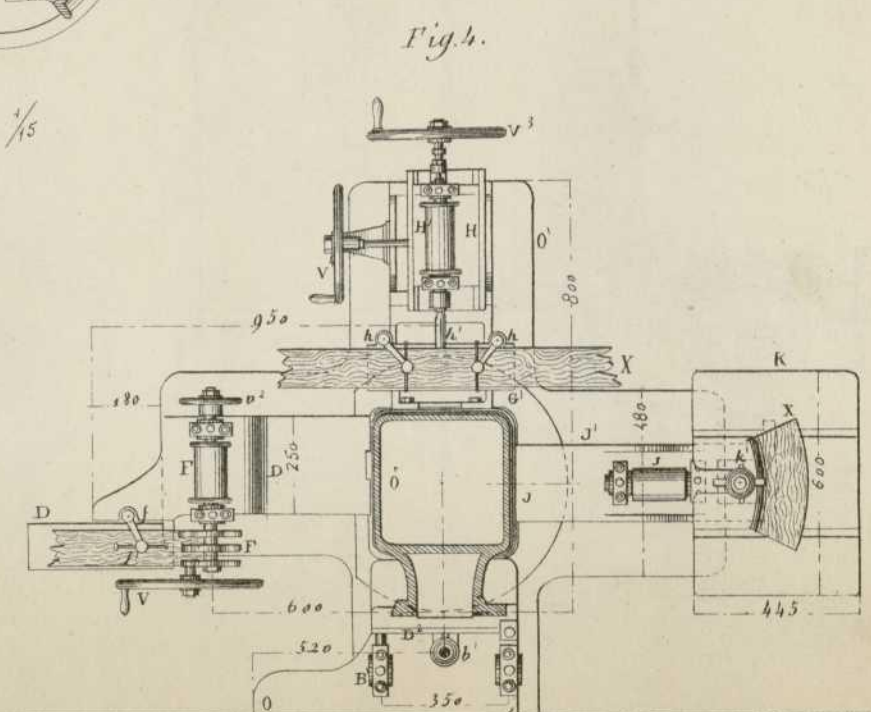
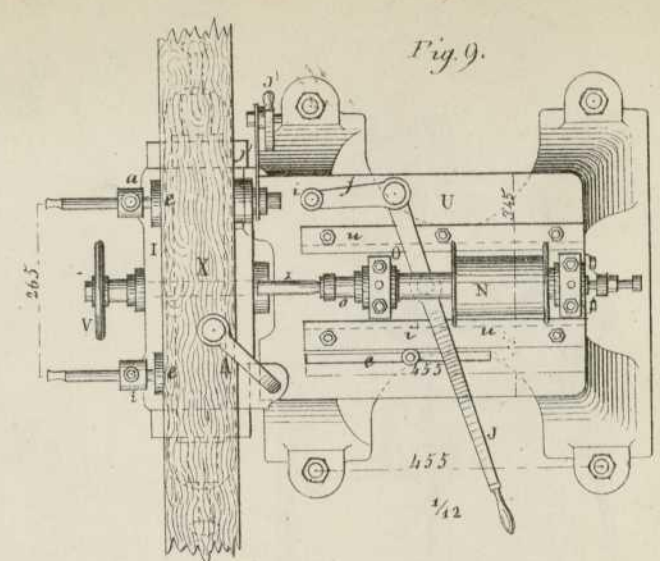


Fig. 1.





Escala de 1/5



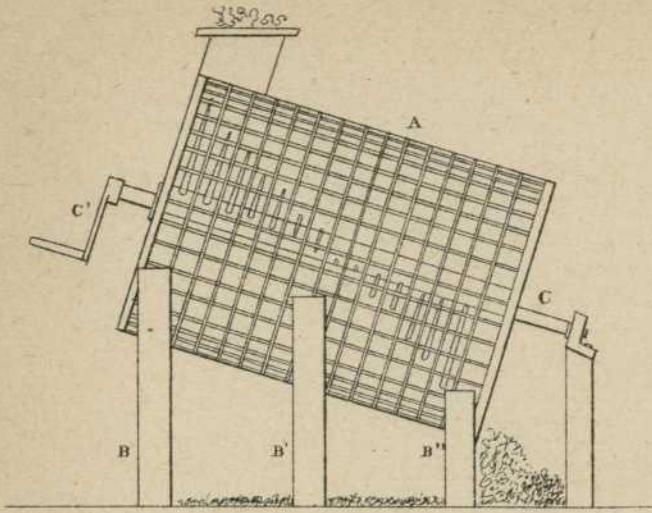


Fig. 1.

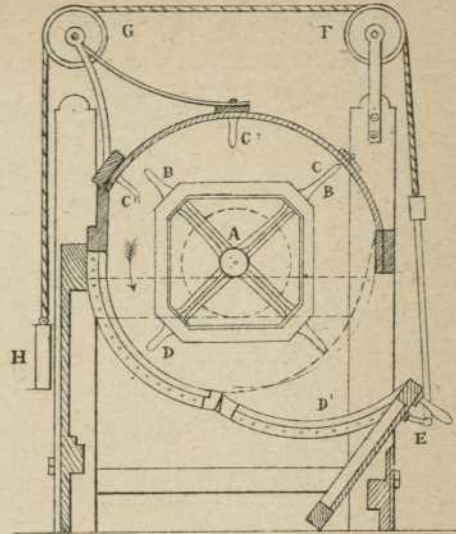


Fig. 2.

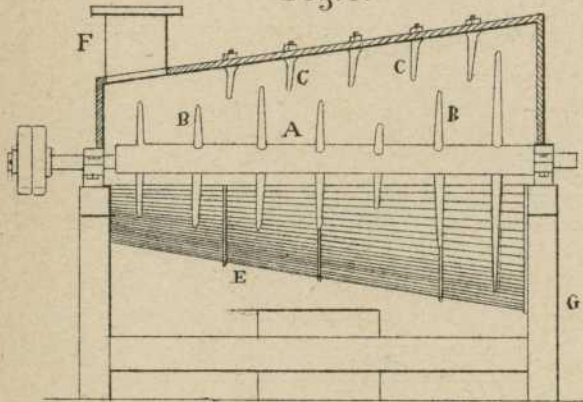


Fig. 3.

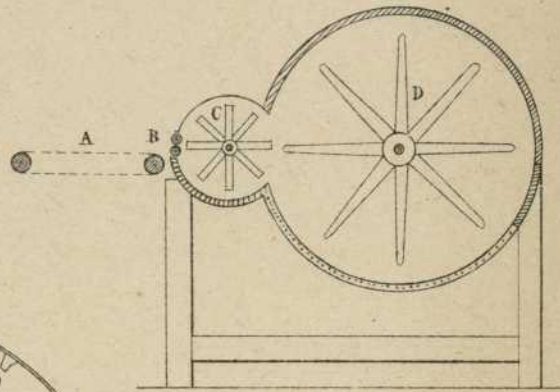


Fig. 4.

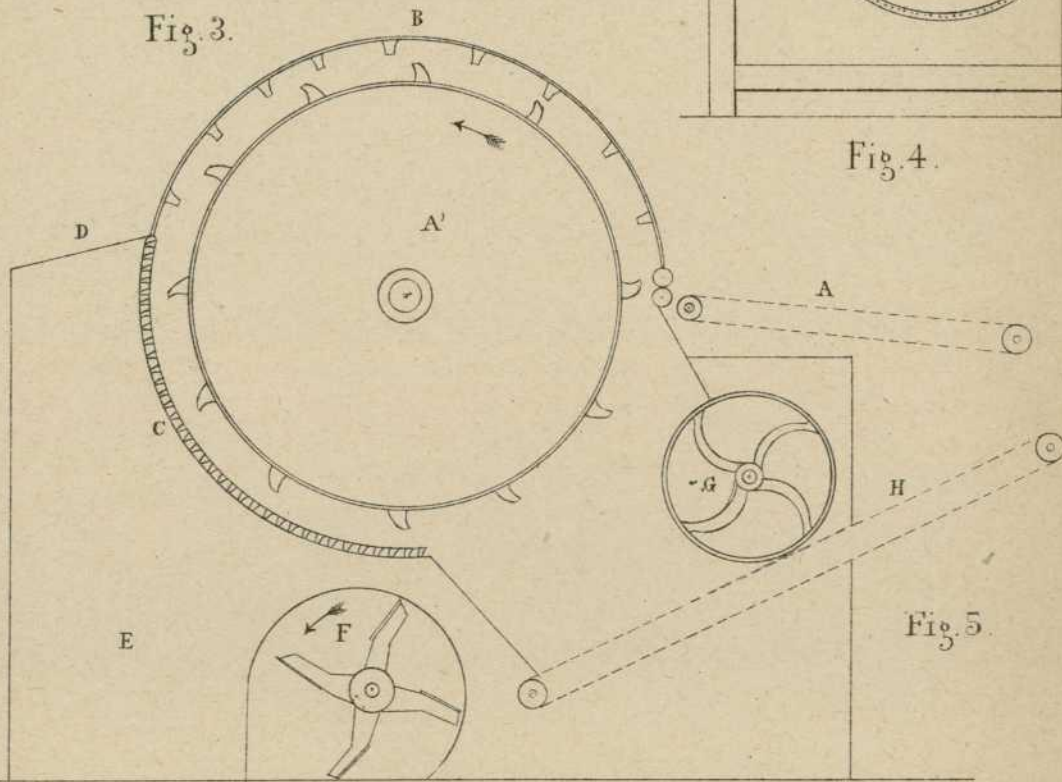


Fig. 5.

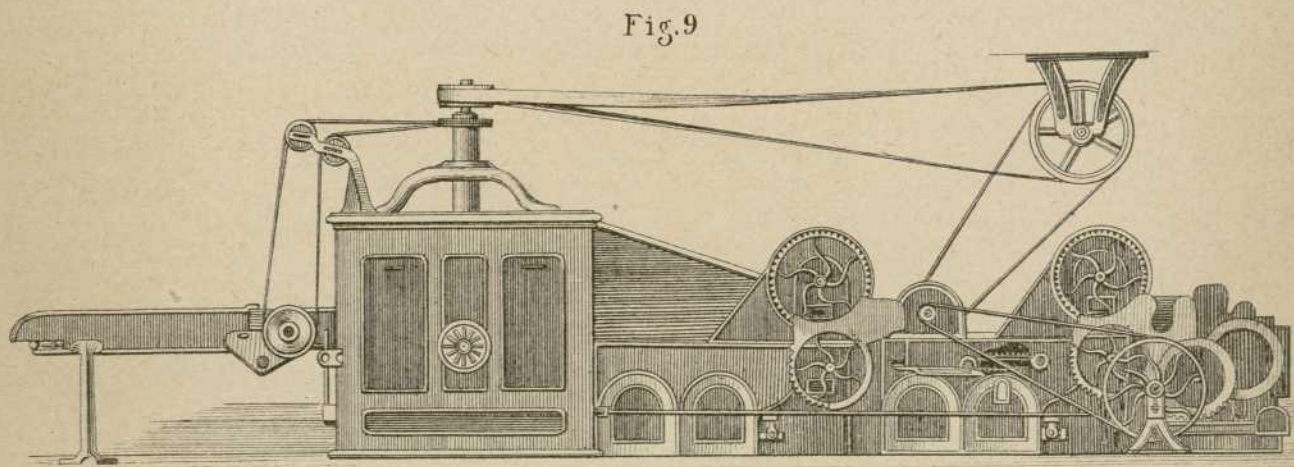
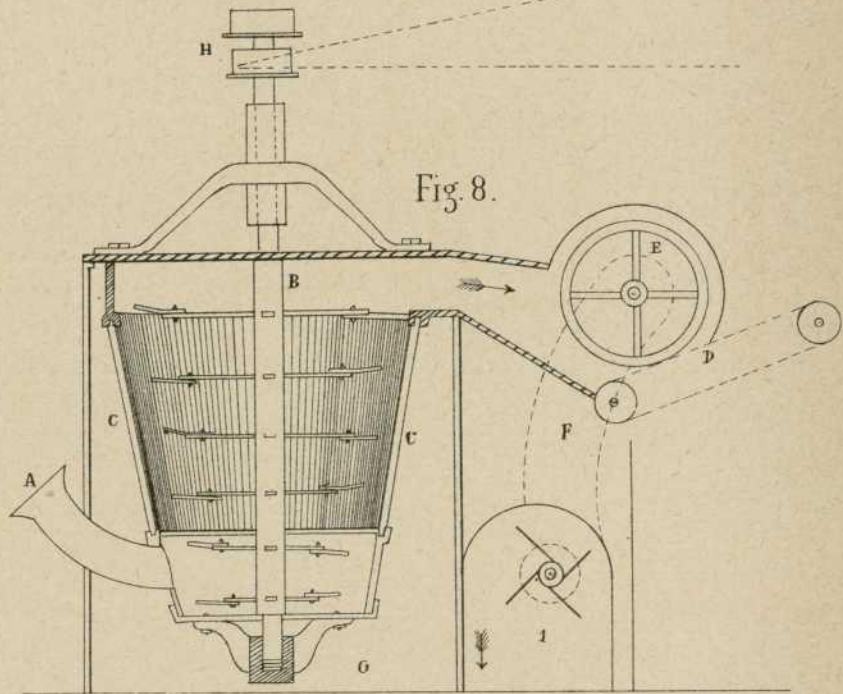
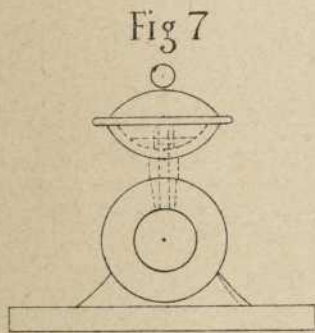
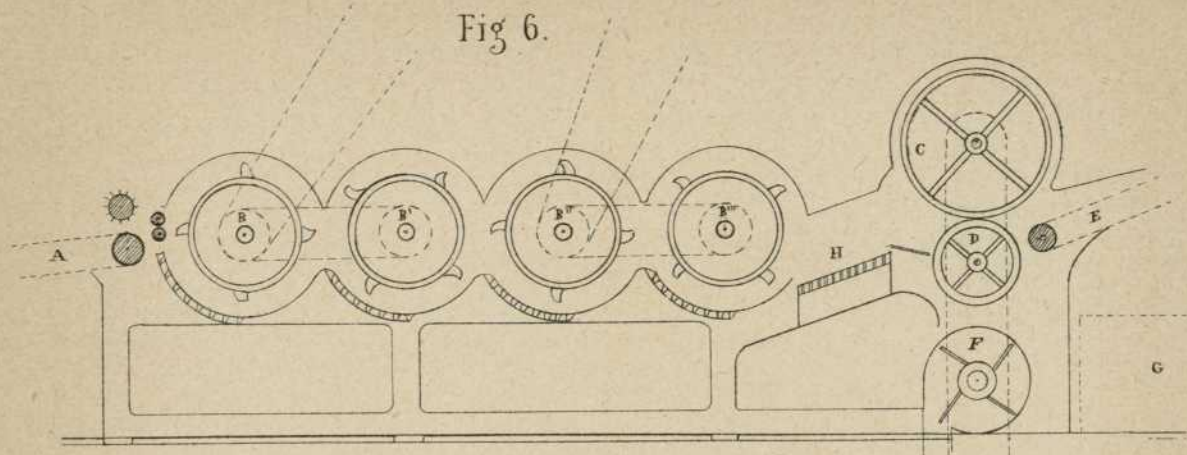


Fig. 13

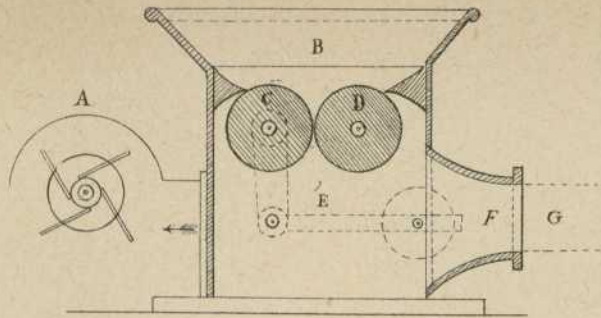


Fig. 12

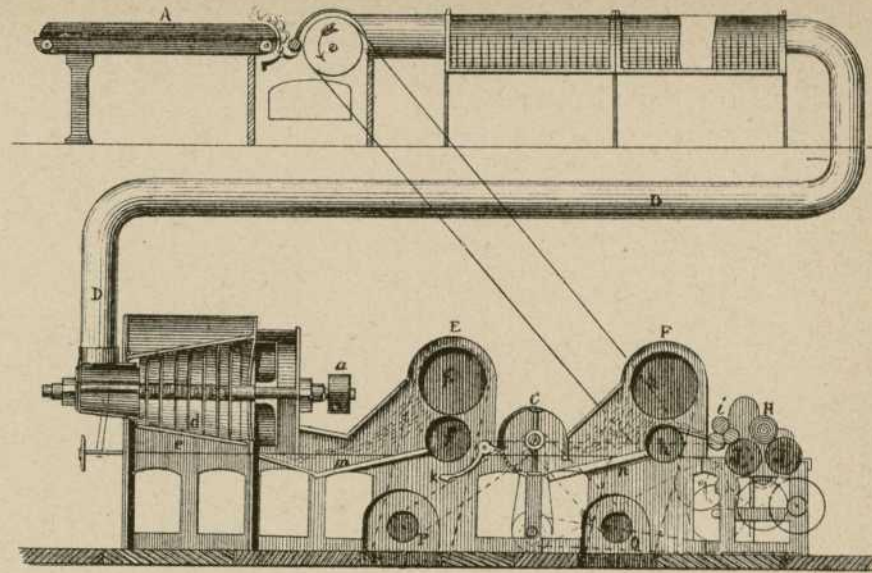


Fig. 10

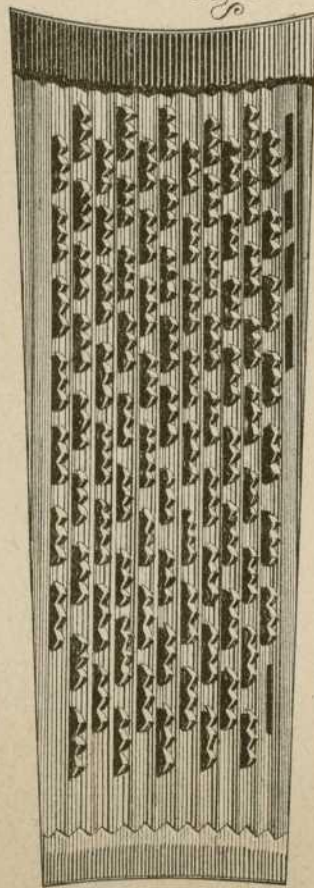


Fig. 11

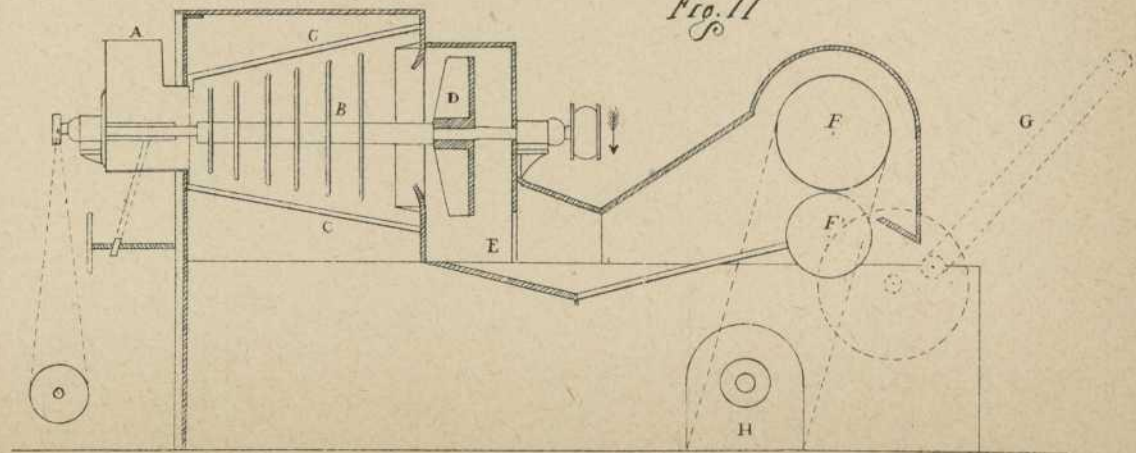


Fig. 14.

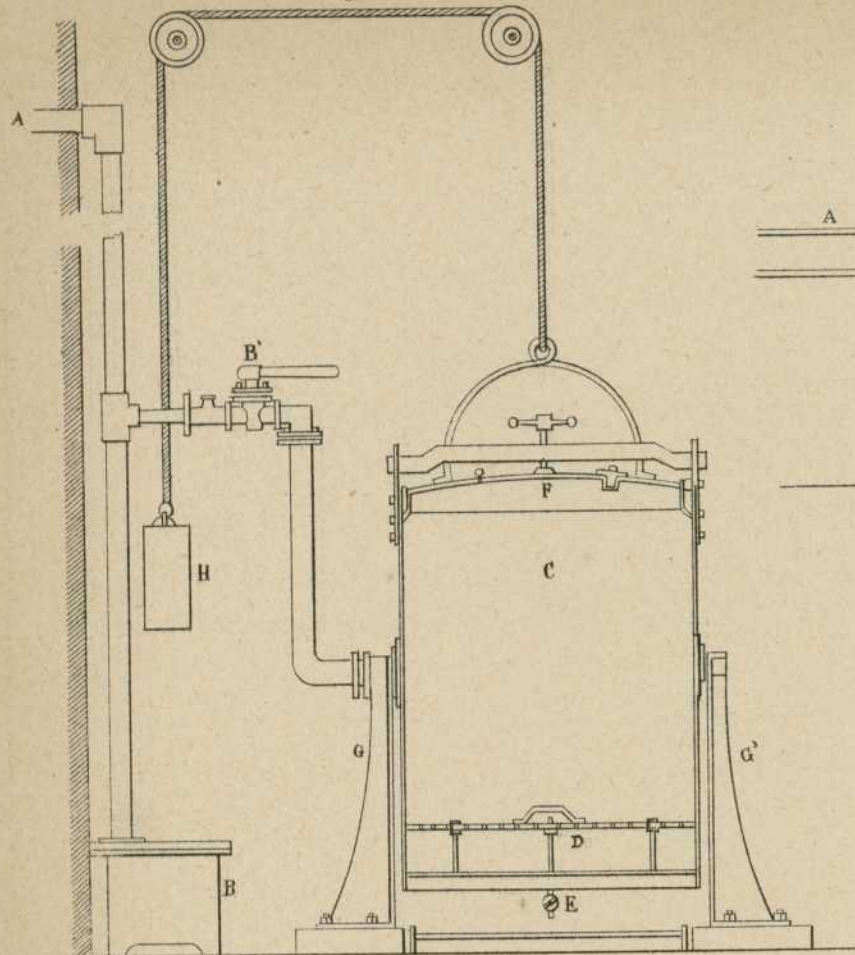


Fig. 15.

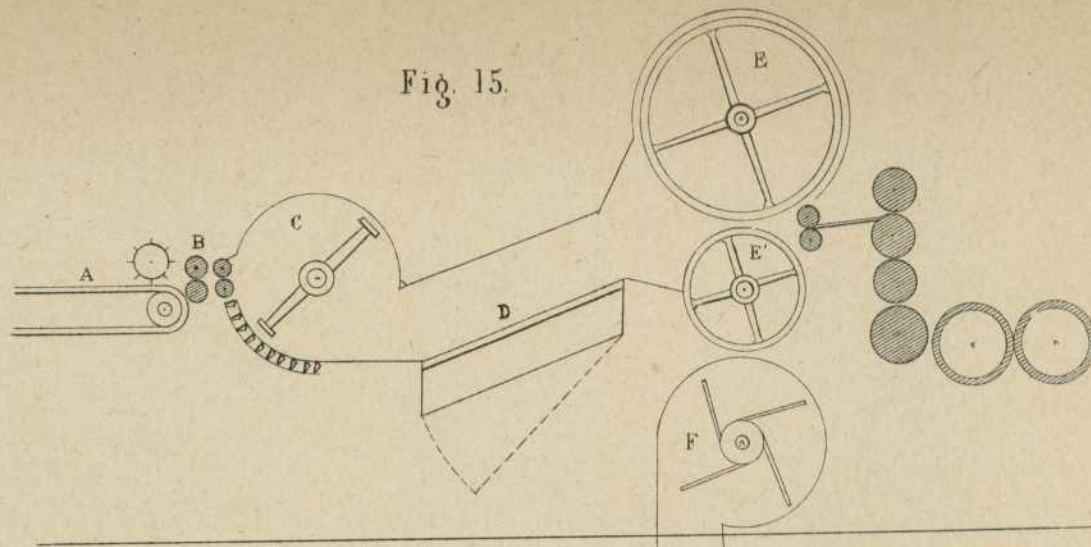


Fig. 17

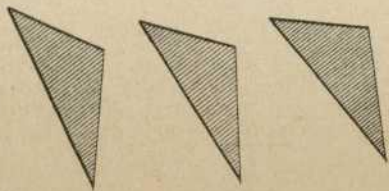


Fig. 16.

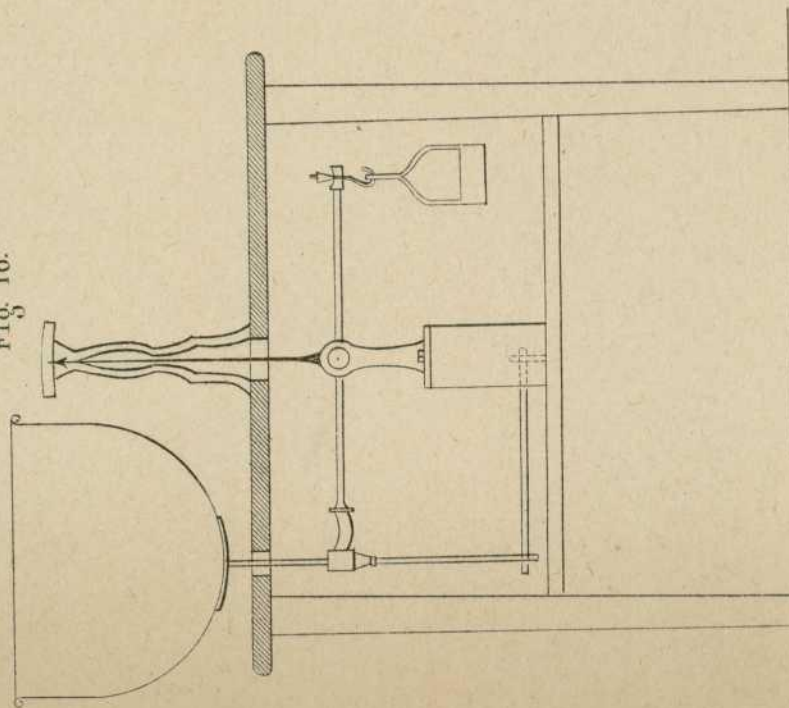


Fig. 18.

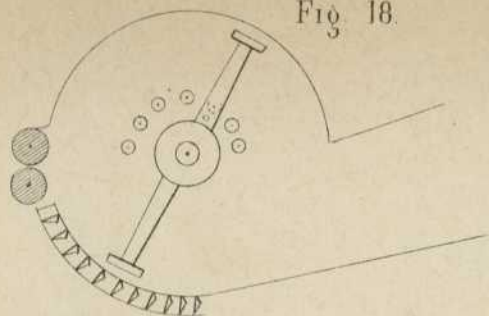


Fig. 19.

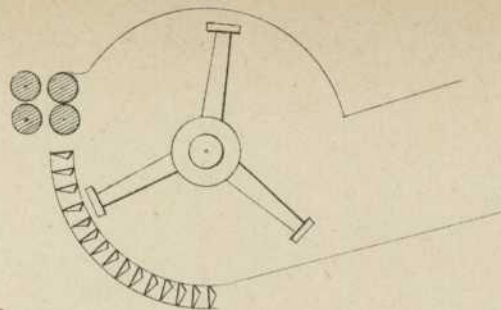


Fig. 20.

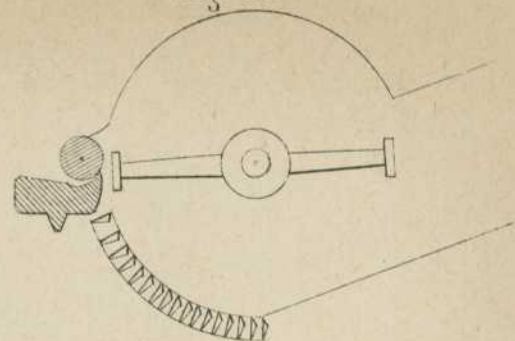


Fig. 22.



Fig. 21.

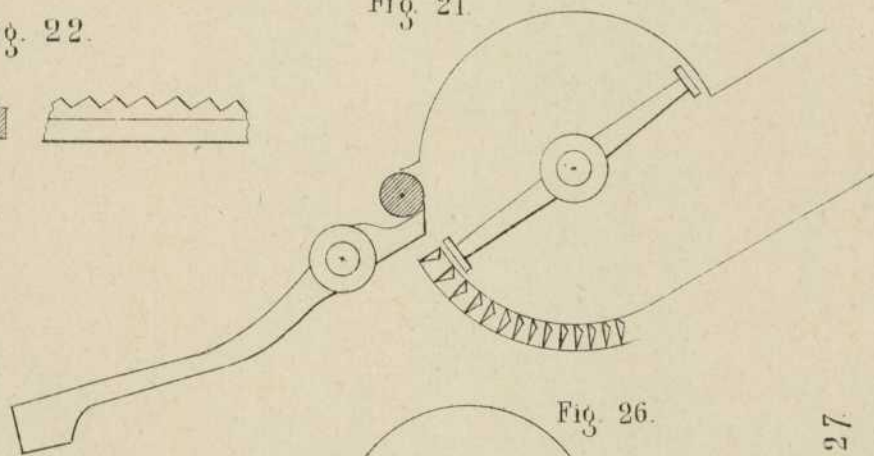


Fig. 23.



Fig. 25.

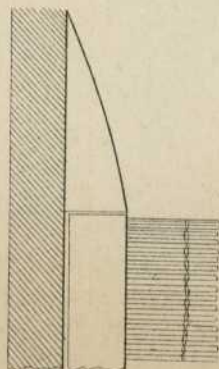


Fig. 24.

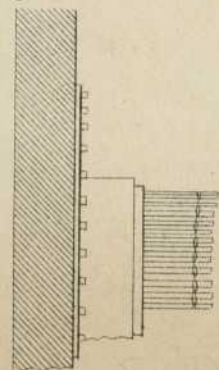


Fig. 26.

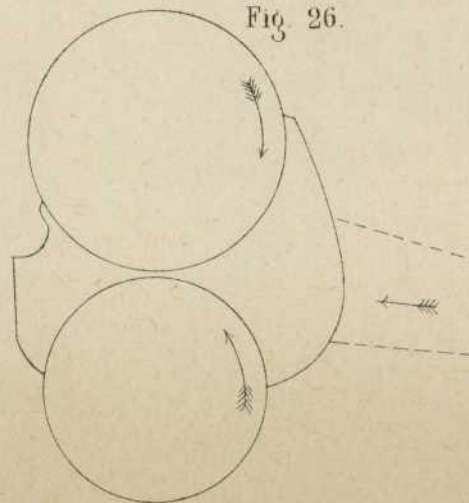


Fig. 27.

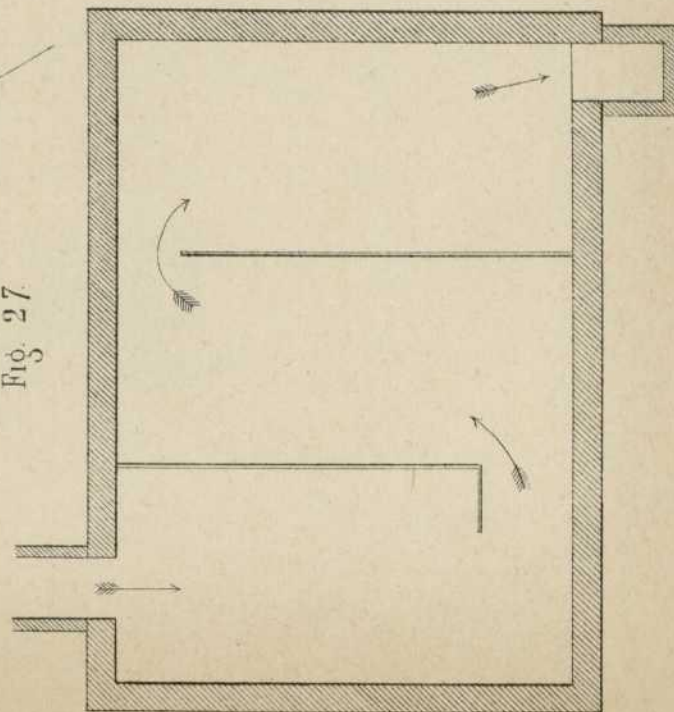


Fig. 28.

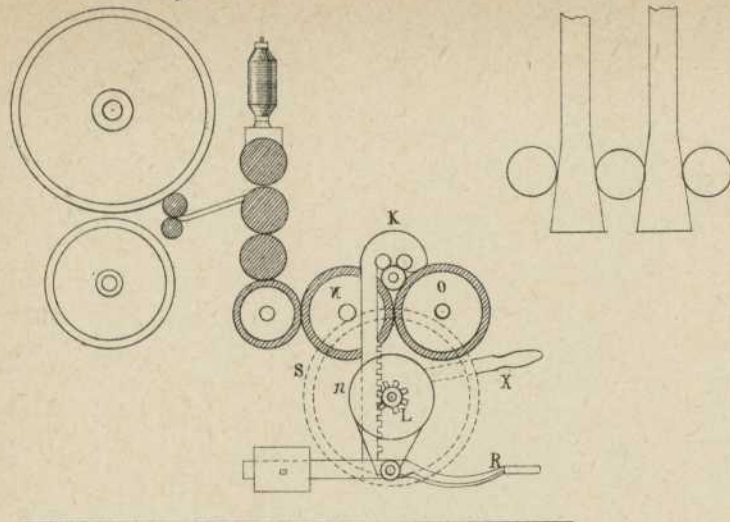


Fig. 30.

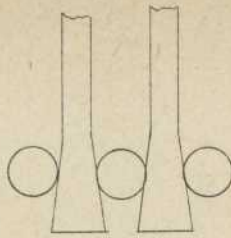


Fig. 29.

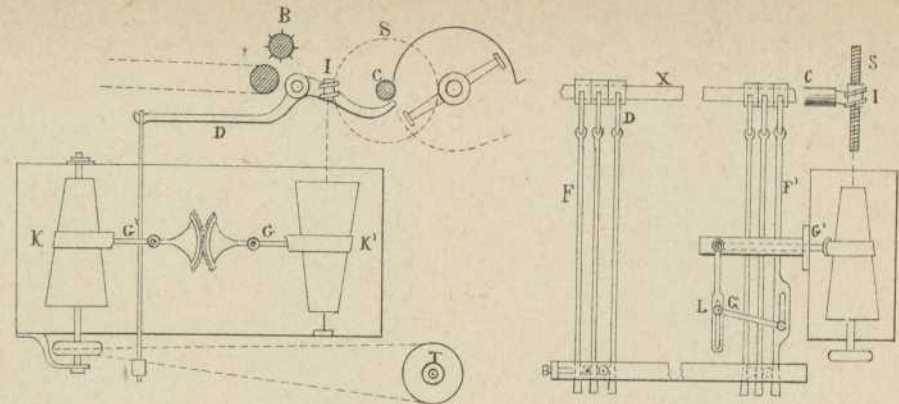


Fig. 32.

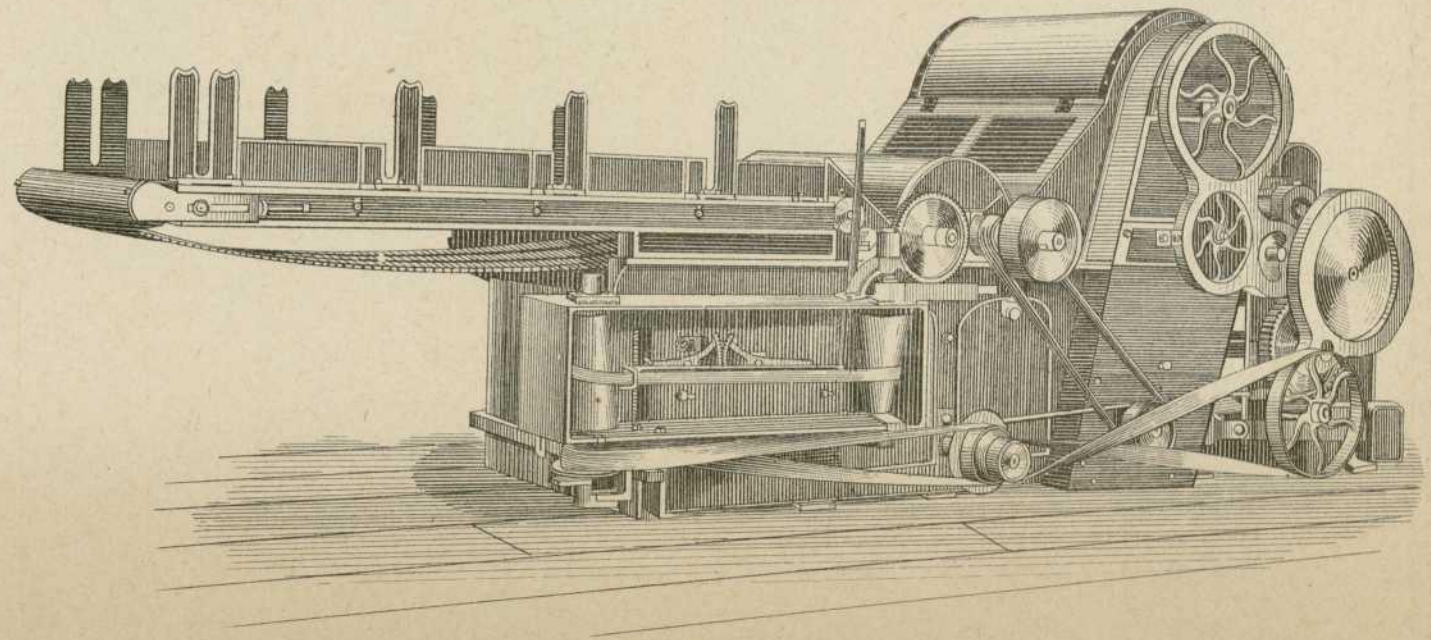


Fig. 31.

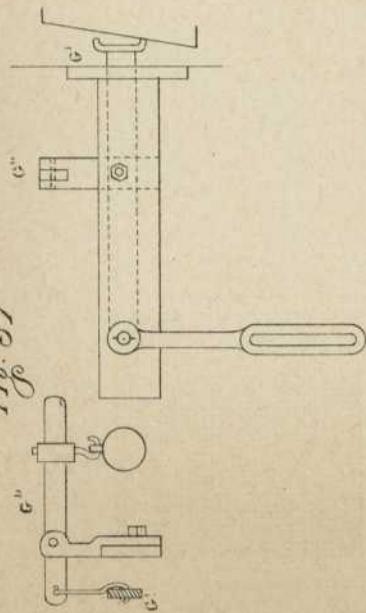


Fig. 33

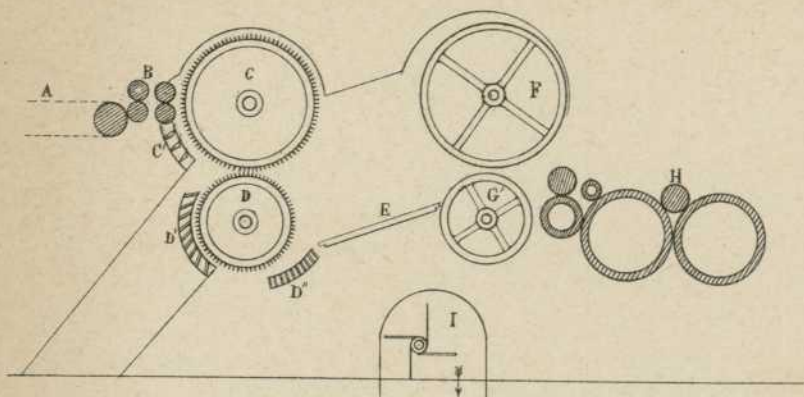


Fig. 37

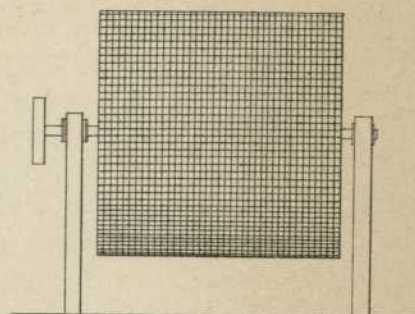


Fig. 34

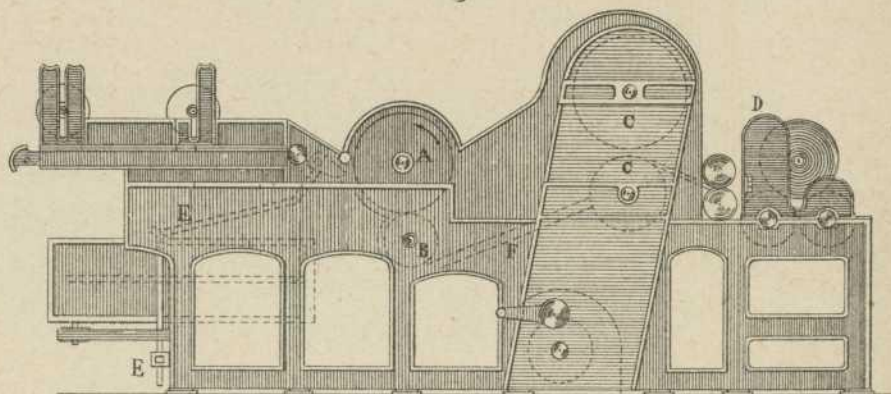


Fig. 35

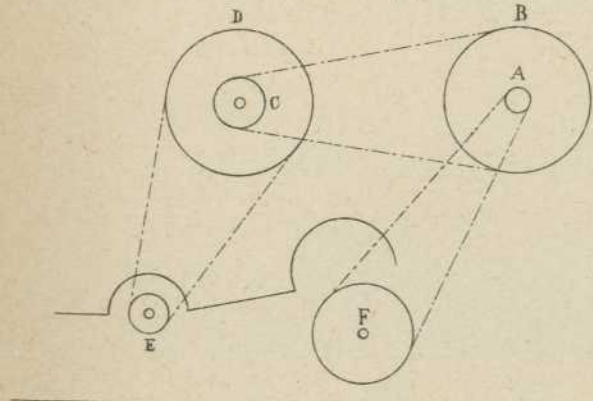
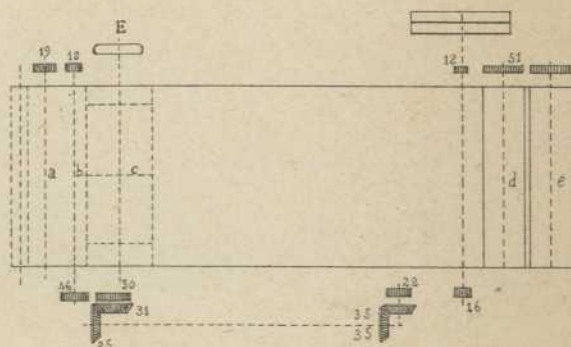


Fig. 36



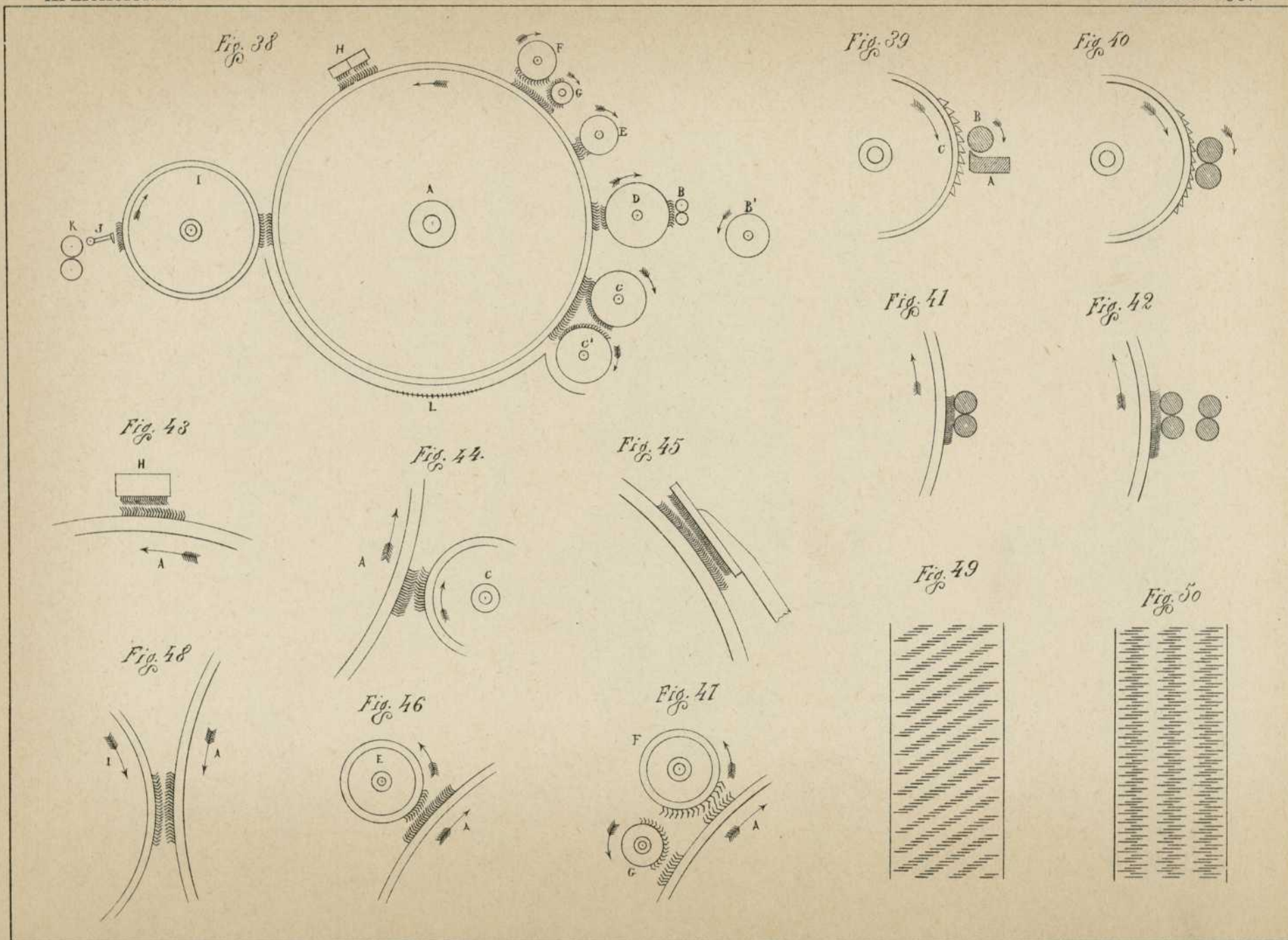


Fig. 51.



Fig. 52.

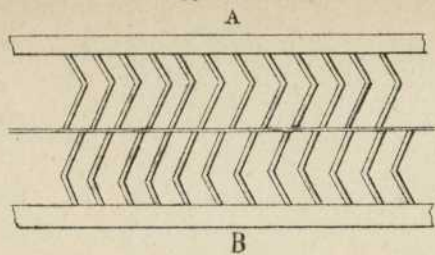


Fig. 63.

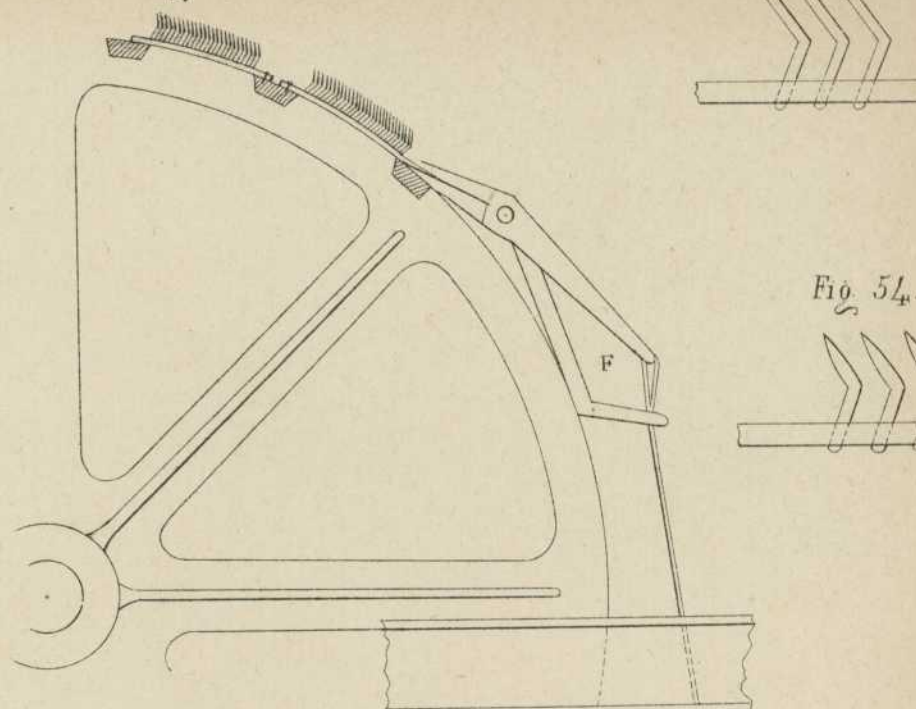


Fig. 53.

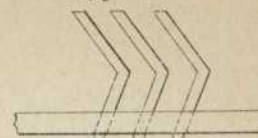


Fig. 56.

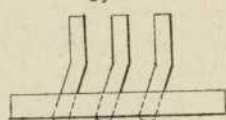


Fig. 54.

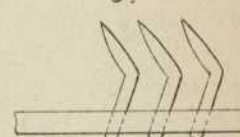


Fig. 57.

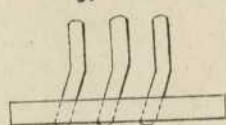


Fig. 59.

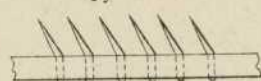


Fig. 55.

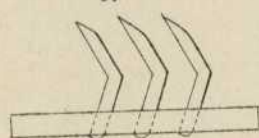


Fig. 60.

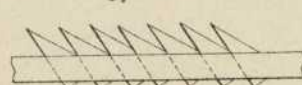


Fig. 58.

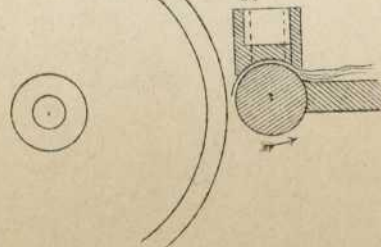


Fig. 61.



Fig. 62.

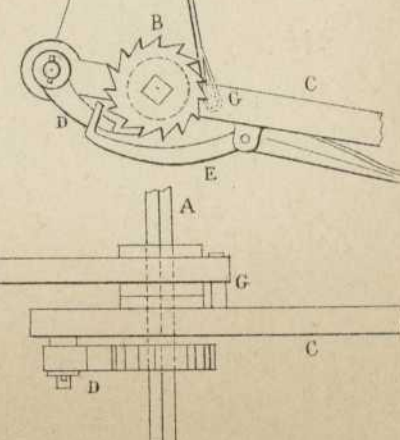
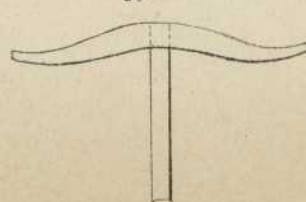


Fig. 64.

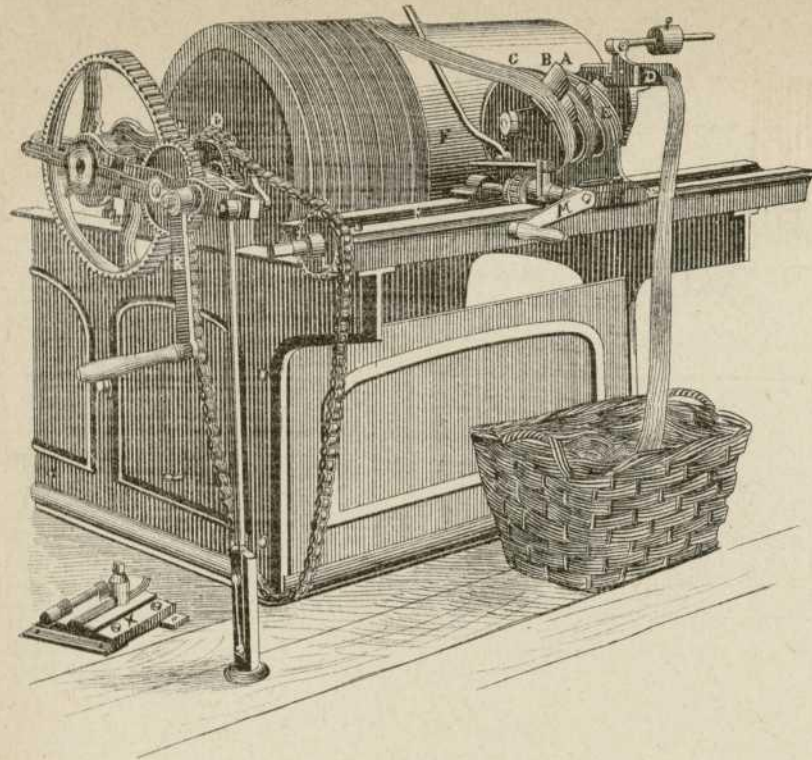


Fig. 65.

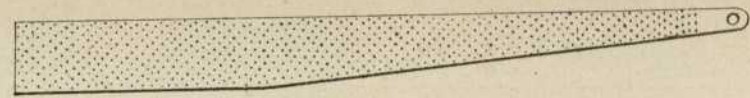


Fig. 69.

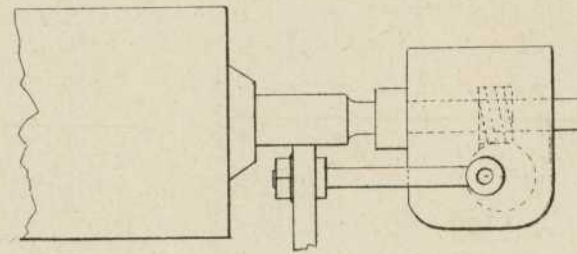


Fig. 68.

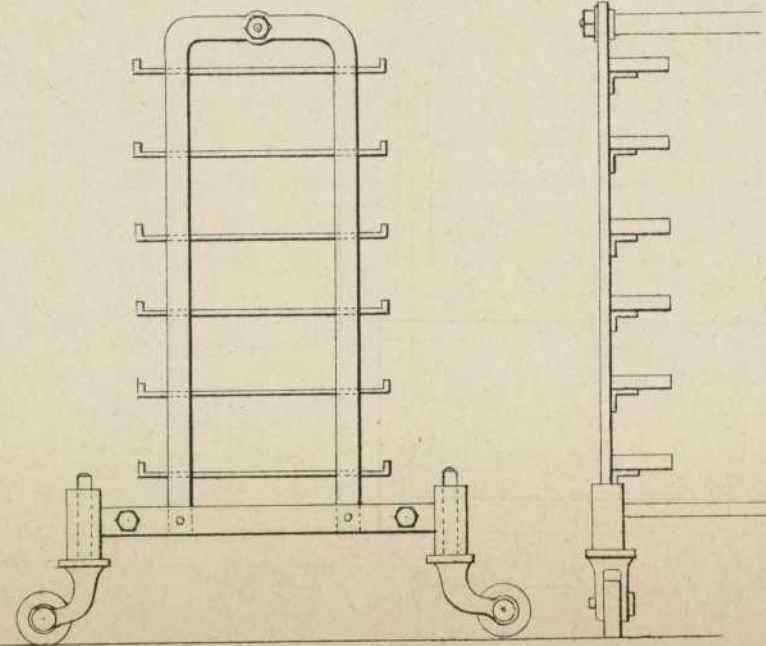


Fig. 67.

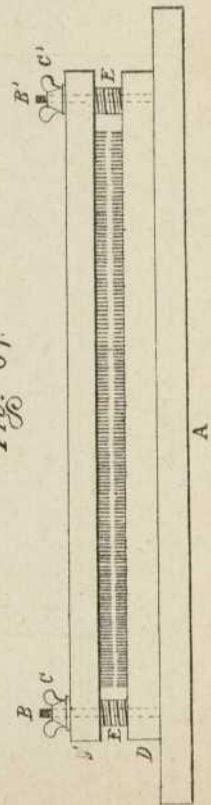


Fig. 66.

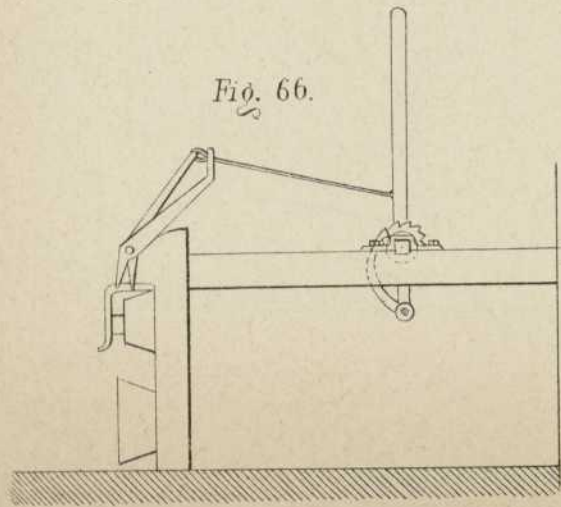


Fig. 70.

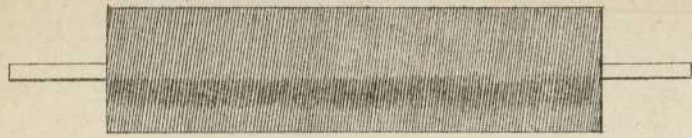


Fig. 76.

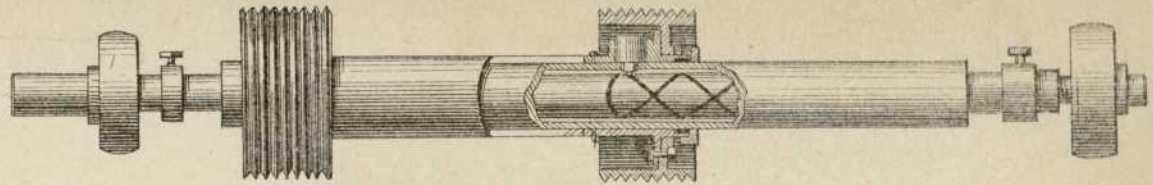


Fig. 72.

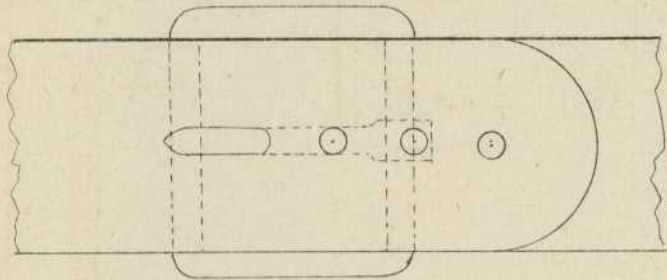


Fig. 73.

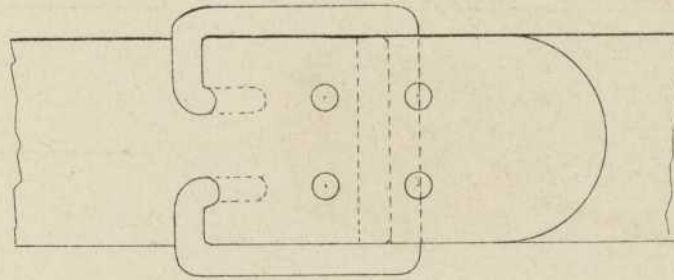


Fig. 75.

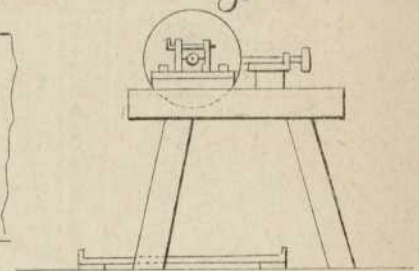


Fig. 74.

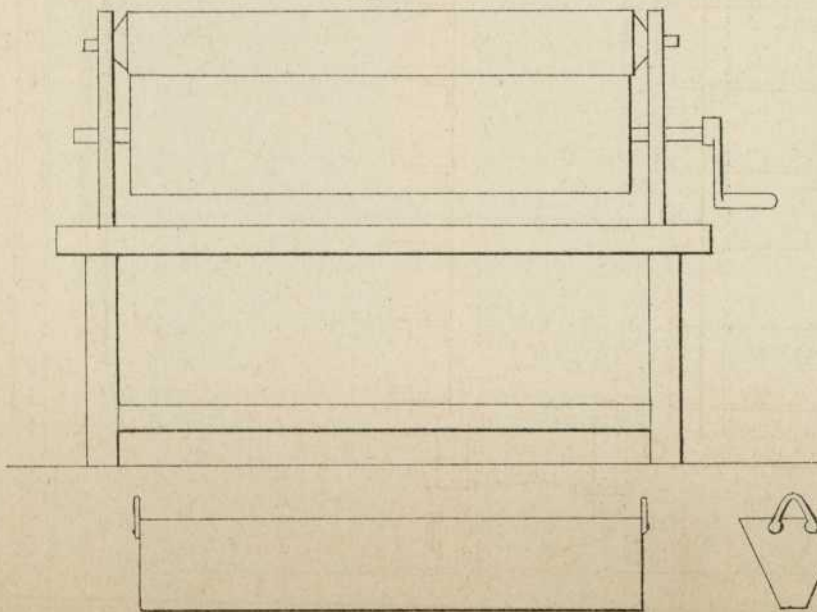
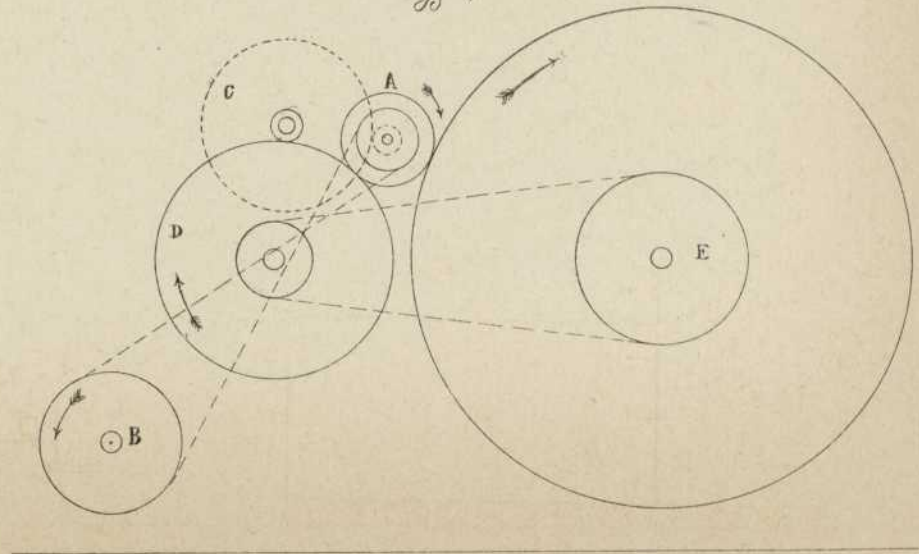


Fig. 71.



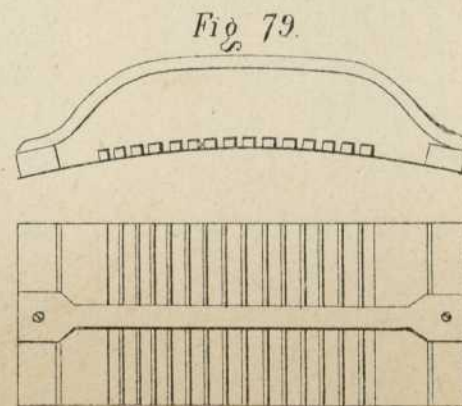
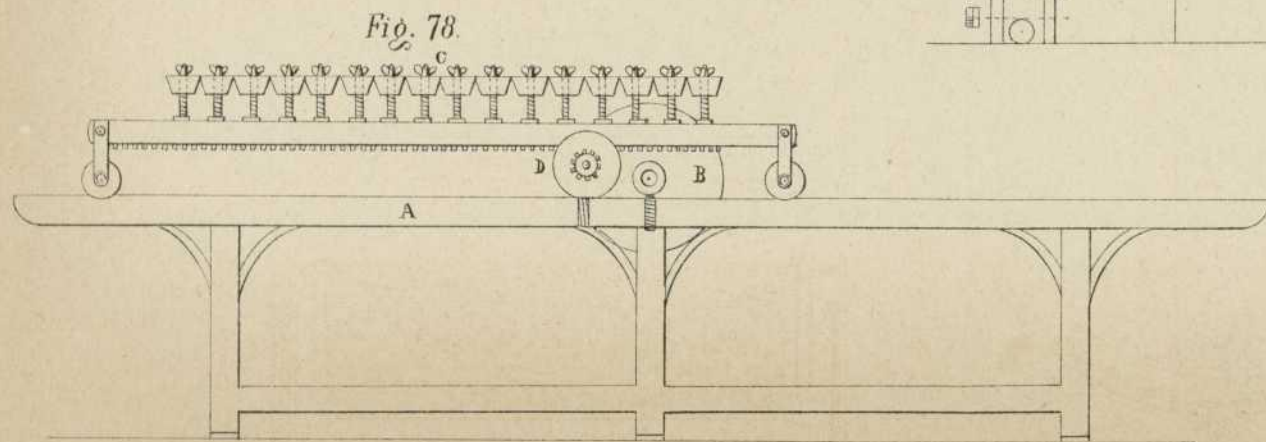
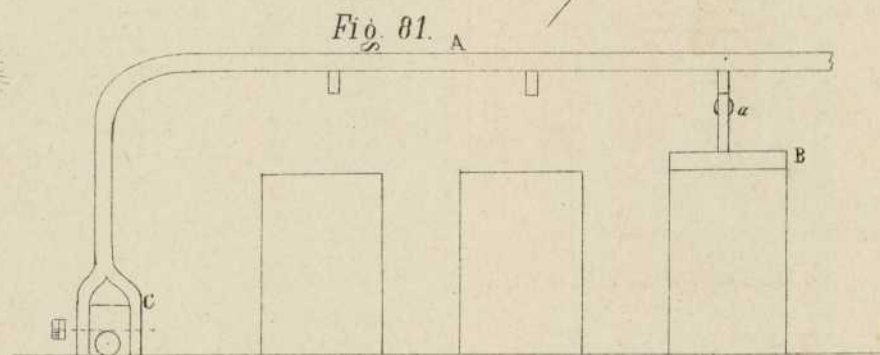
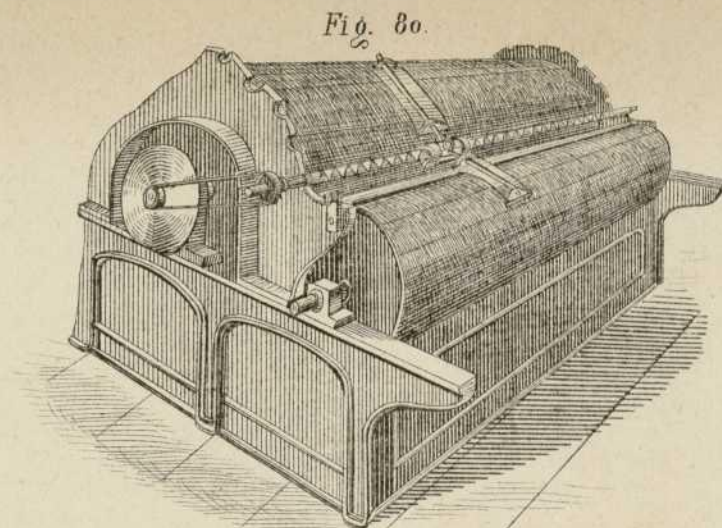
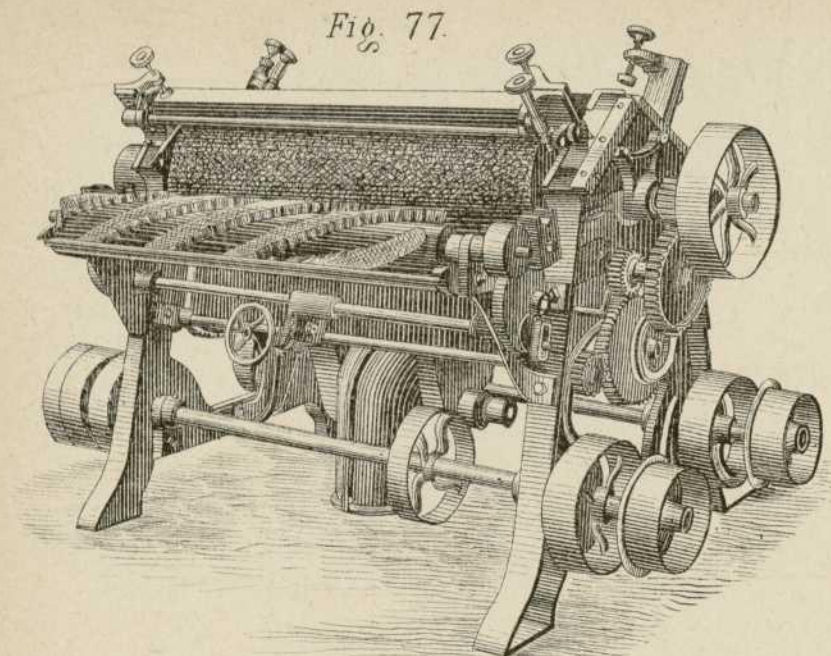


Fig. 82.

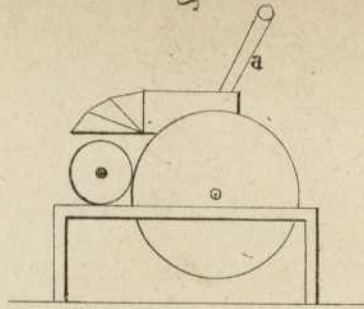


Fig. 83.

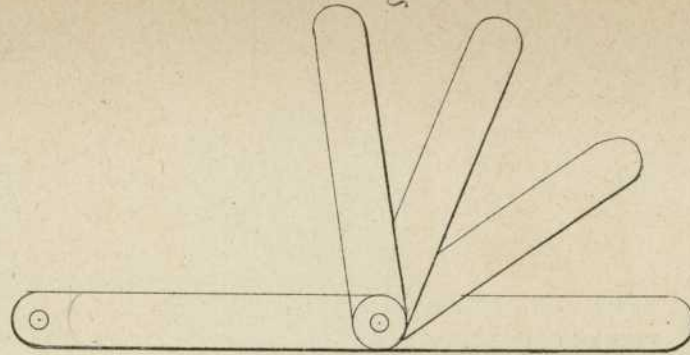


Fig. 84.

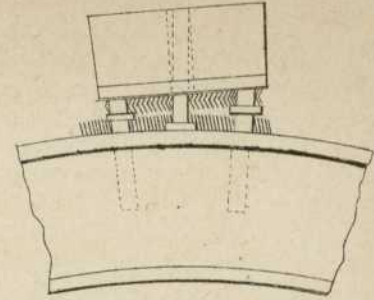


Fig. 86.

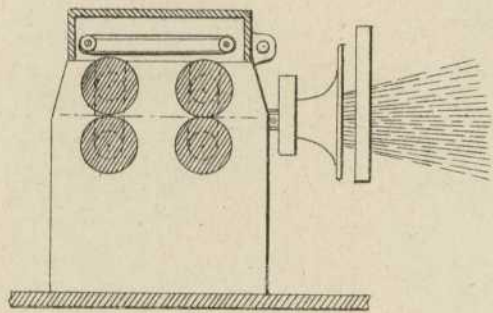


Fig. 87.

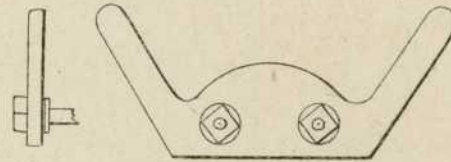


Fig. 85.

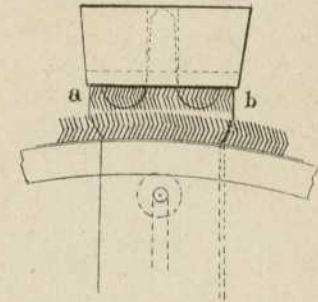
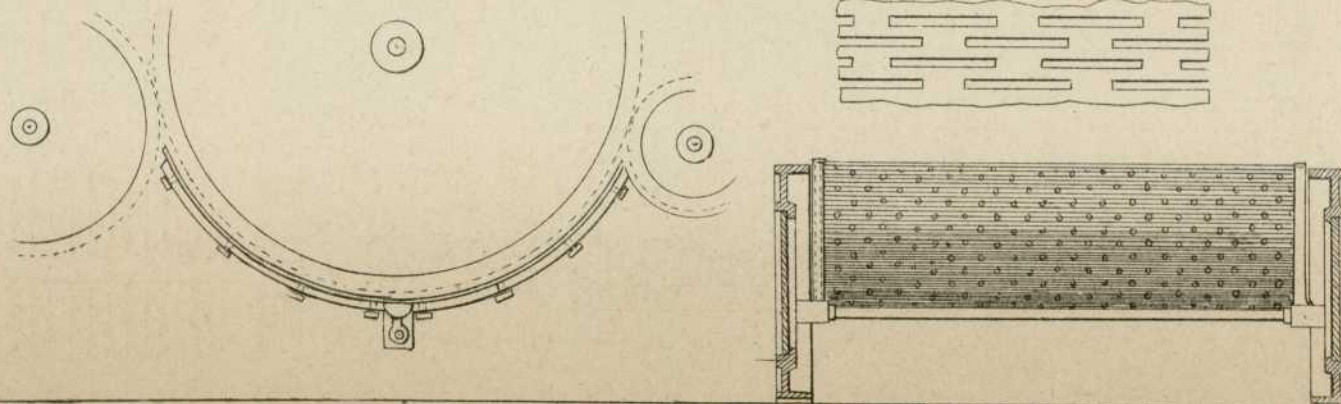
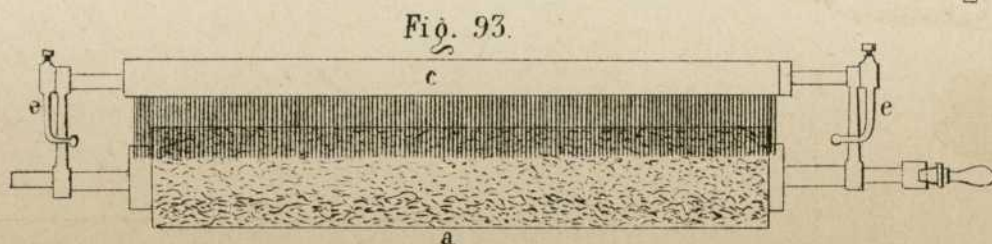
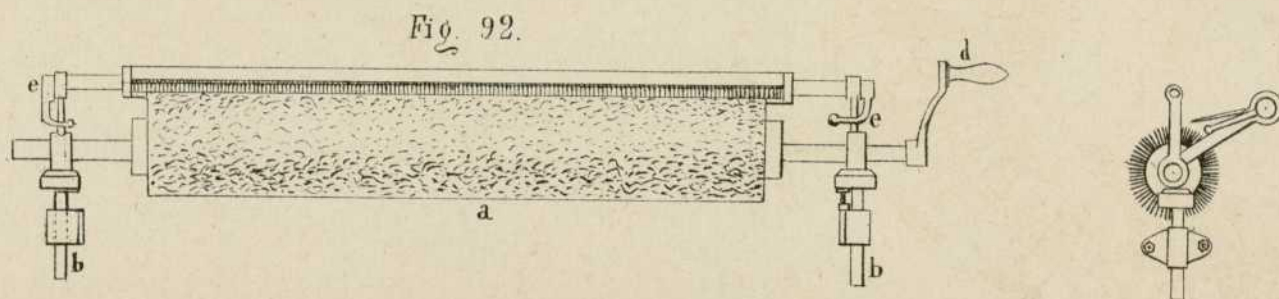
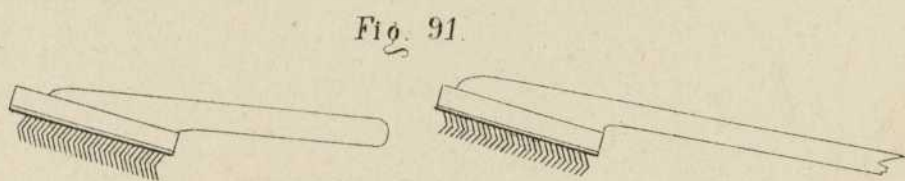
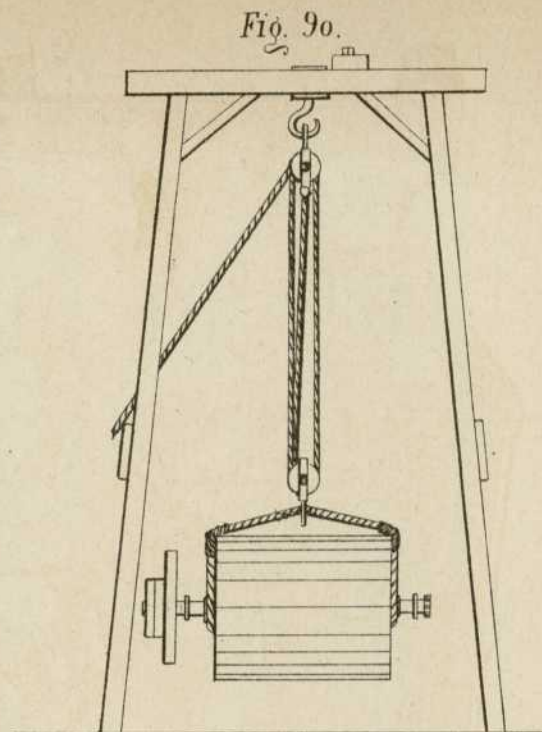
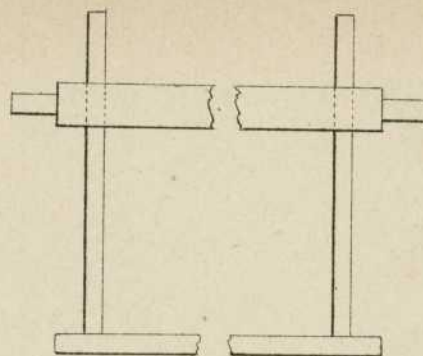
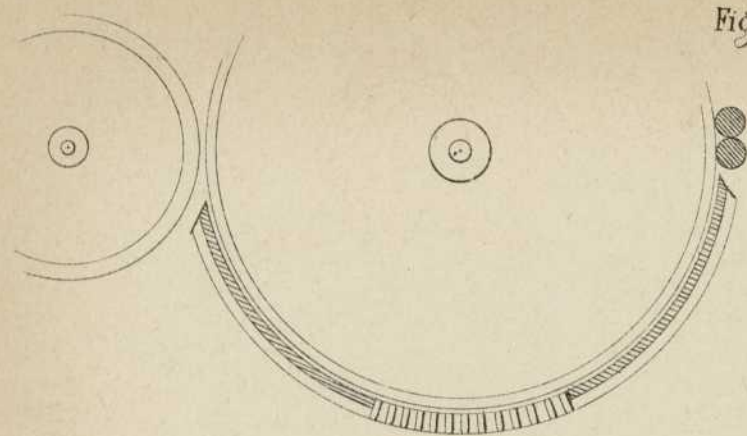
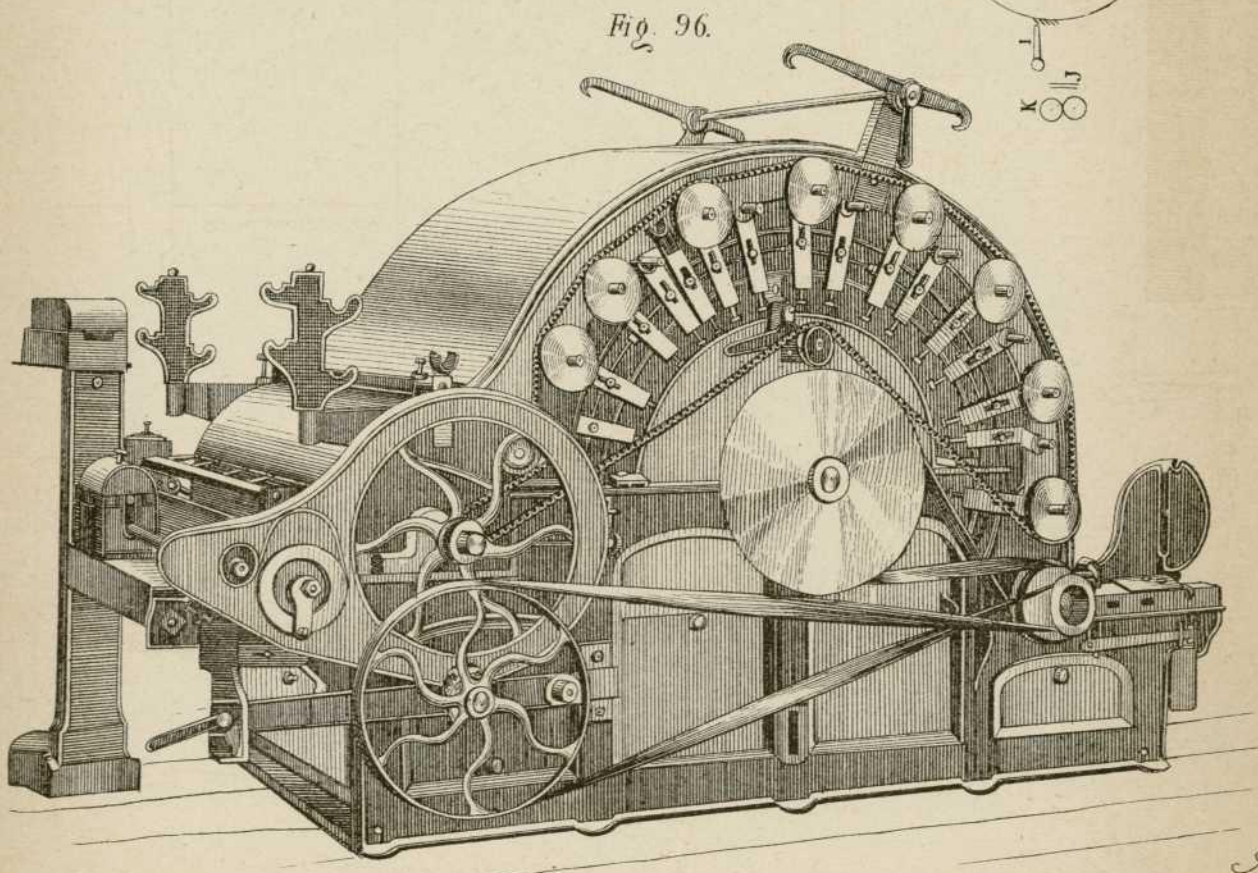
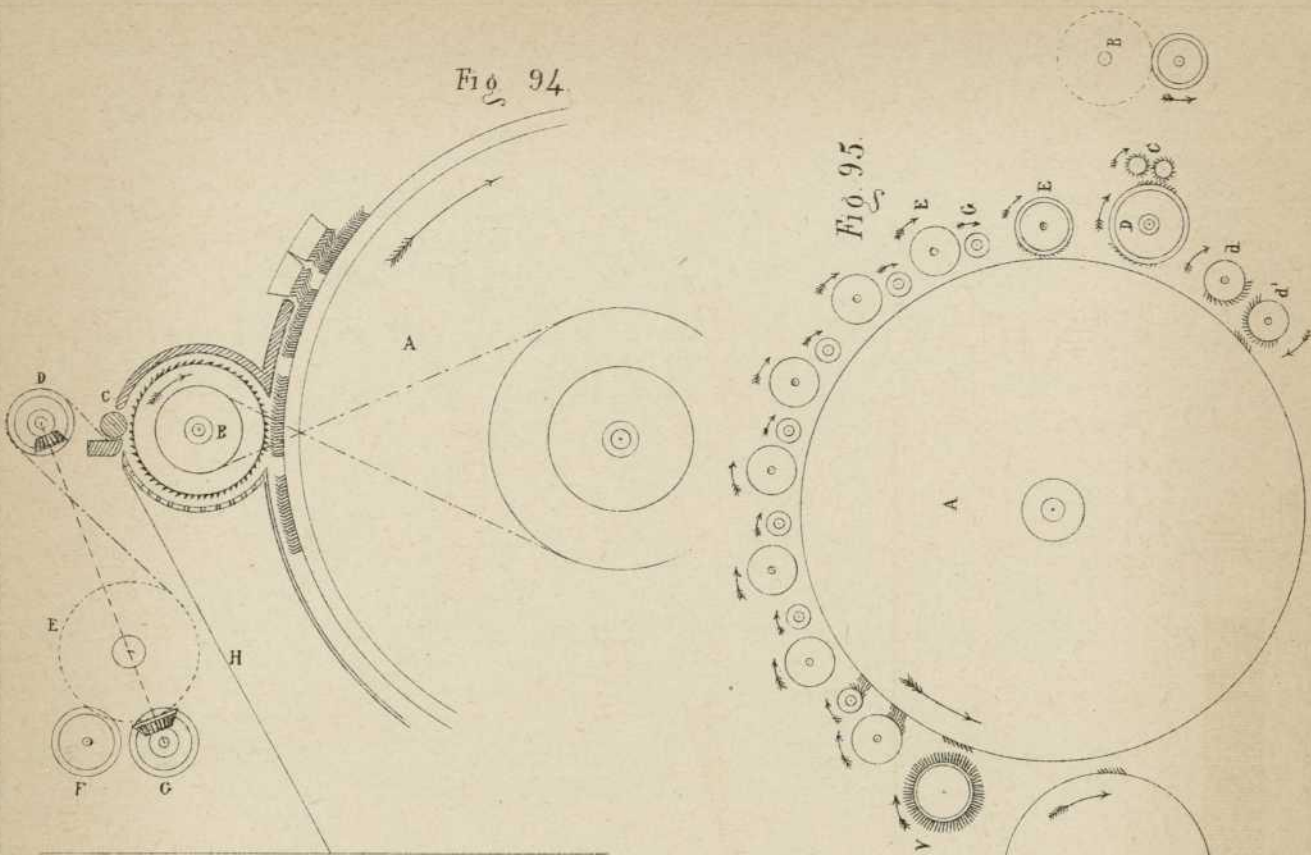


Fig. 88.







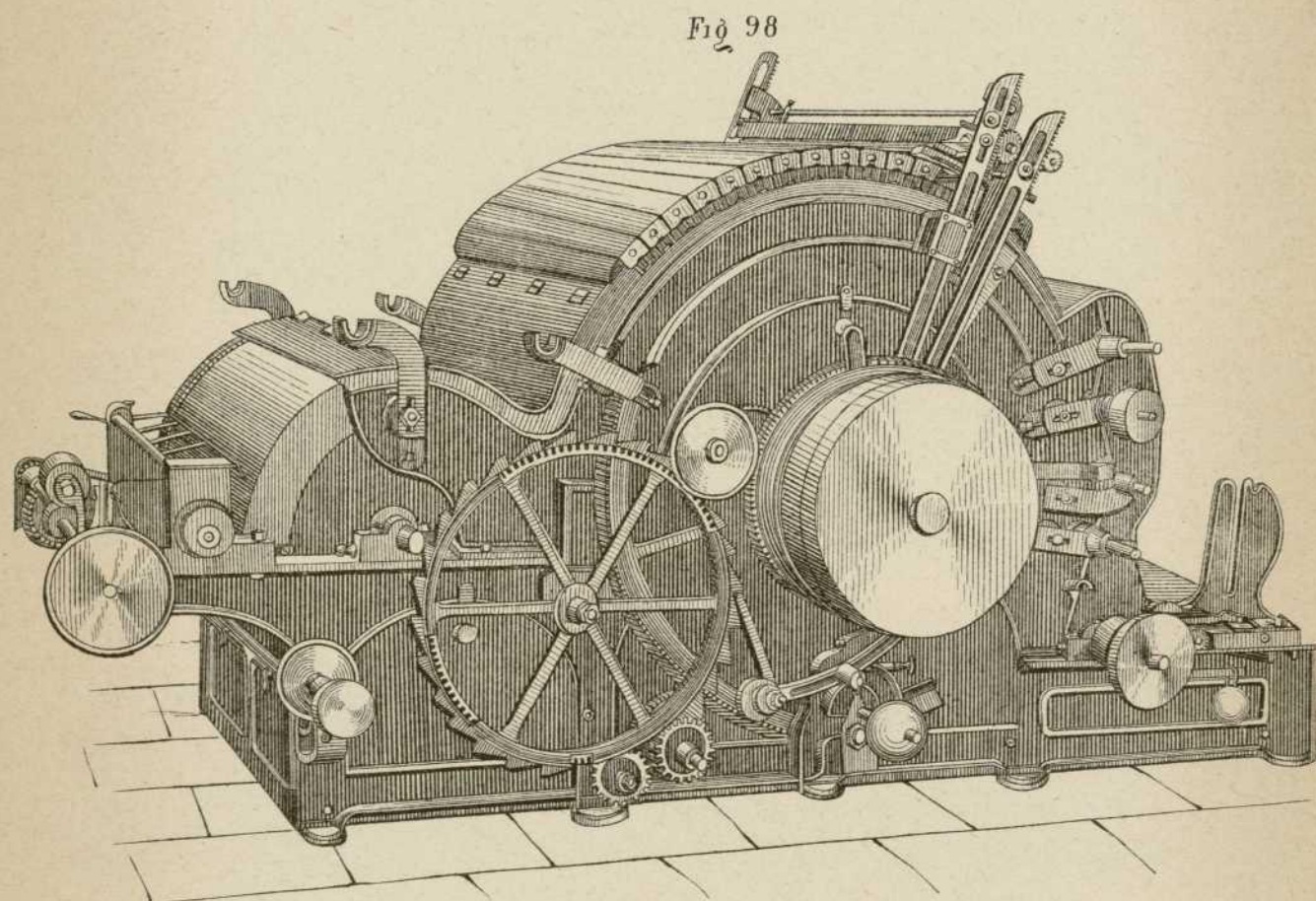
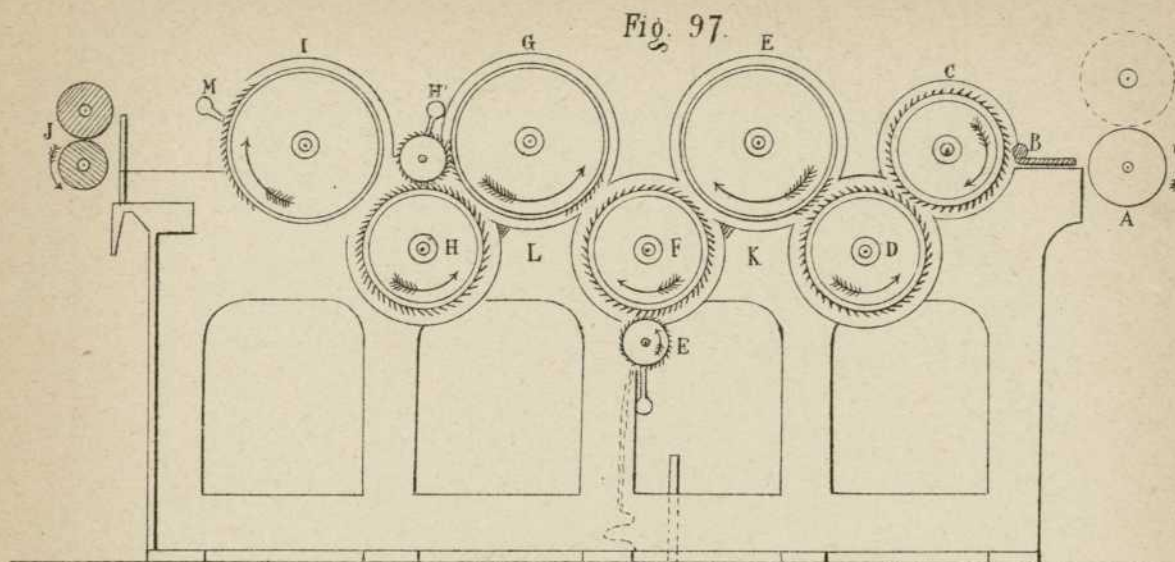


Fig. 99

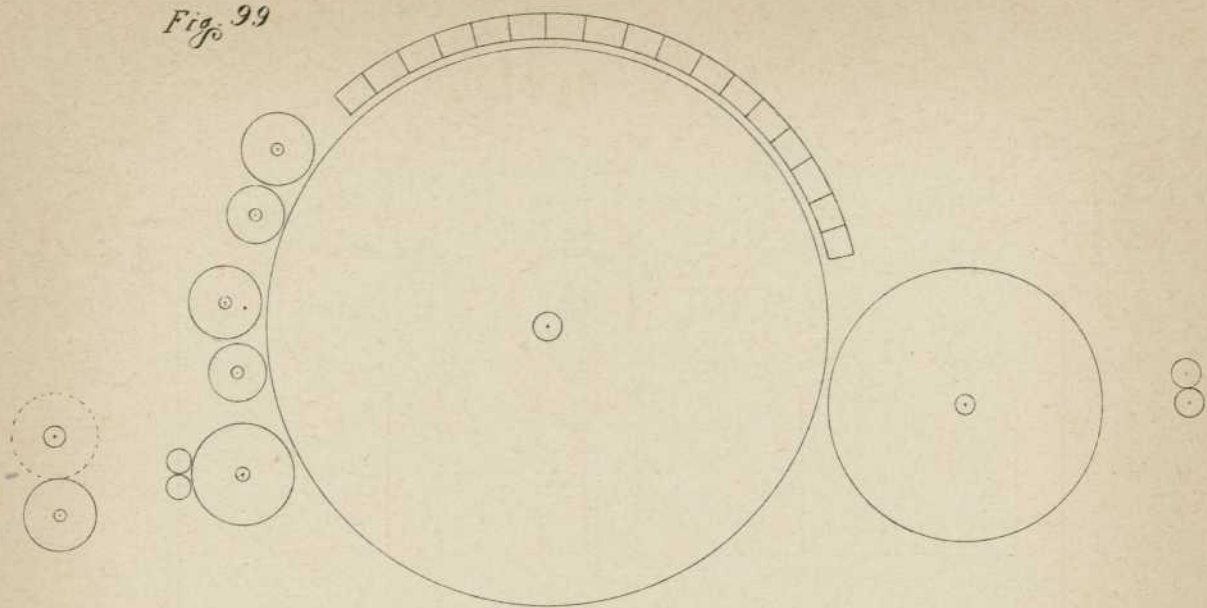


Fig. 100

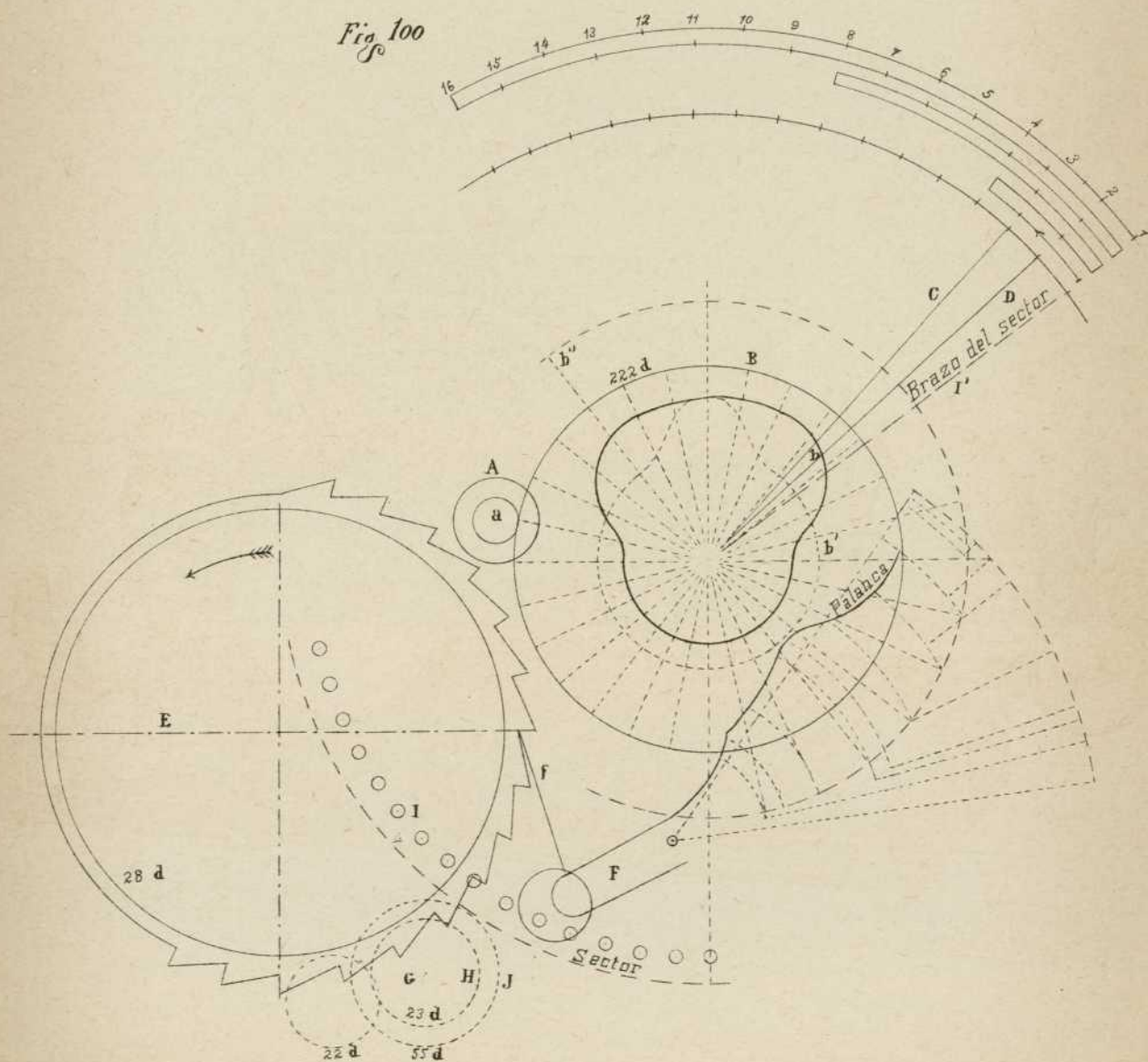


Fig. 102

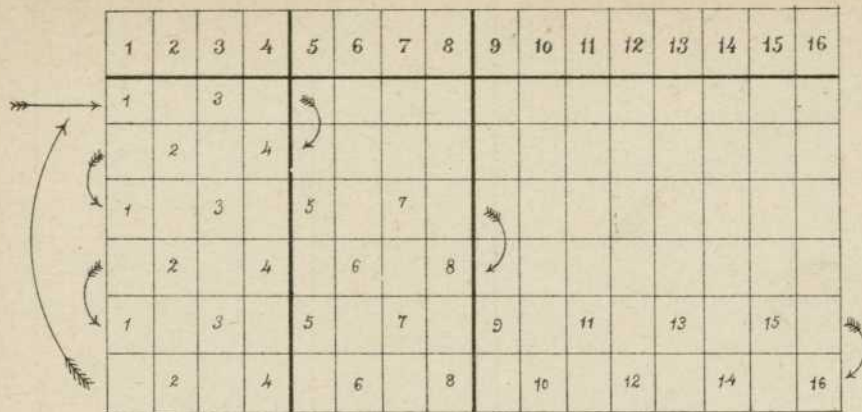


Fig. 103

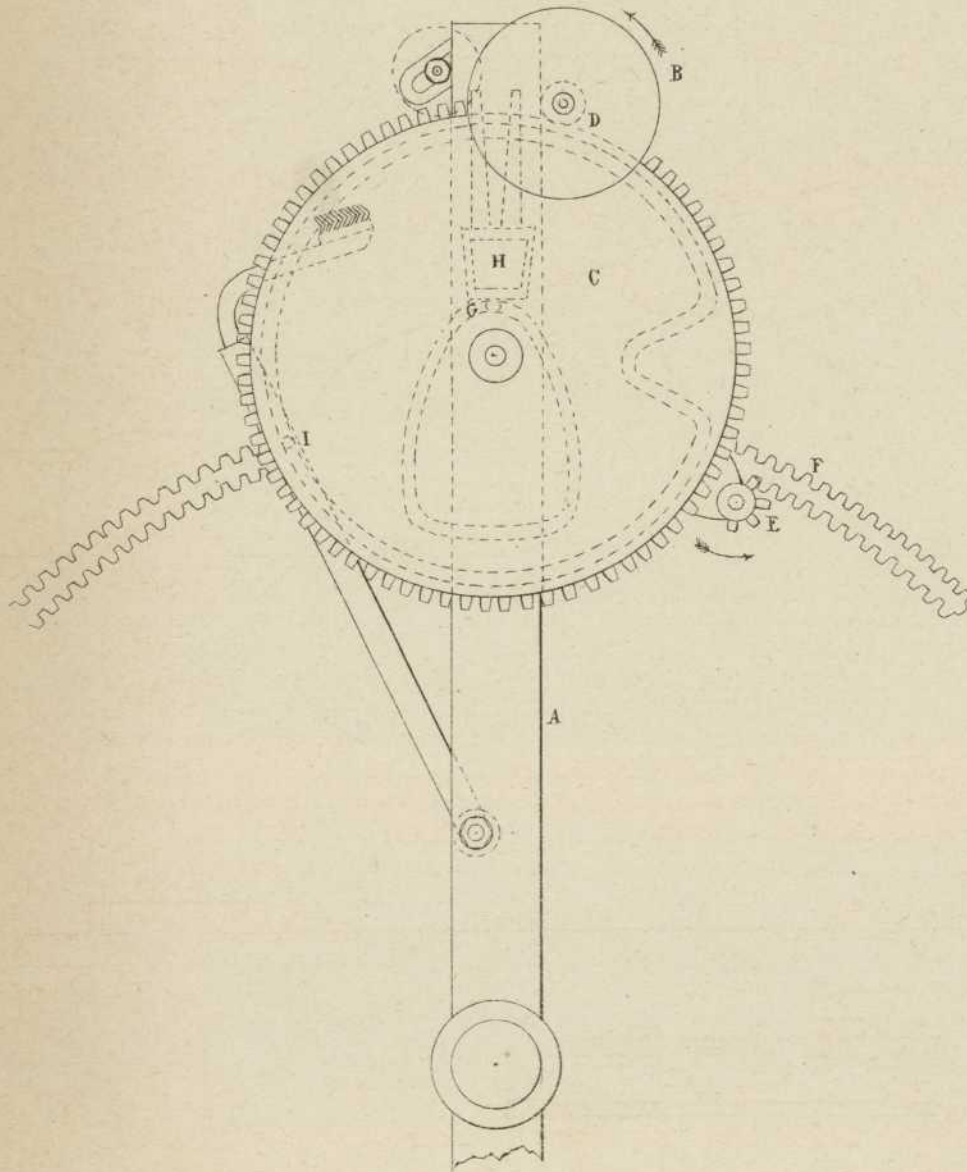
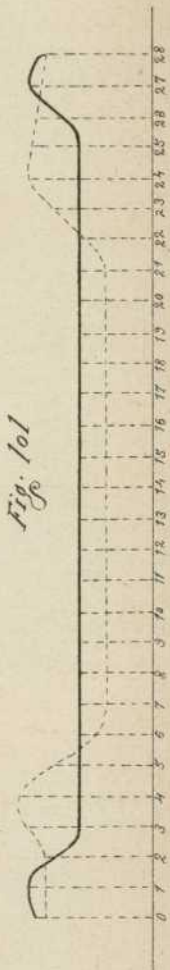


Fig. 101



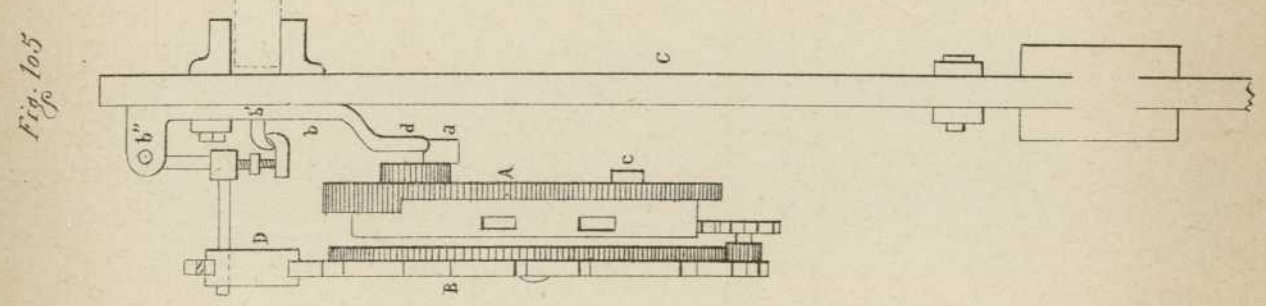
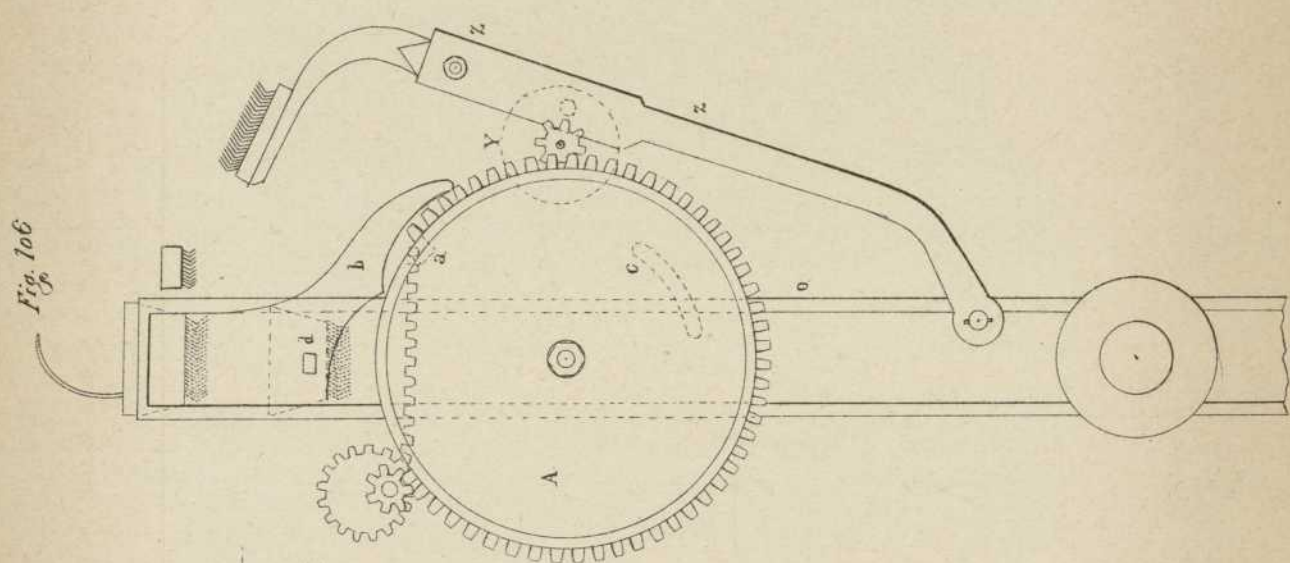
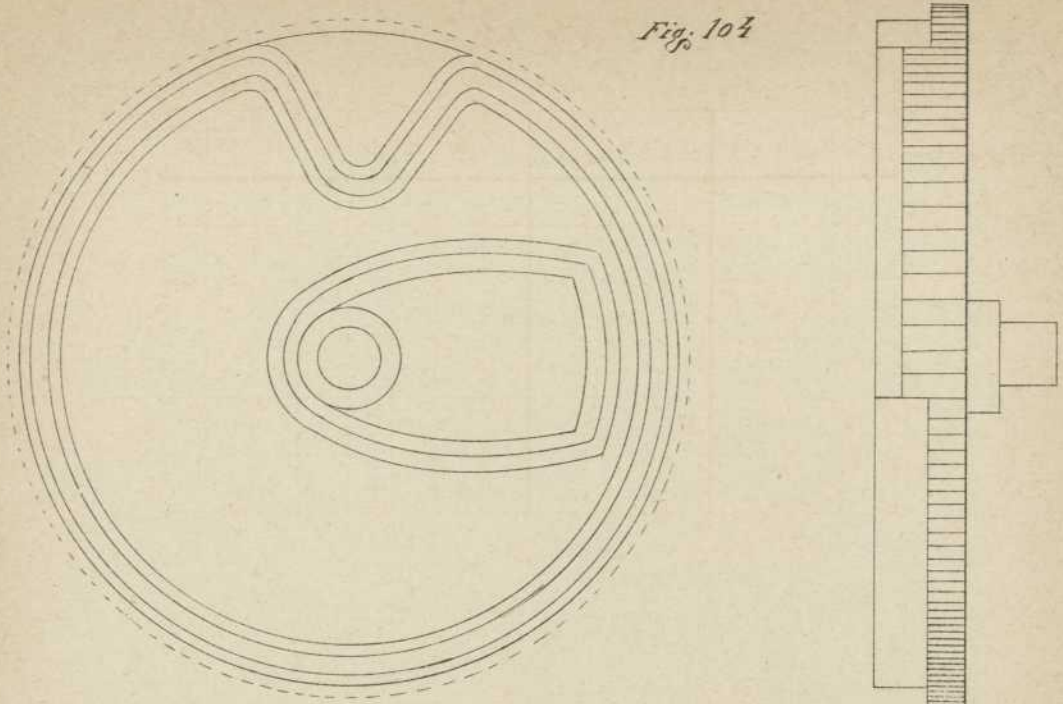


Fig. 107

	1	2	3	4	5	6	7	8	9	10	11	12	13	14	15	16
1																
2	1		3		5		0		9		11		0		15	
3		2		4		6		0		10		12		0		0
4			3		5		7		0		0		13		0	
5		2		4		6		8		0		0		14		0
6			3		5		7		9		11		0		0	
7		2		4		6		8		10		0		0		16

Fig. 108

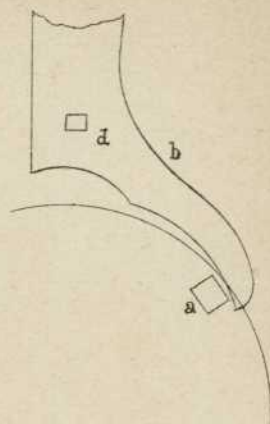
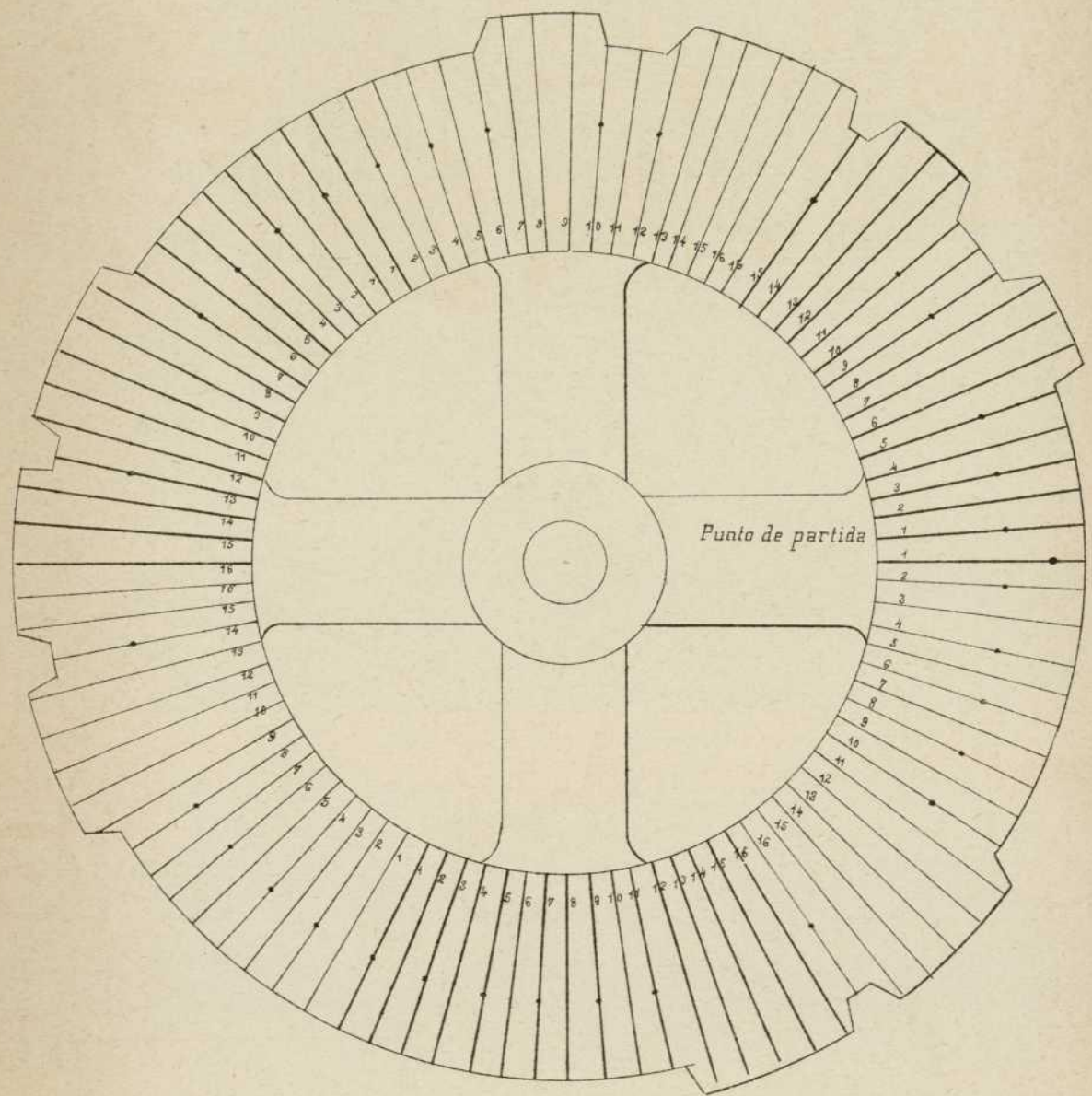


Fig. 109



A

Fig. 110

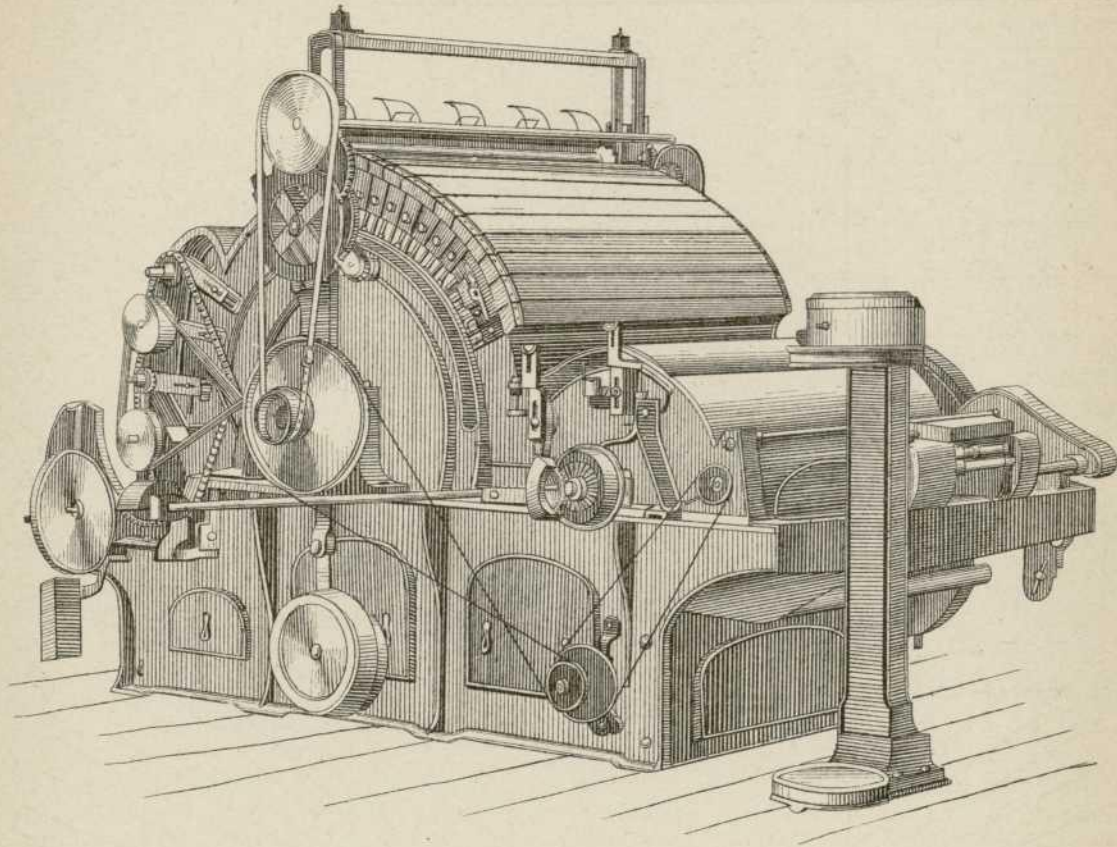


Fig. 111

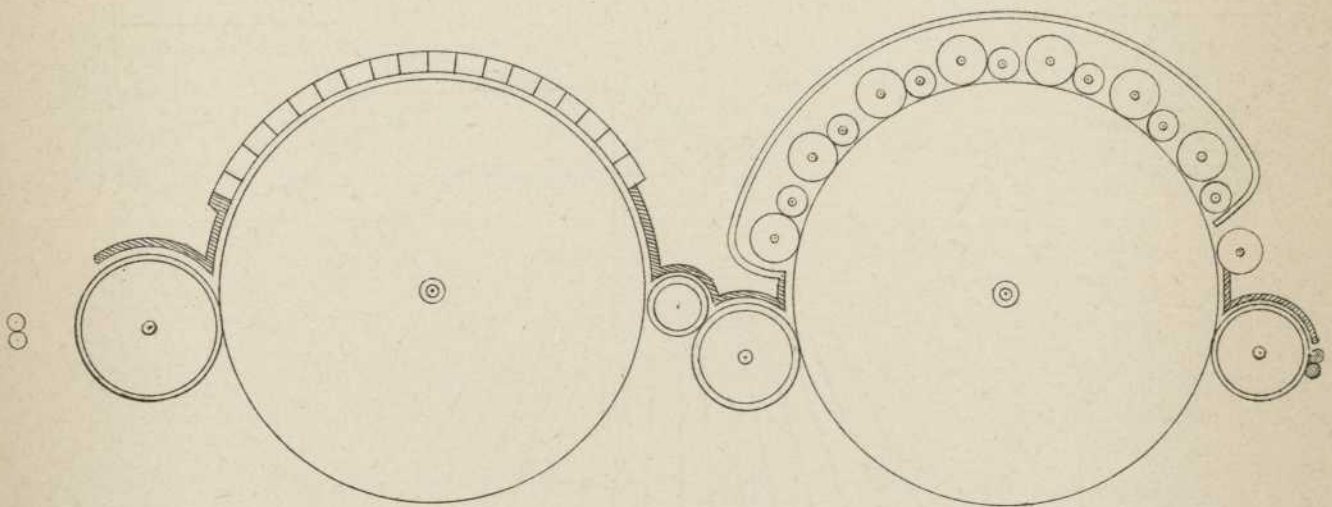


Fig. 112

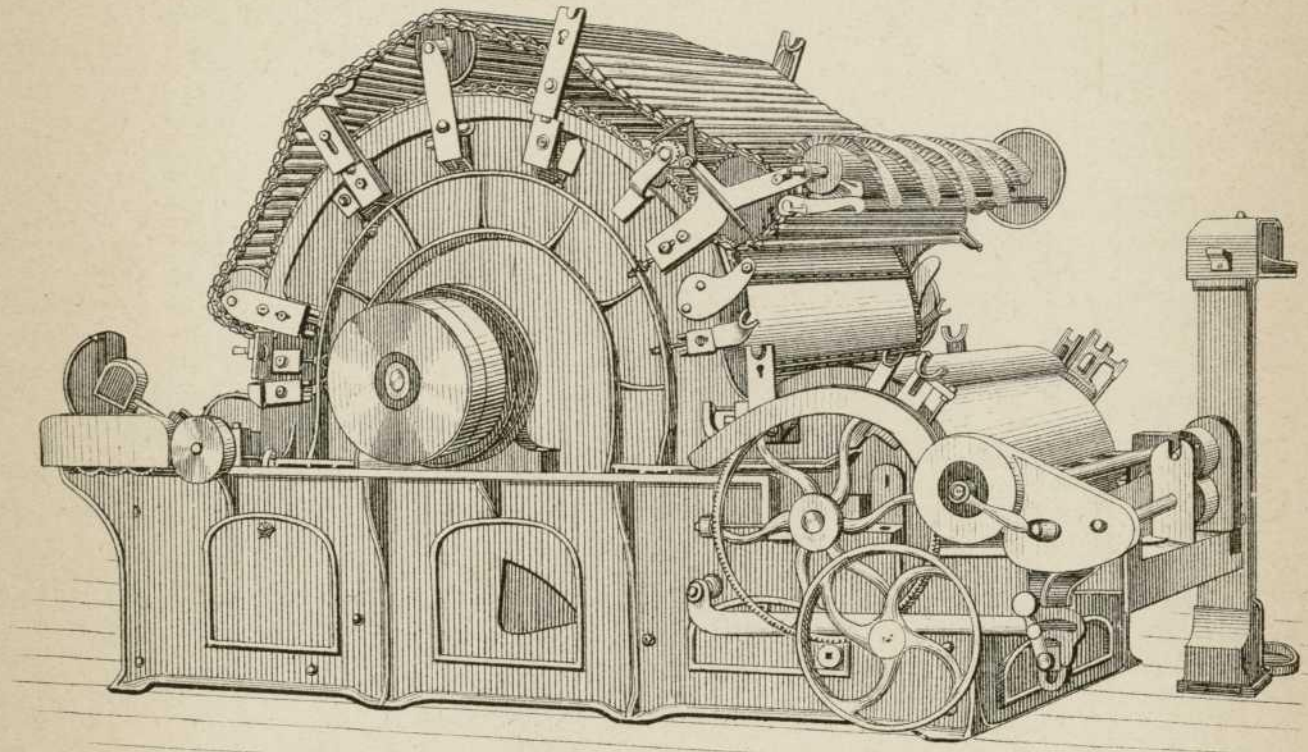


Fig. 113

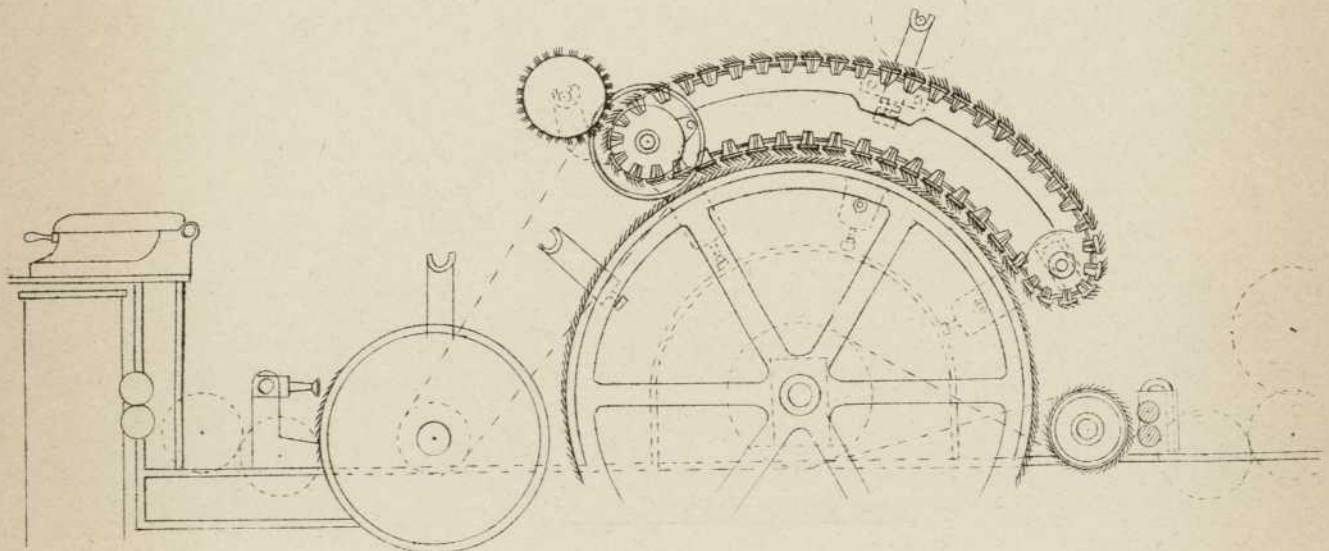


Fig. 114

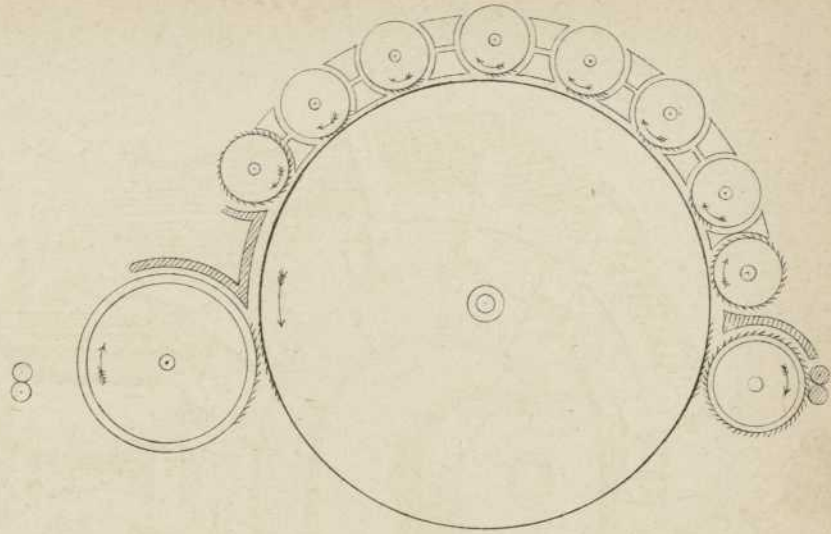


Fig. 115

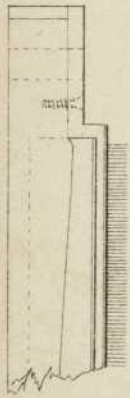
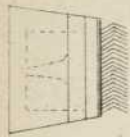


Fig. 116

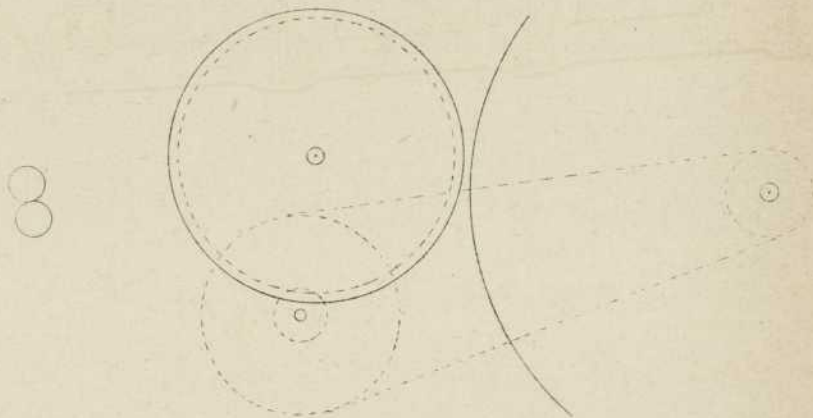


Fig. 117

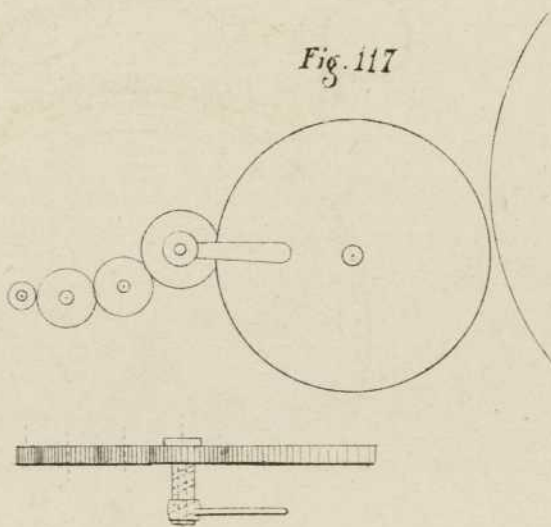


Fig. 118

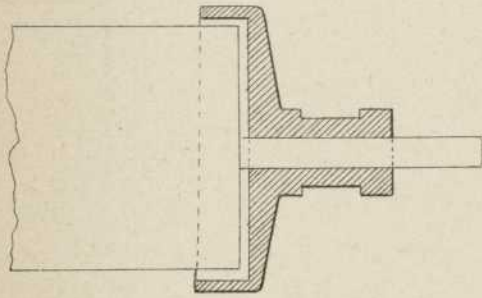


Fig. 119

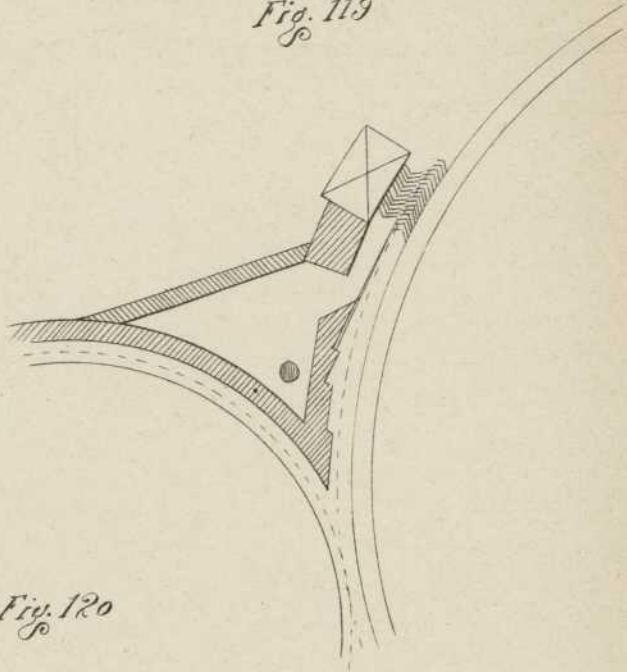
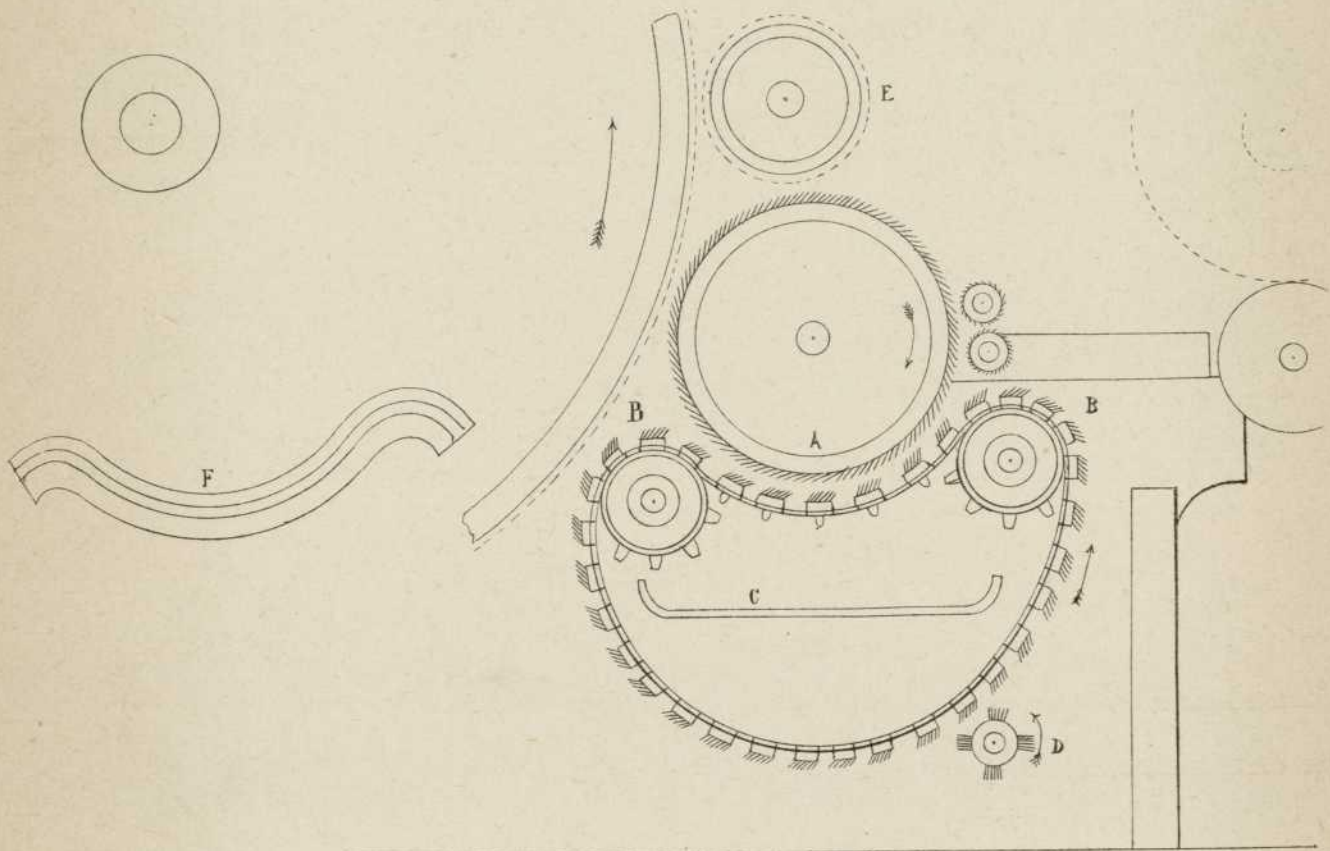


Fig. 120



AB

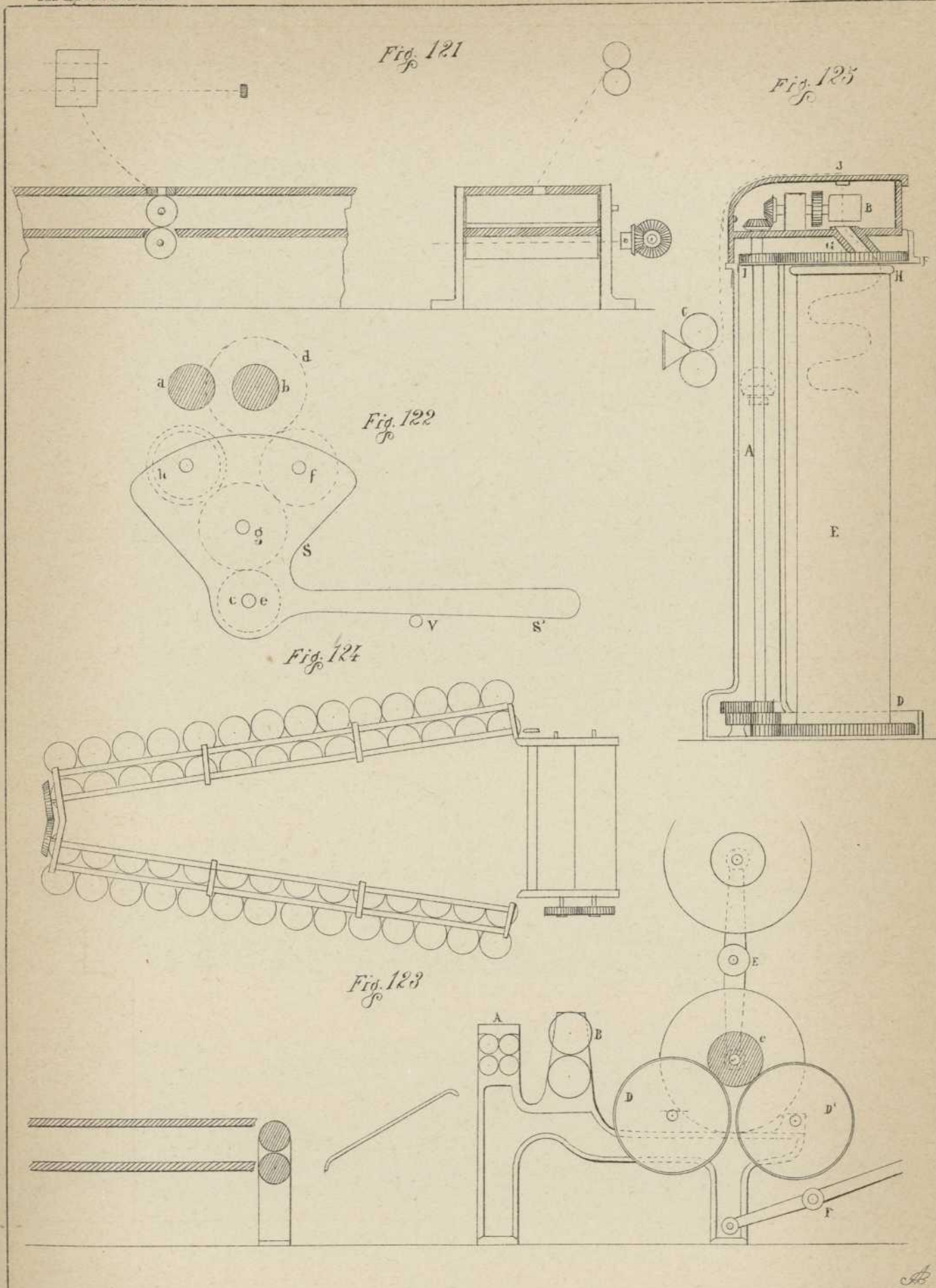


Fig. 126

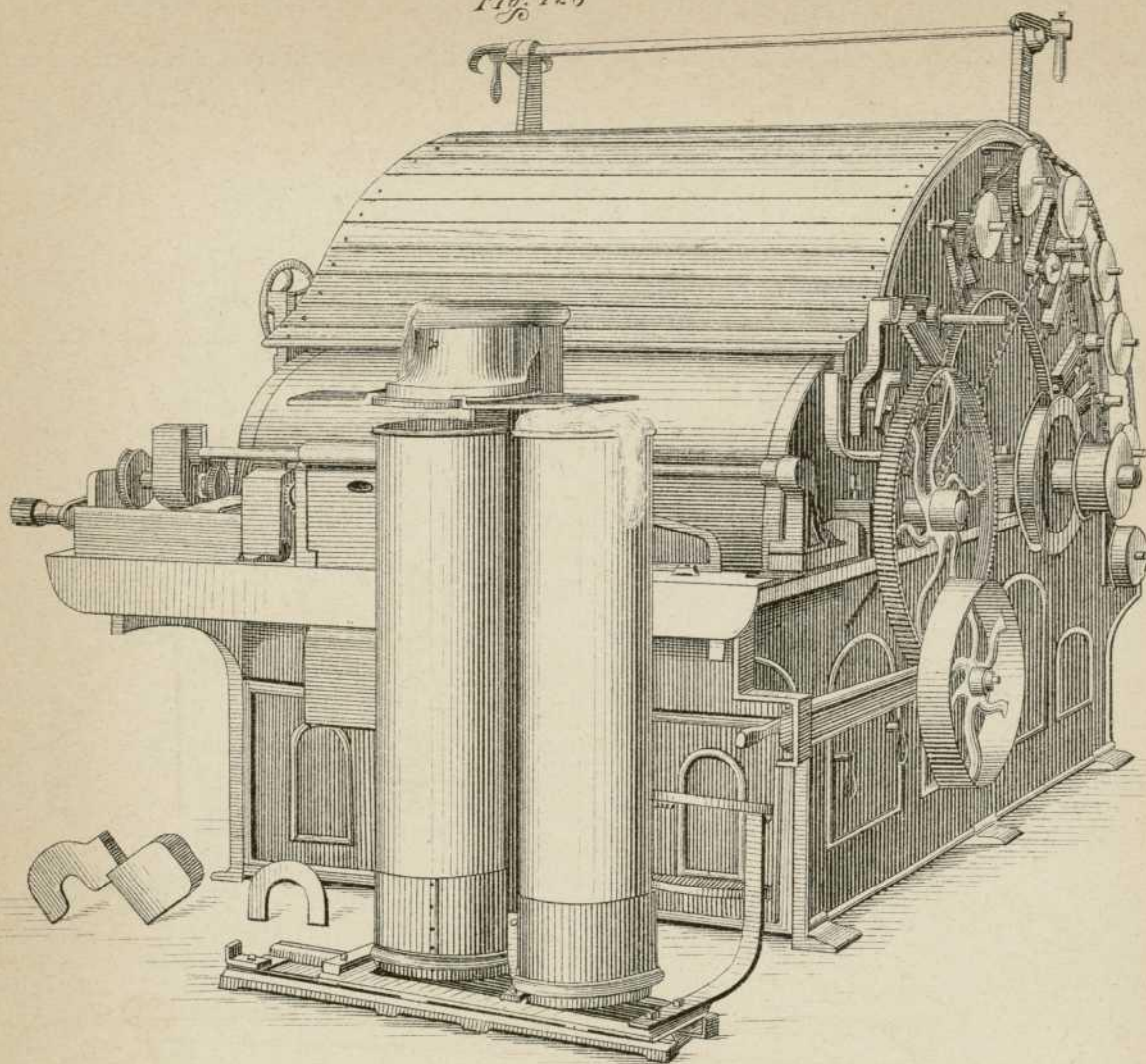
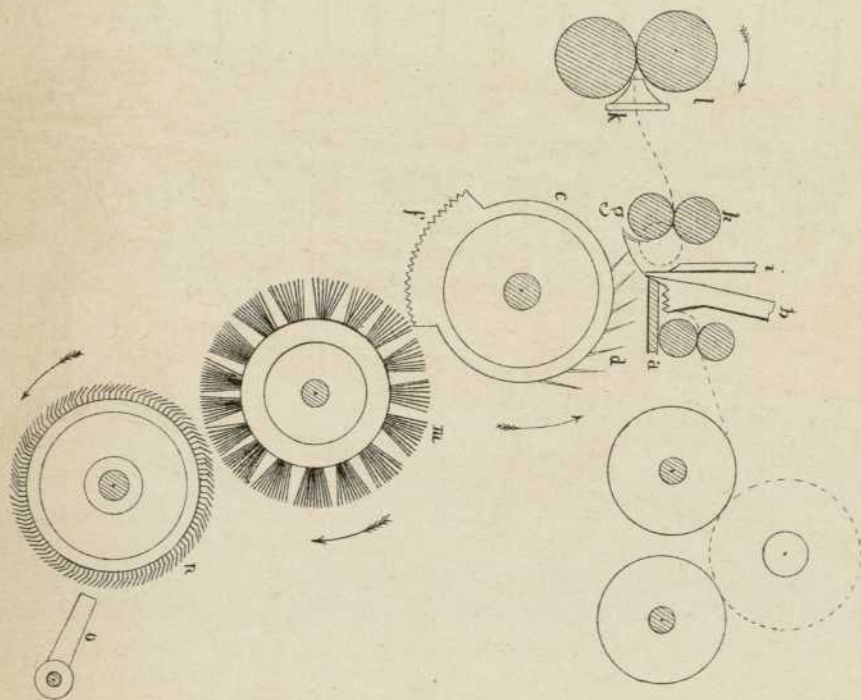


Fig. 127



5

Fig. 129

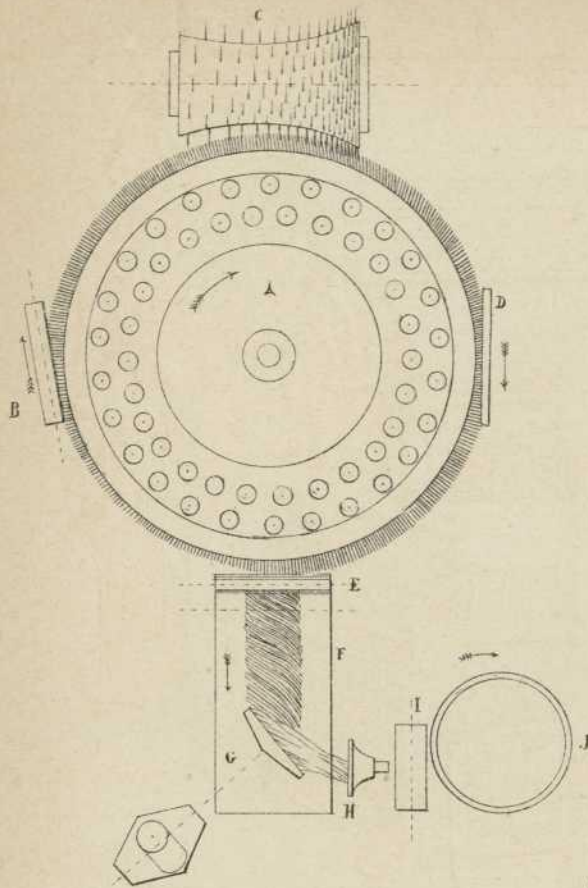


Fig. 130

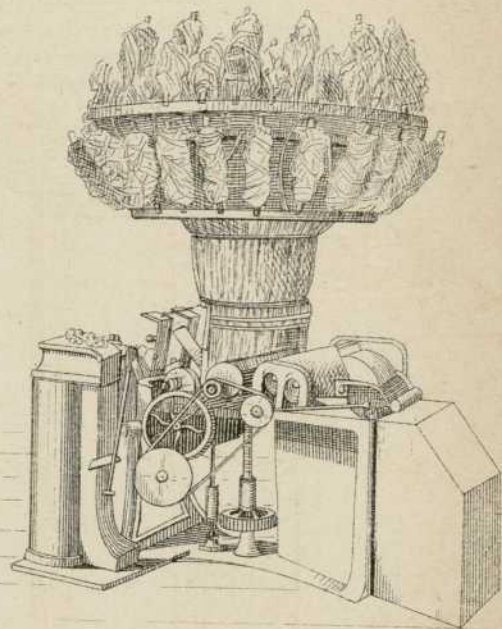


Fig. 128

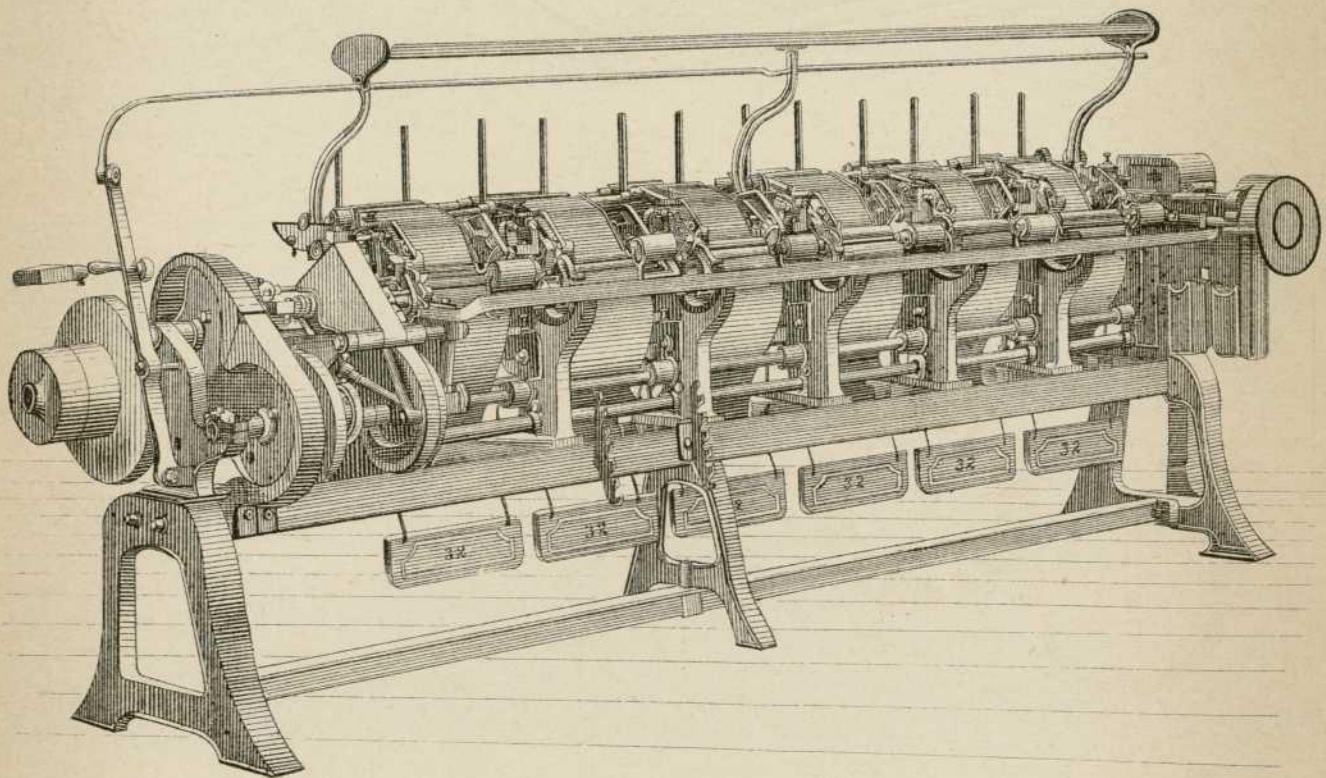


Fig. 131

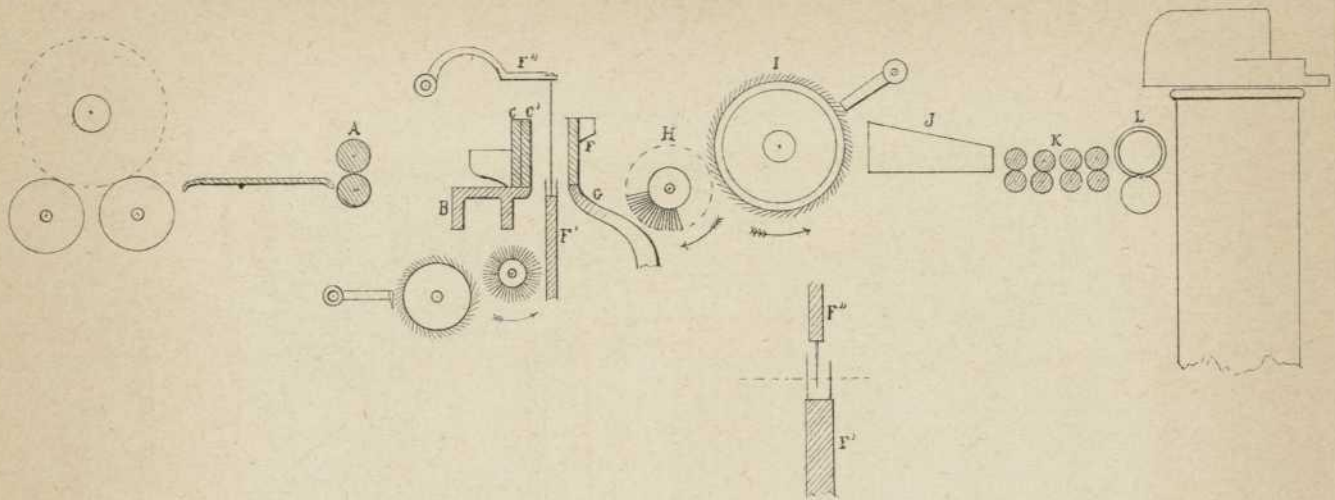


Fig. 132

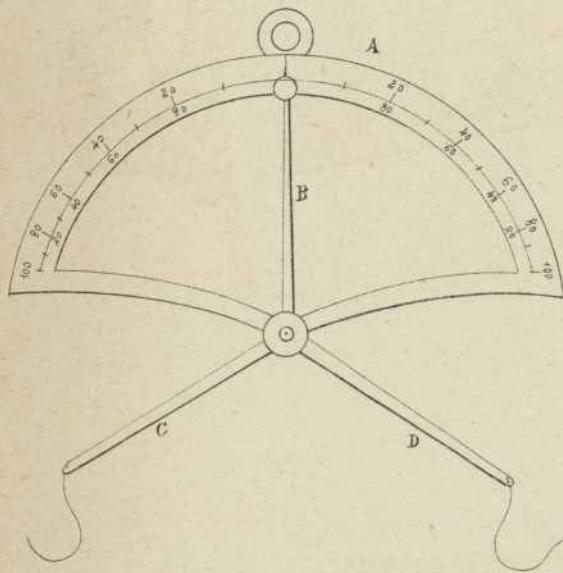


Fig. 134

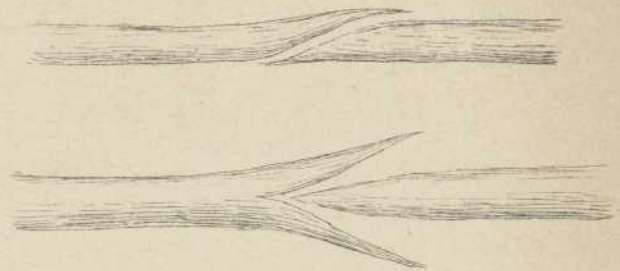


Fig. 133

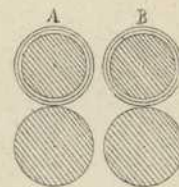


Fig. 135

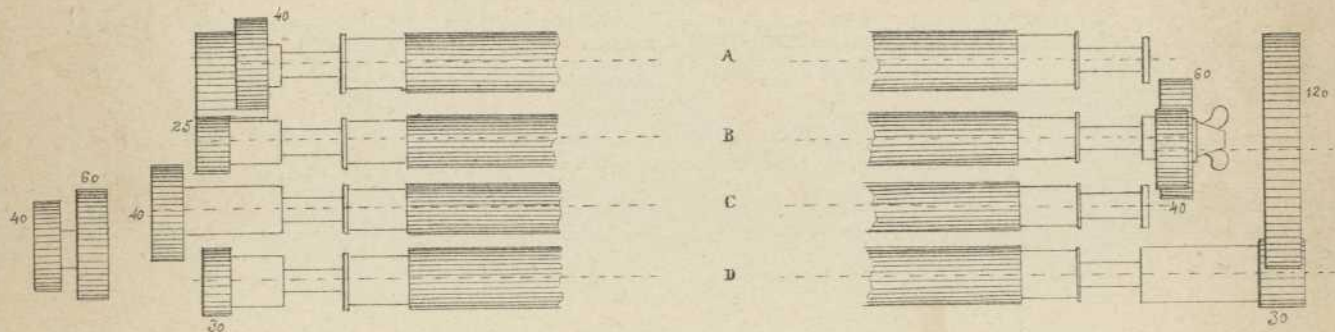


Fig. 136

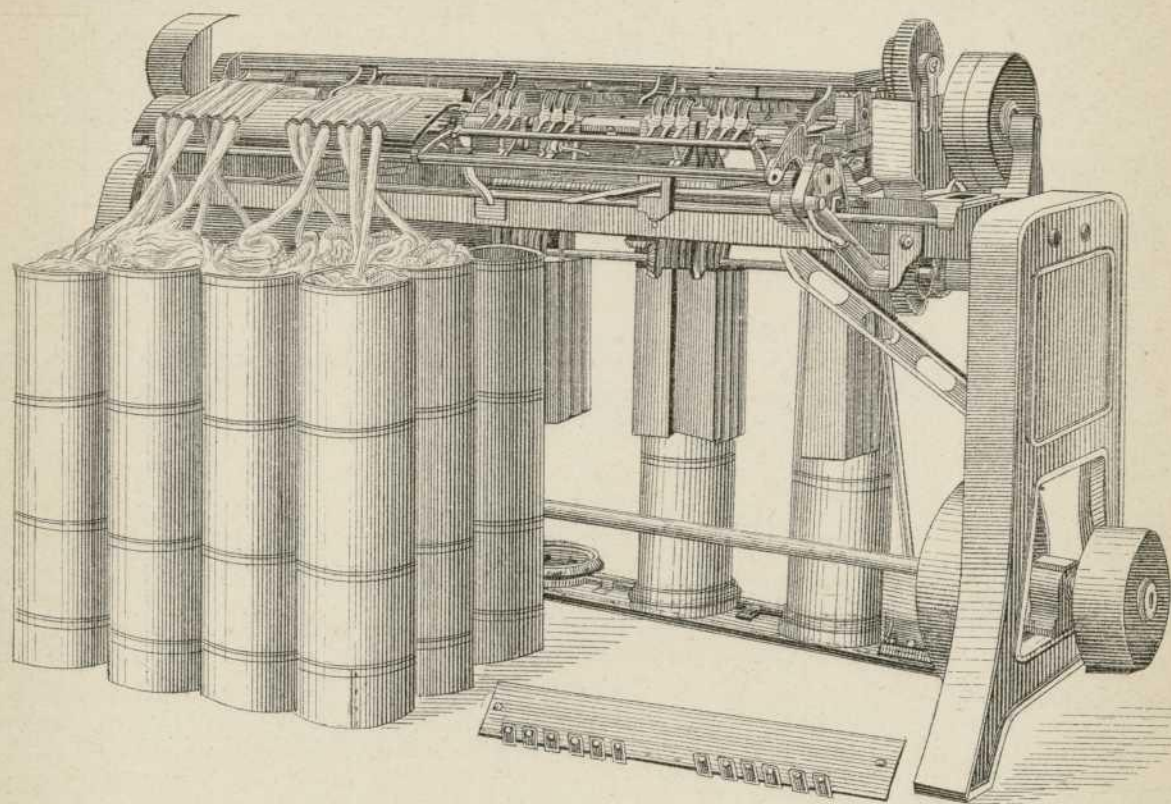


Fig. 137

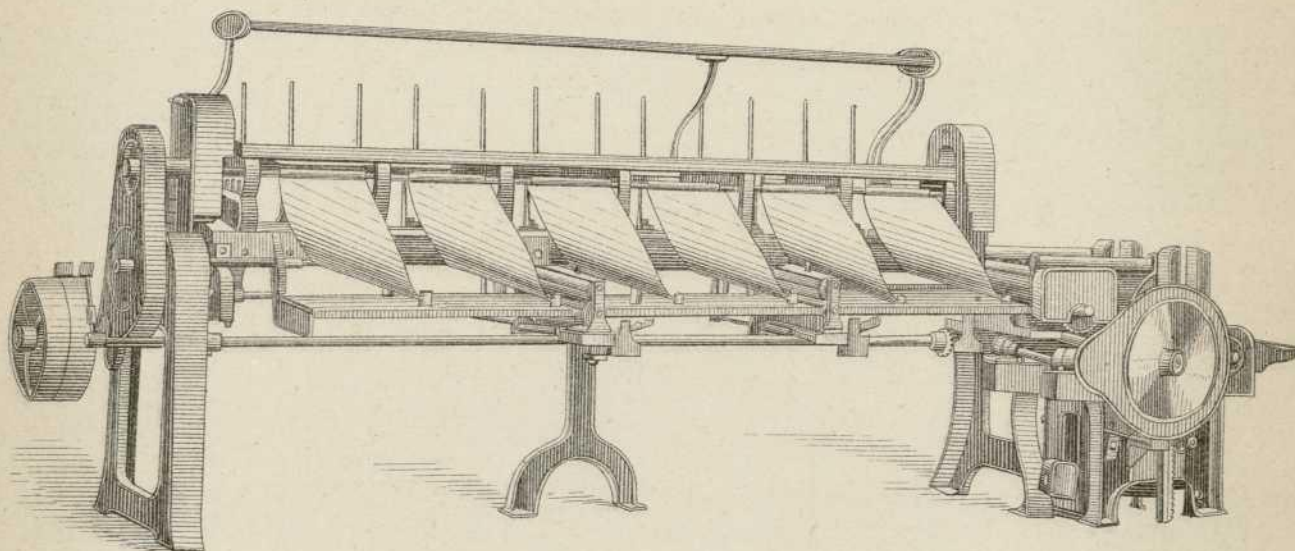


Fig. 138.

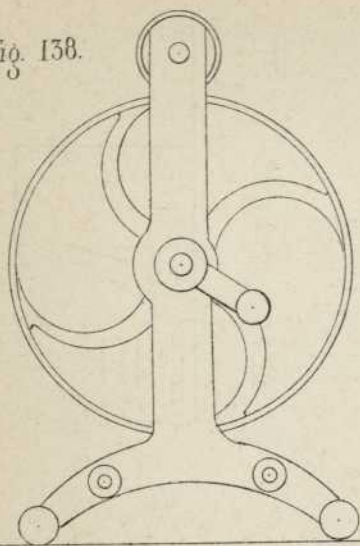


Fig. 139.

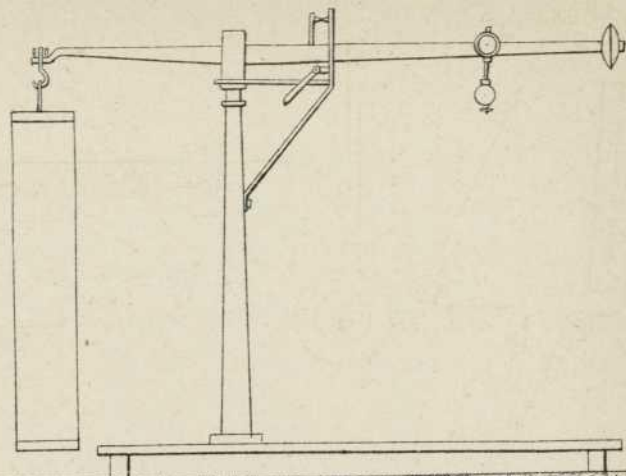


Fig. 140.

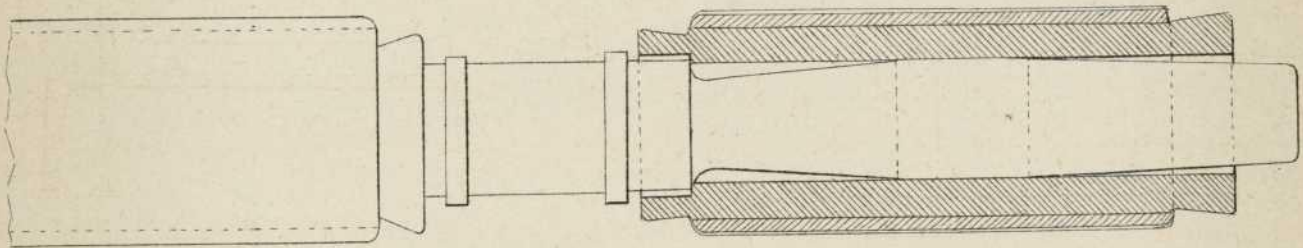
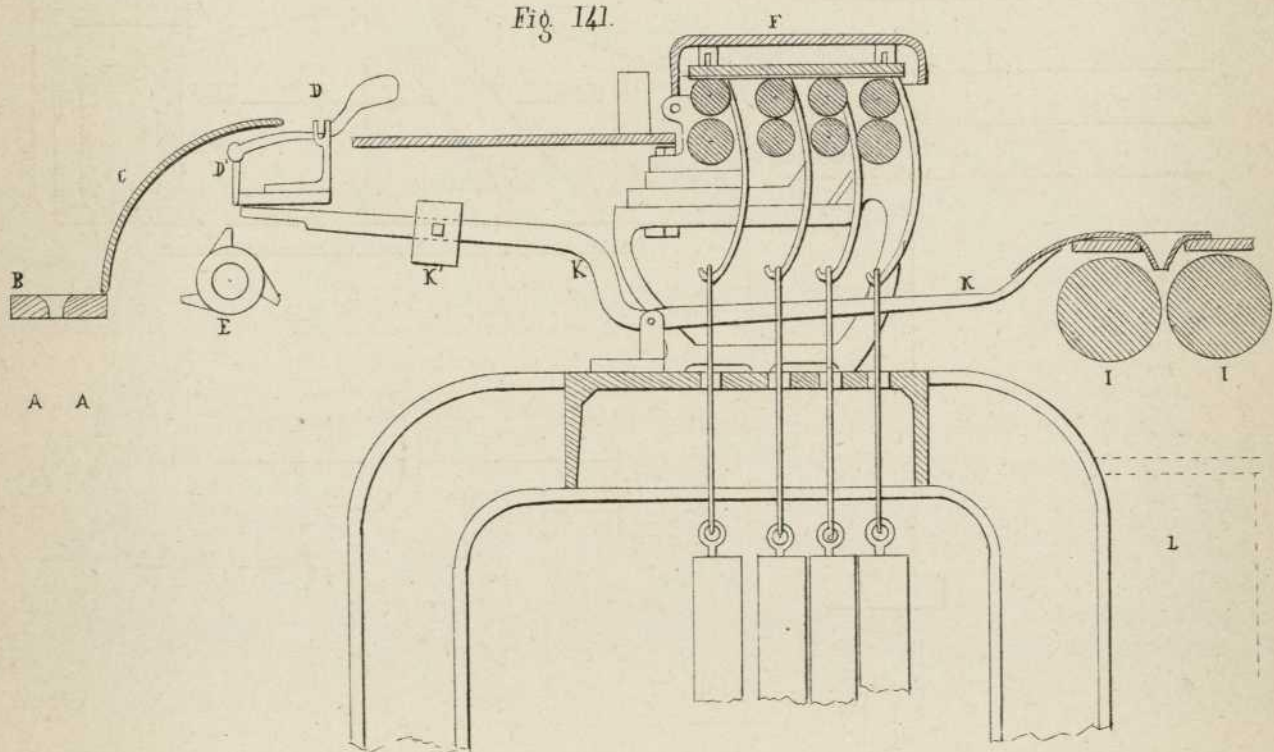


Fig. 141.



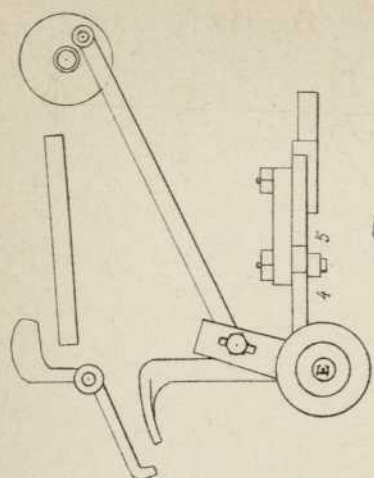


Fig. 143.

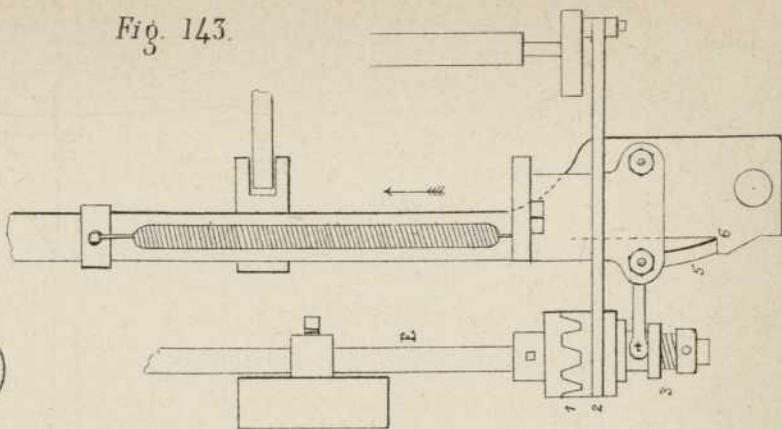


Fig. 142.

Fig. 145.

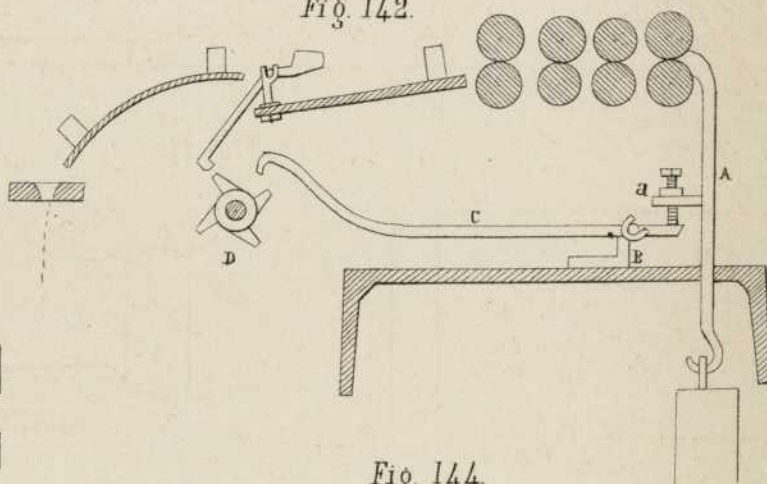
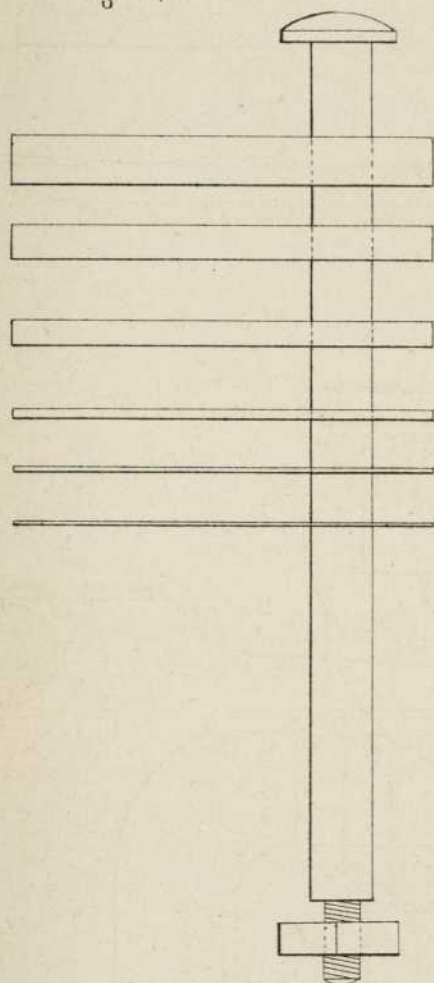


Fig. 144.

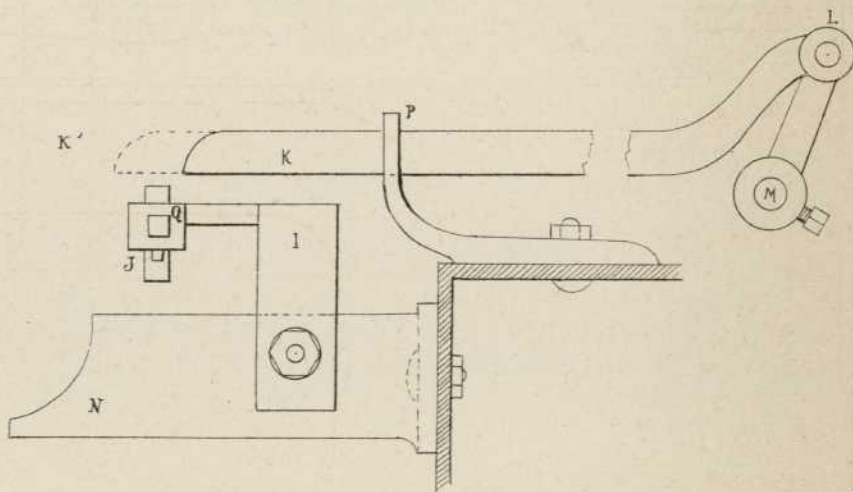
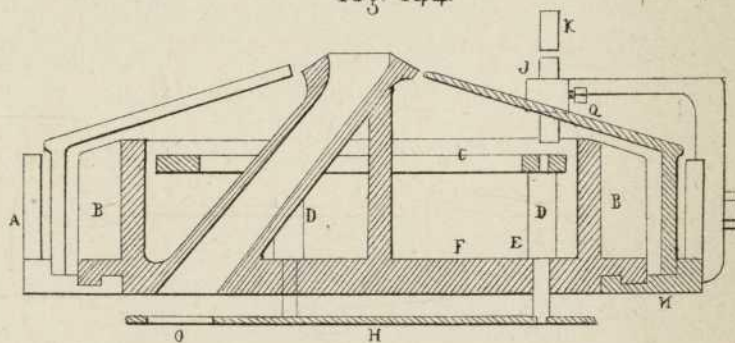


Fig. 148.

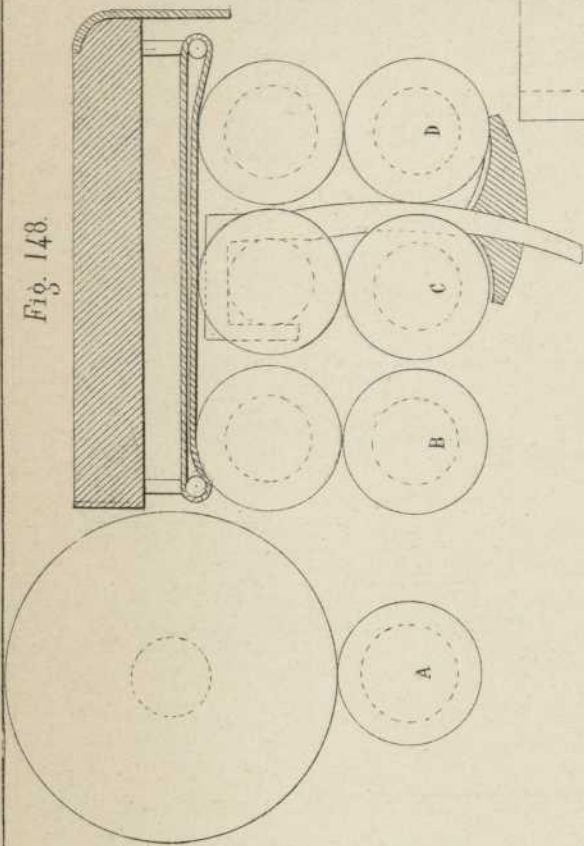


Fig. 146.

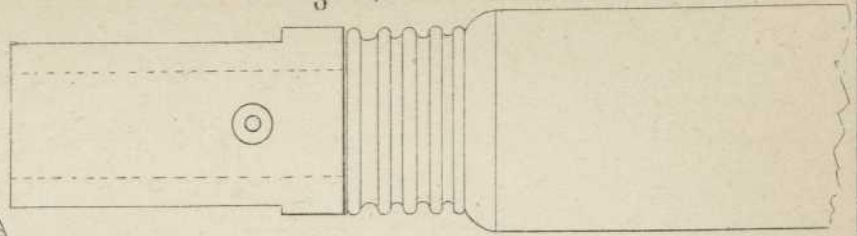


Fig. 150.

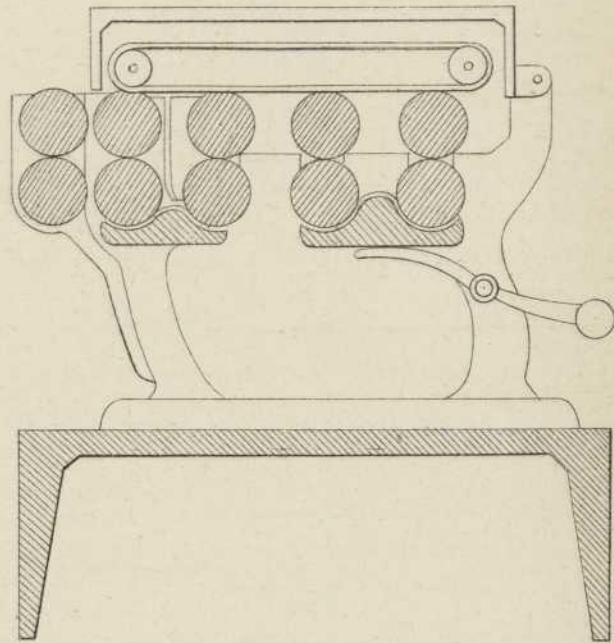


Fig. 147.

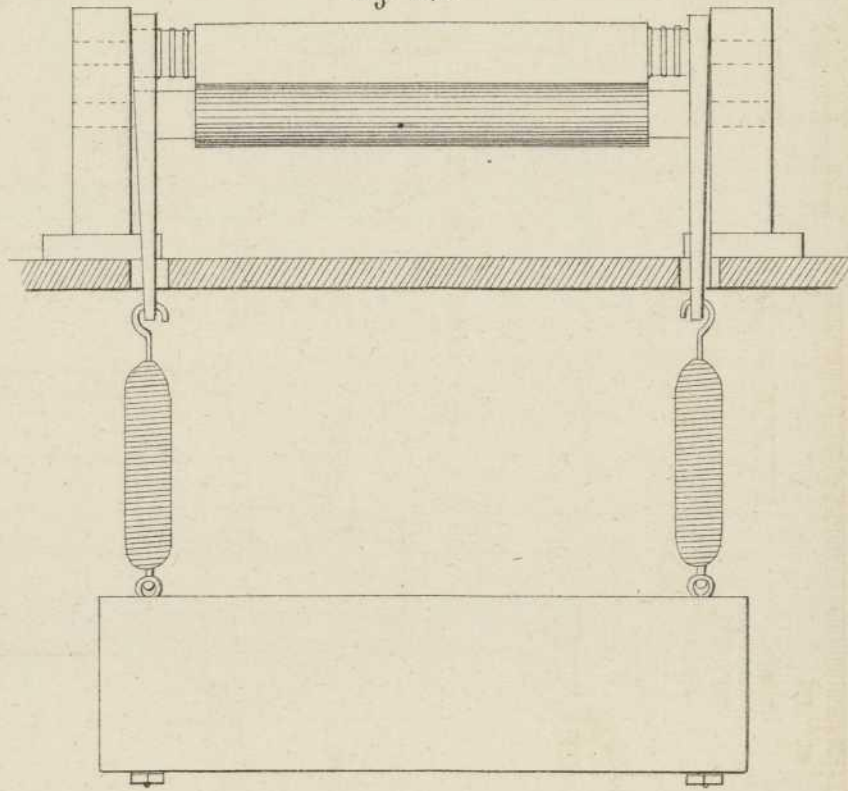


Fig. 149.

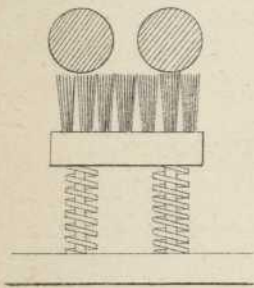


Fig. 151

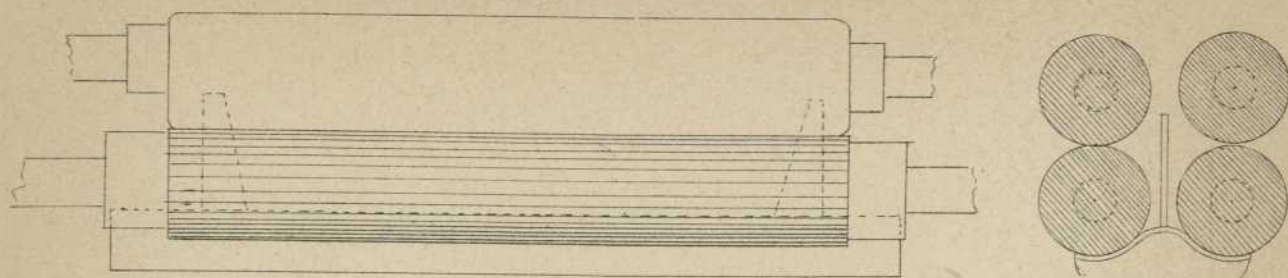


Fig. 153

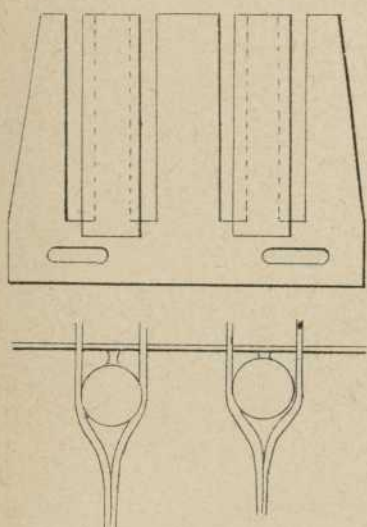


Fig. 152

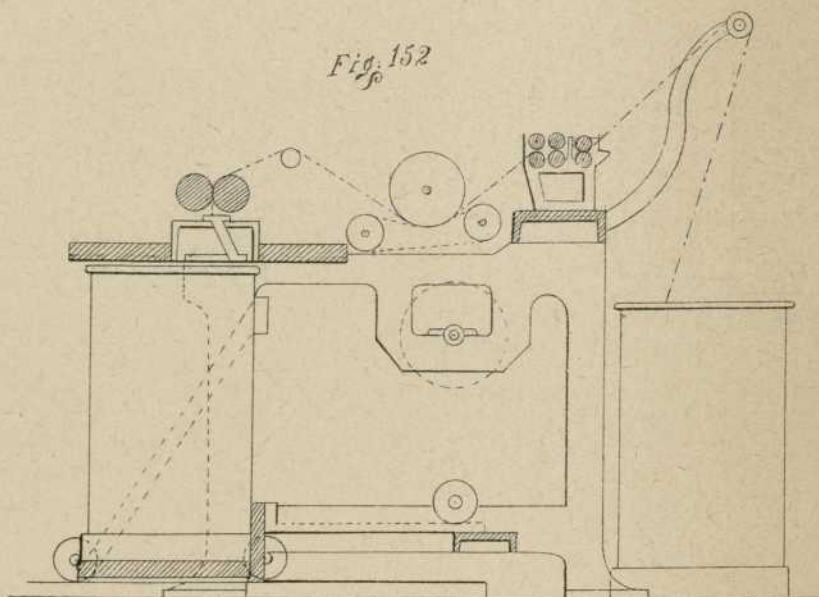


Fig. 154

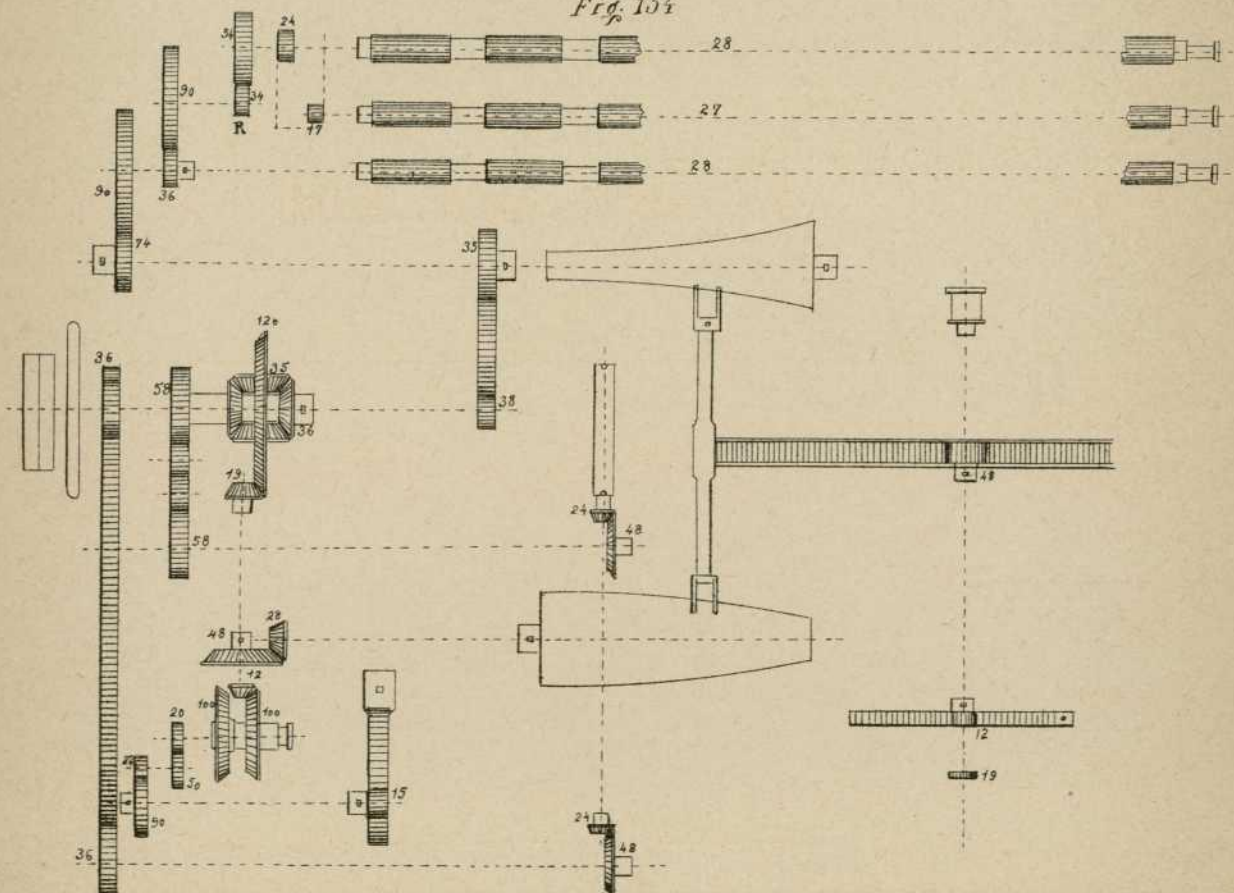


Fig. 135

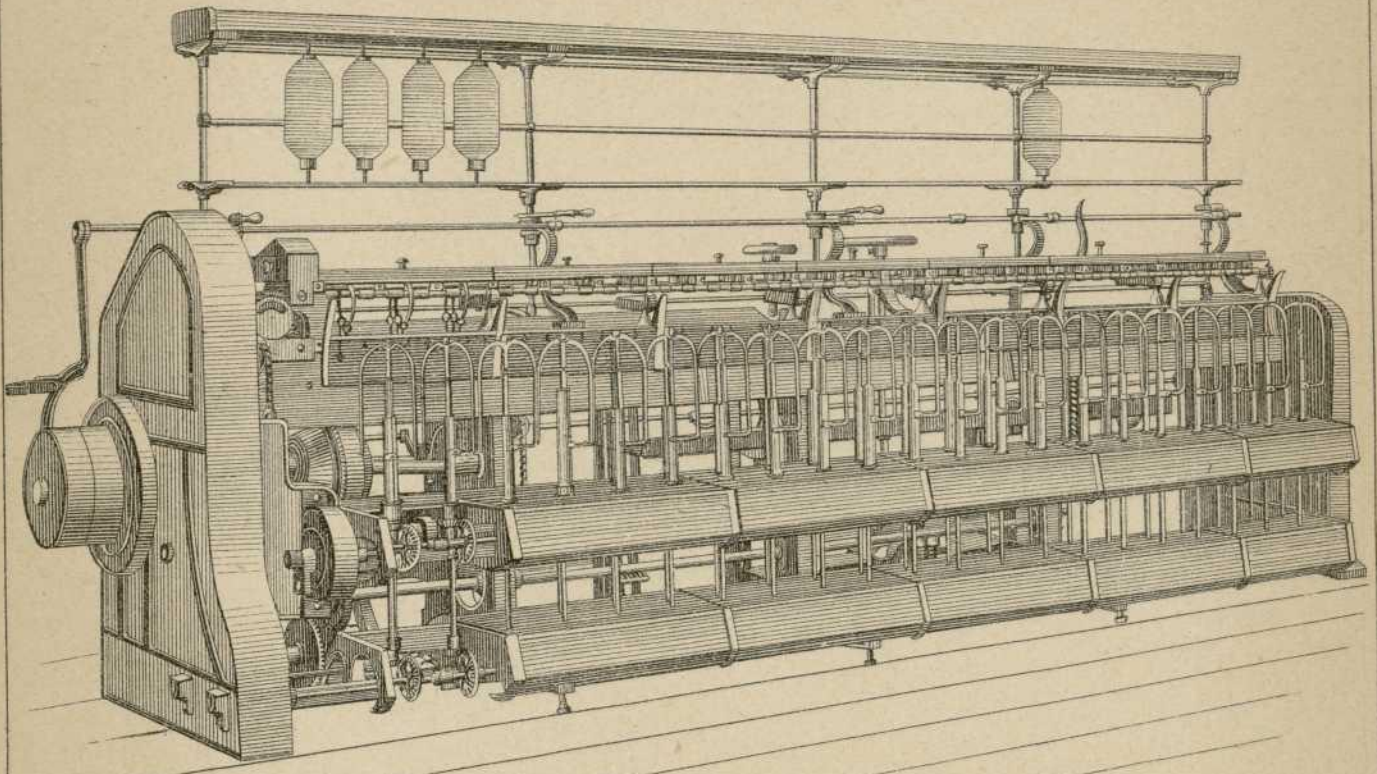


Fig. 136

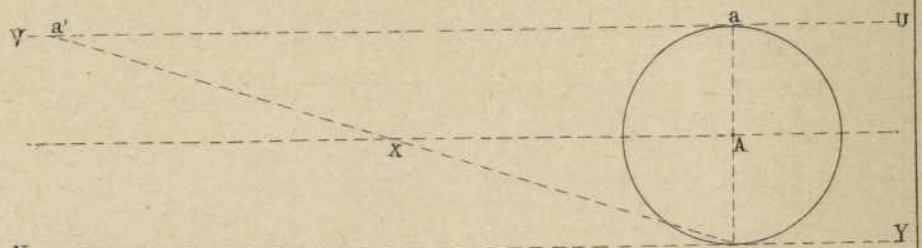


Fig. 137

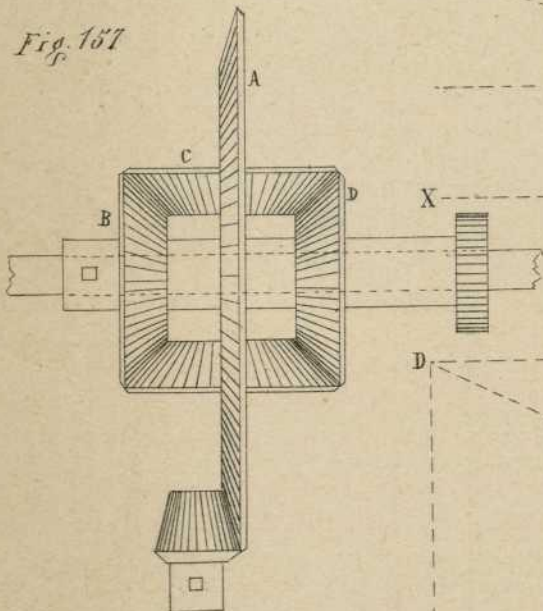


Fig. 138

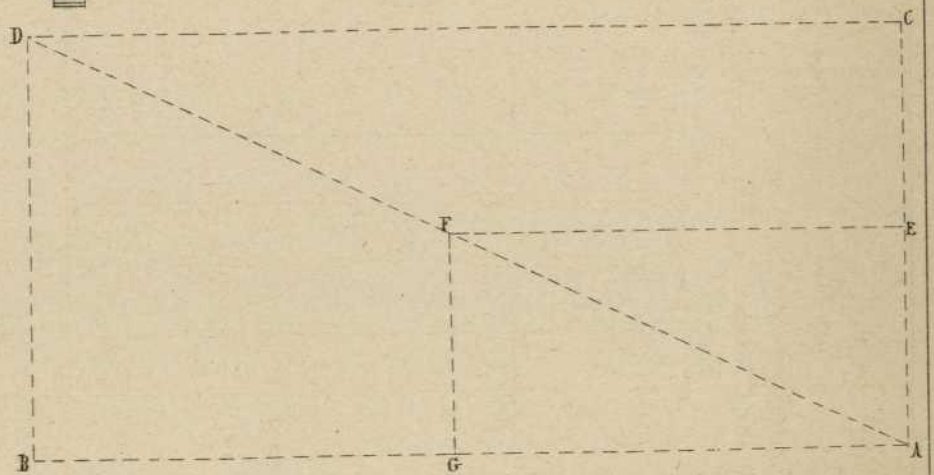


Fig. 159.

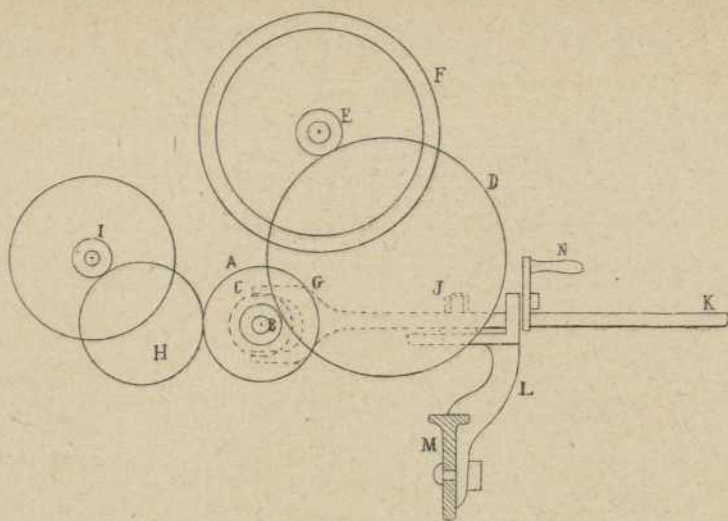


Fig. 161

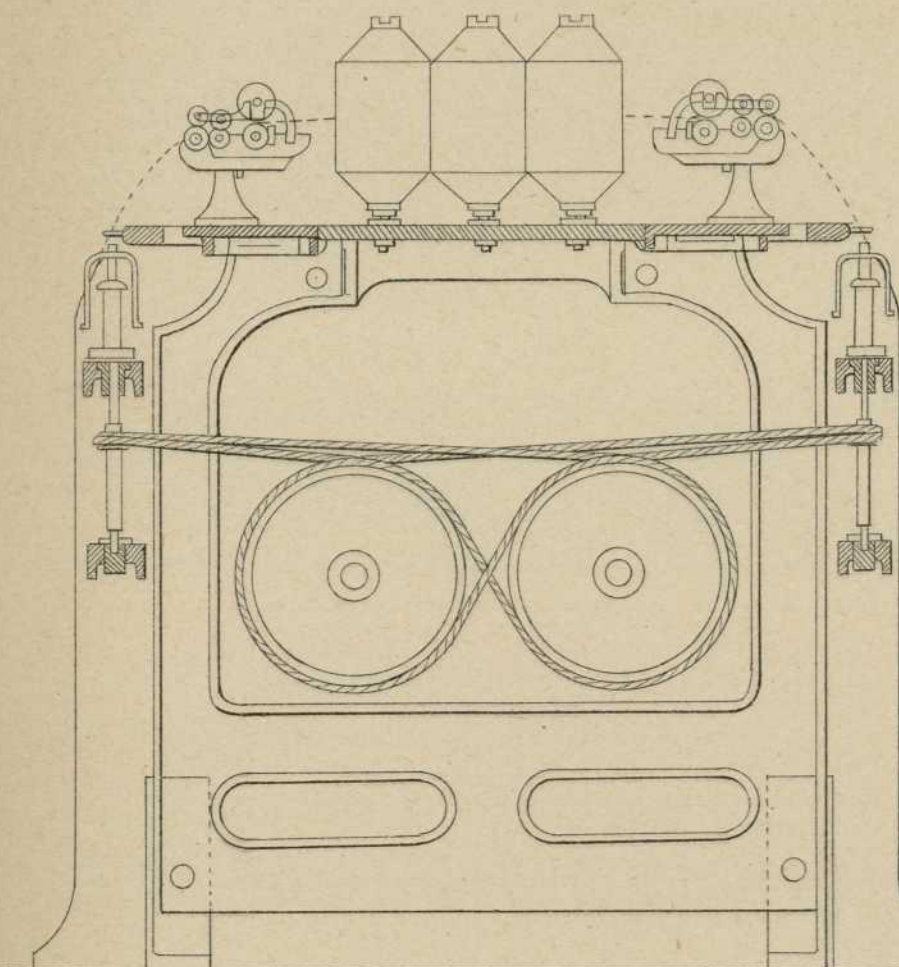
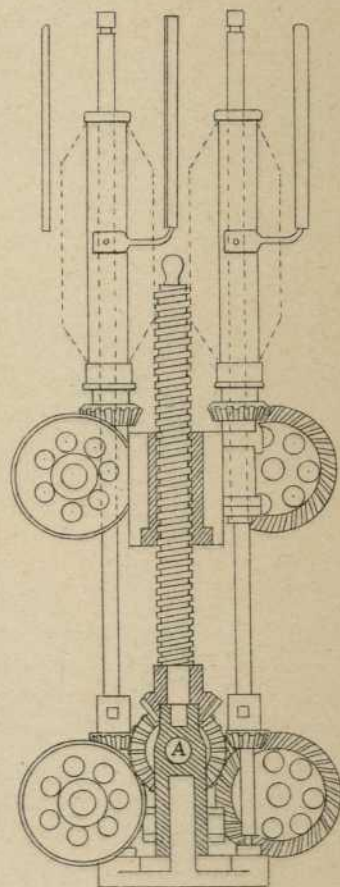


Fig. 160



Ad

Fig. 162

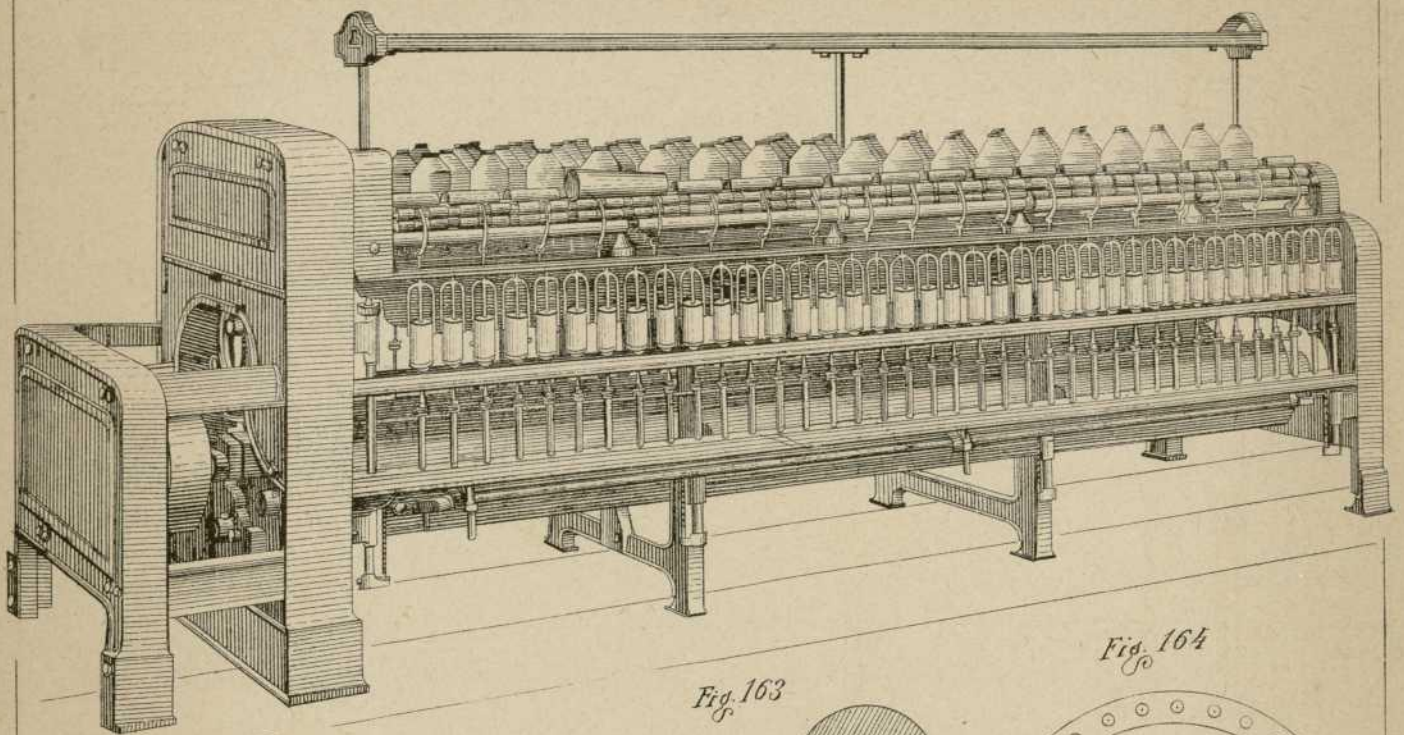


Fig. 163

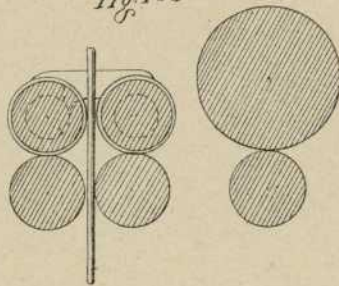


Fig. 164

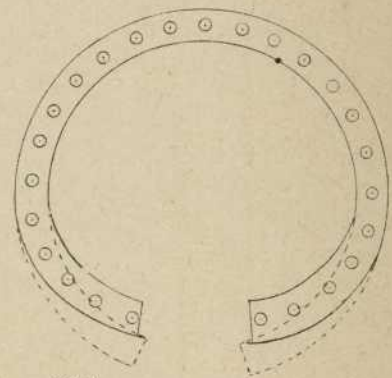


Fig. 166

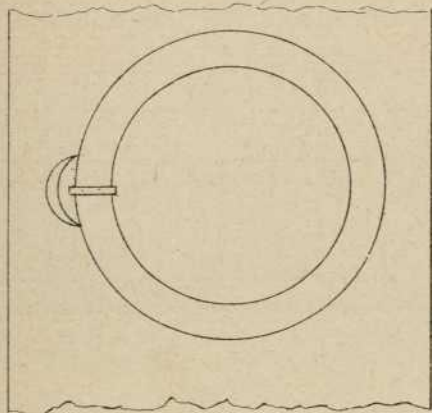
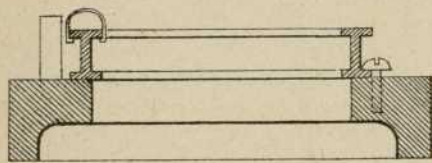


Fig. 165

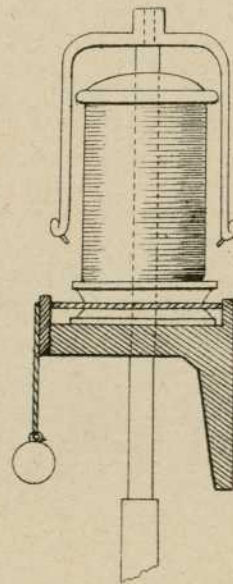


Fig. 168

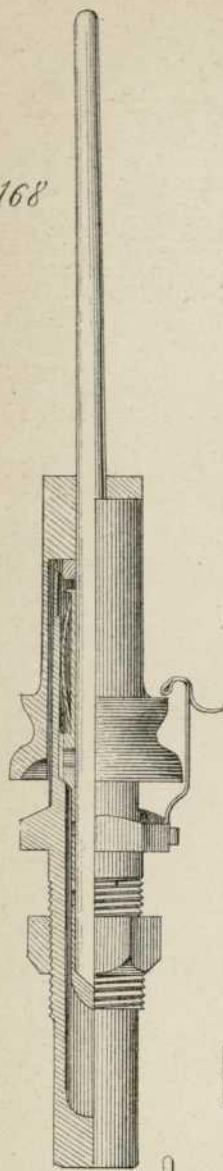


Fig. 167

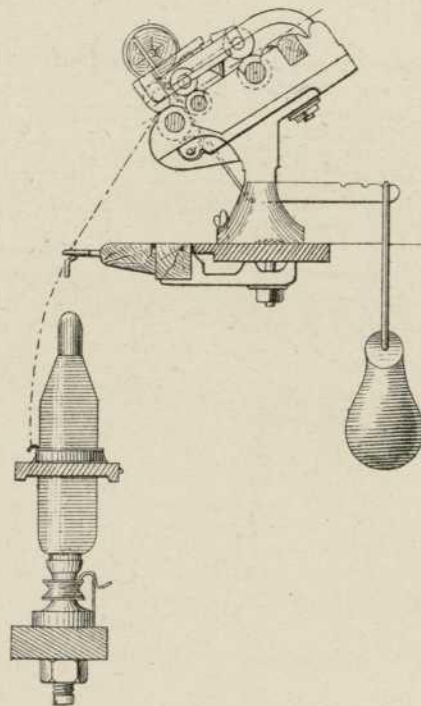


Fig. 169

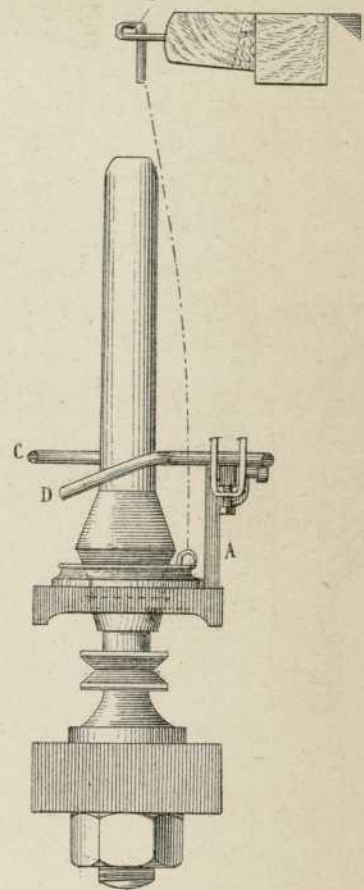


Fig. 170

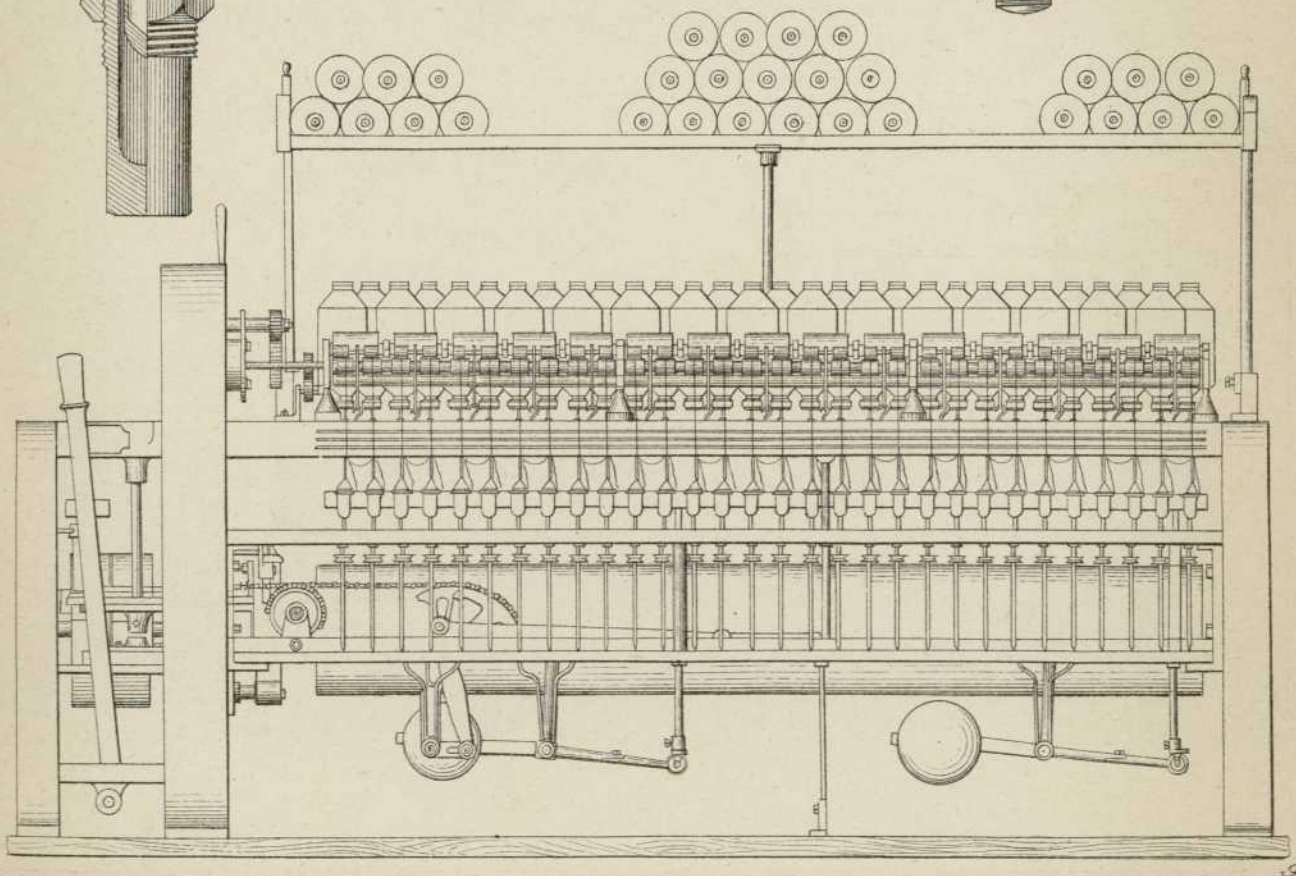


Fig. 171

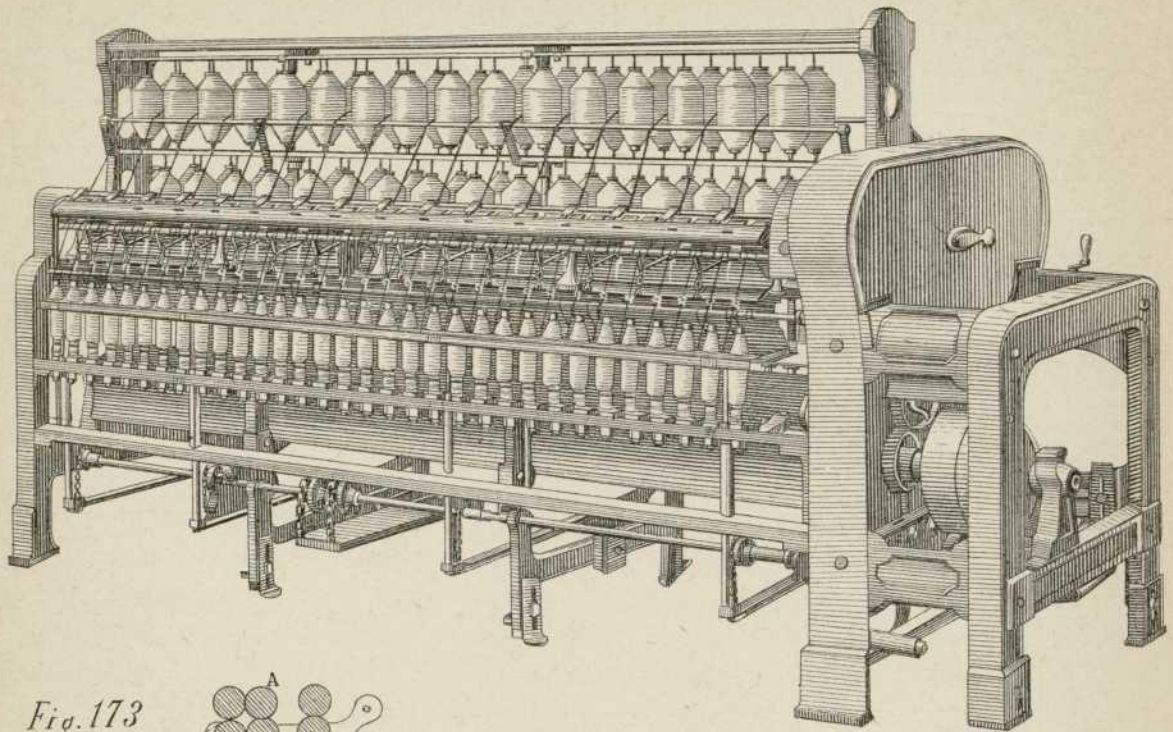


Fig. 173

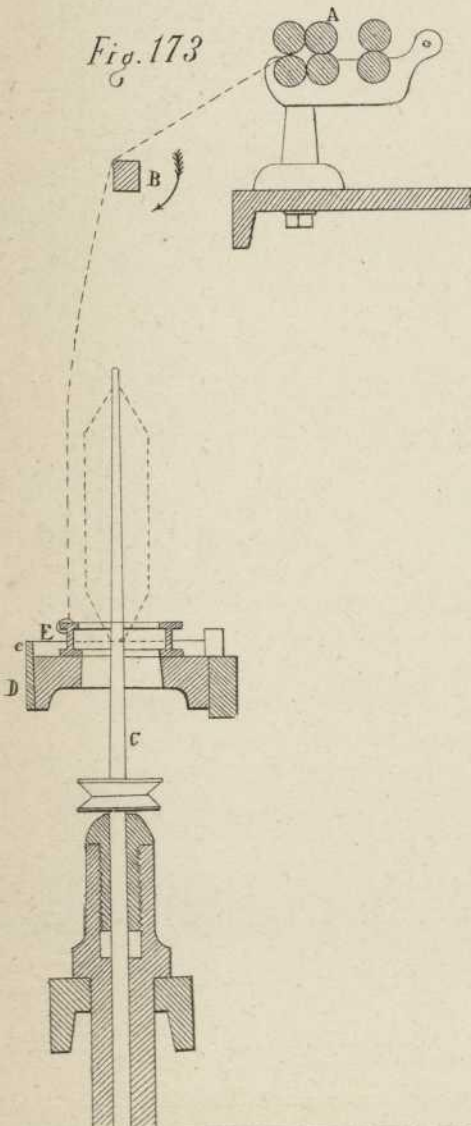


Fig. 172

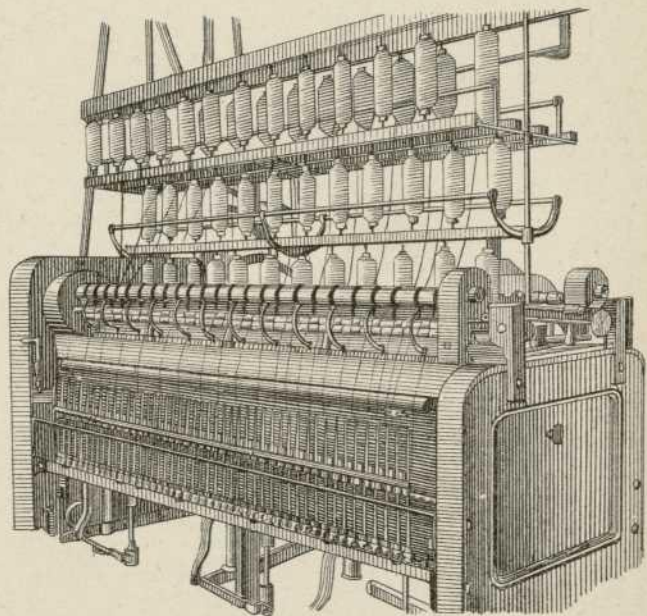


Fig. 174

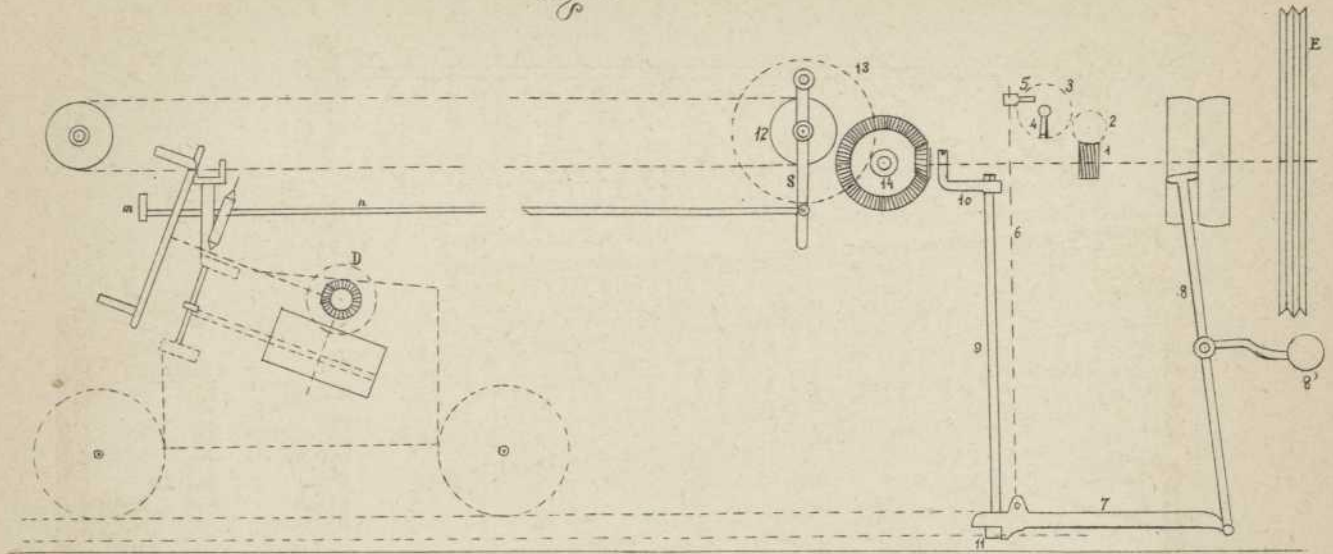


Fig. 175

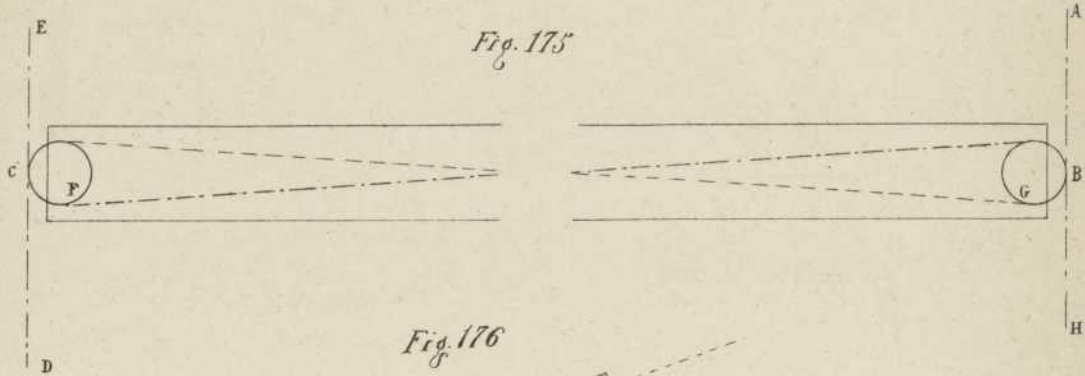


Fig. 176

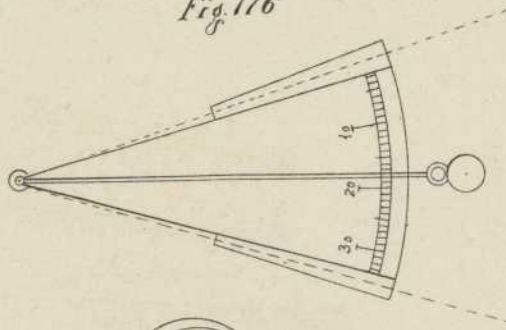


Fig. 177

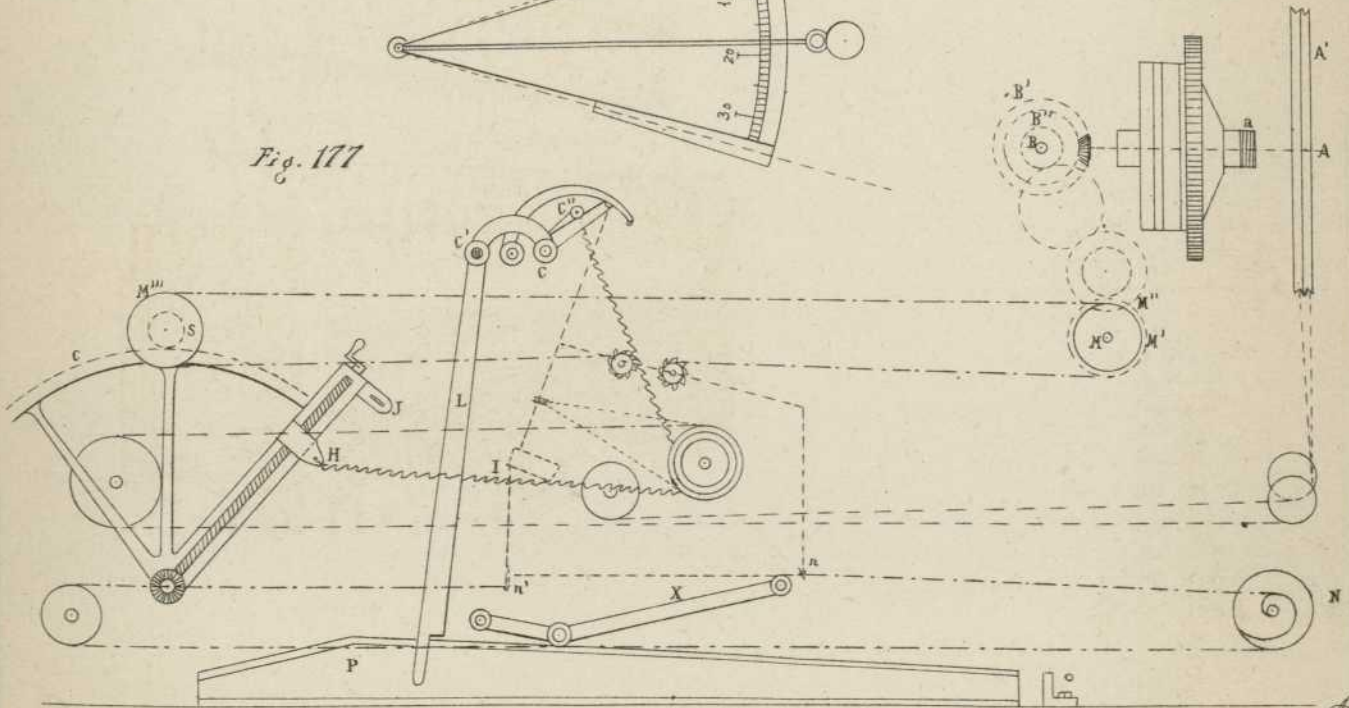


Fig. 178

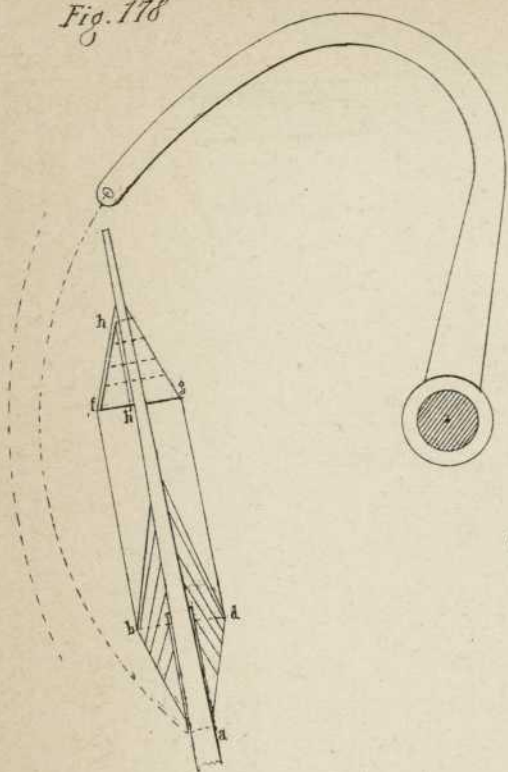


Fig. 180

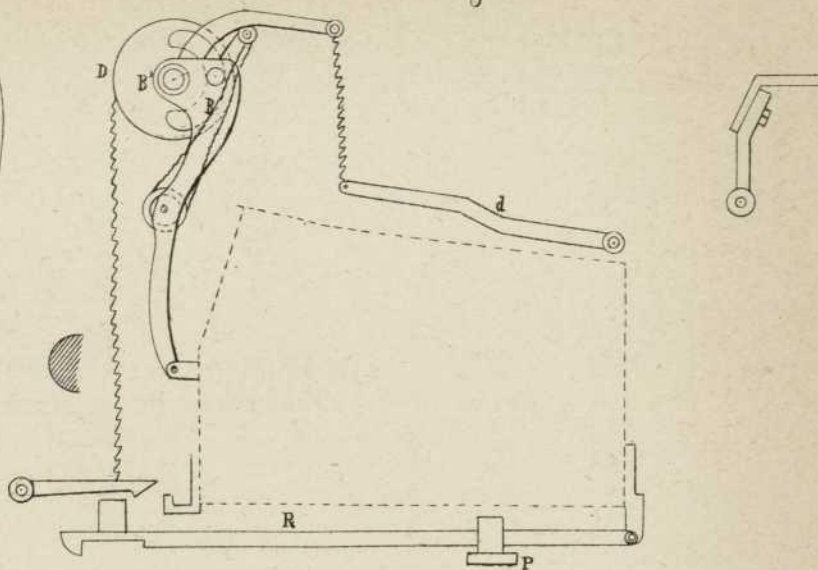


Fig. 182

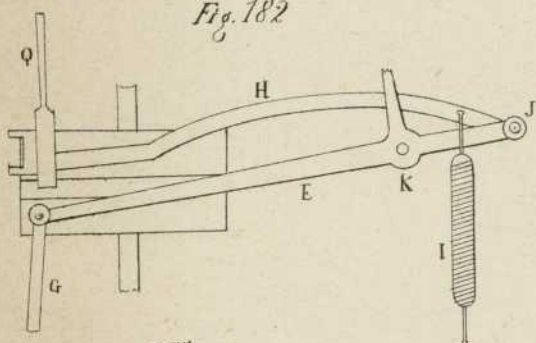


Fig. 181

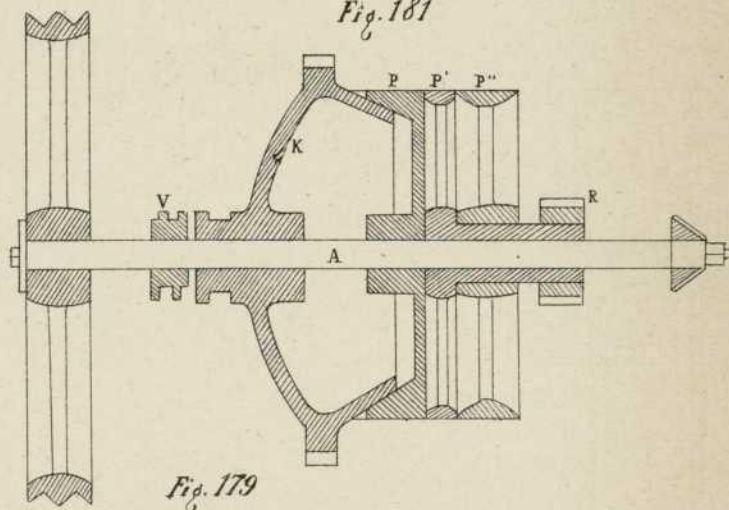
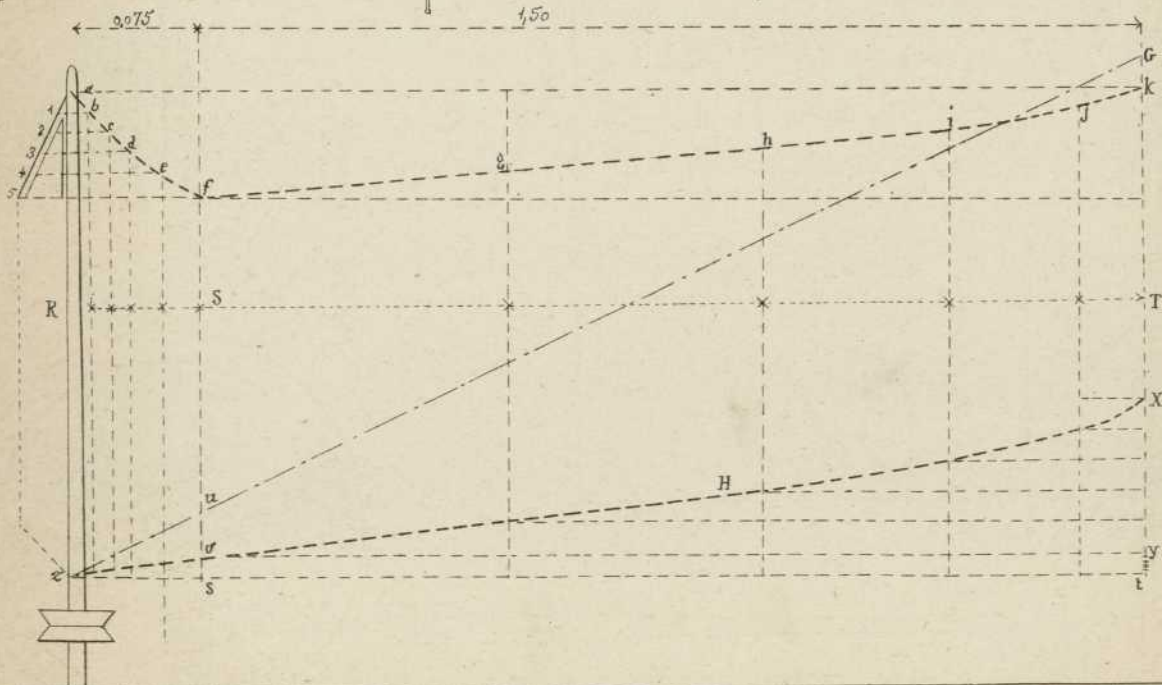


Fig. 179



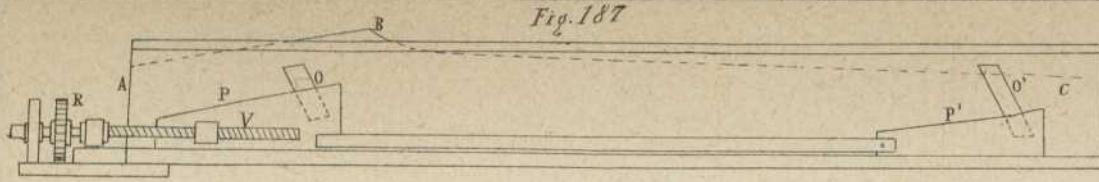


Fig. 187

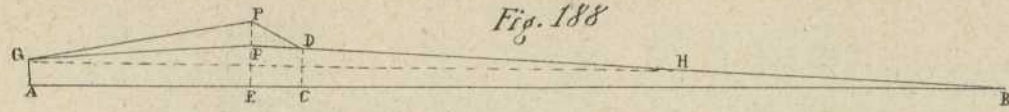


Fig. 188

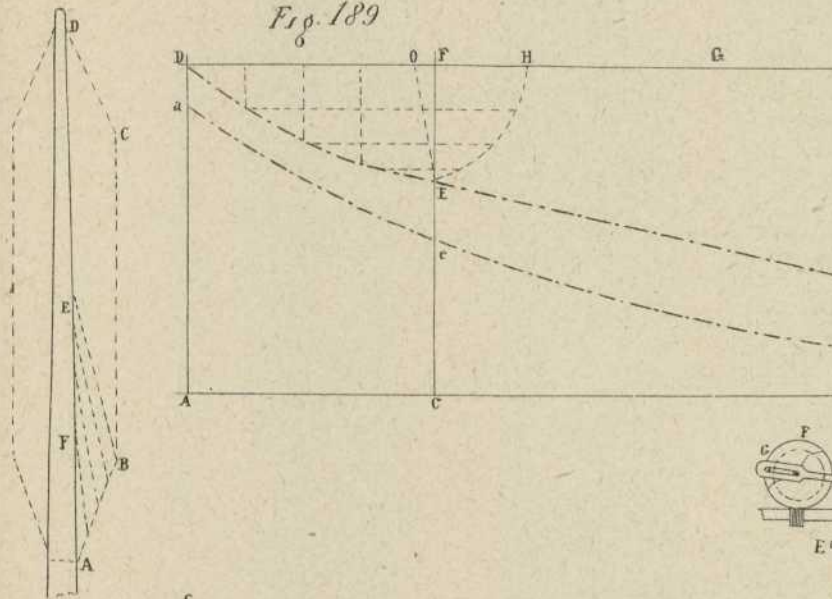


Fig. 189

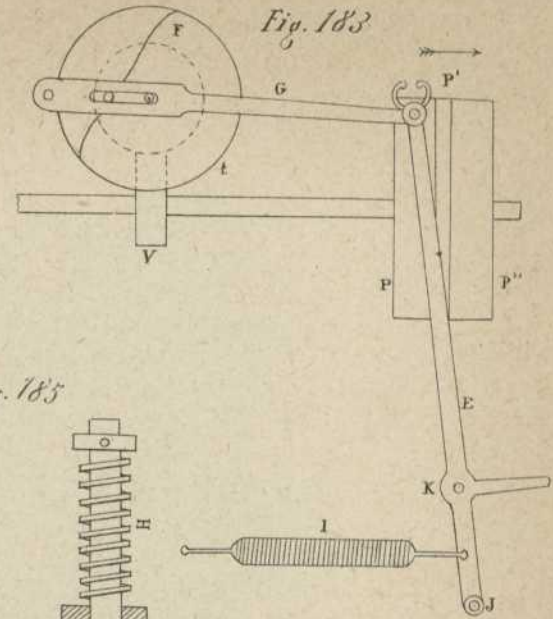


Fig. 183

Fig. 185

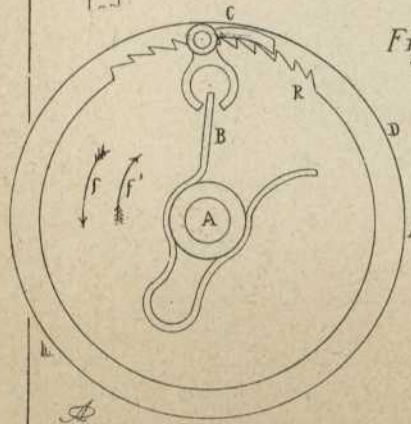
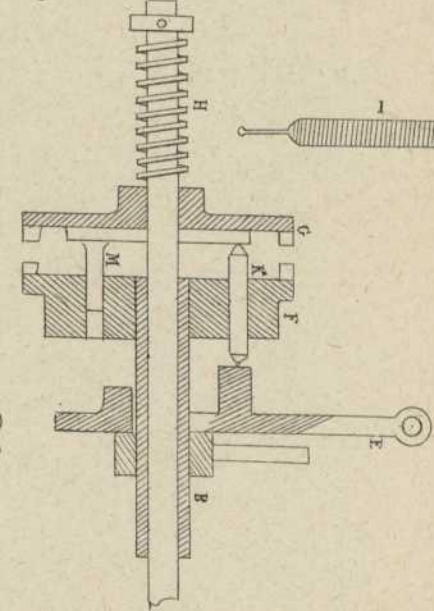
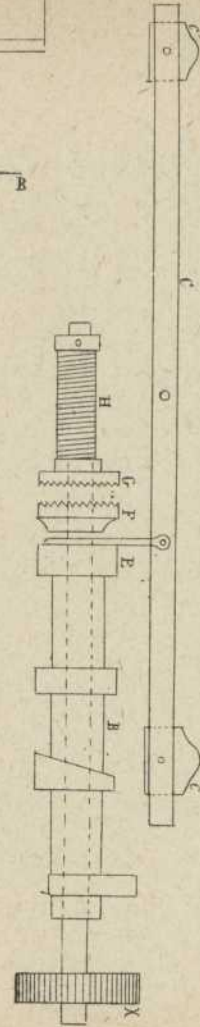


Fig. 186

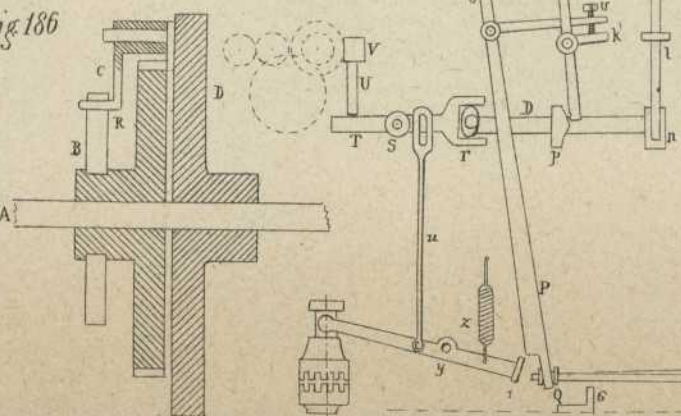


Fig. 181

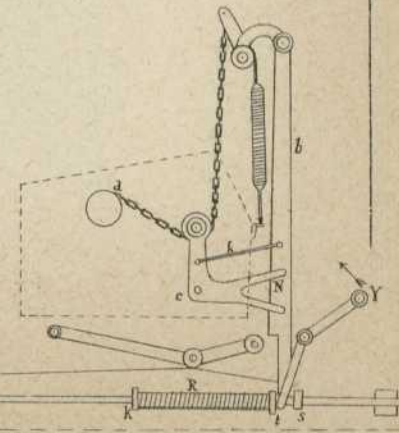


Fig. 190

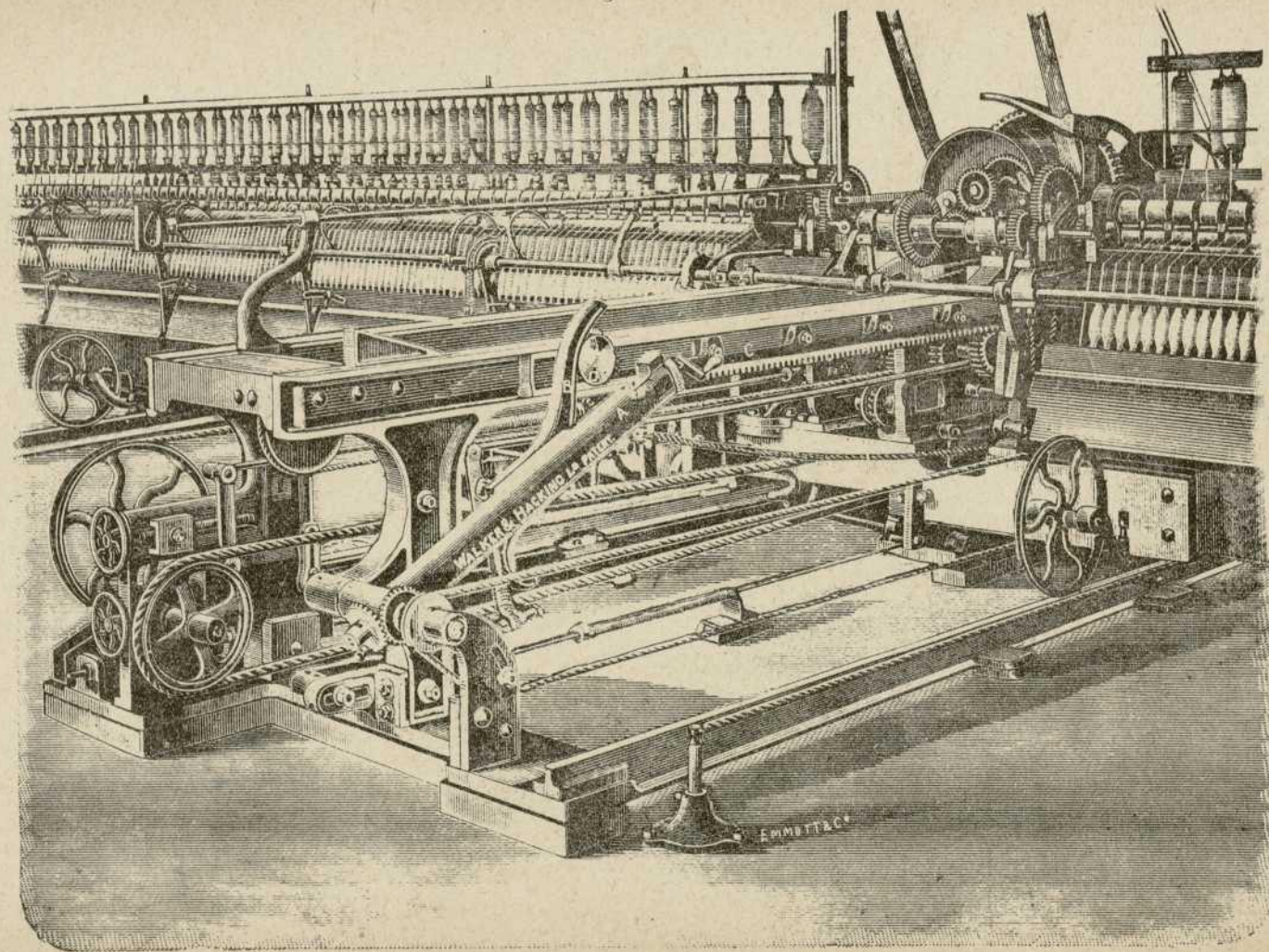
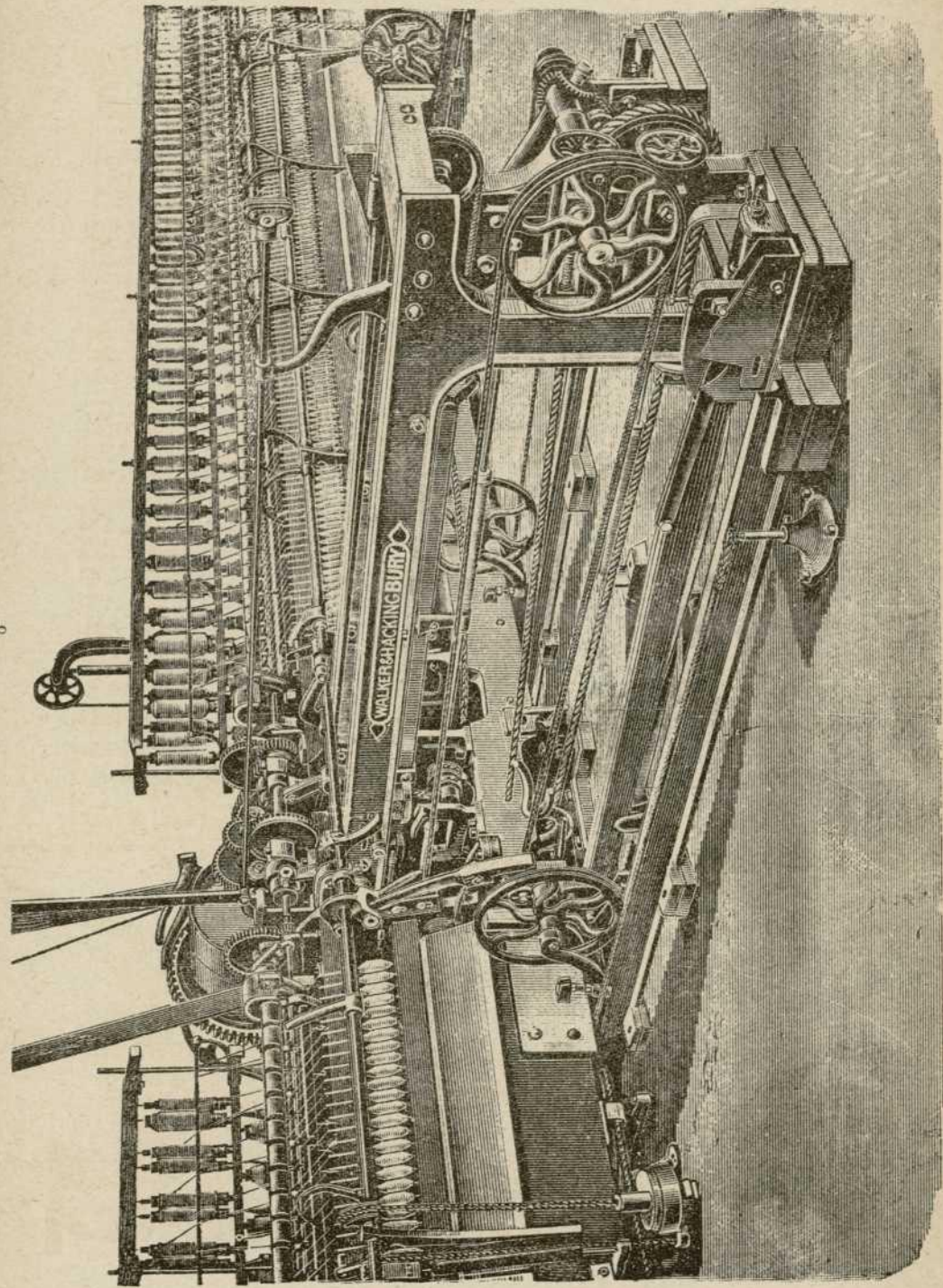


Fig. 191



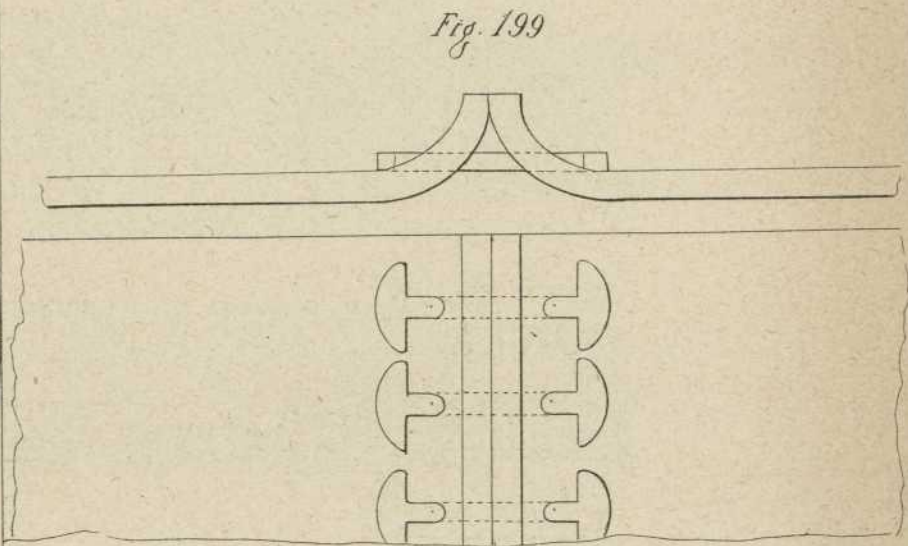
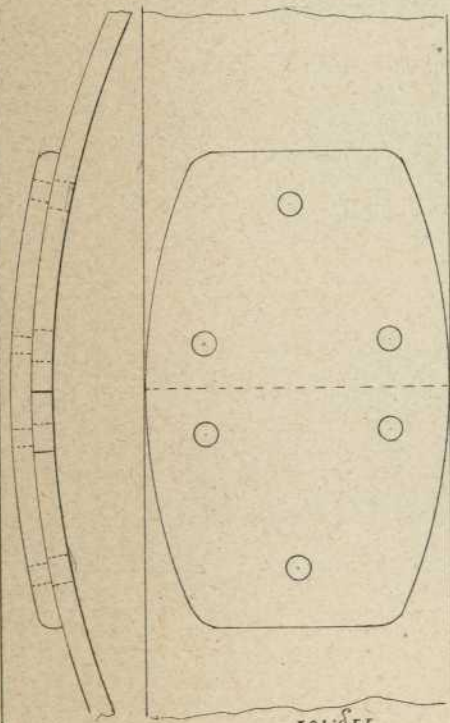
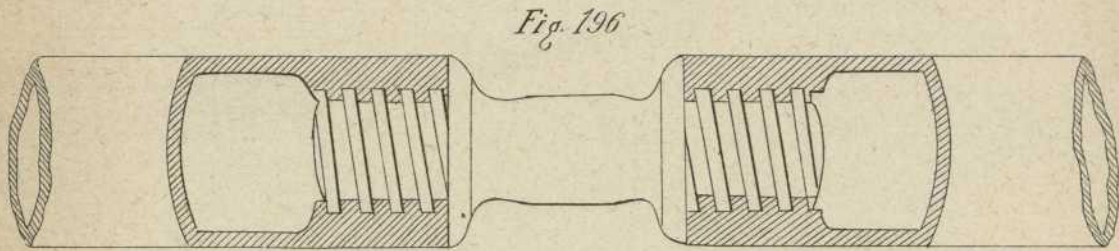
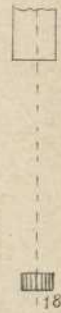
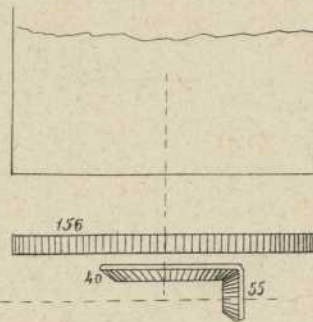
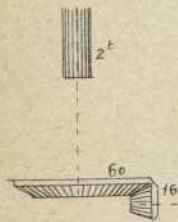
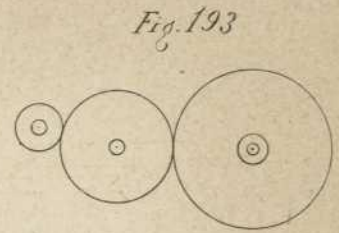
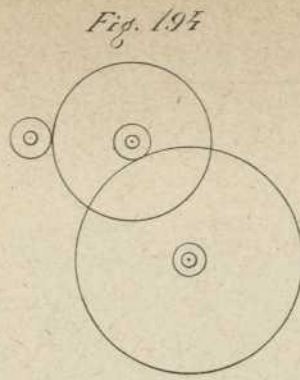
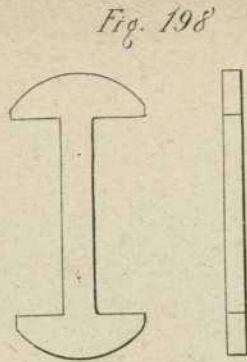
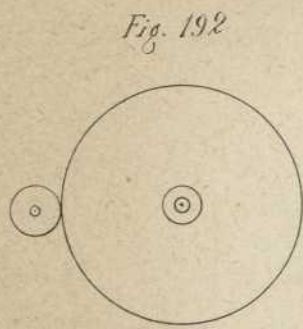


Fig. 200

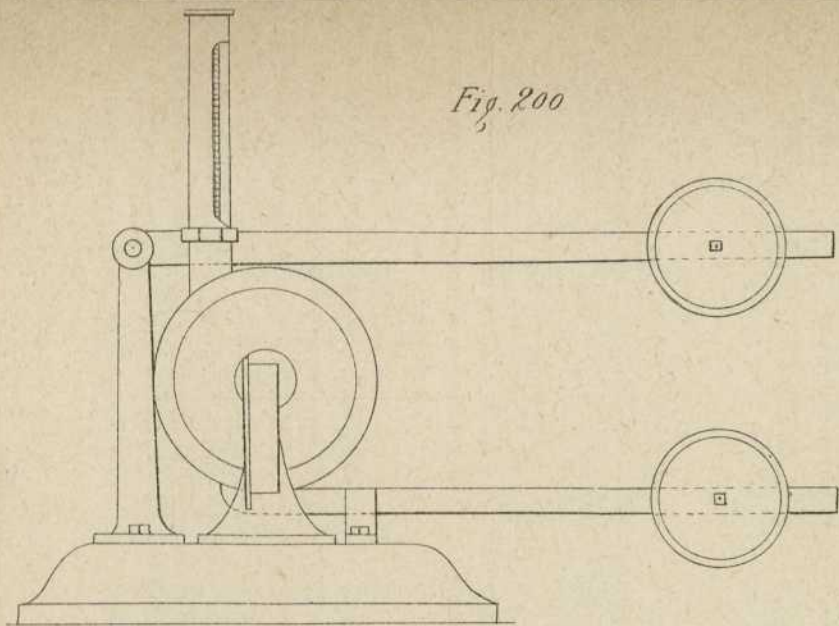


Fig. 201

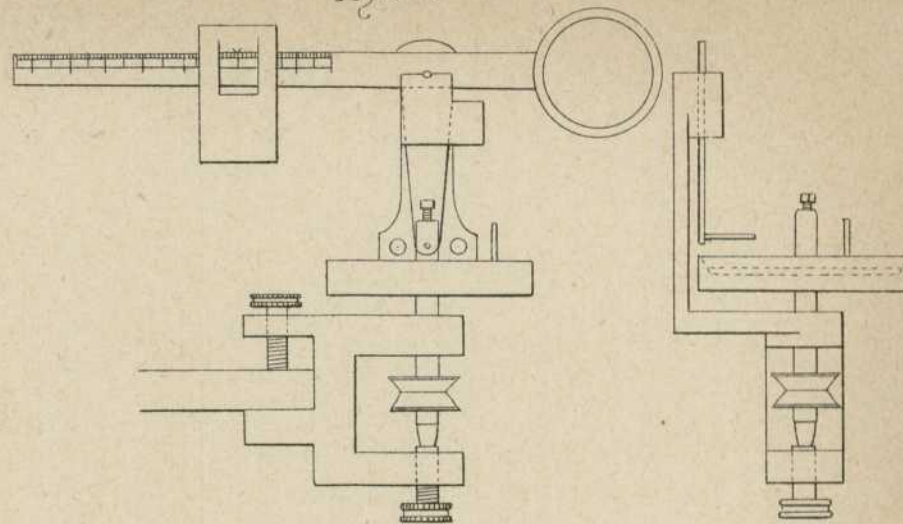


Fig. 202

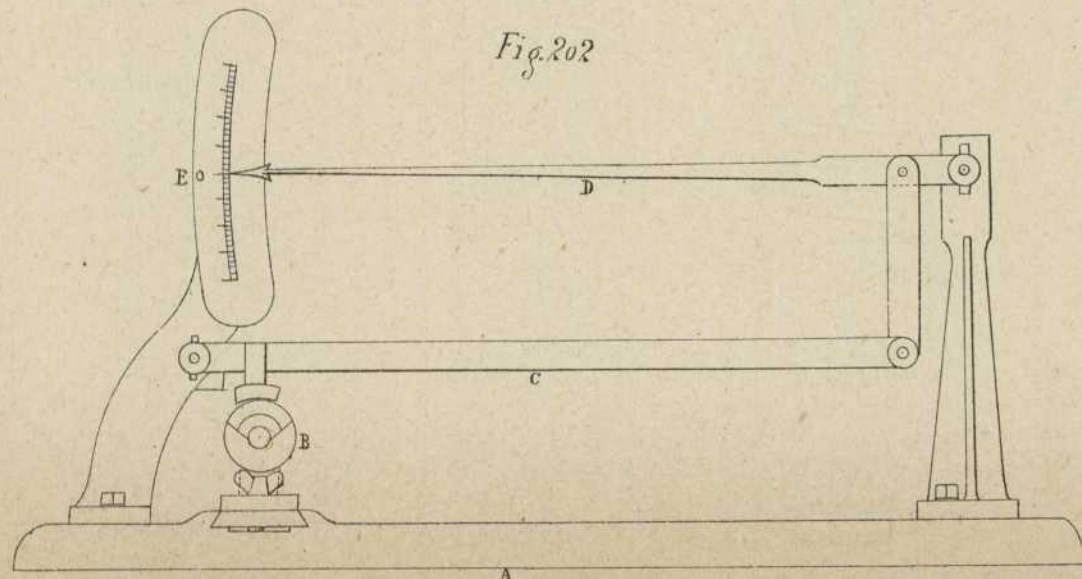
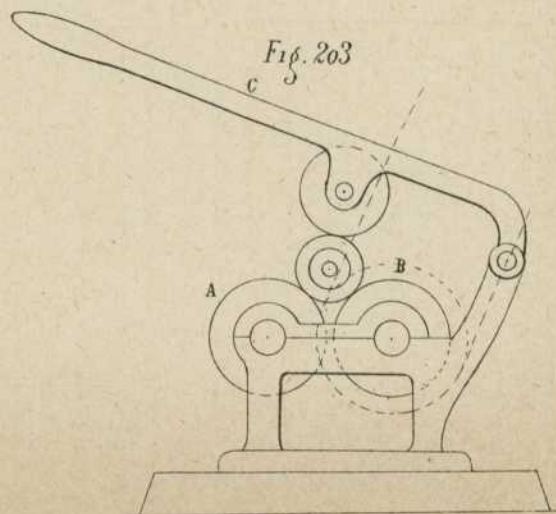


Fig. 203



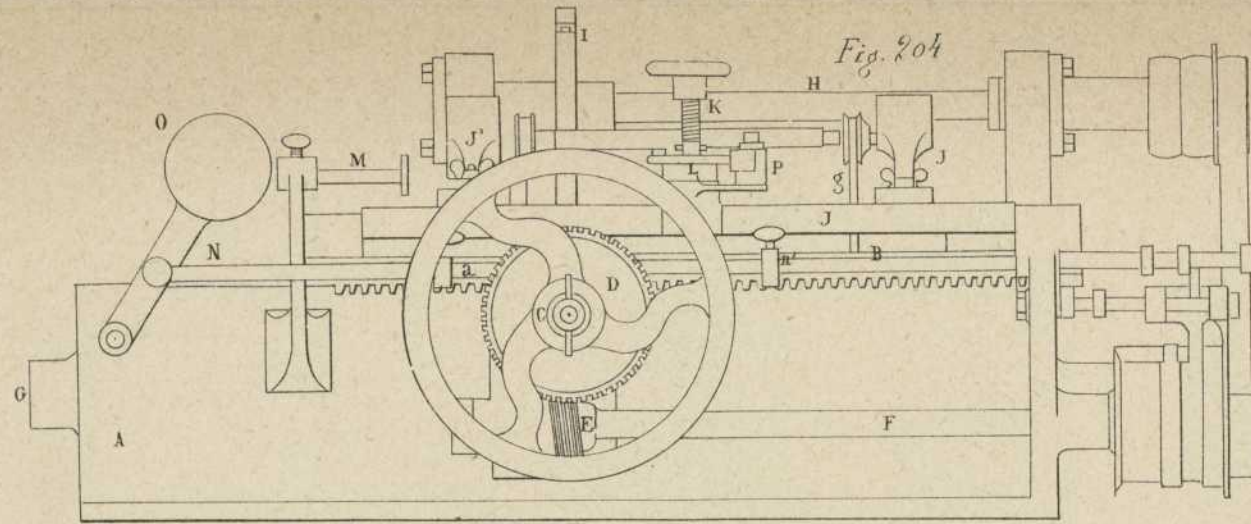


Fig. 204

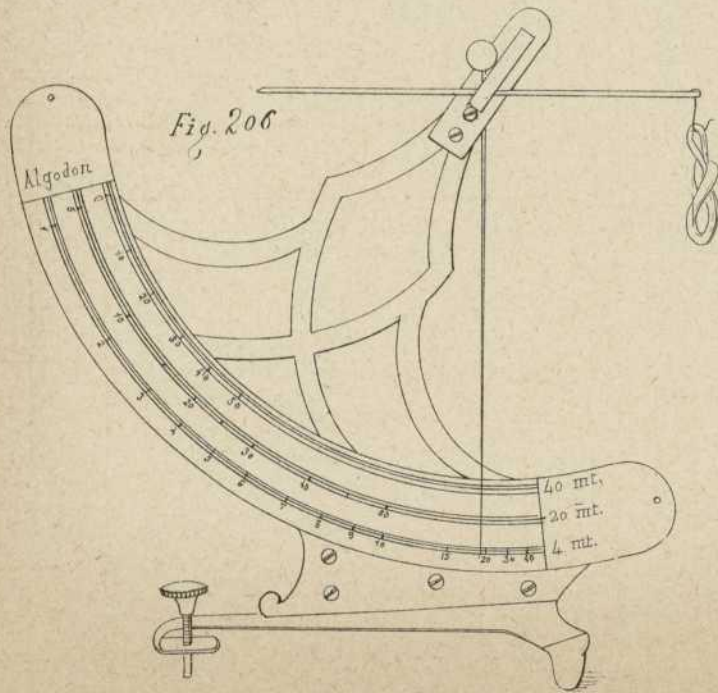


Fig. 206

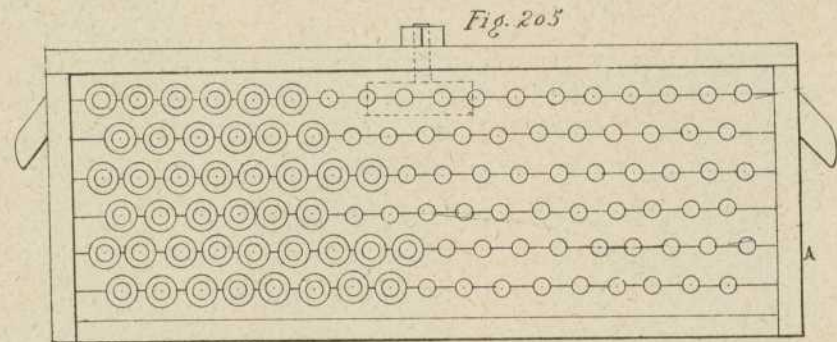
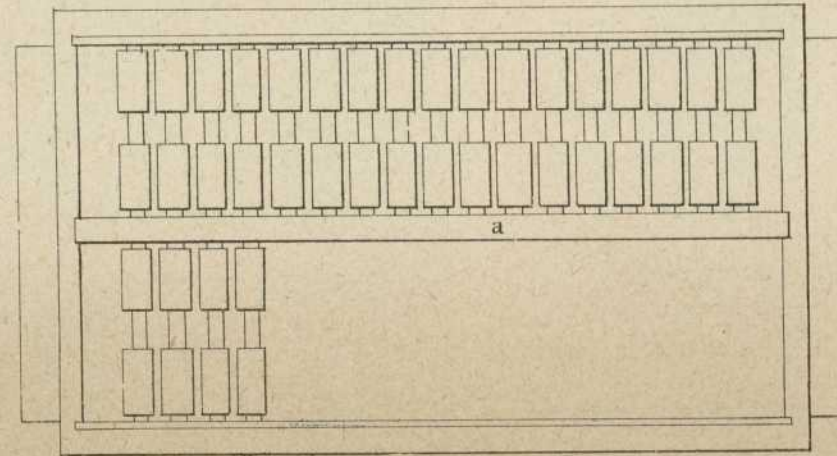


Fig. 205



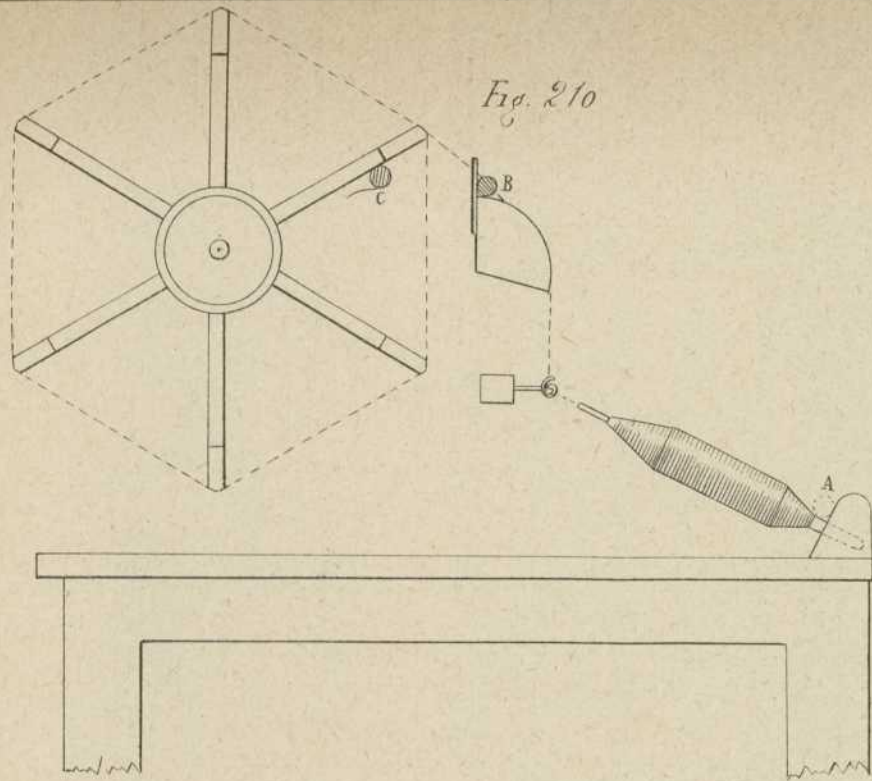


Fig. 210

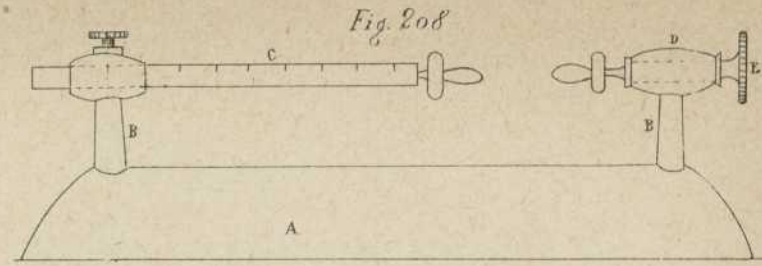


Fig. 208

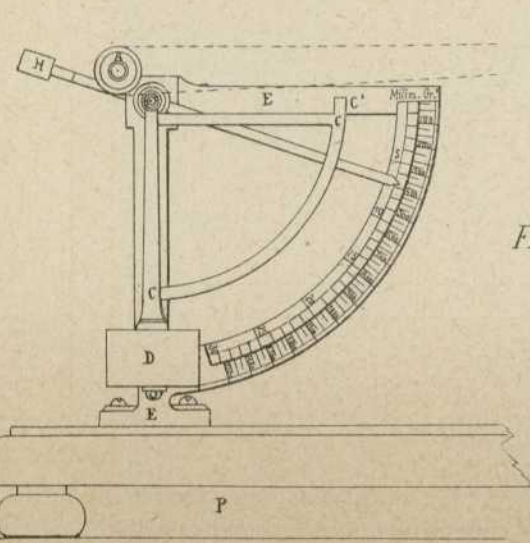


Fig. 209.

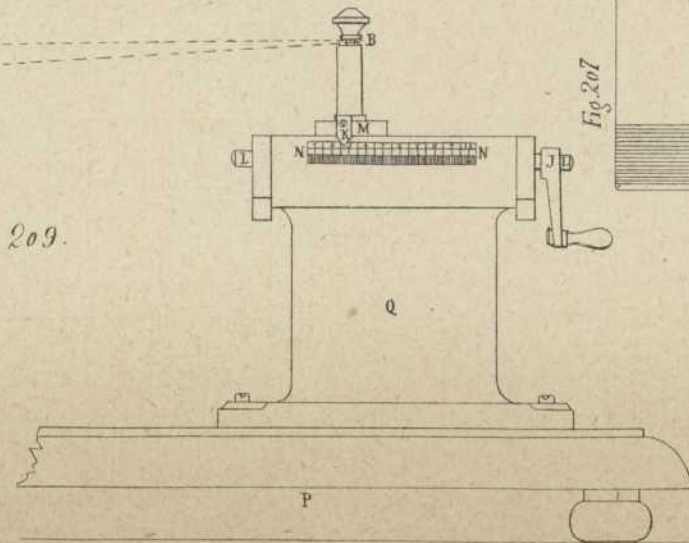
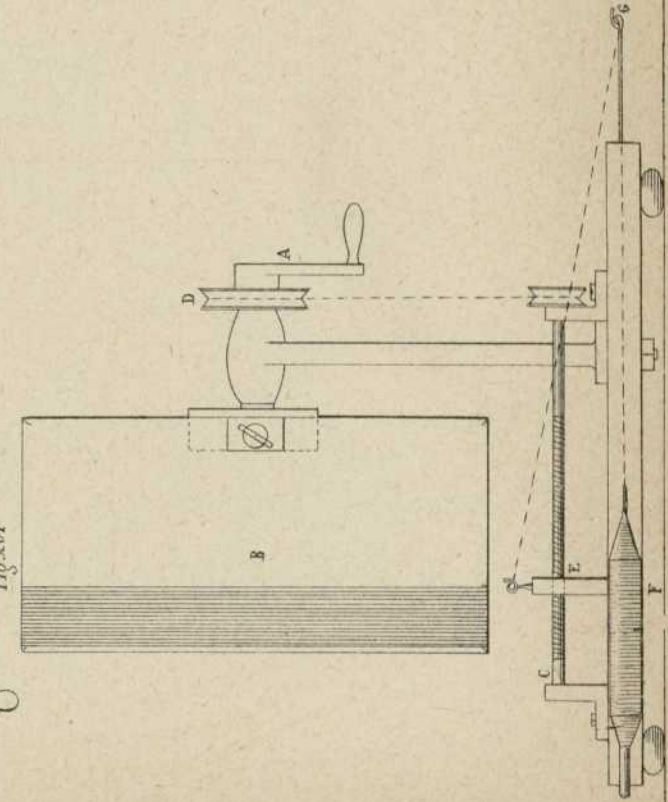
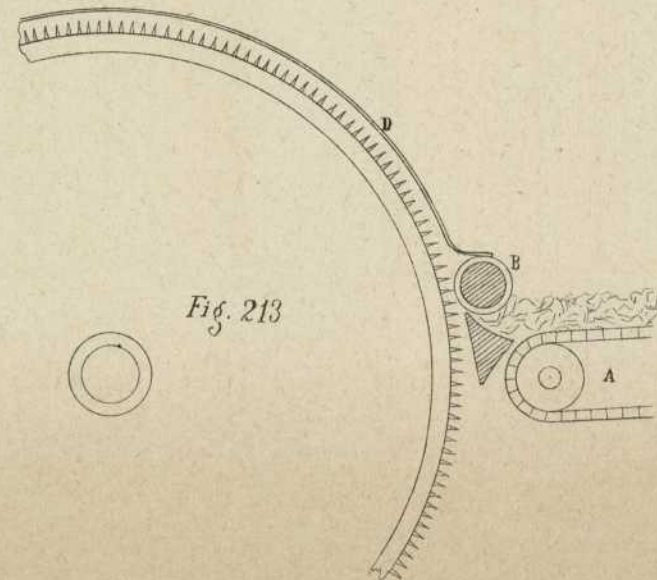
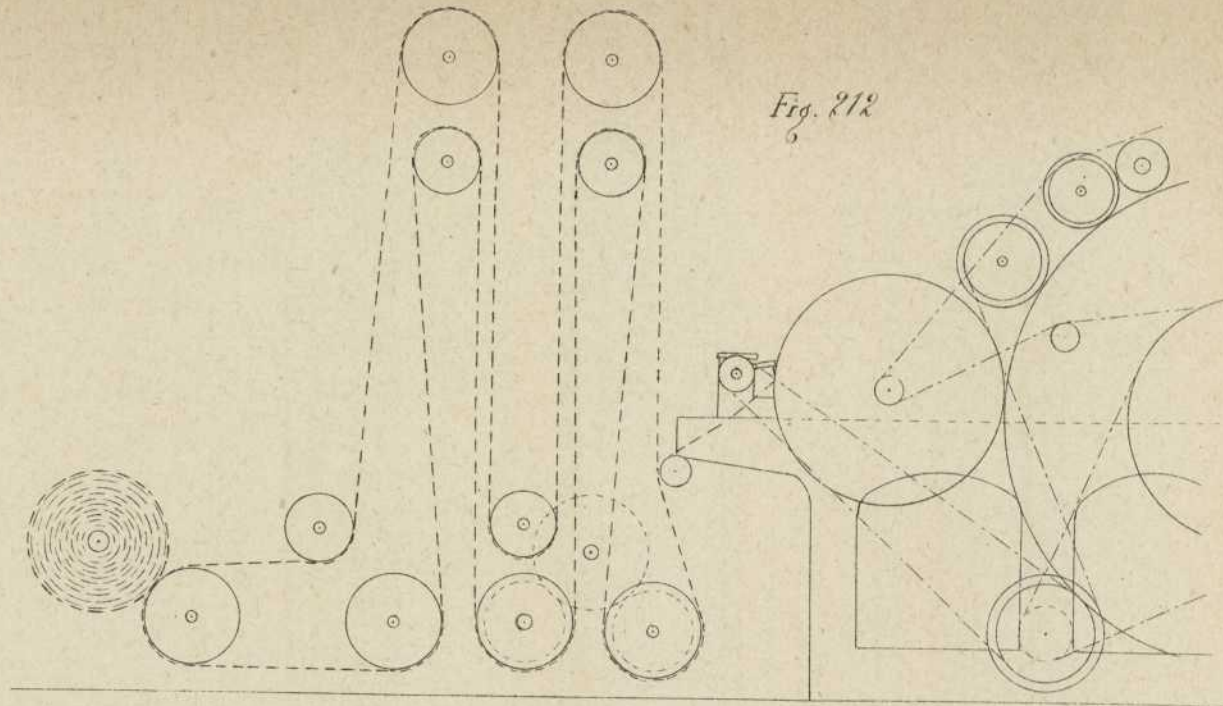
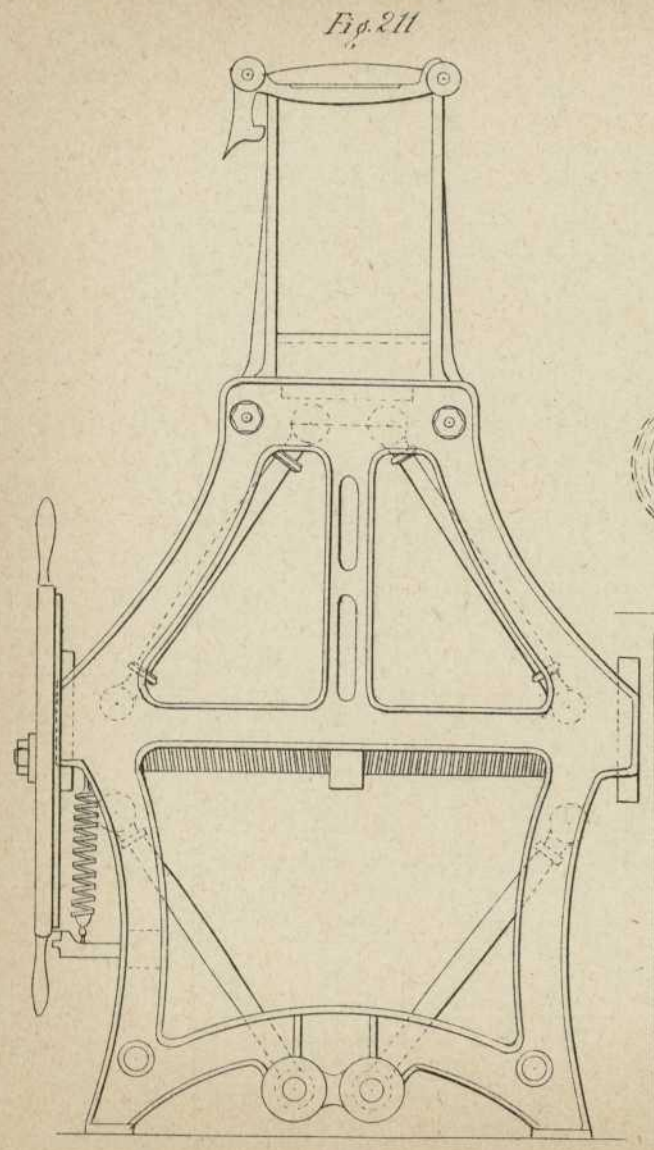
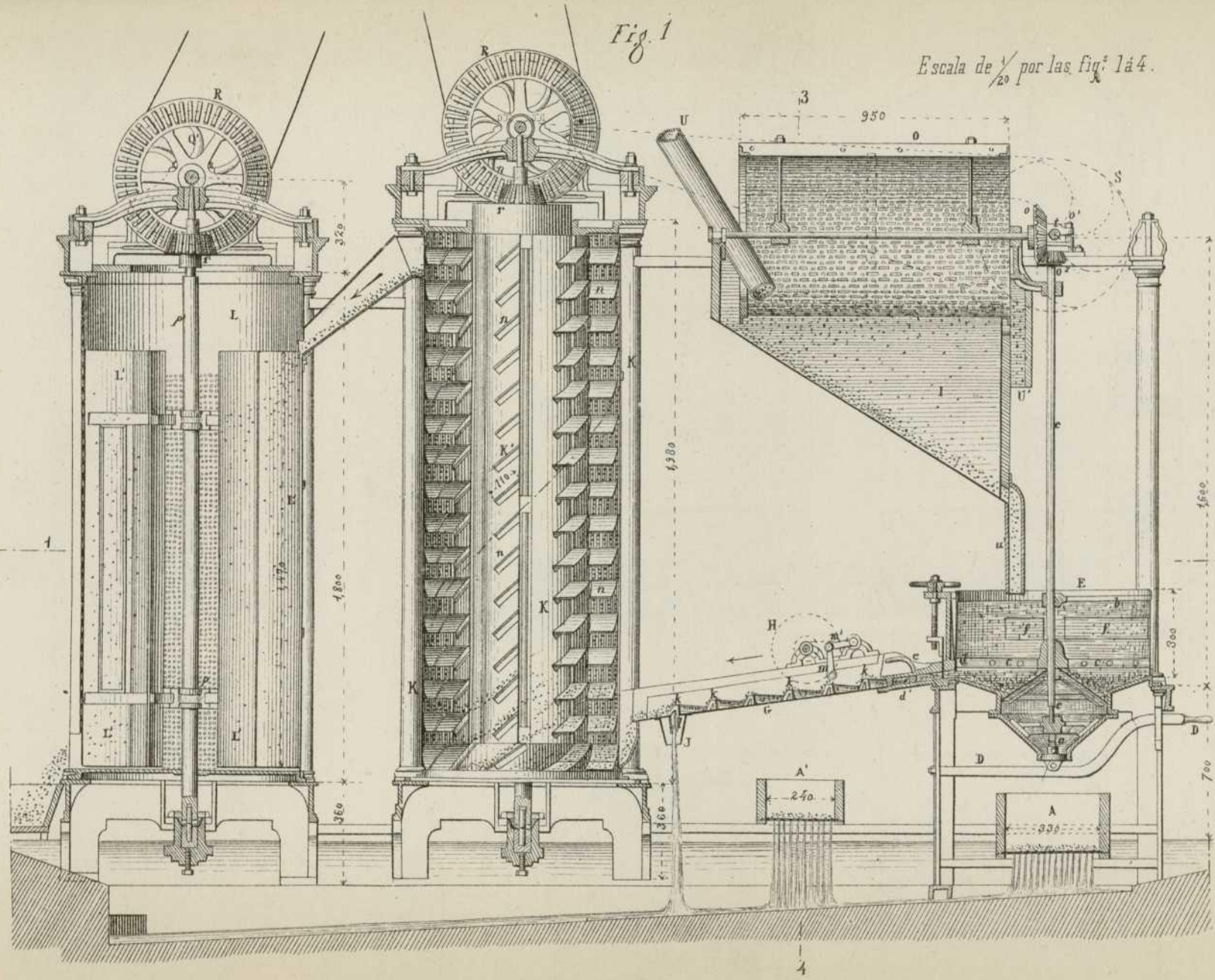


Fig. 207







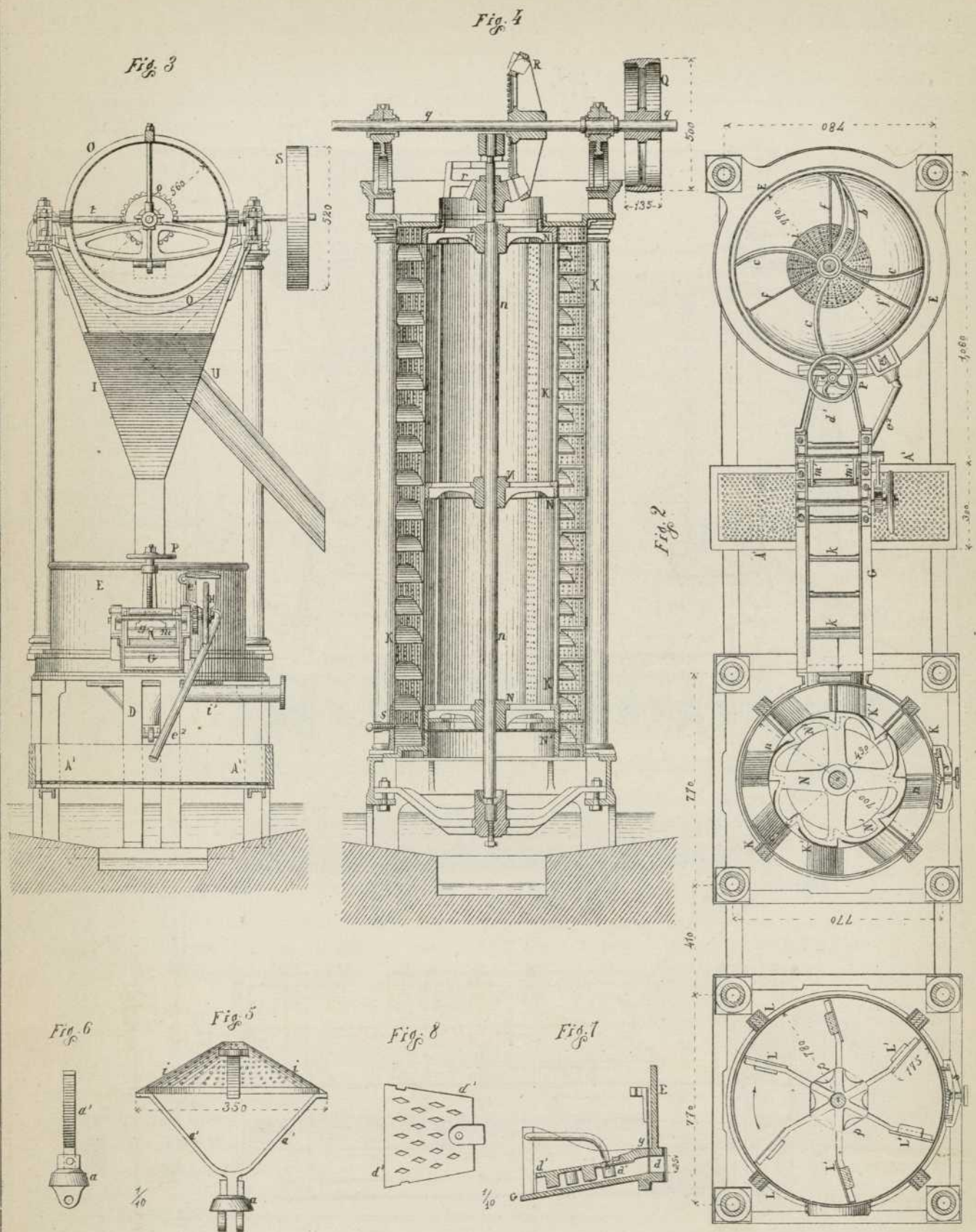


Fig. 1

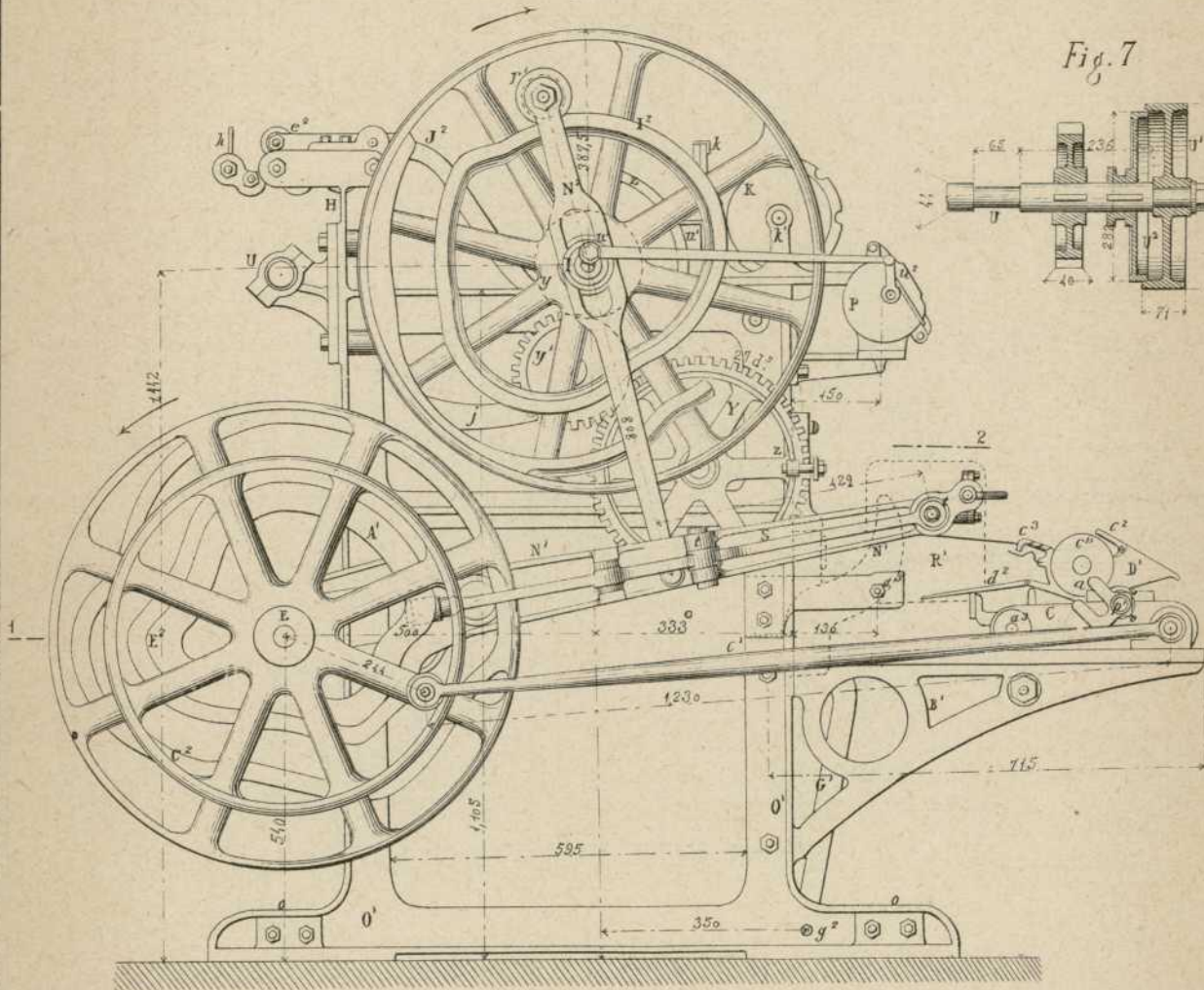


Fig. 7

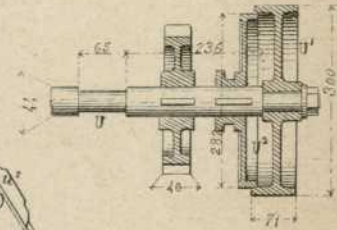
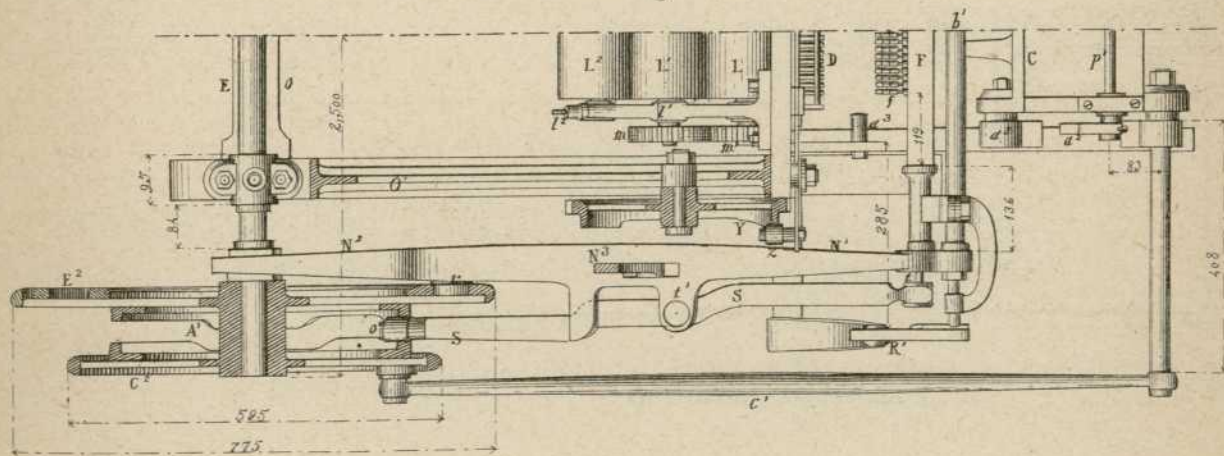


Fig. 2



Escala de $\frac{1}{12}$

Fig. 3

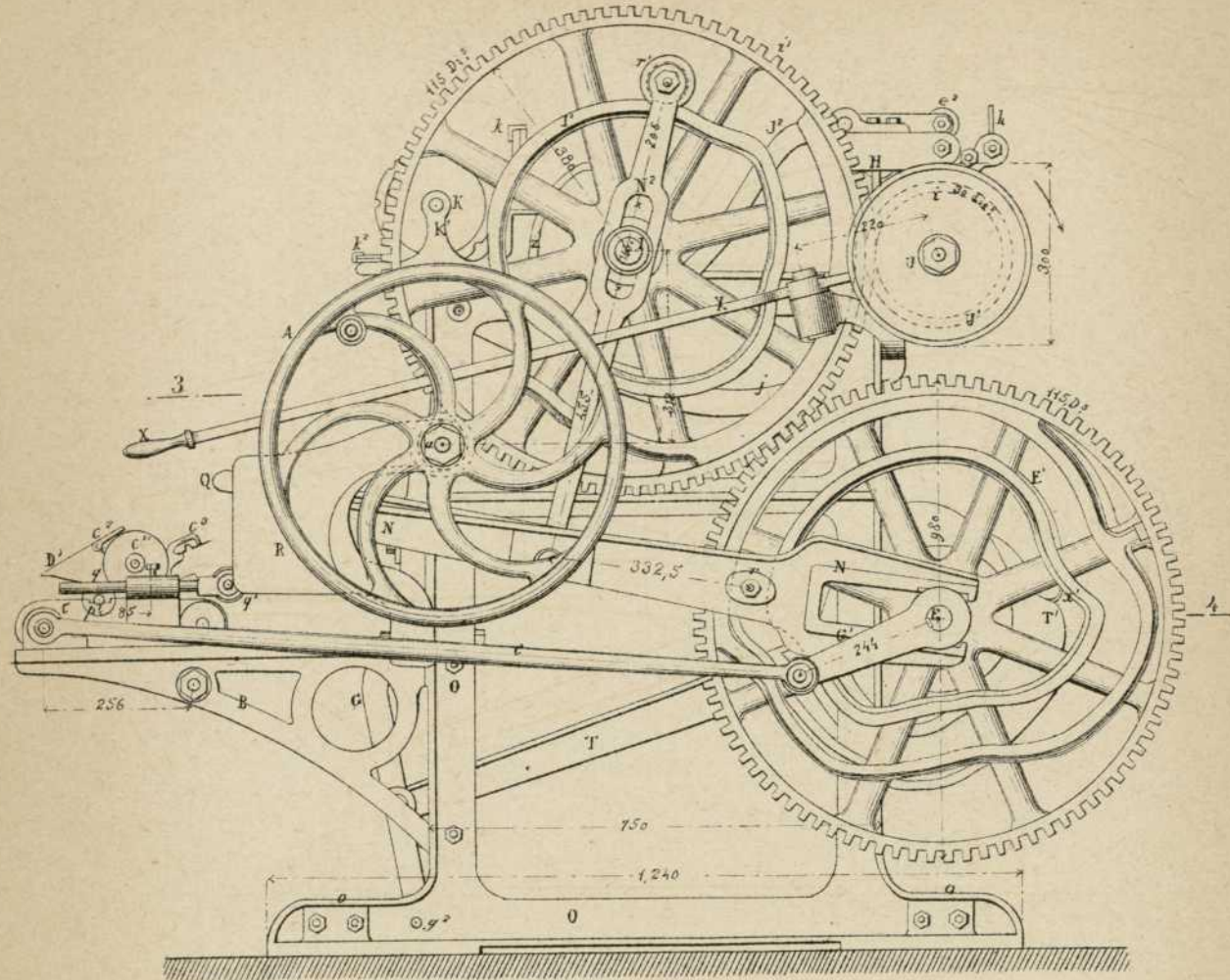
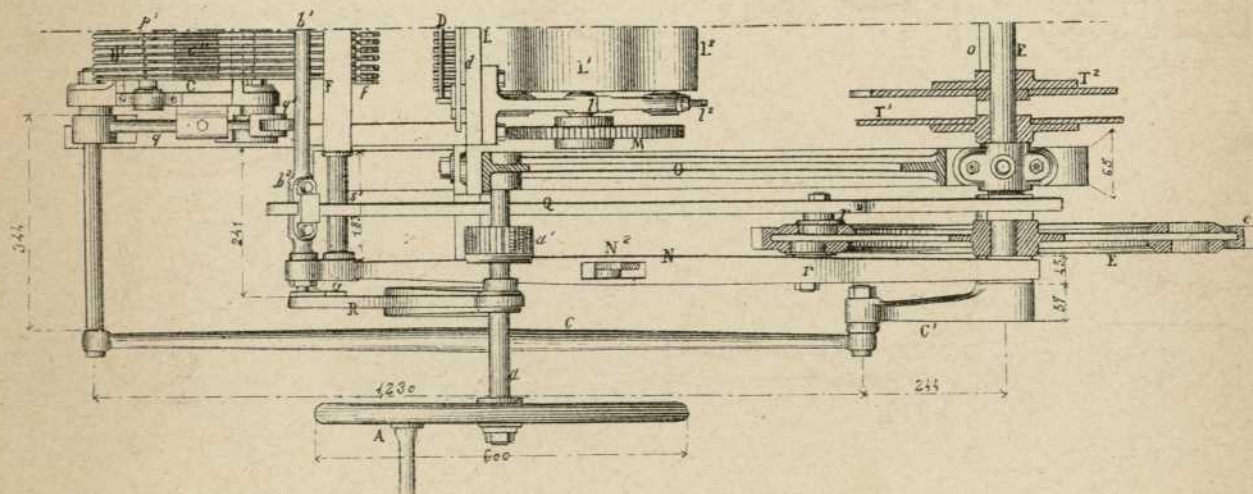


Fig. 4



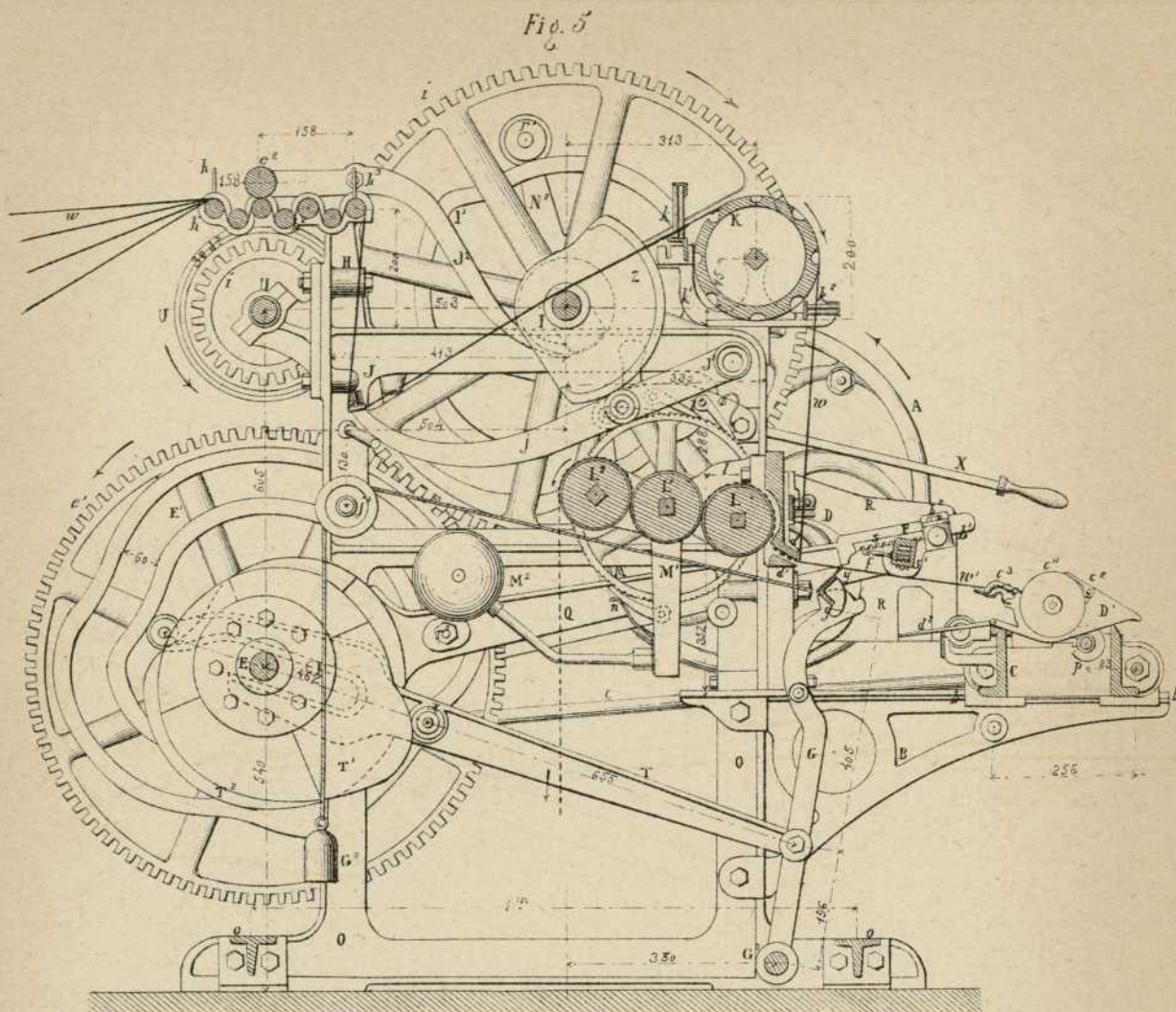


Fig. 5

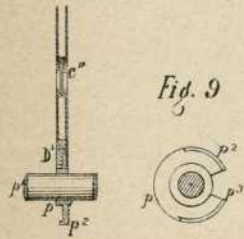


Fig. 9

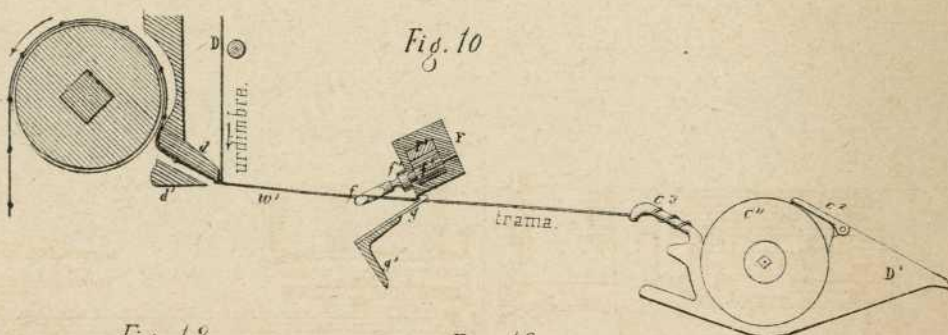


Fig. 10

Fig. 11

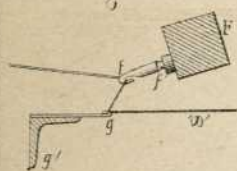


Fig. 12

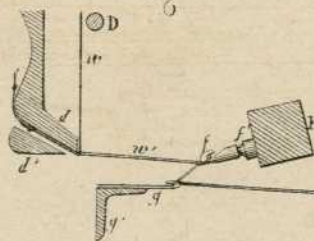


Fig. 13

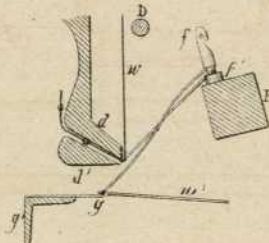
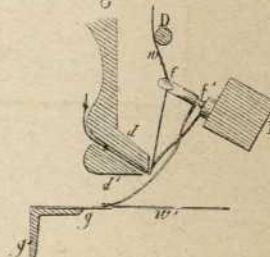
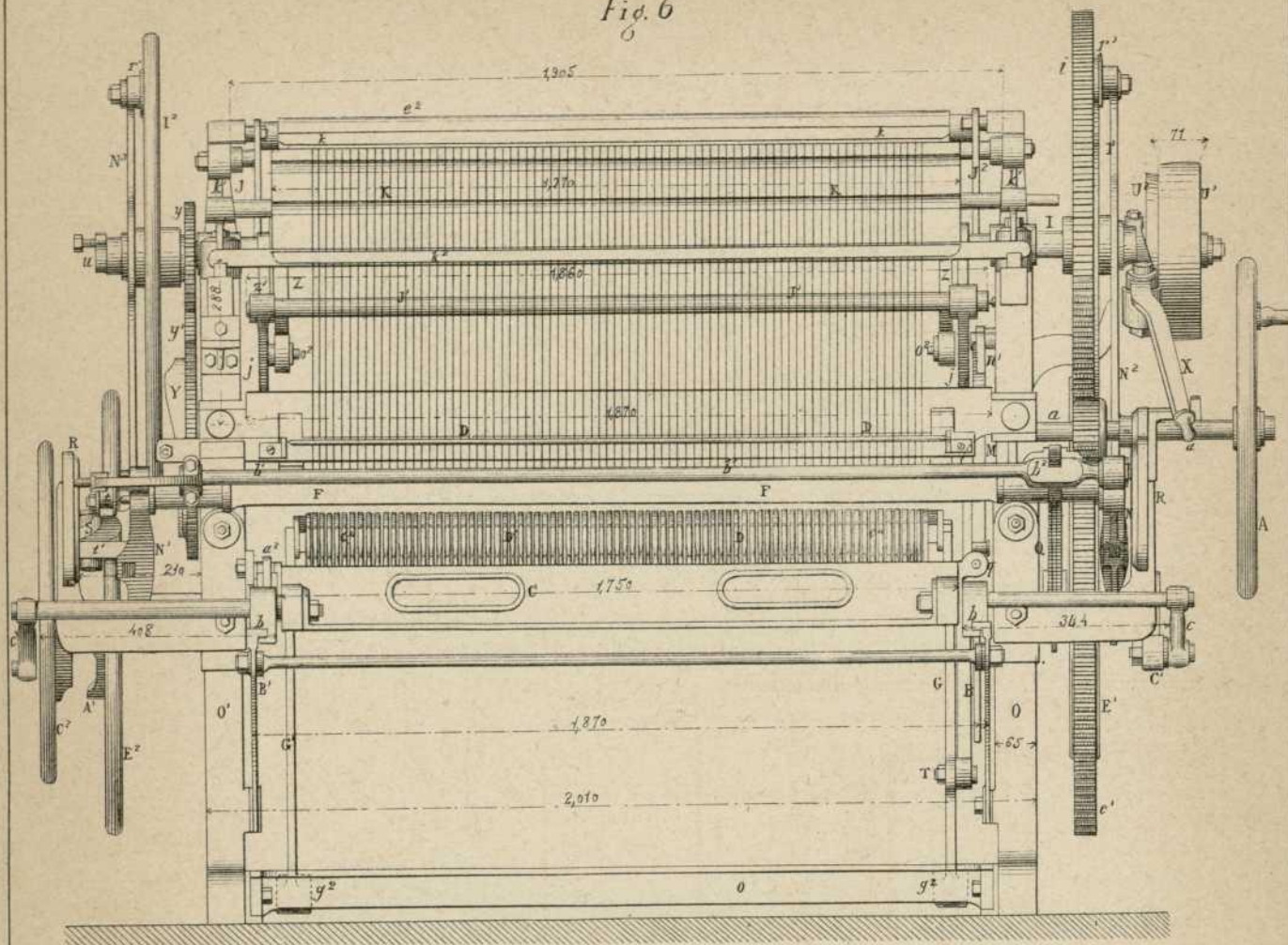


Fig. 14



Escala de 1/2 por las Fig 5 y 6

Fig. 6



Escala de 1/6 por las Fig 8 á 20

Fig. 15

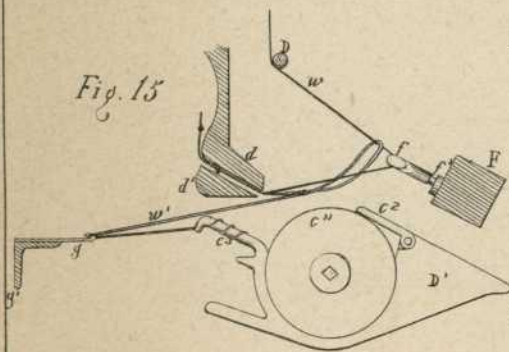


Fig. 16

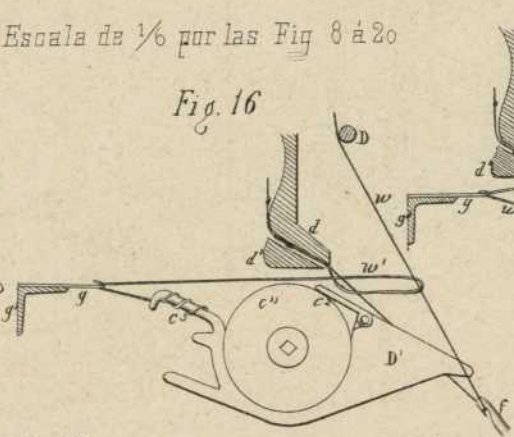


Fig. 17

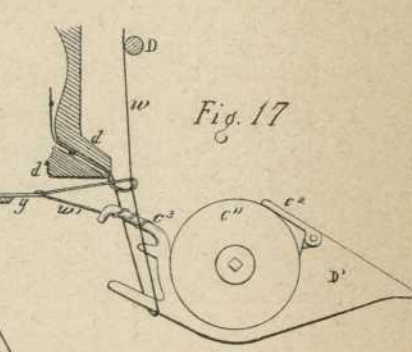


Fig. 18

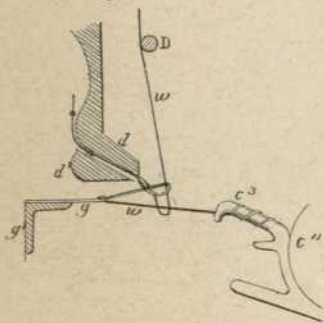


Fig. 19

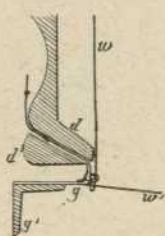


Fig. 20

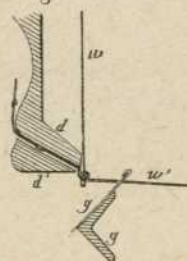


Fig. 21



Fig. 22



Fig. 1

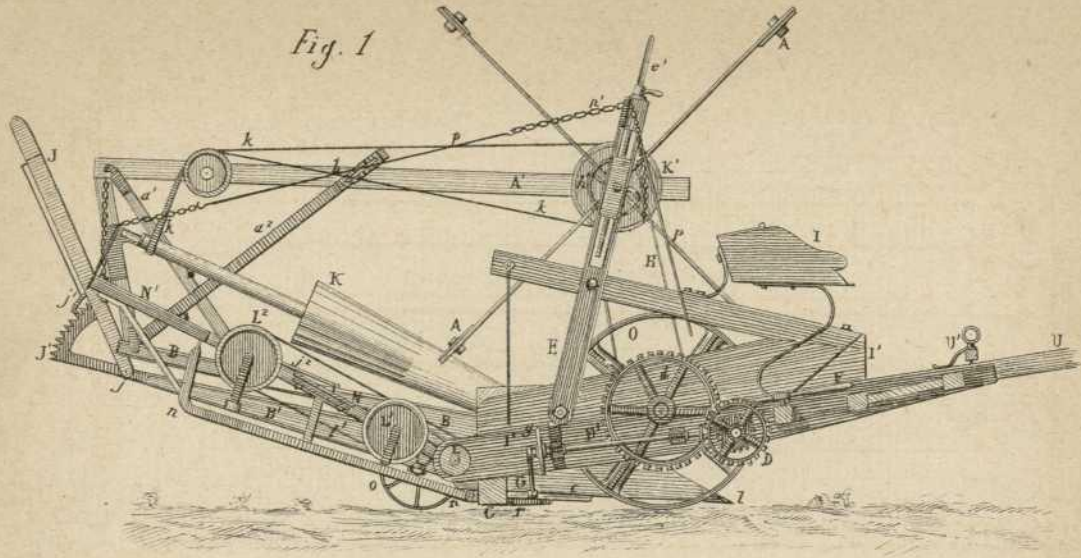


Fig. 2

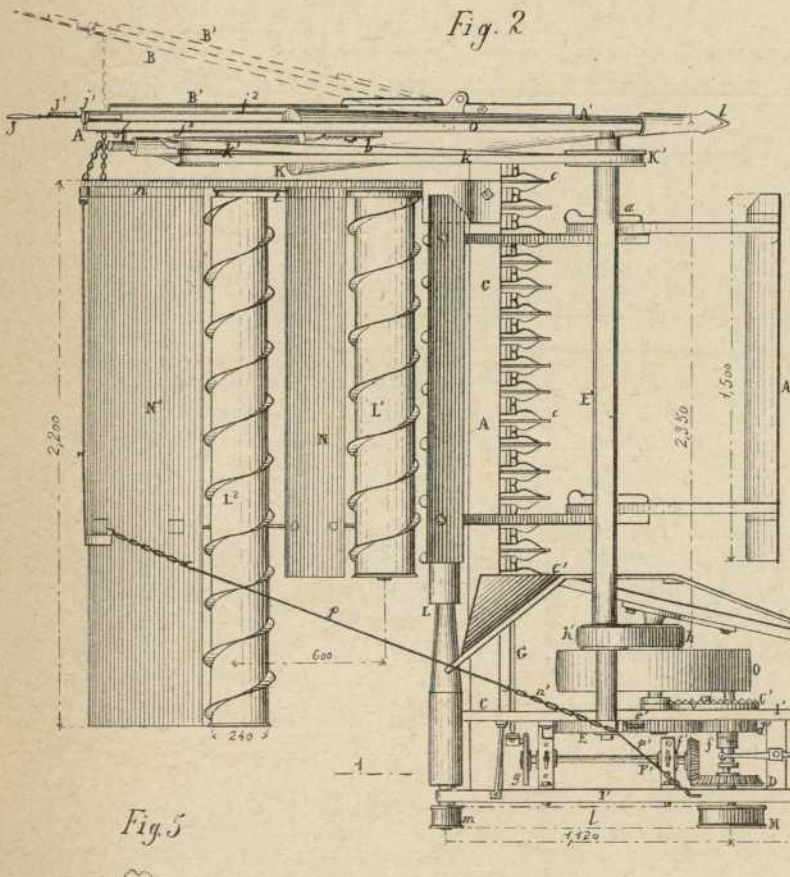


Fig. 10

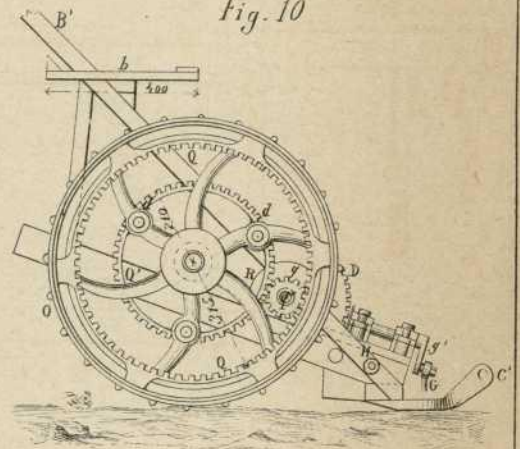


Fig. 5

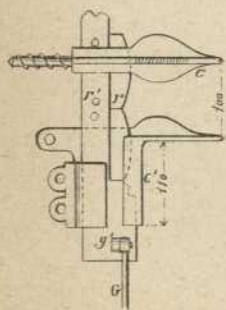


Fig. 3

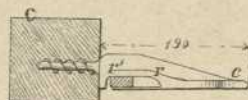


Fig. 4

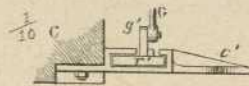
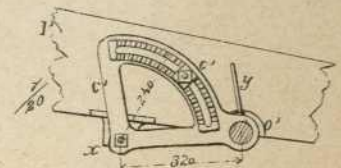


Fig. 6



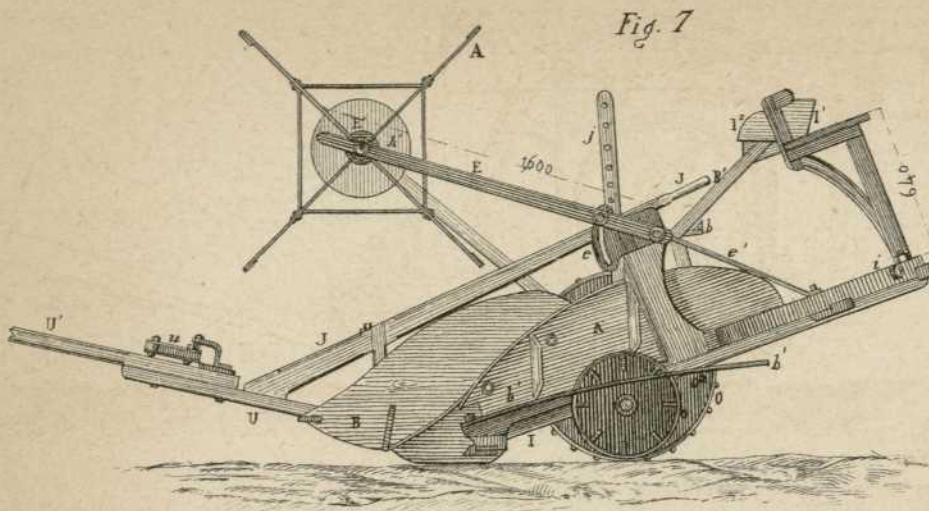


Fig. 7

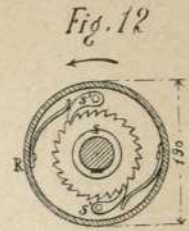


Fig. 12

1/10

Fig. 13

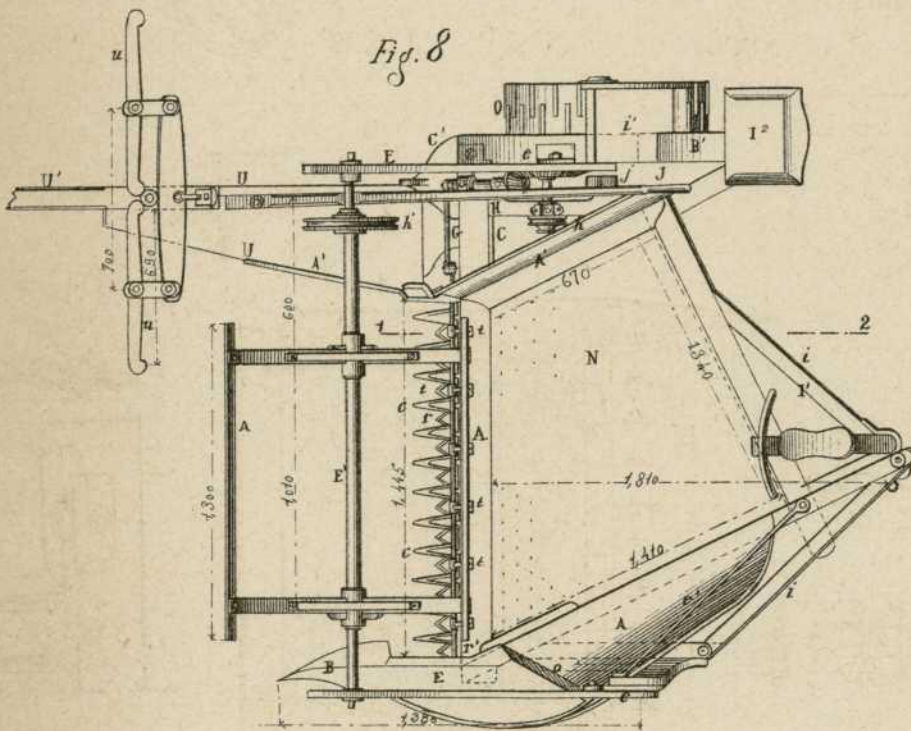
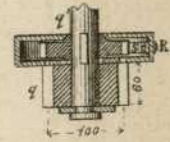


Fig. 8

Fig. 14

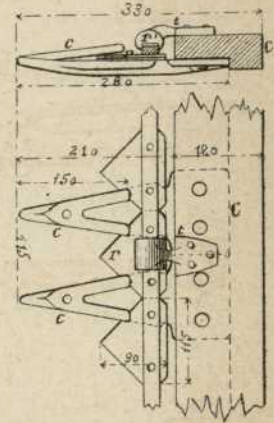


Fig. 11
Escala de 1/20

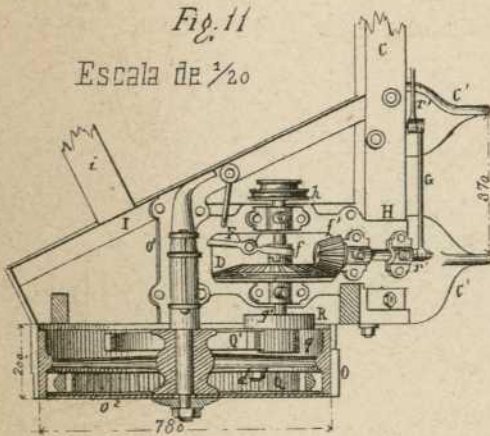
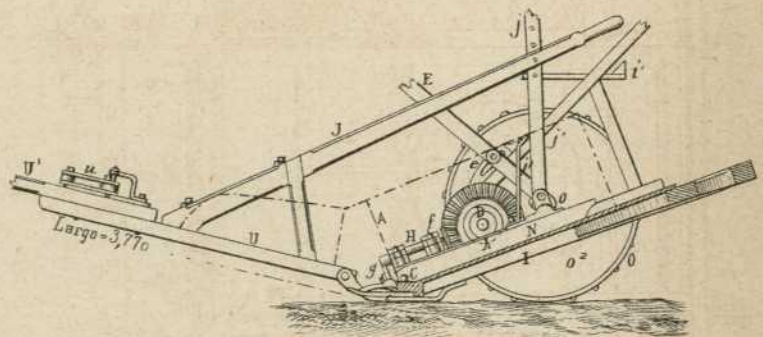


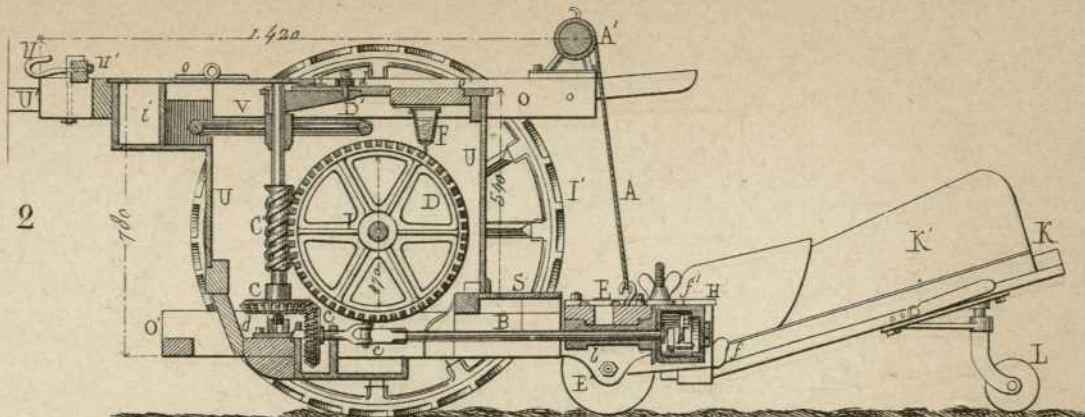
Fig. 9



Escala de 1/30 por las Fig. 1, 2, y 7 a 9

A.O

Fig. 2



Escala de 1/20 por las Fig. de 1 á 10.

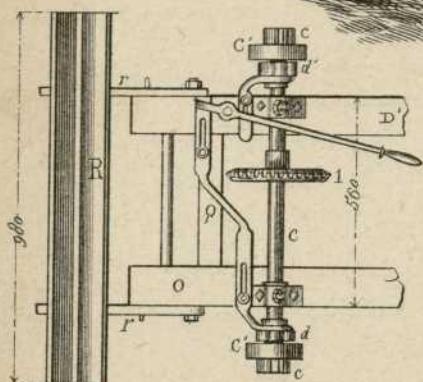


Fig. 5.

Fig. 8.

Fig. 12.



Fig. 11.

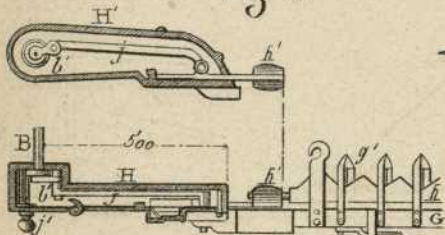


Fig. 4.

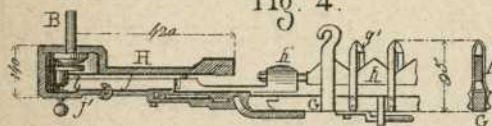


Fig. 1.

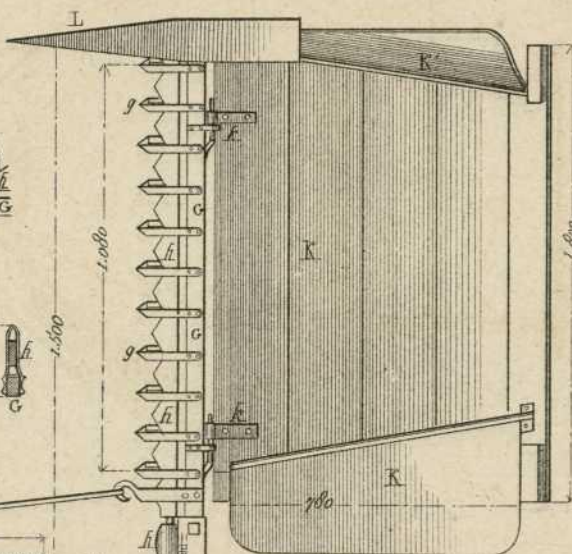


Fig. 9.

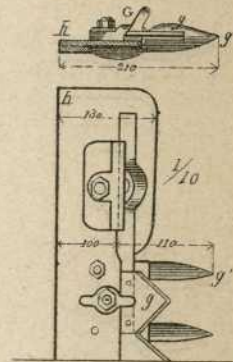


Fig. 10.

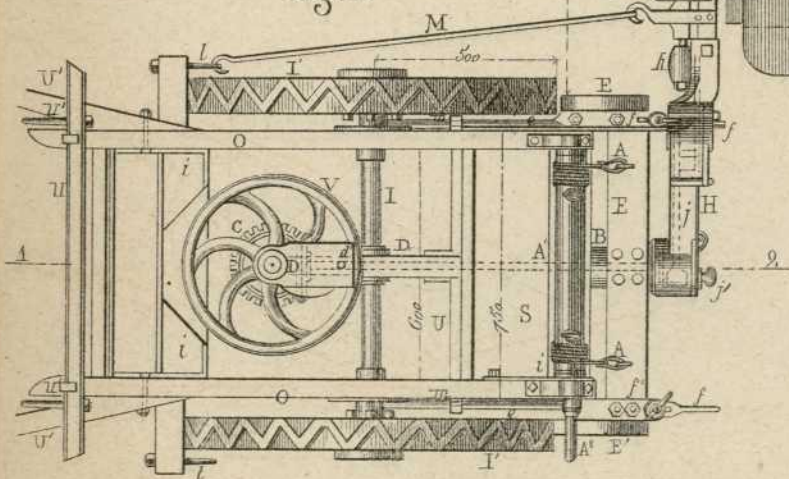
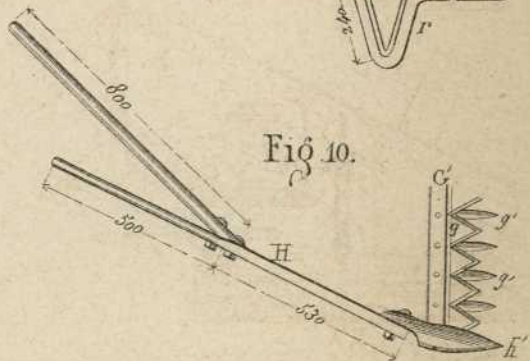


Fig. 6.

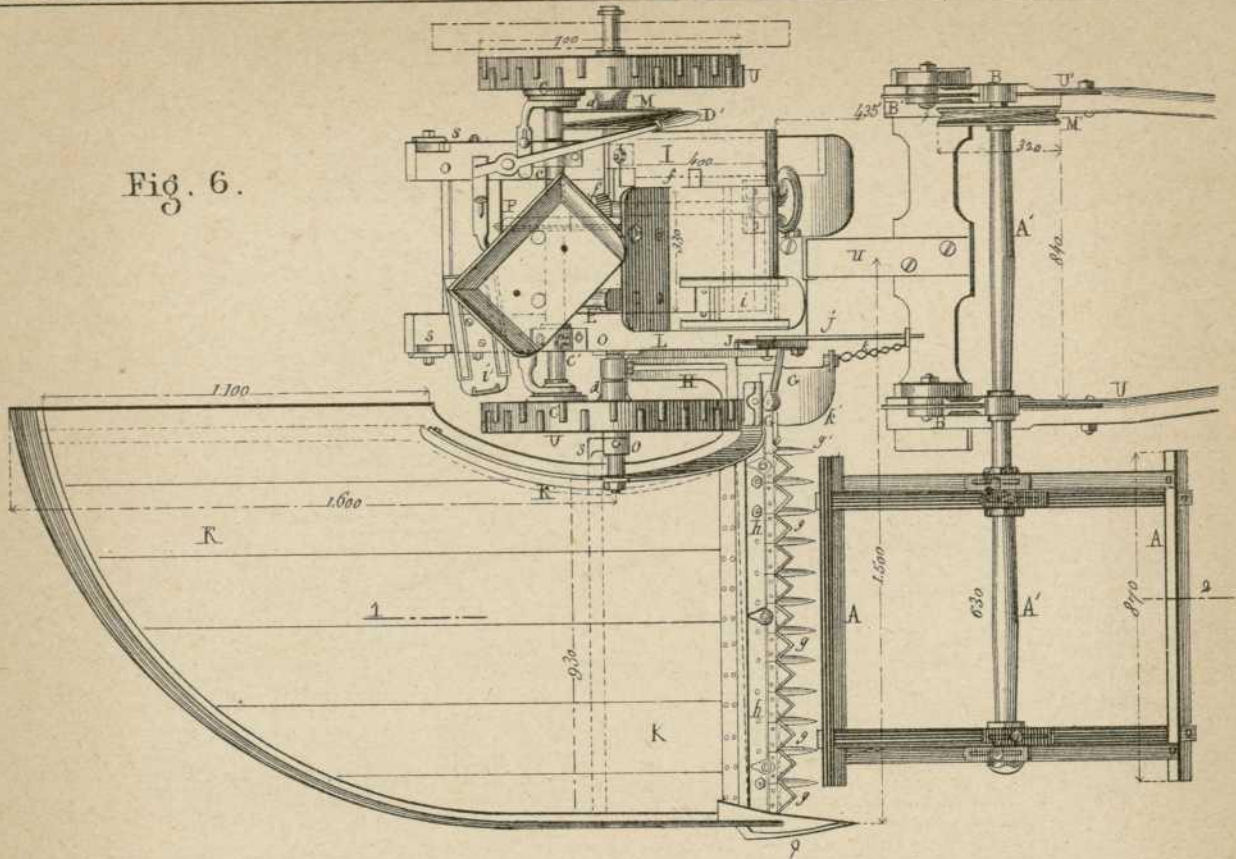


Fig. 7.

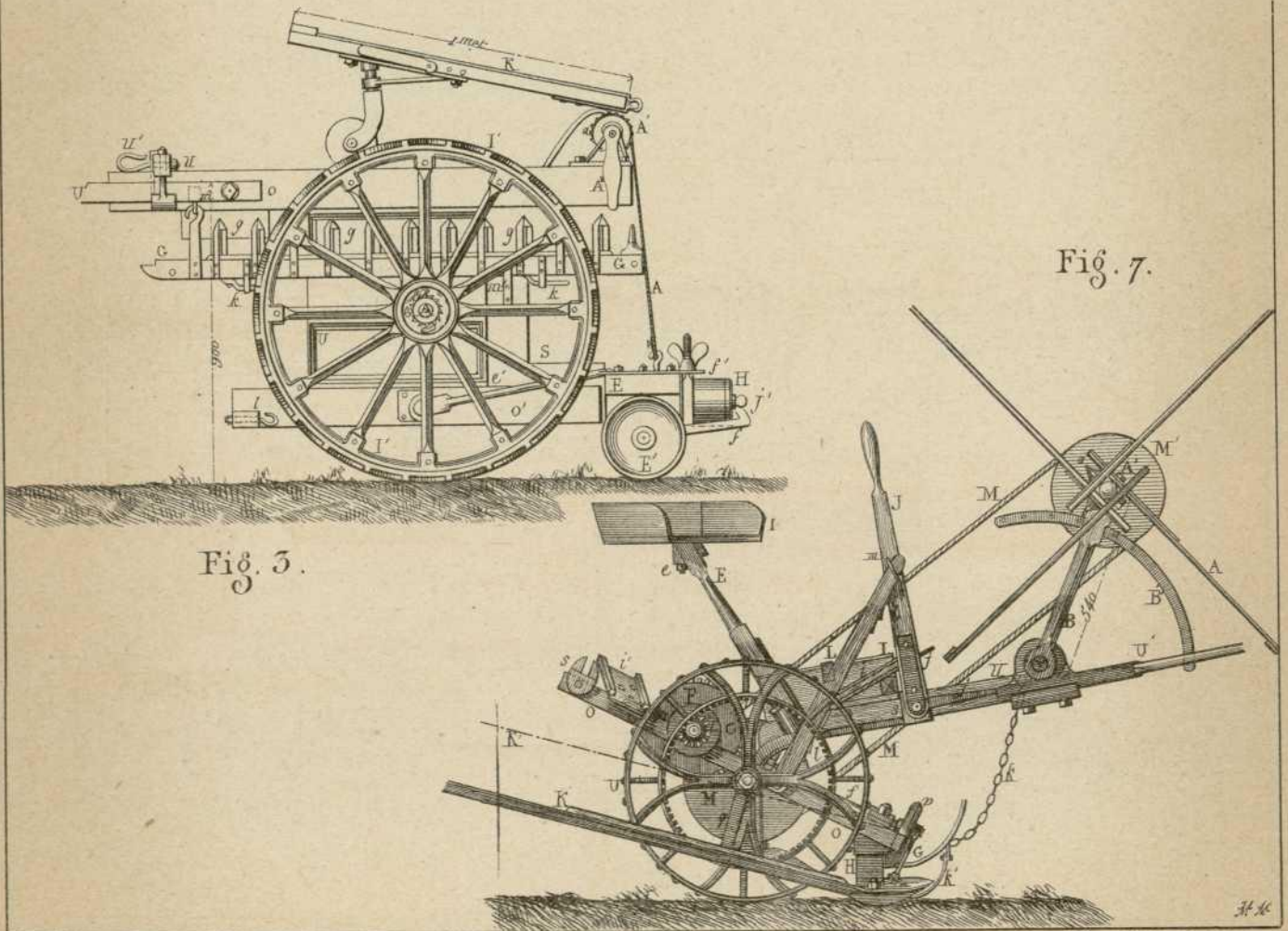


Fig. 3.

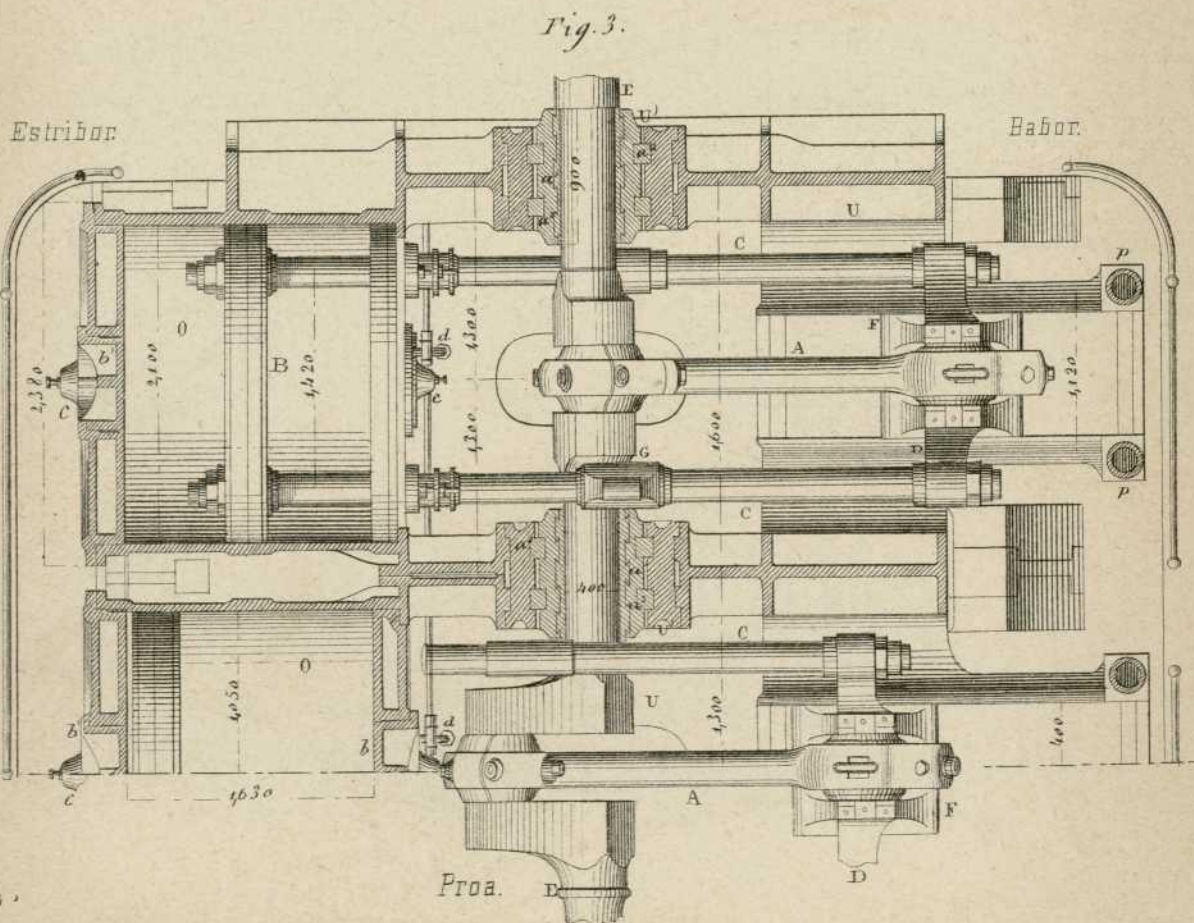
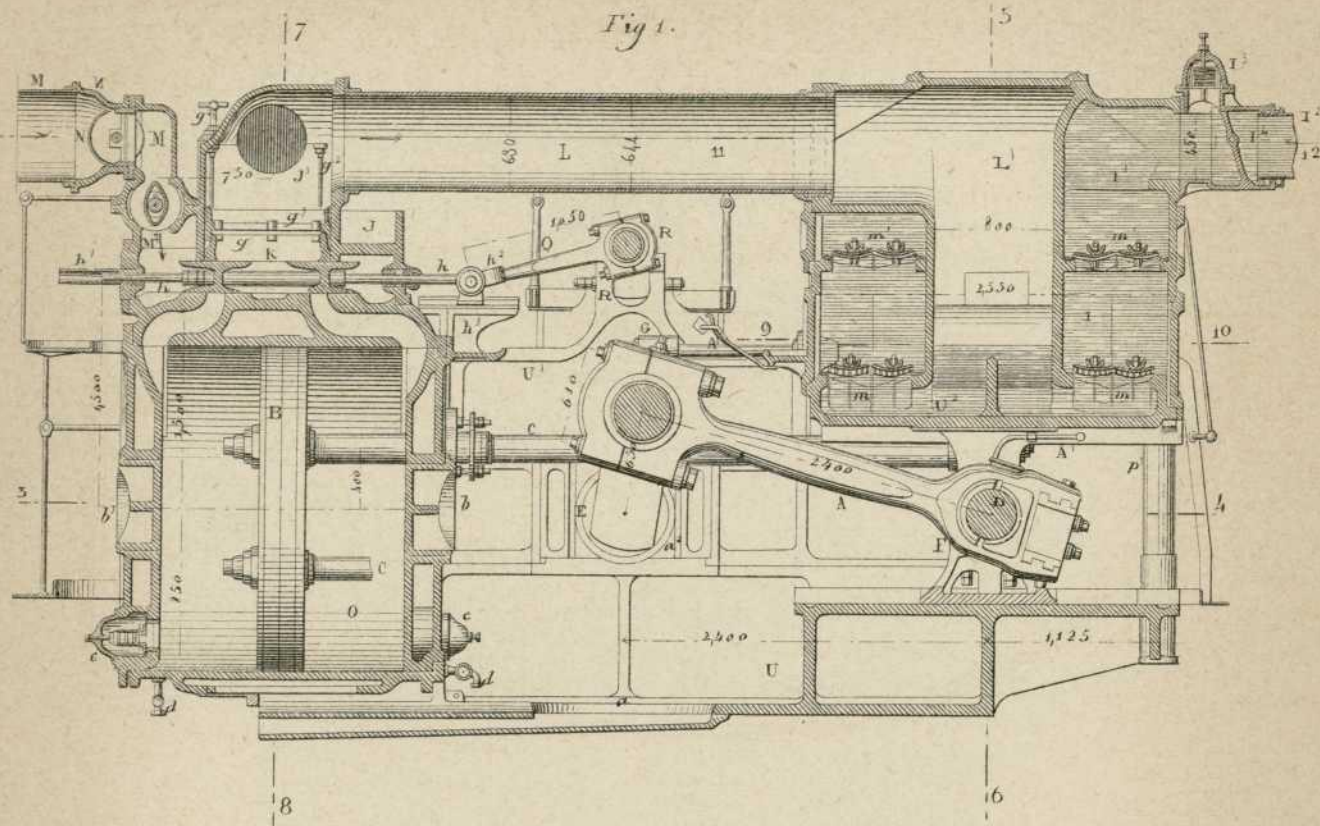


Fig. 2.

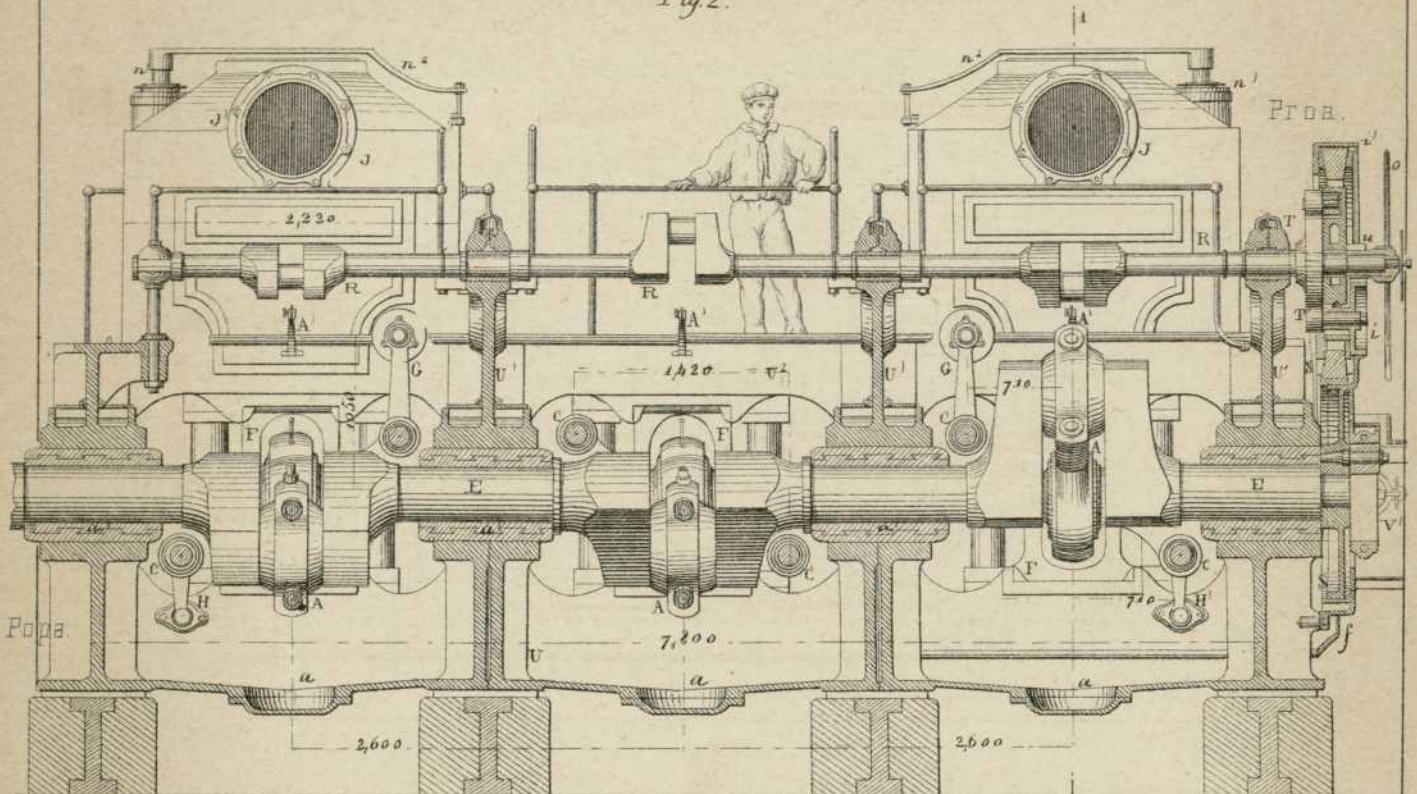
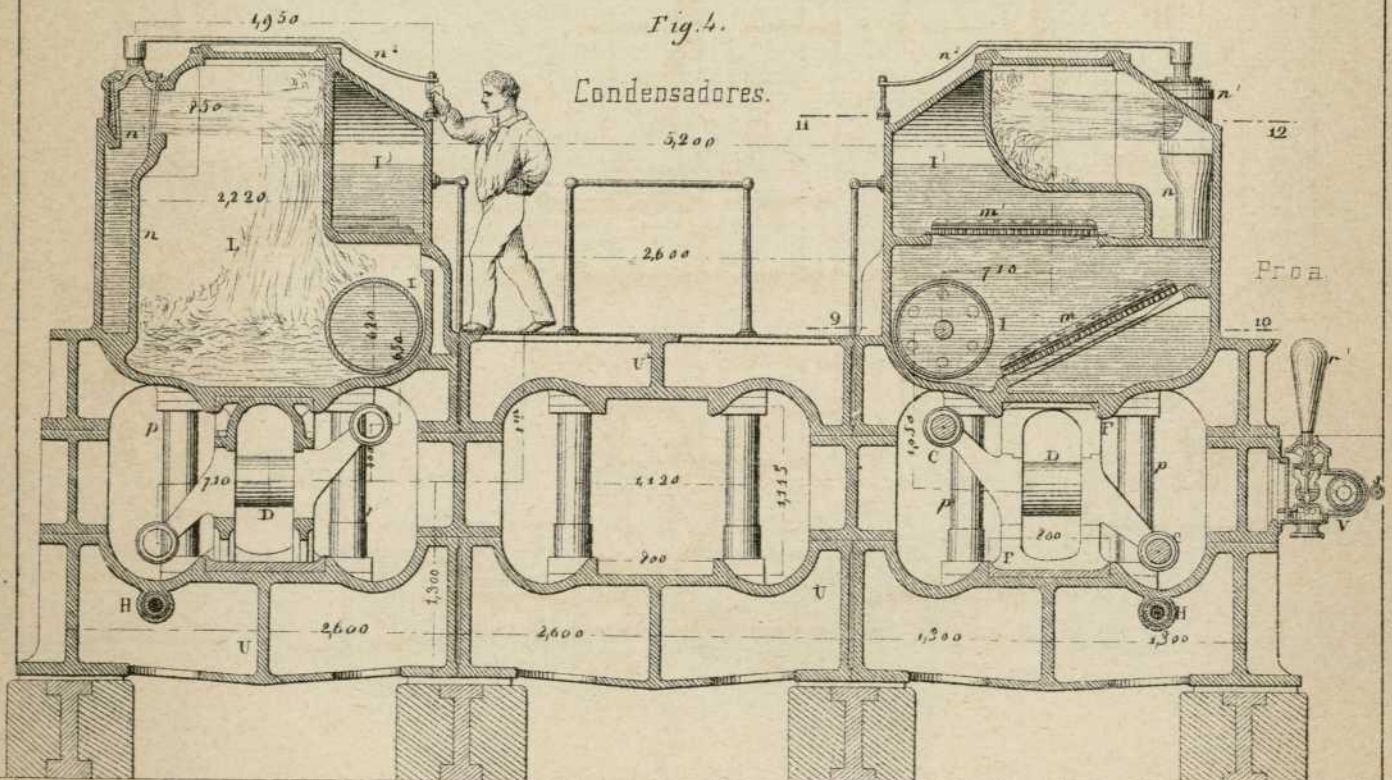


Fig. 4.

Condensadores.



Escala de 1/50

Fig. 5.

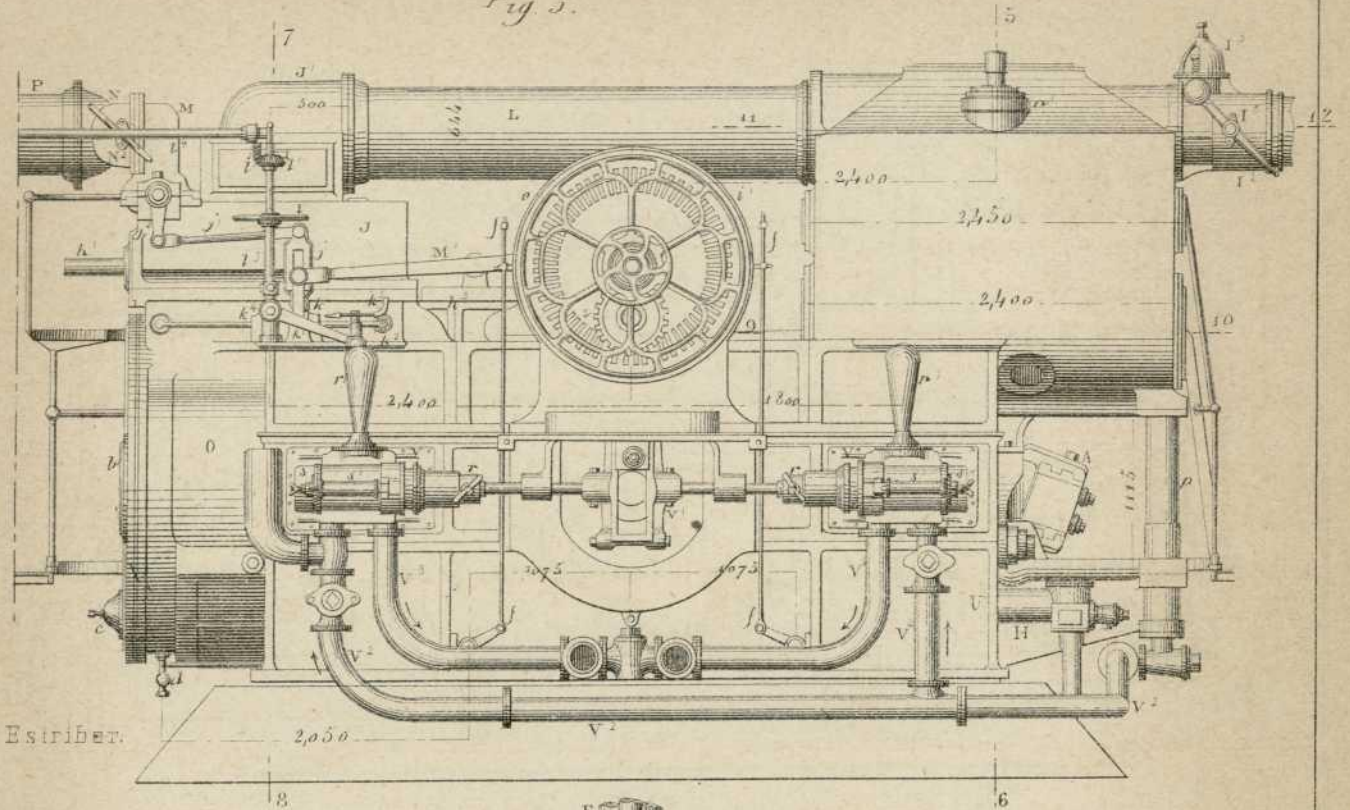
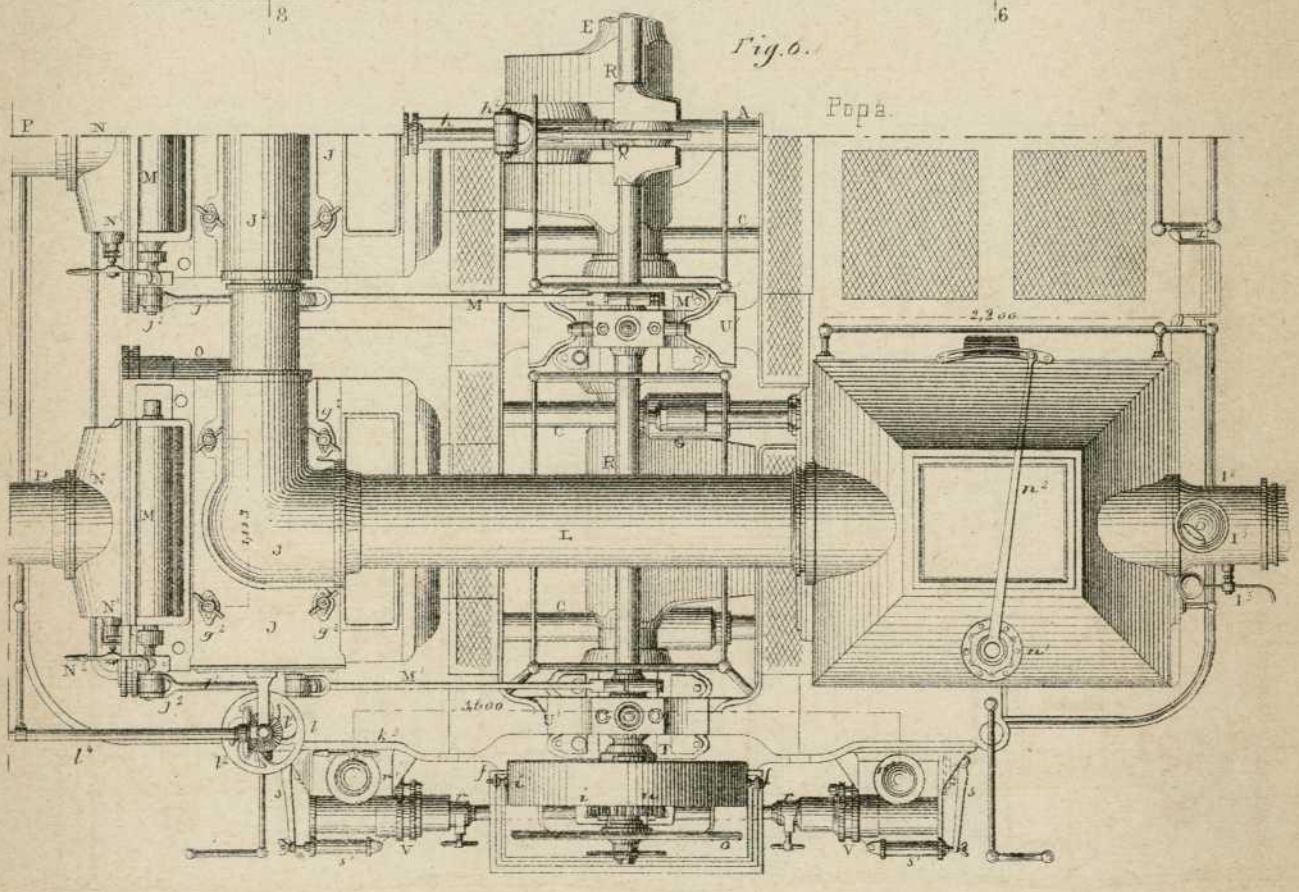
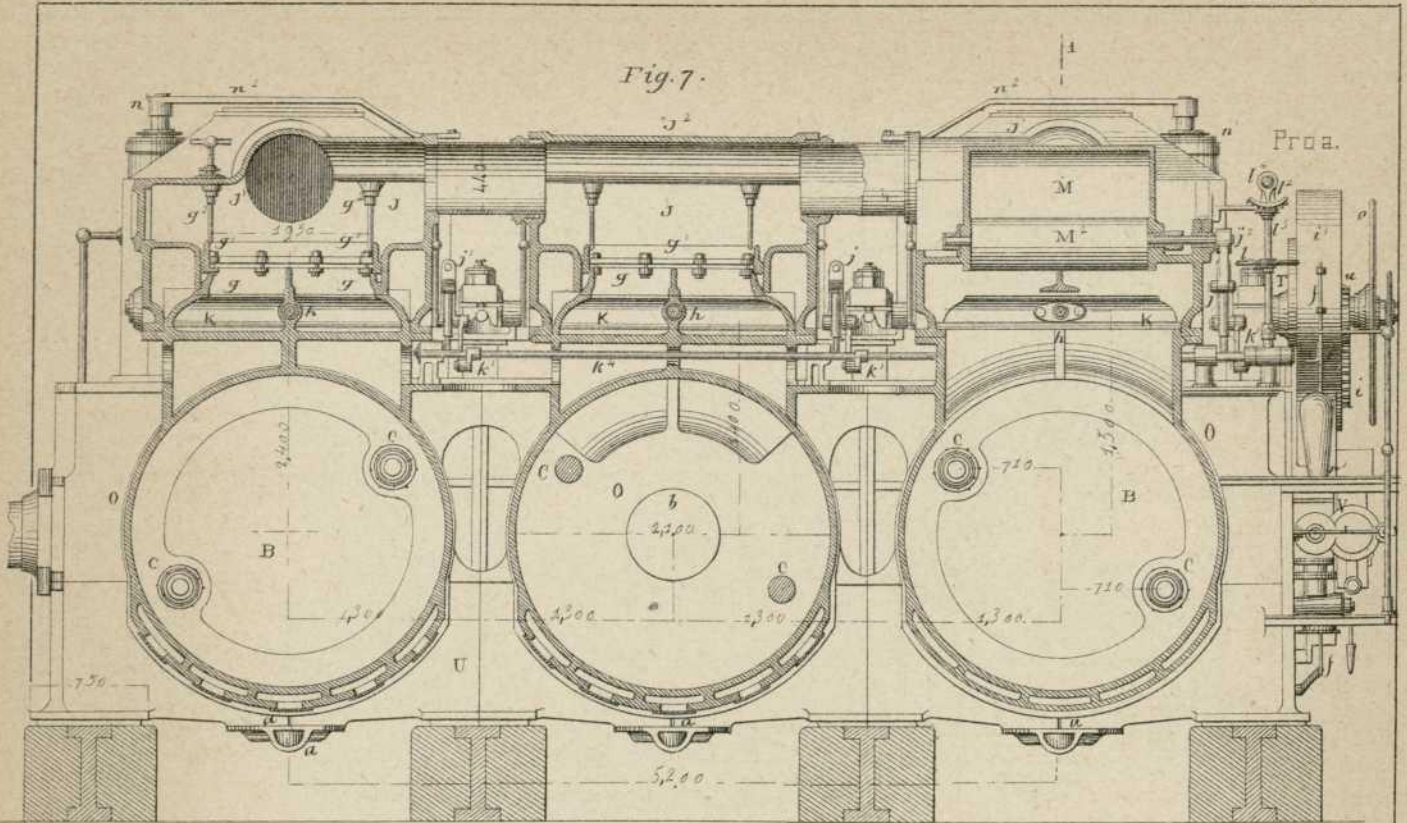


Fig. 6.



Escala de 7/60

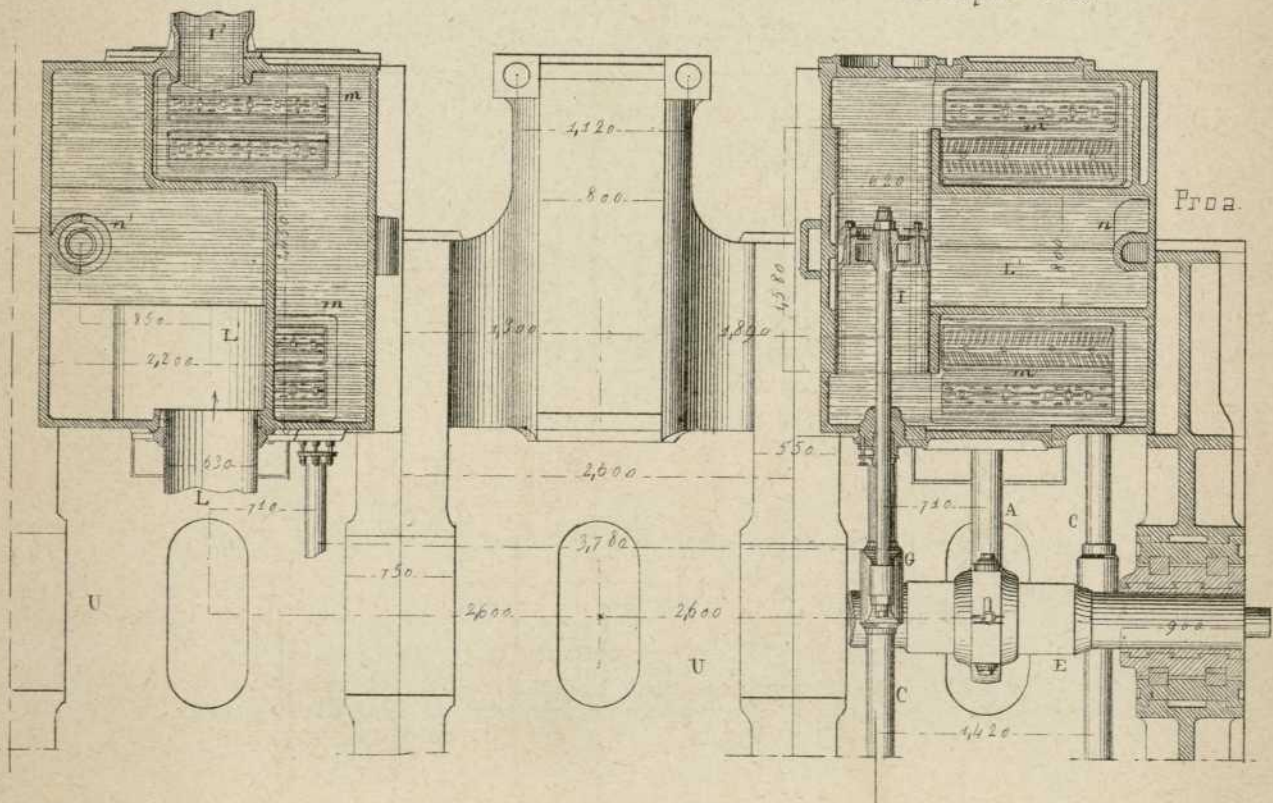
102

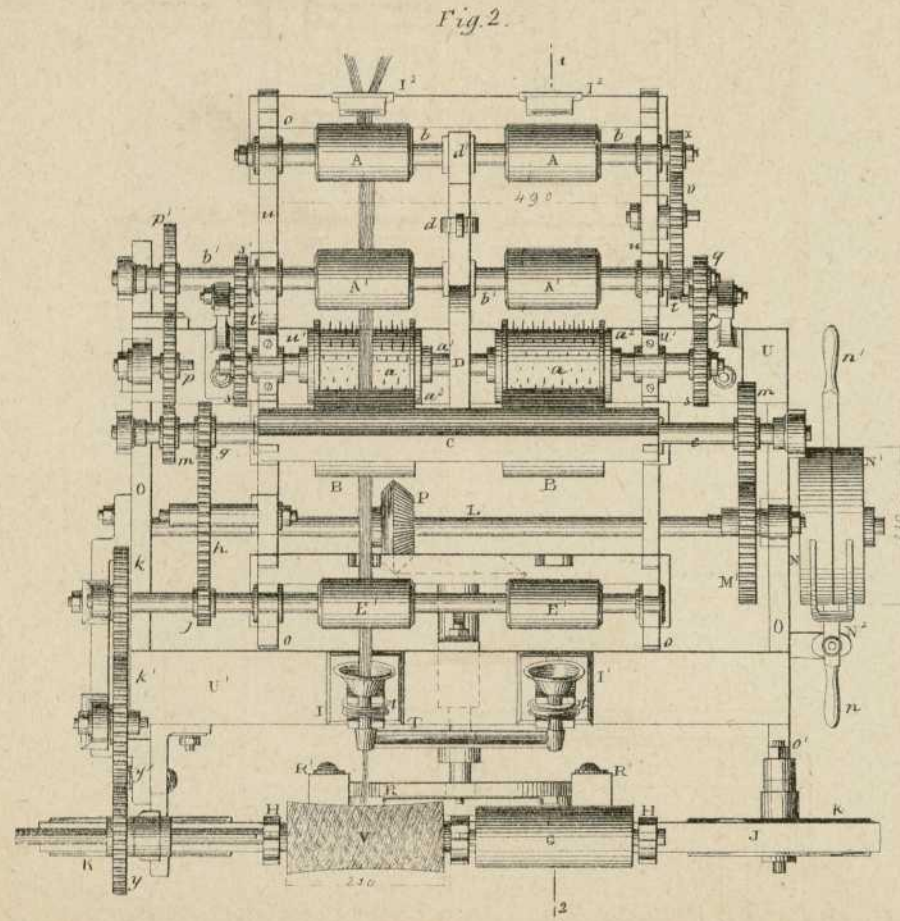


Corte por 11-12.

Fig. 8.

Corte por 9-10.





Escala de 1/10 por las Fig 1 à 5. 1oy 11.

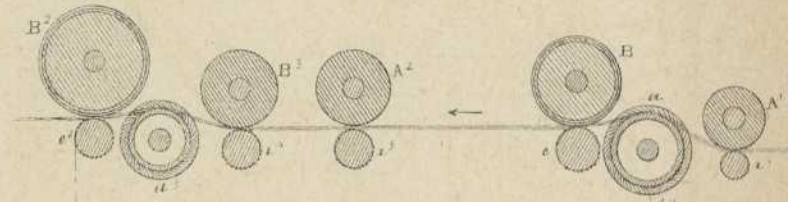
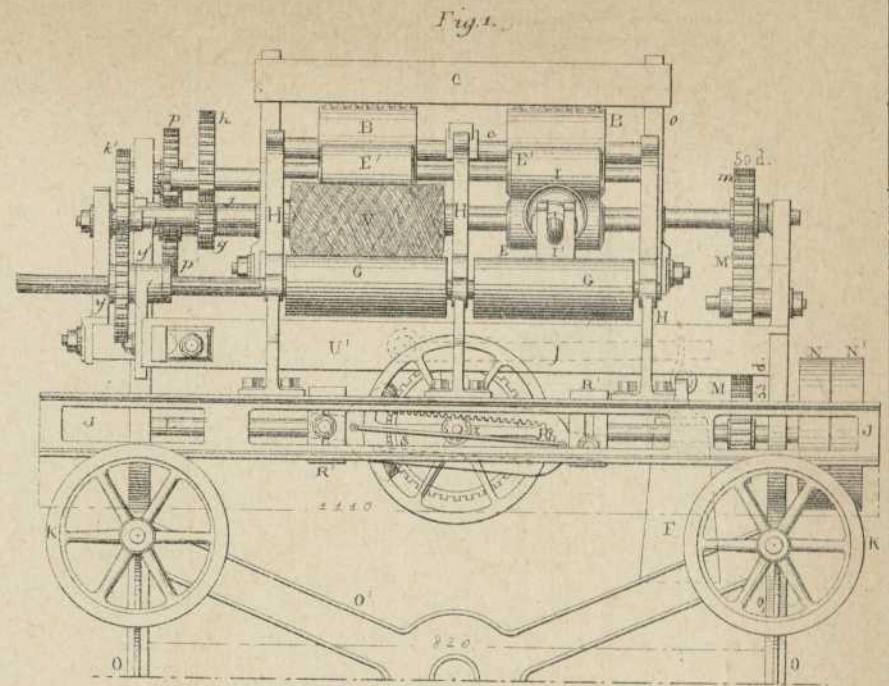
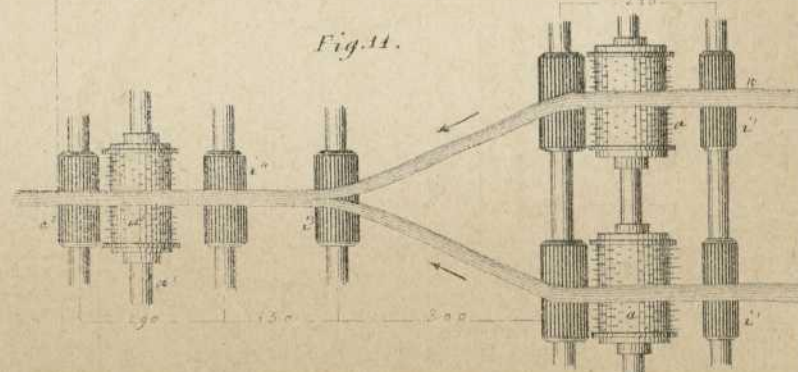


Fig. 11.



Diametro de los cilindros estiradores - 55 mil.
 " " " alimentadores - 42. "
 Carrera del vaiven " " " - 240. "

Fig. 8.

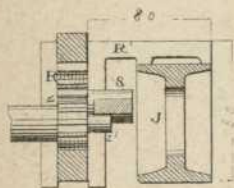
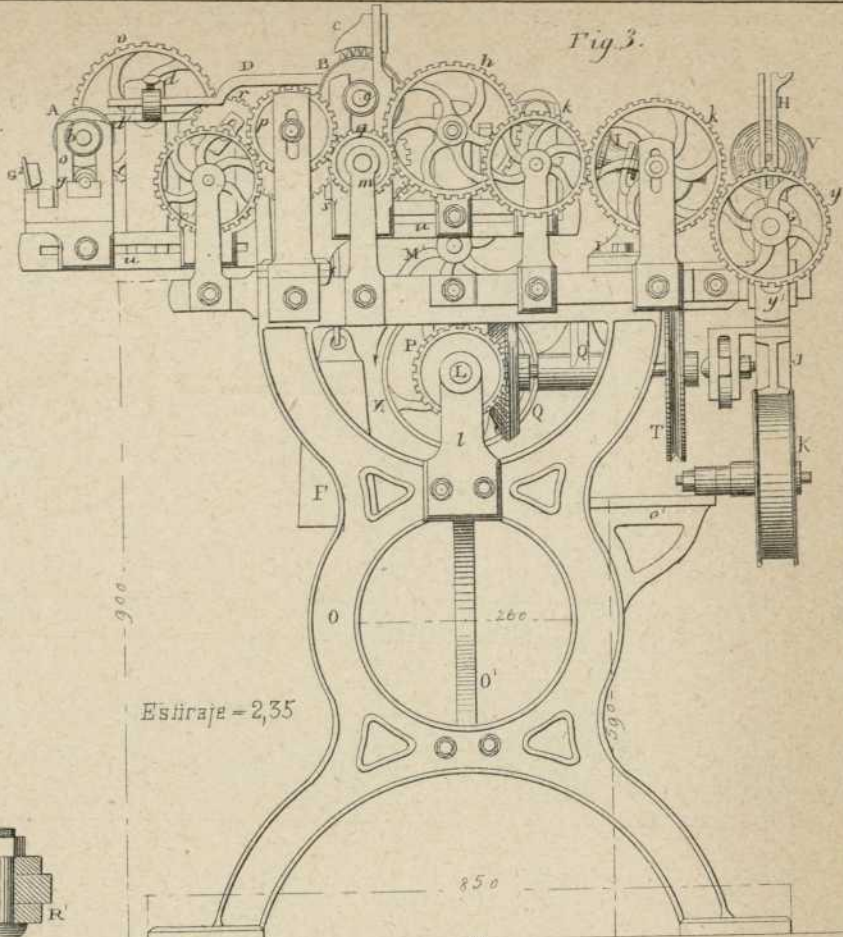
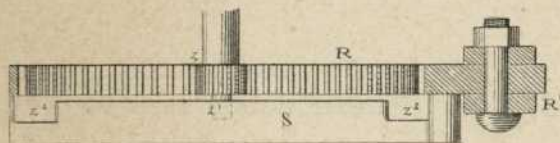


Fig. 7.



Velocidad del árbol motor 140 bueltas
 Presion sobre los cilind. estiradores... 14,5 Kil.
 " " " alimentadores... 25 Kil. 80

Fig. 5.

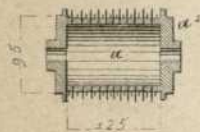
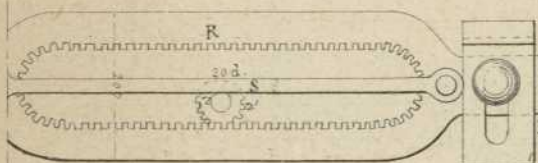


Fig. 6.



Escala de 1/45

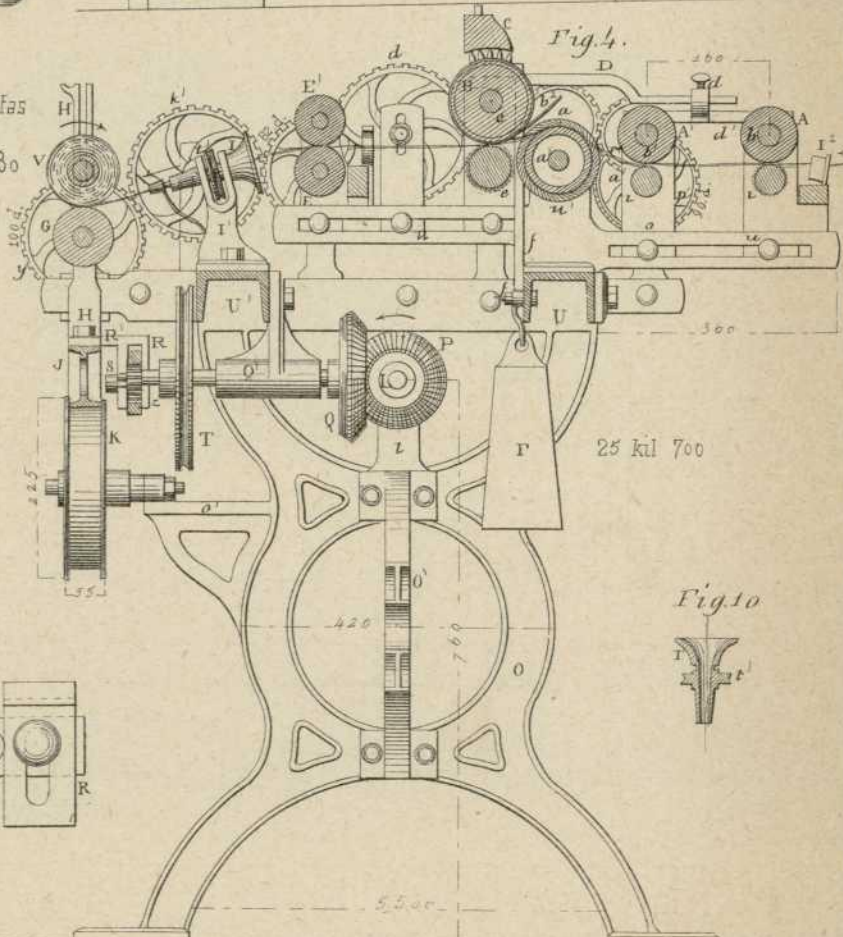


Fig. 10



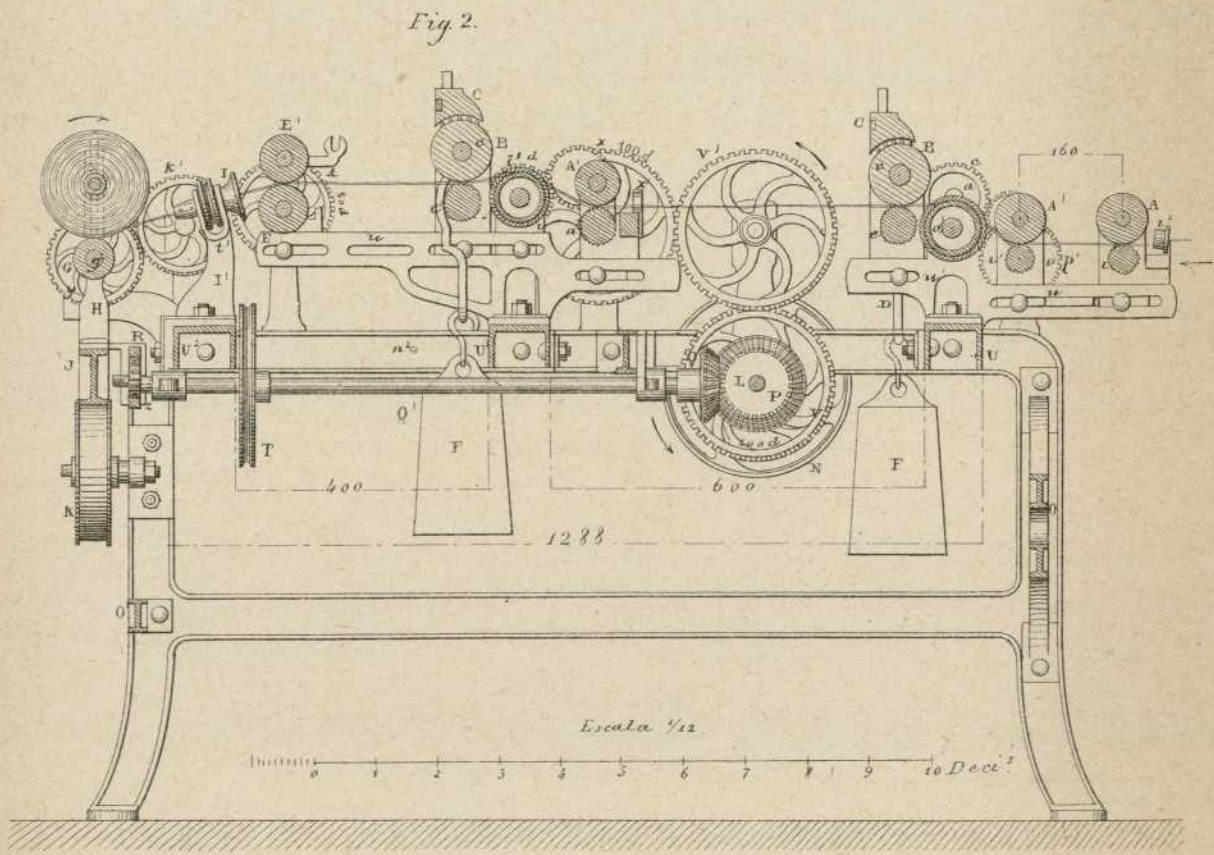
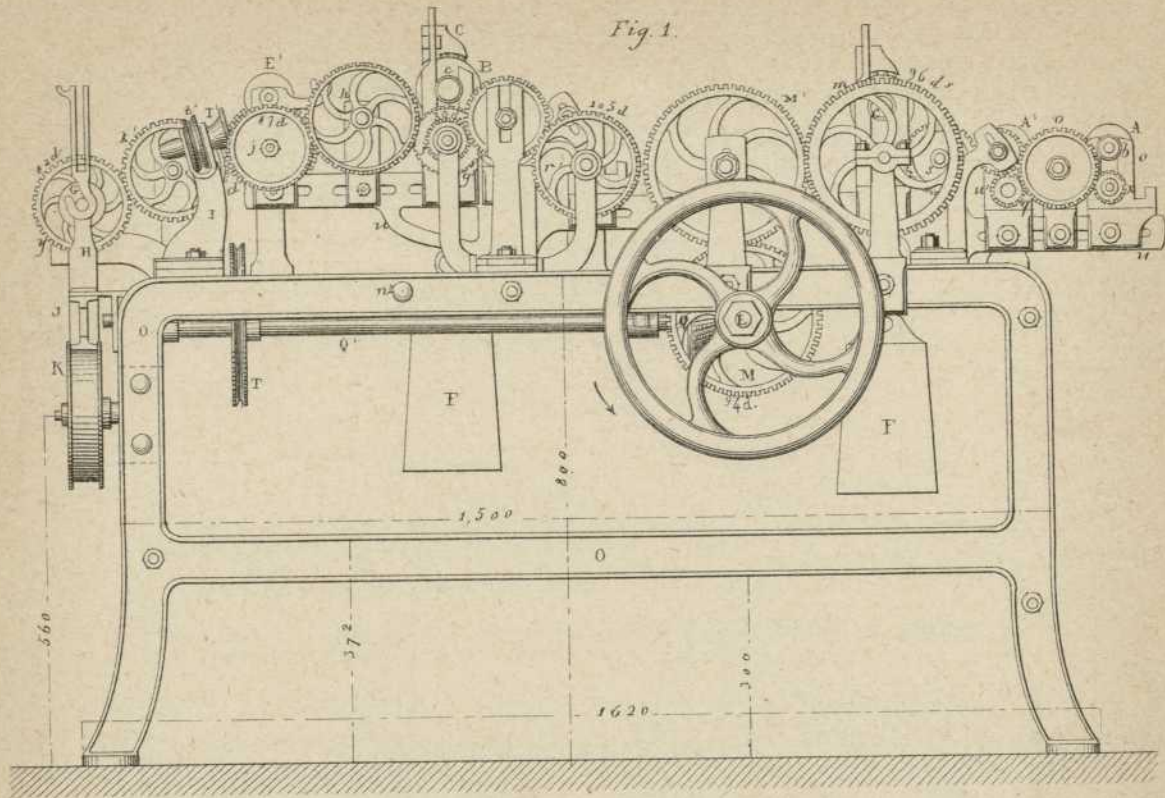
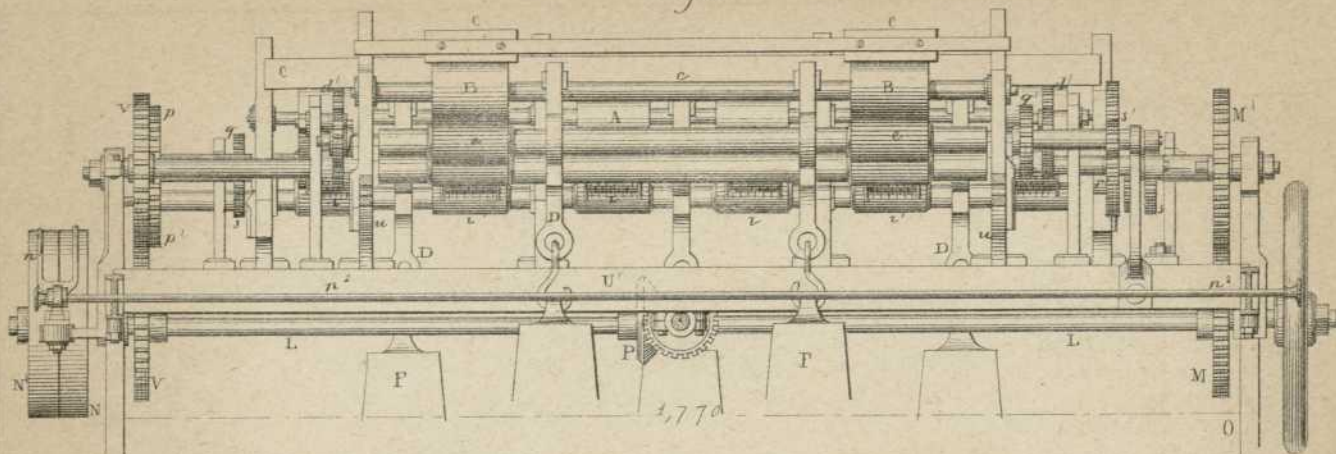
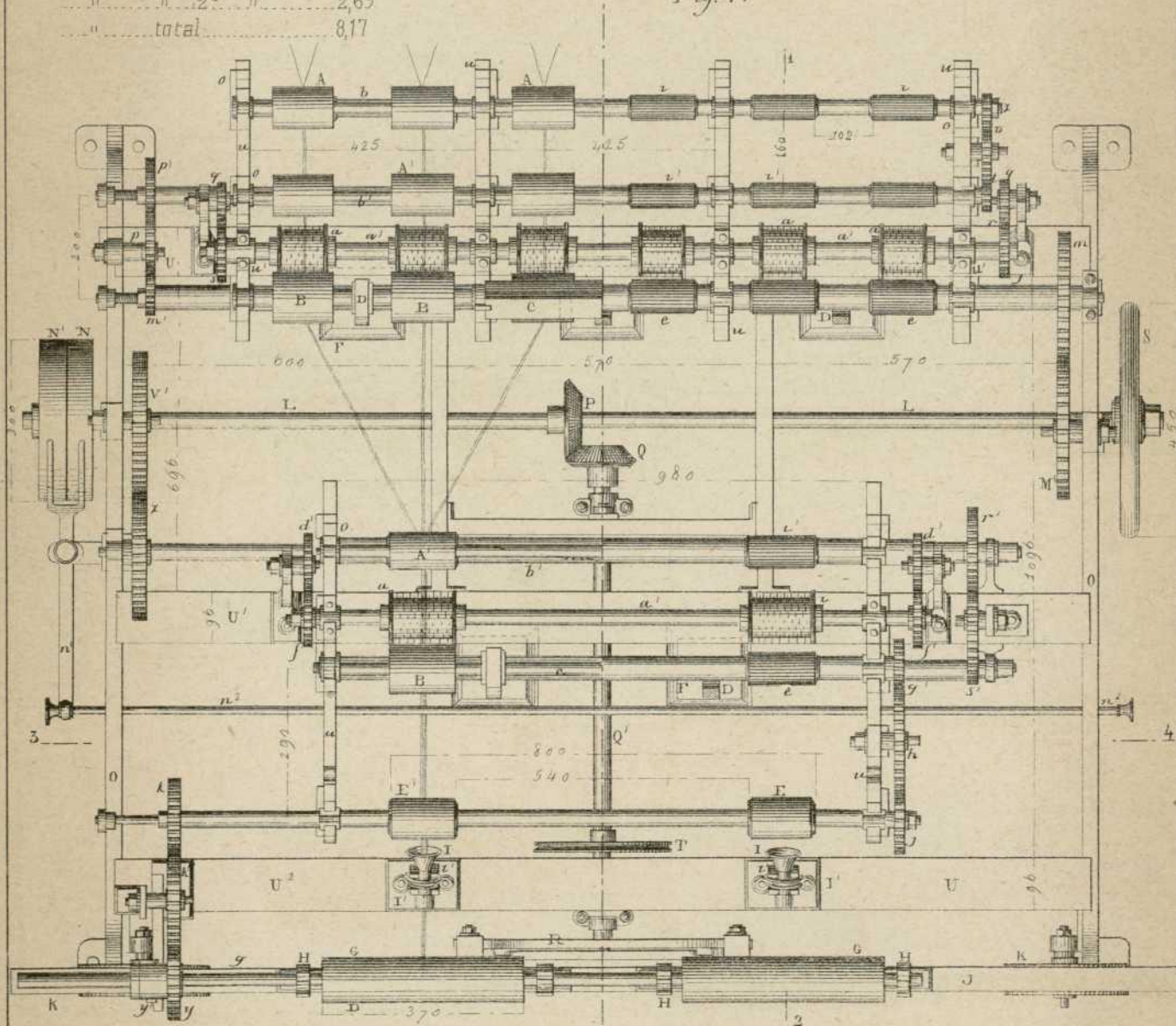


Fig. 3.

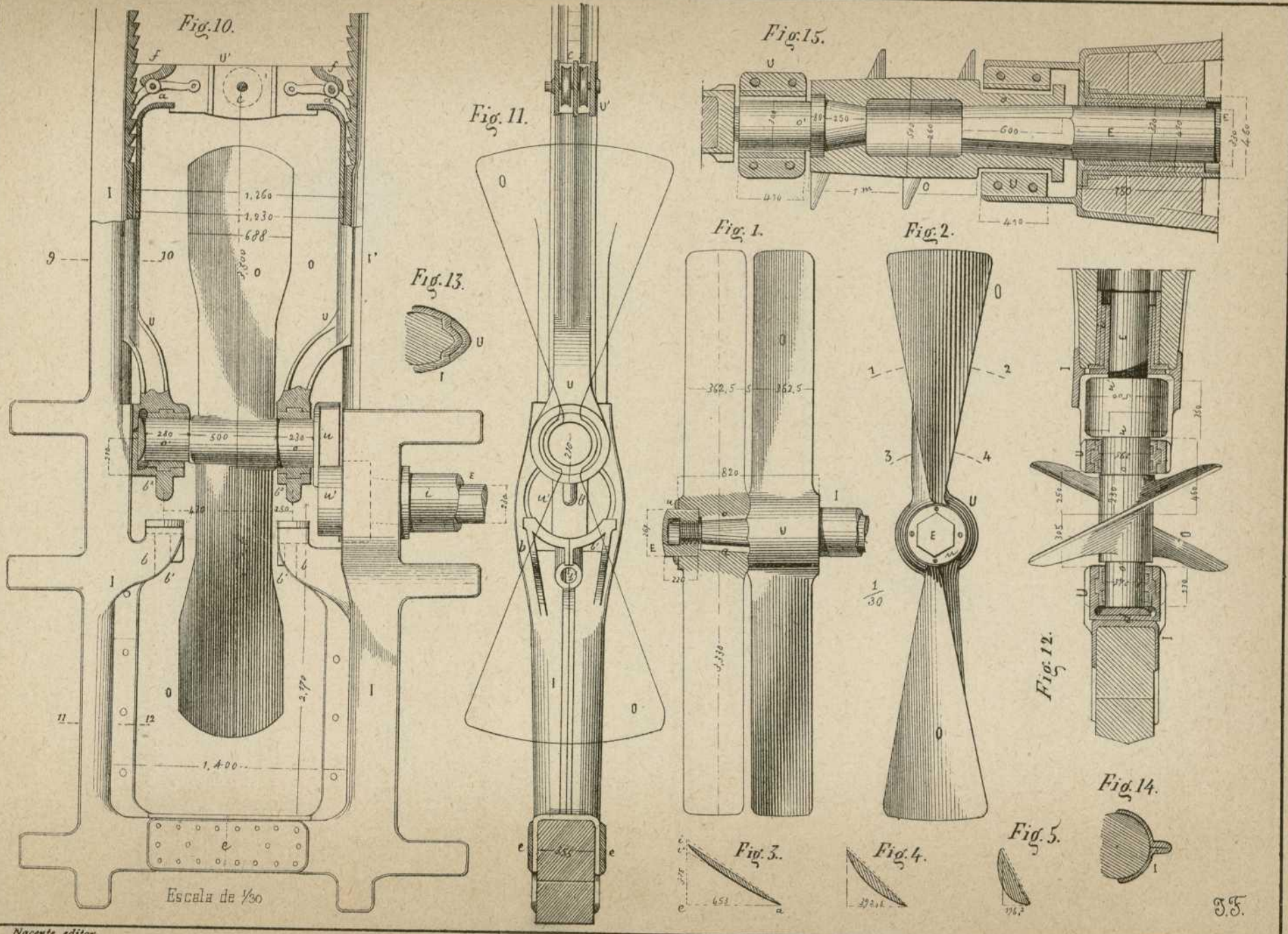


Velocidad del árbol motor = 100 vueltas
 Estiraje de la 1ª cabeza 3,04
 " " 2ª " 2,69
 " total 8,17

Fig. 4.



BS



Naonte, editor.

35.

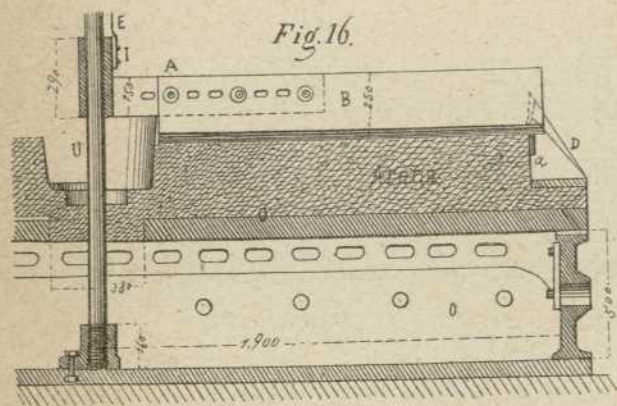
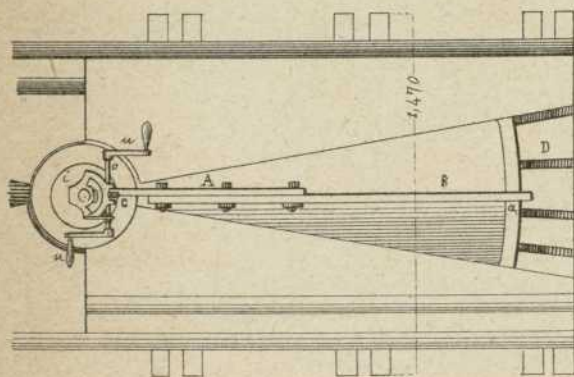
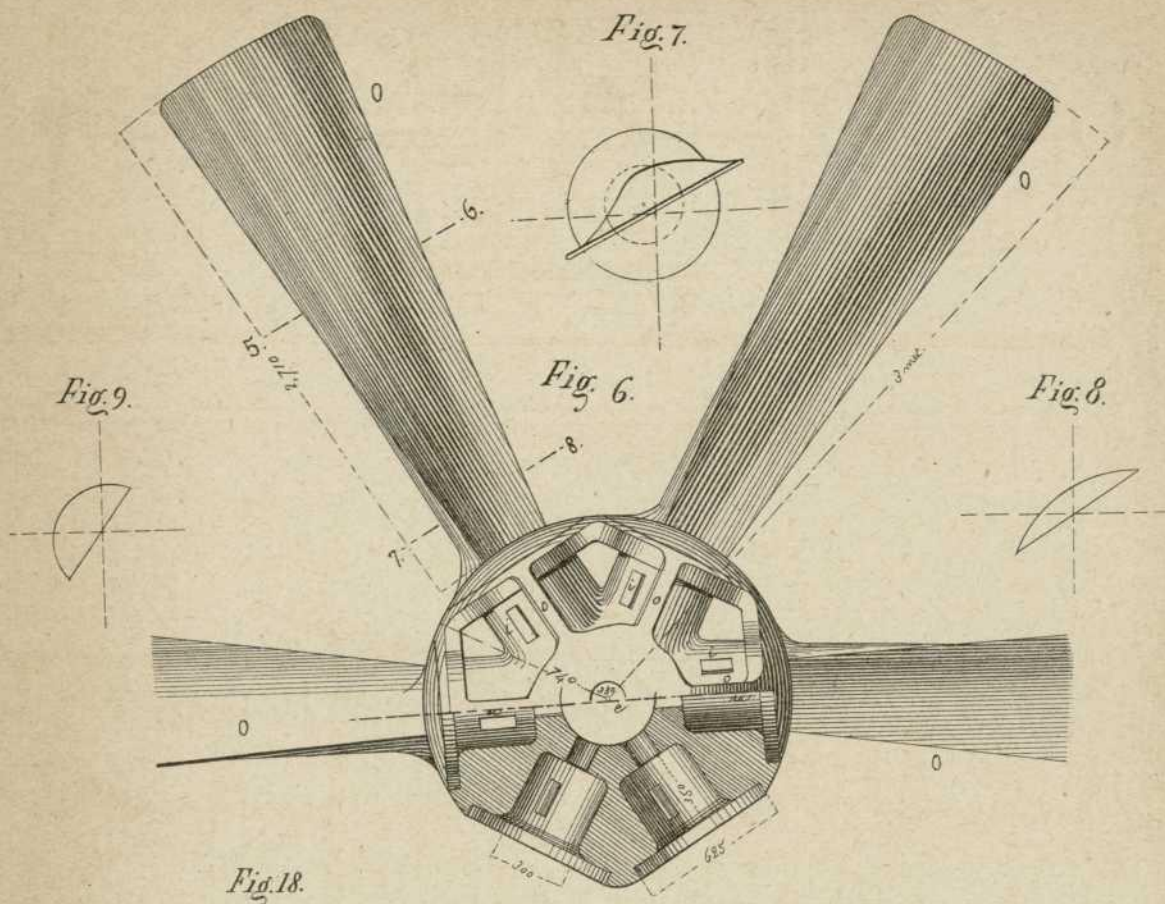


Fig. 19.

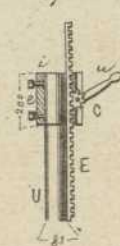
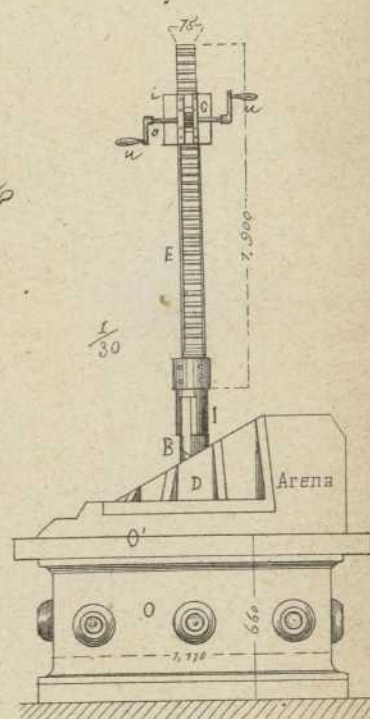


Fig. 17.



33

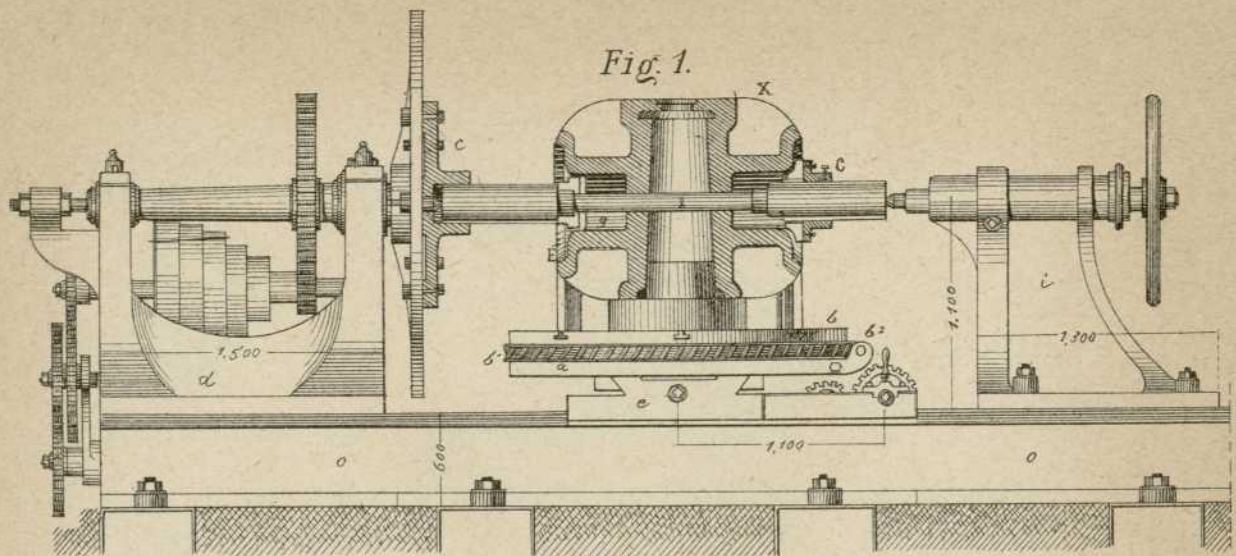


Fig. 1.

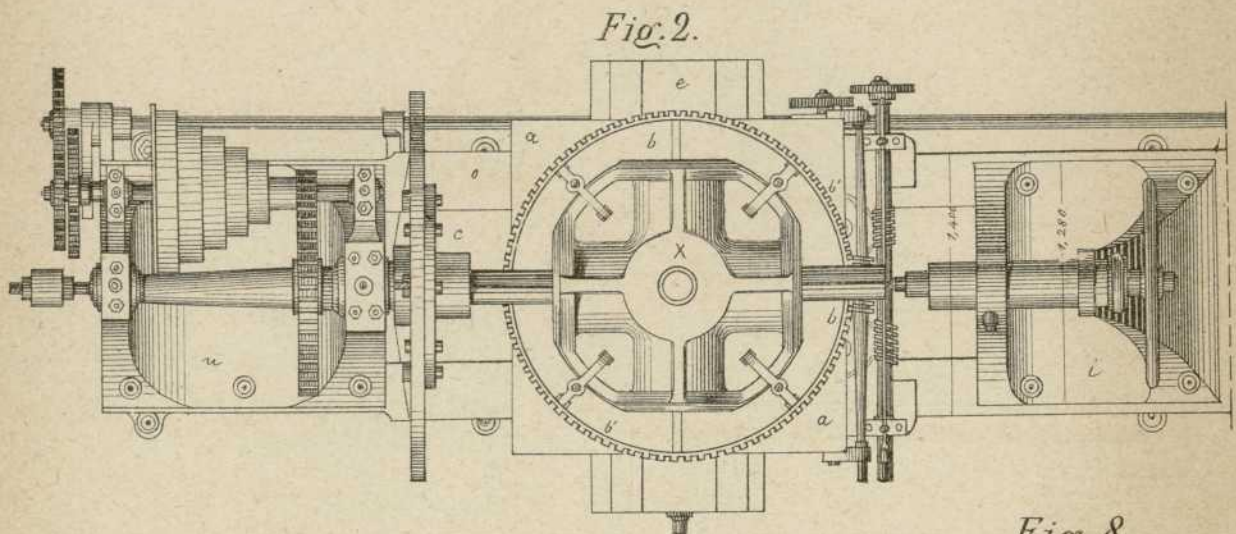


Fig. 2.

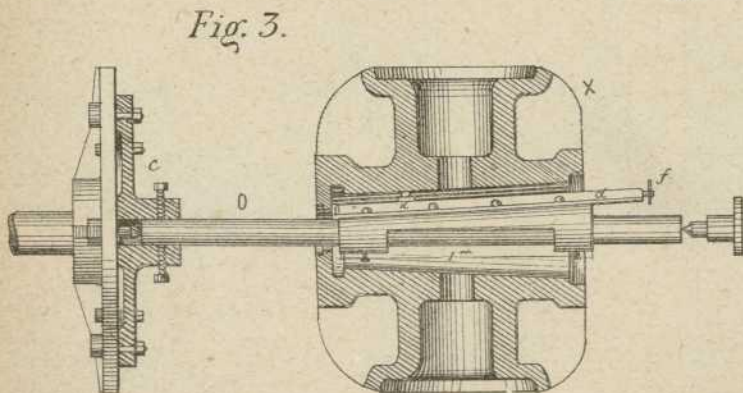


Fig. 3.

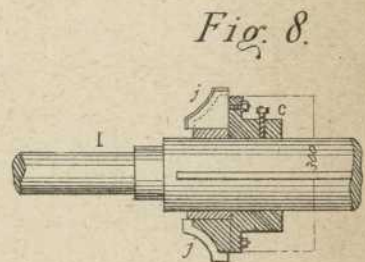


Fig. 8.



Fig. 4.

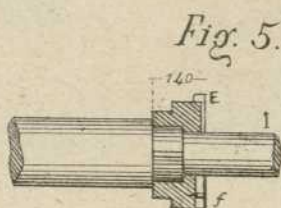


Fig. 5.

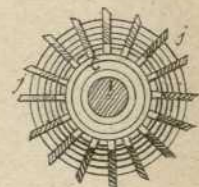


Fig. 9.

Escala de $\frac{1}{40}$ por las Fig 1 y 2

J F

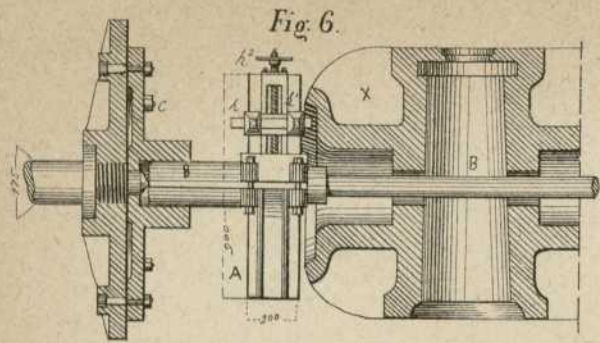


Fig. 6.

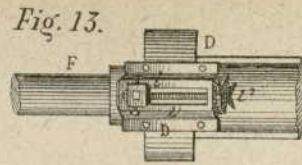


Fig. 13.

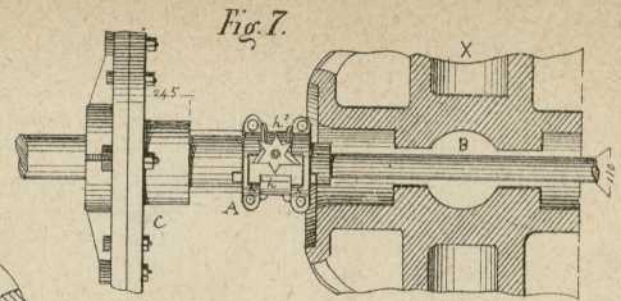


Fig. 7.

Fig. 16.

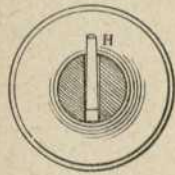


Fig. 17.

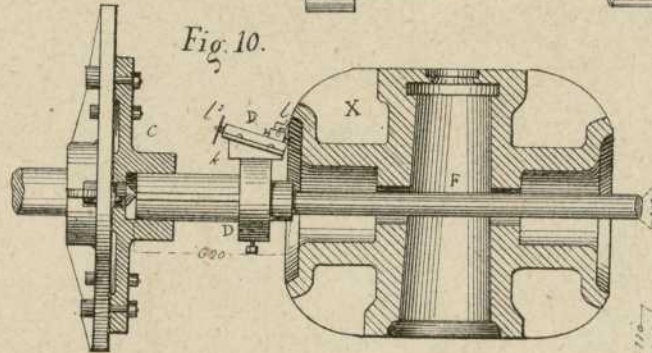
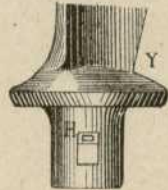


Fig. 10.

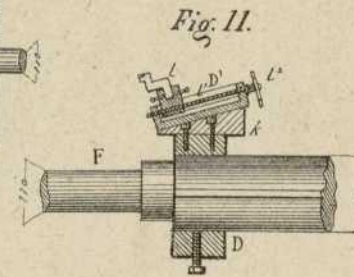


Fig. 11.

Fig. 12.

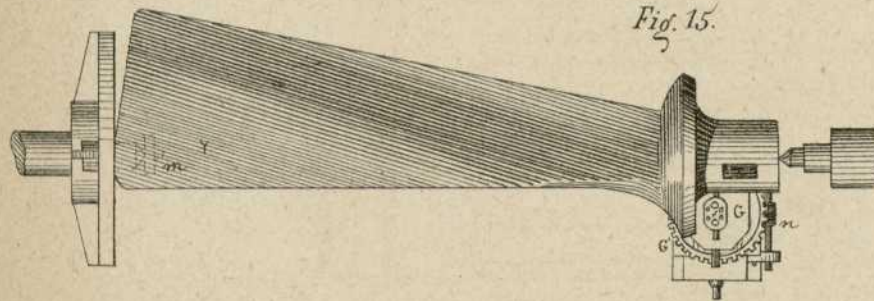
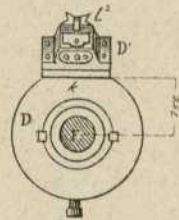


Fig. 15.



Fig. 14.

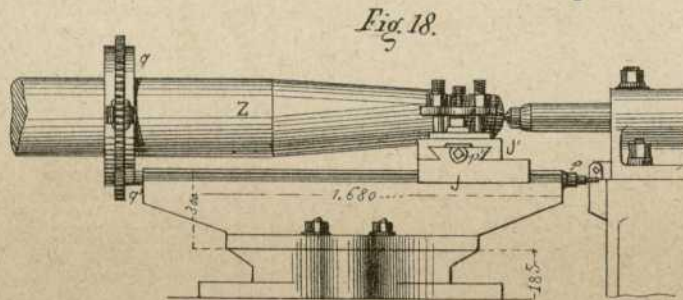


Fig. 18.

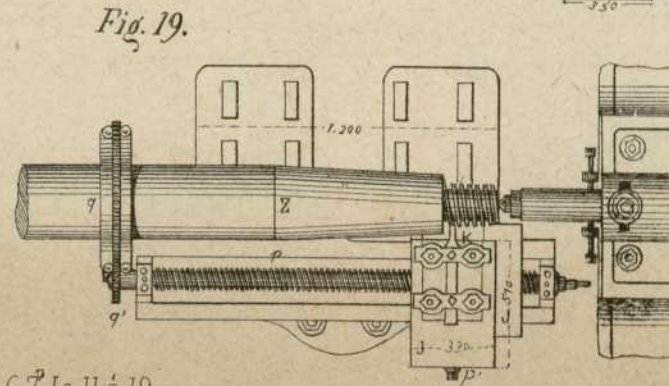
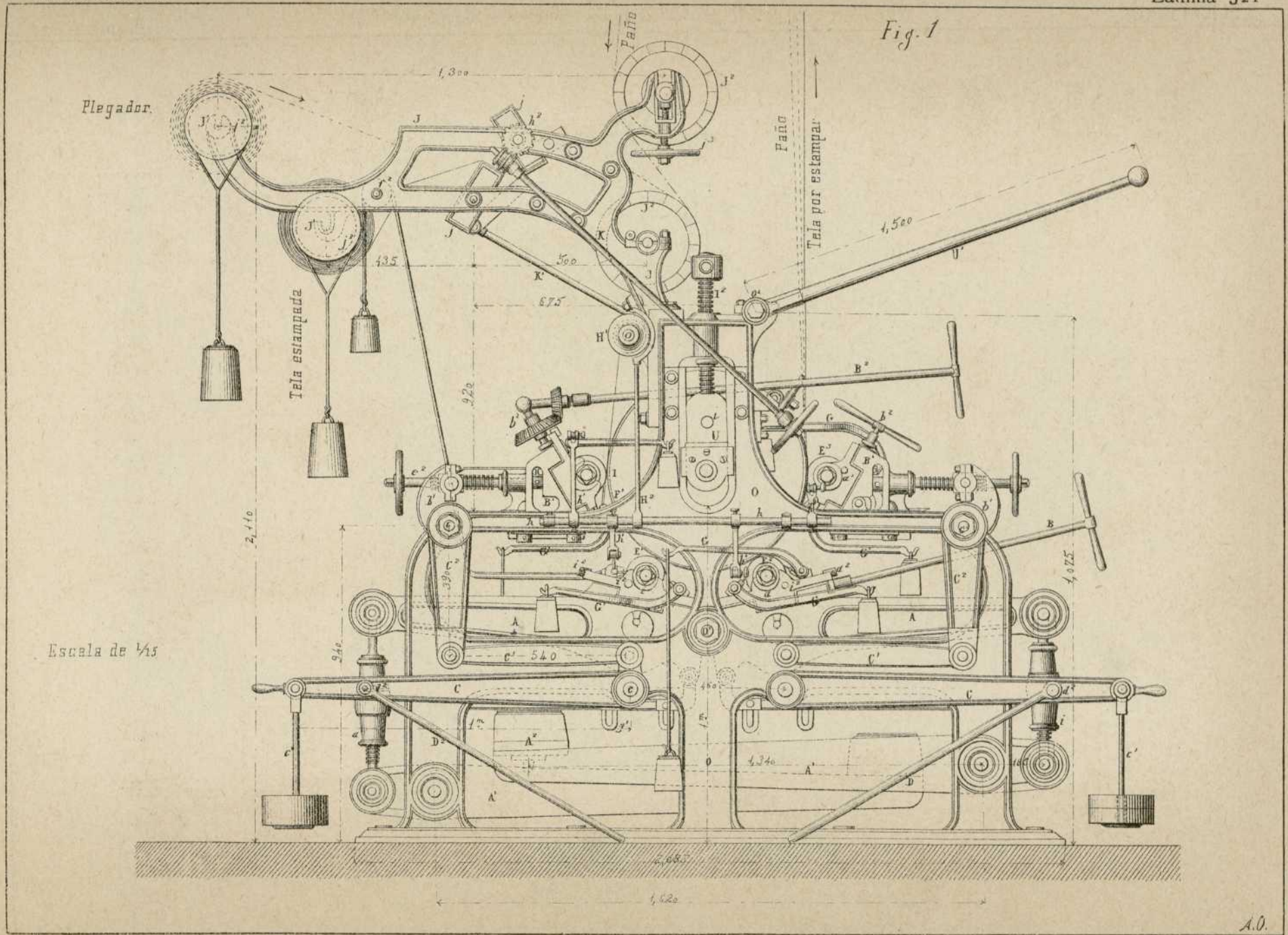


Fig. 19.

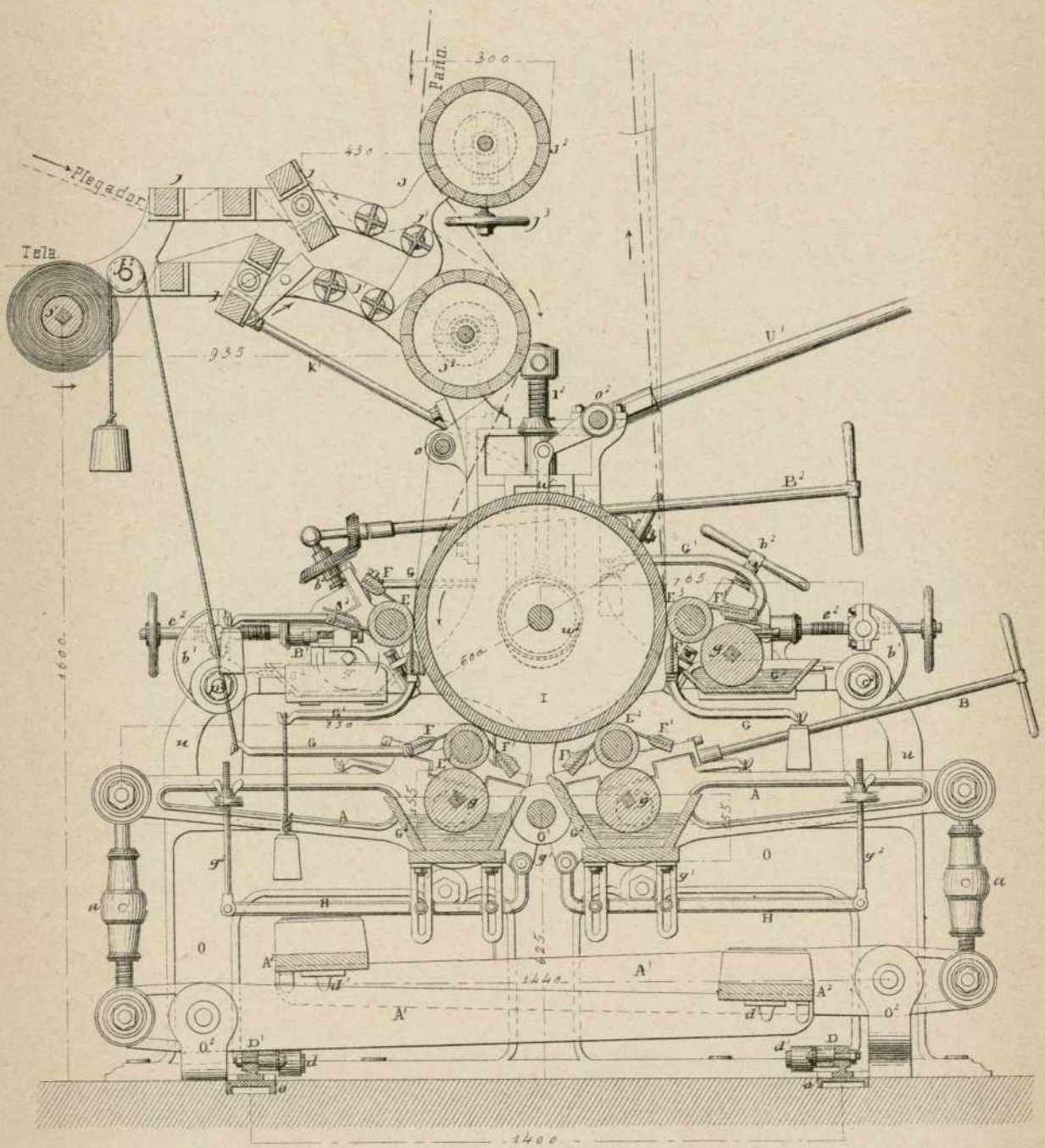
Escala de 1/30 para las Fig. 3, 6, 7, 10, 11 a 19

J.F.



Escala de 1/15

Fig. 2.



Escala de 1/5

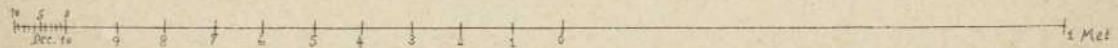
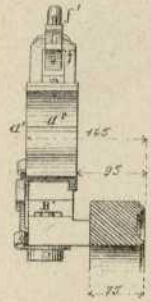


Fig. 7



1/40

Fig. 8

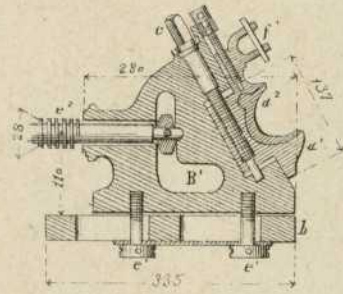
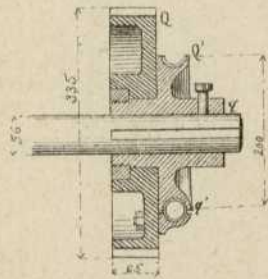


Fig. 10



1/10

Fig. 9

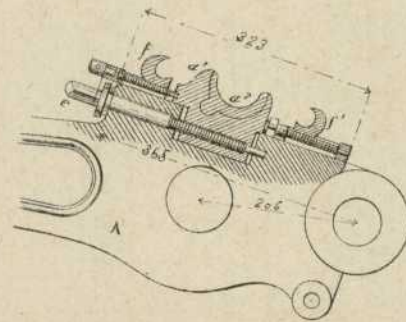
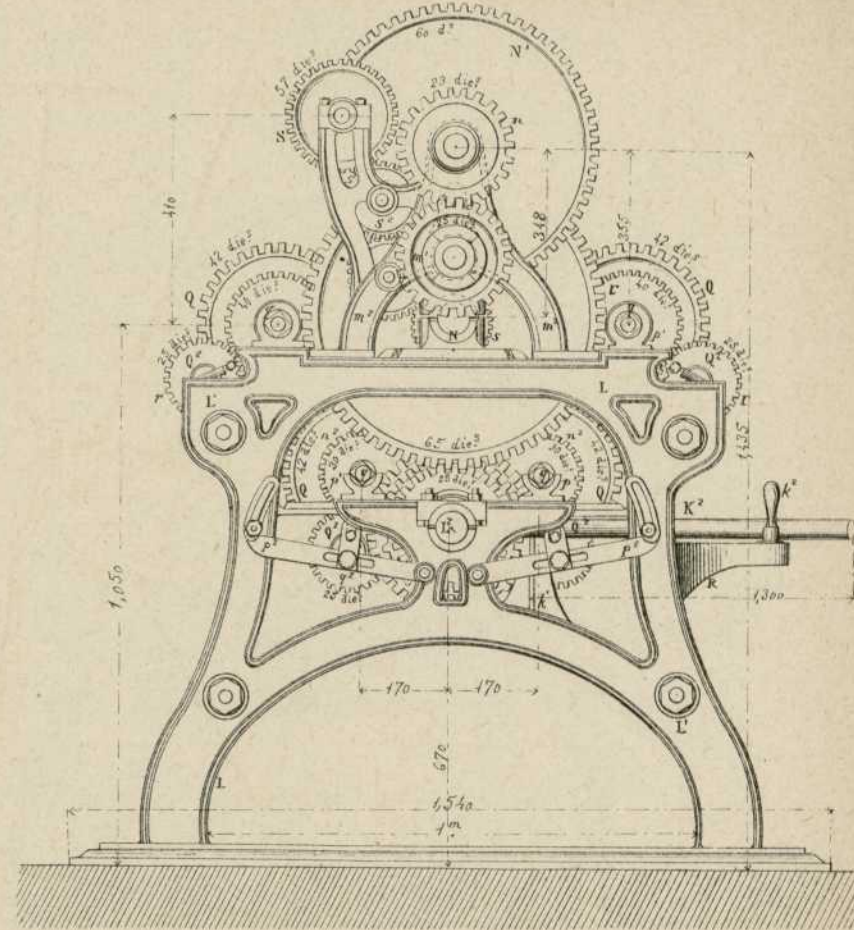
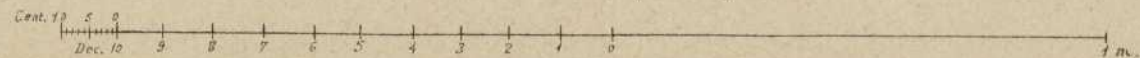
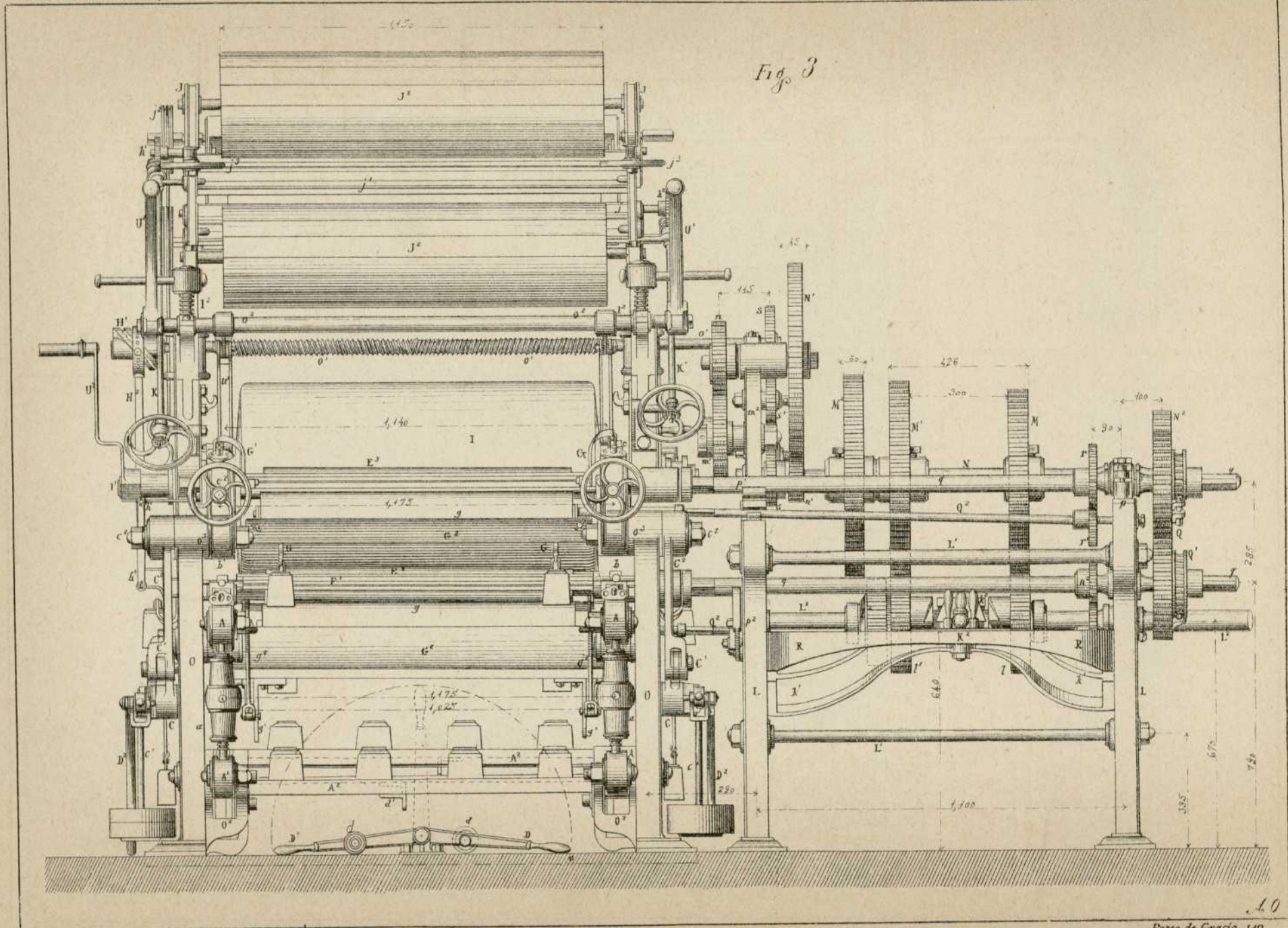


Fig. 4



Escala de 1/3 por las fig 3 y 4





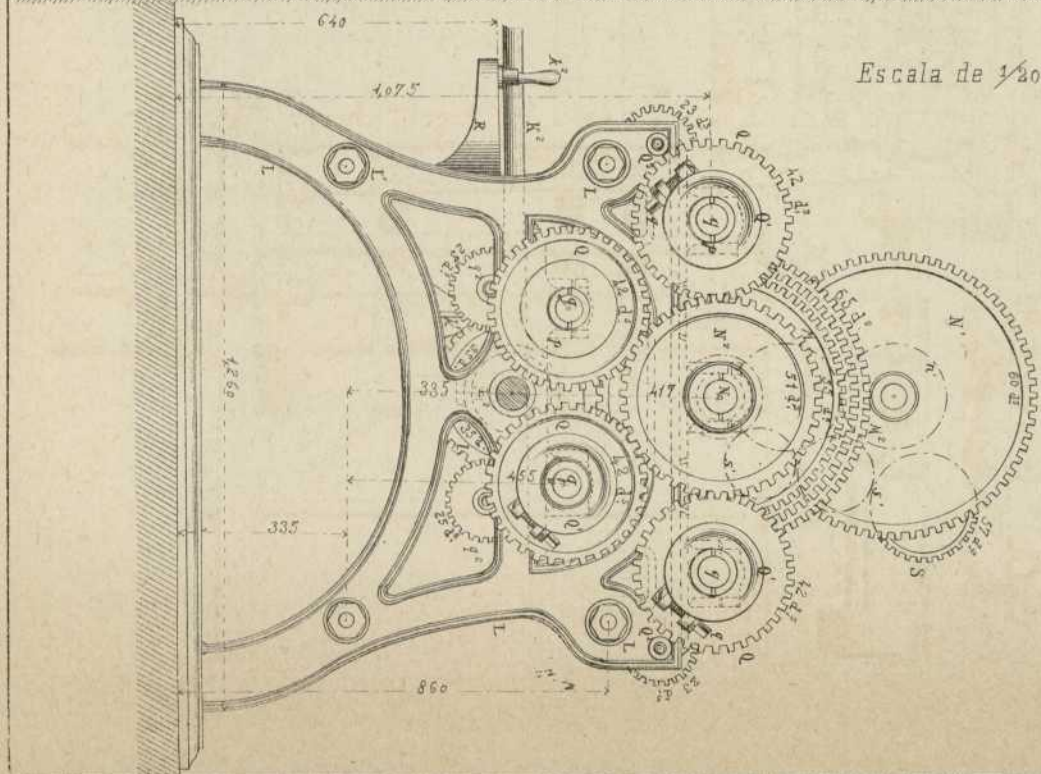
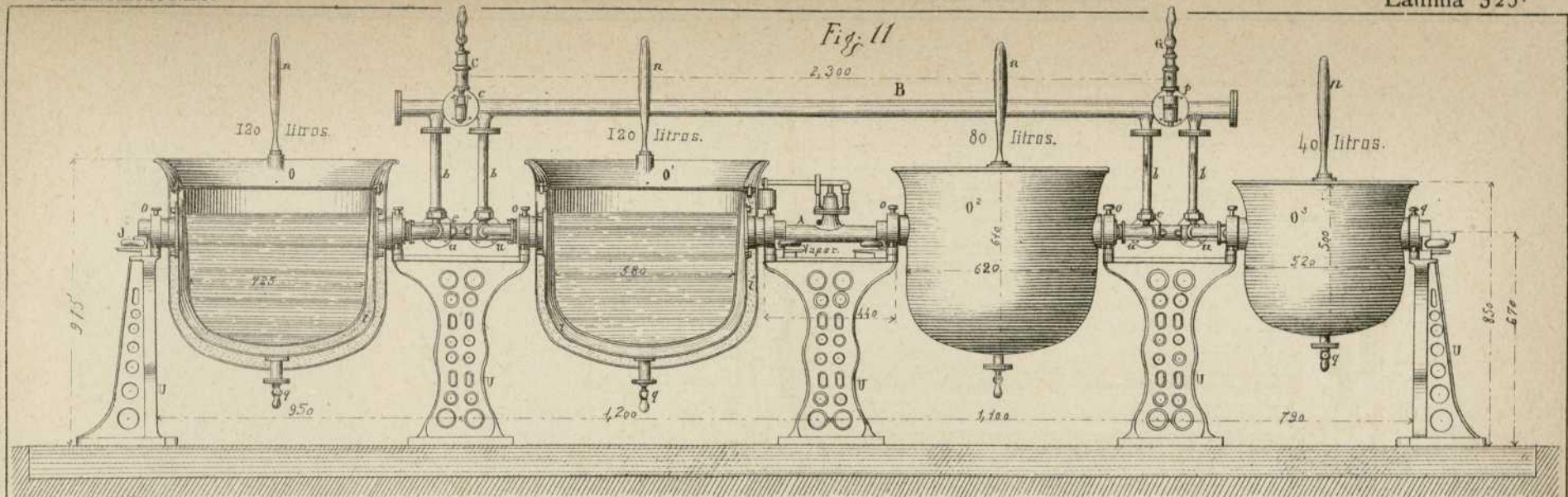


Fig. 6

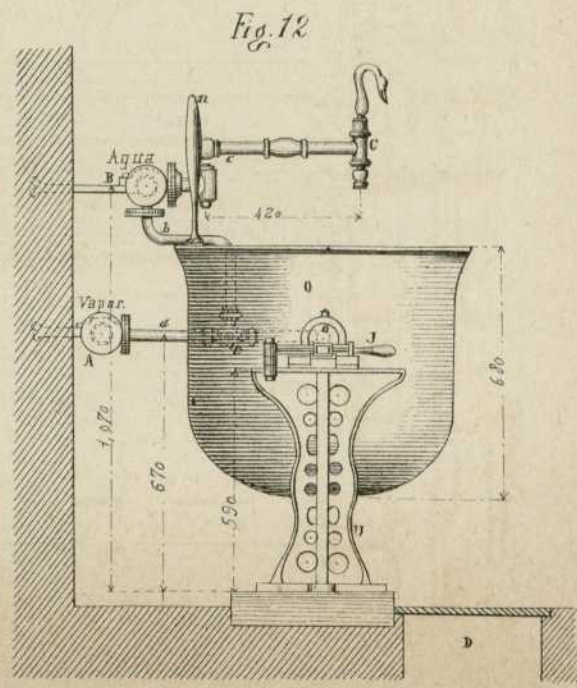
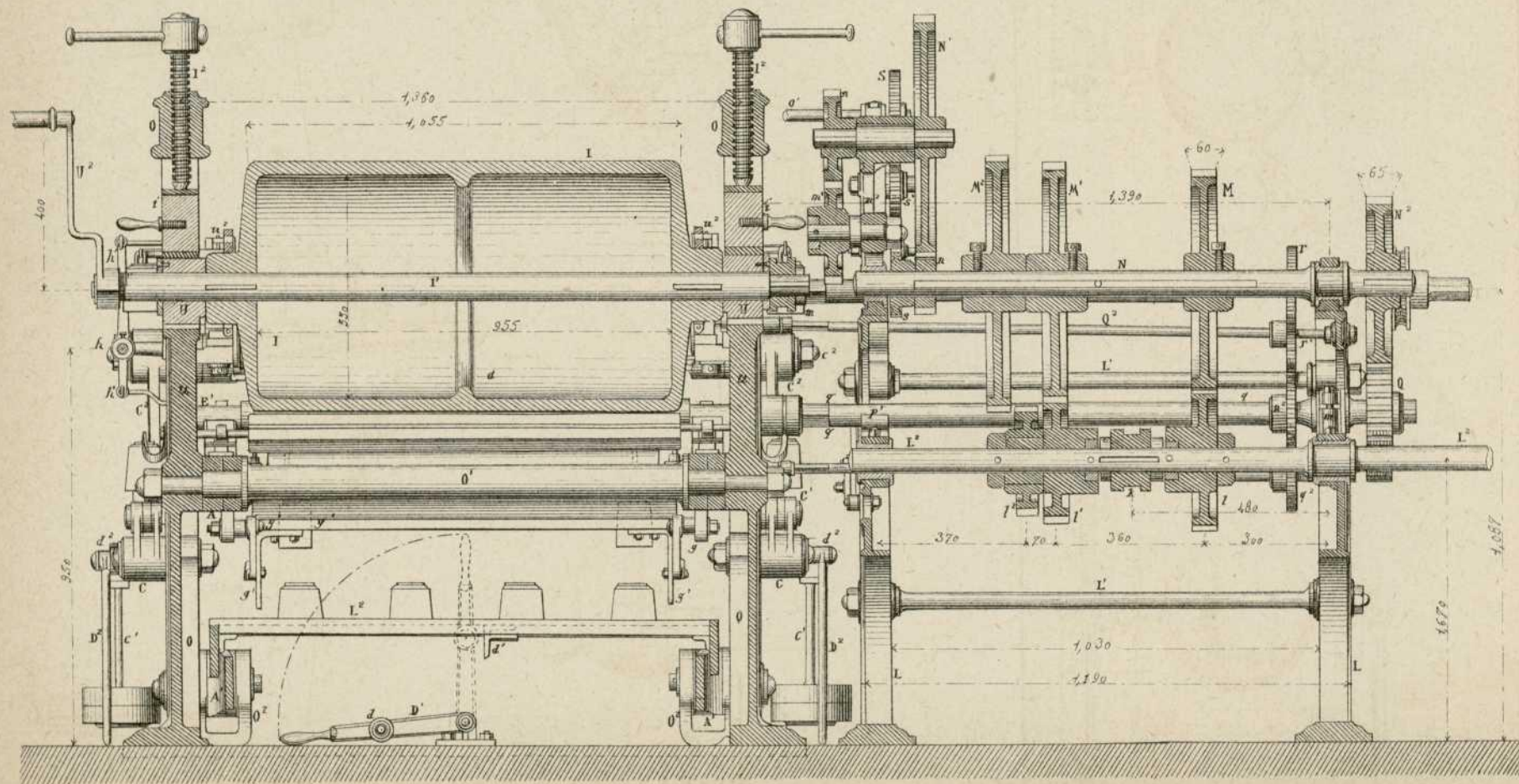


Fig. 12

A.O

Fig. 5



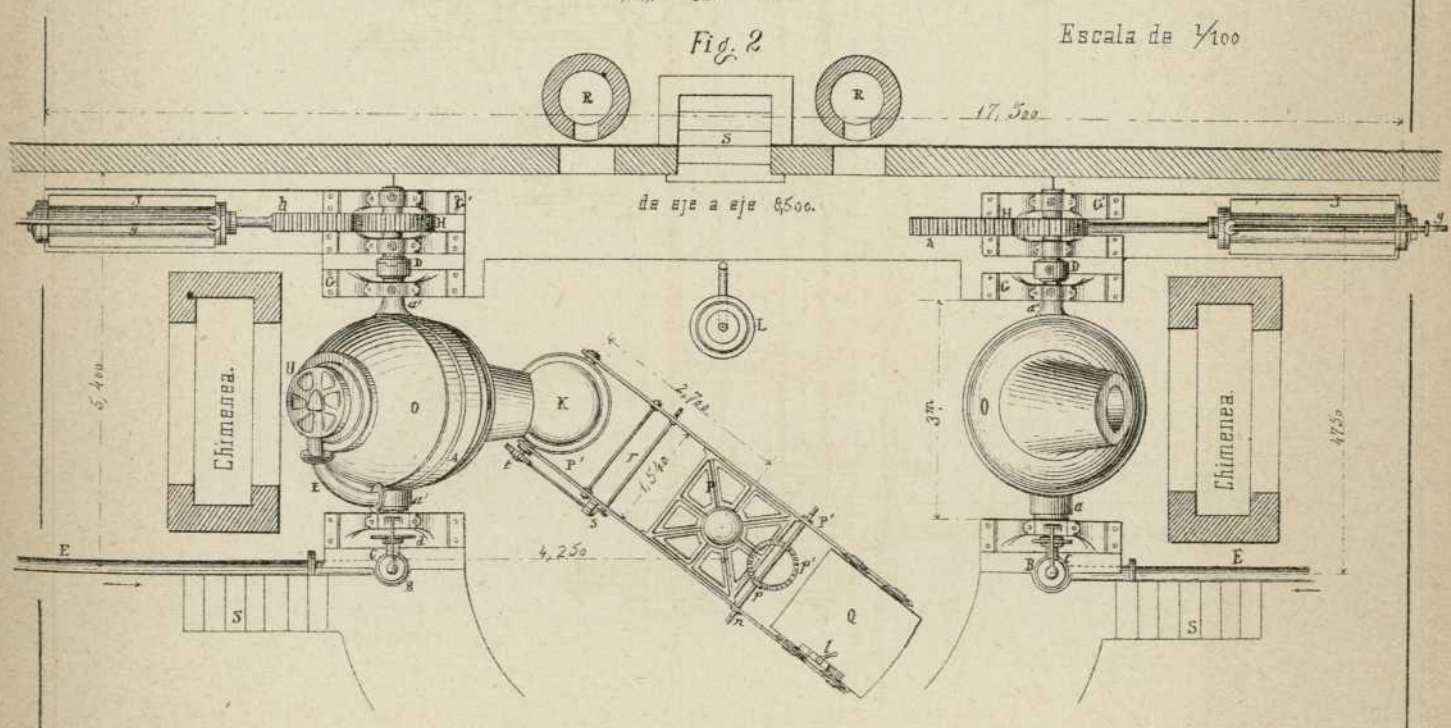
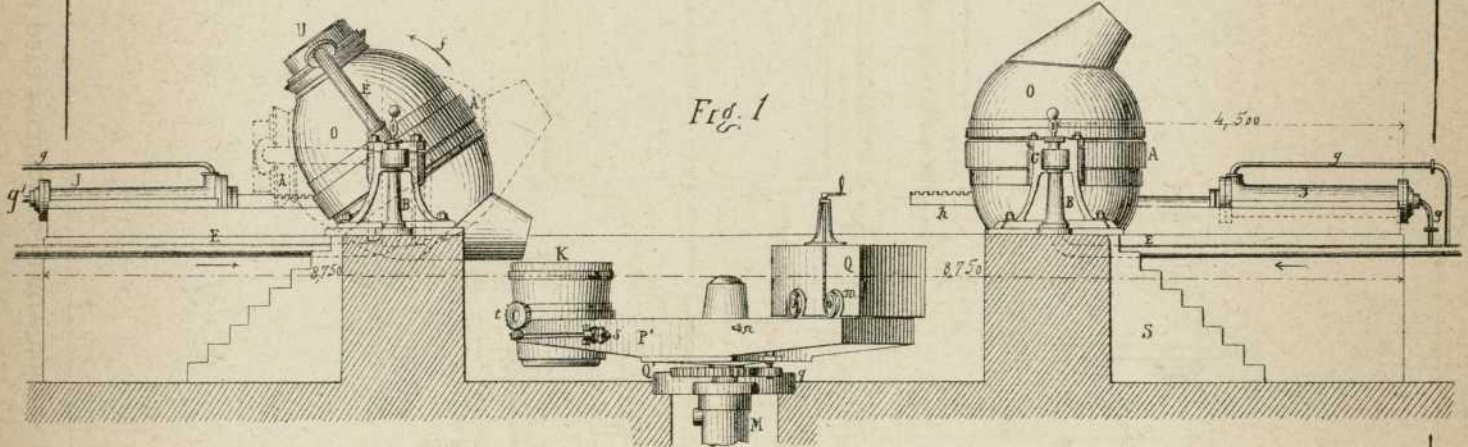
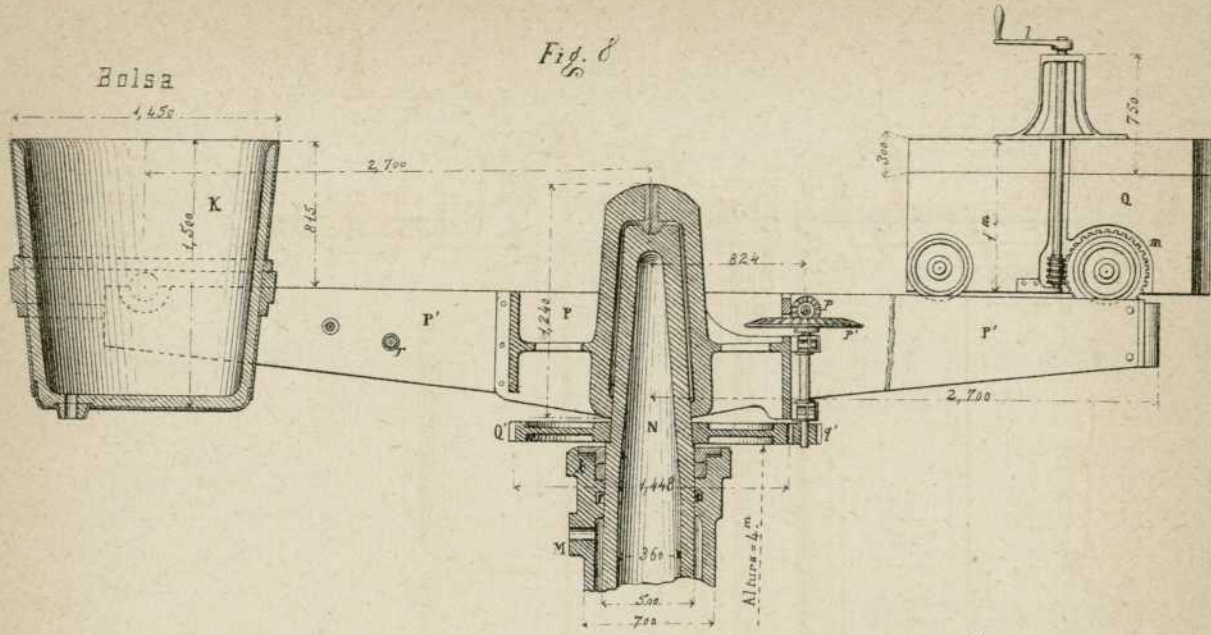


Fig. 1

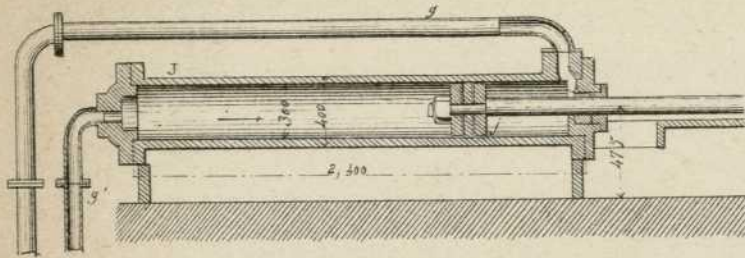


Fig. 9

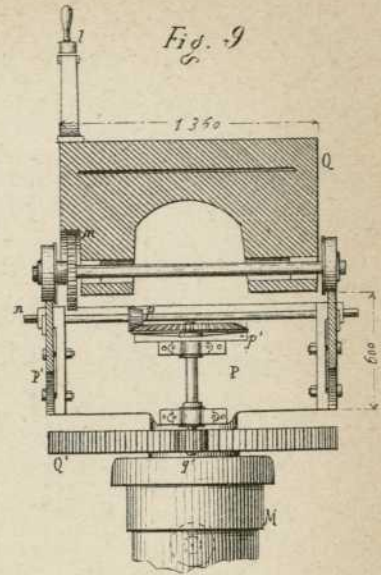


Fig. 5

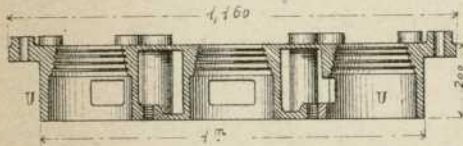


Fig. 3

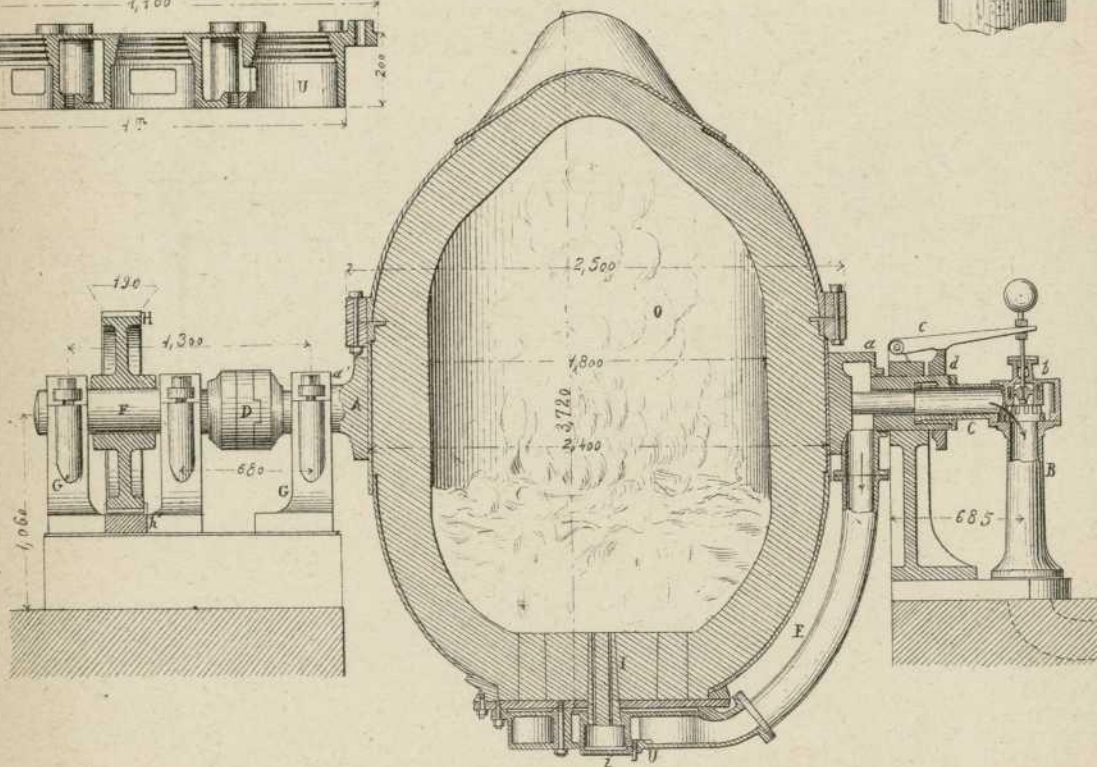


Fig. 4

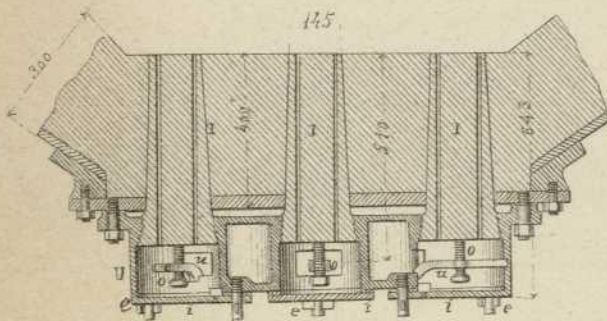
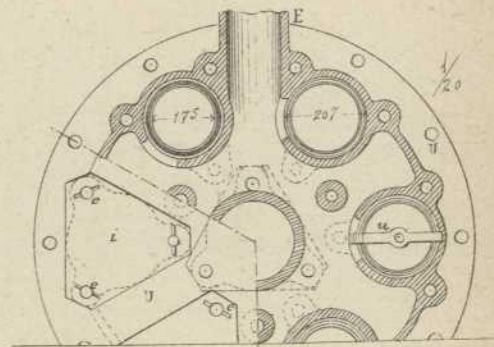


Fig. 6



Escala de 1/40 por las Fig. 3, 7 a 9

Fig. 15

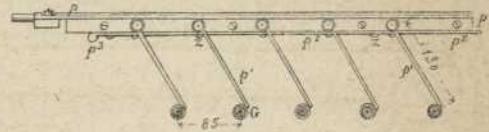


Fig. 2

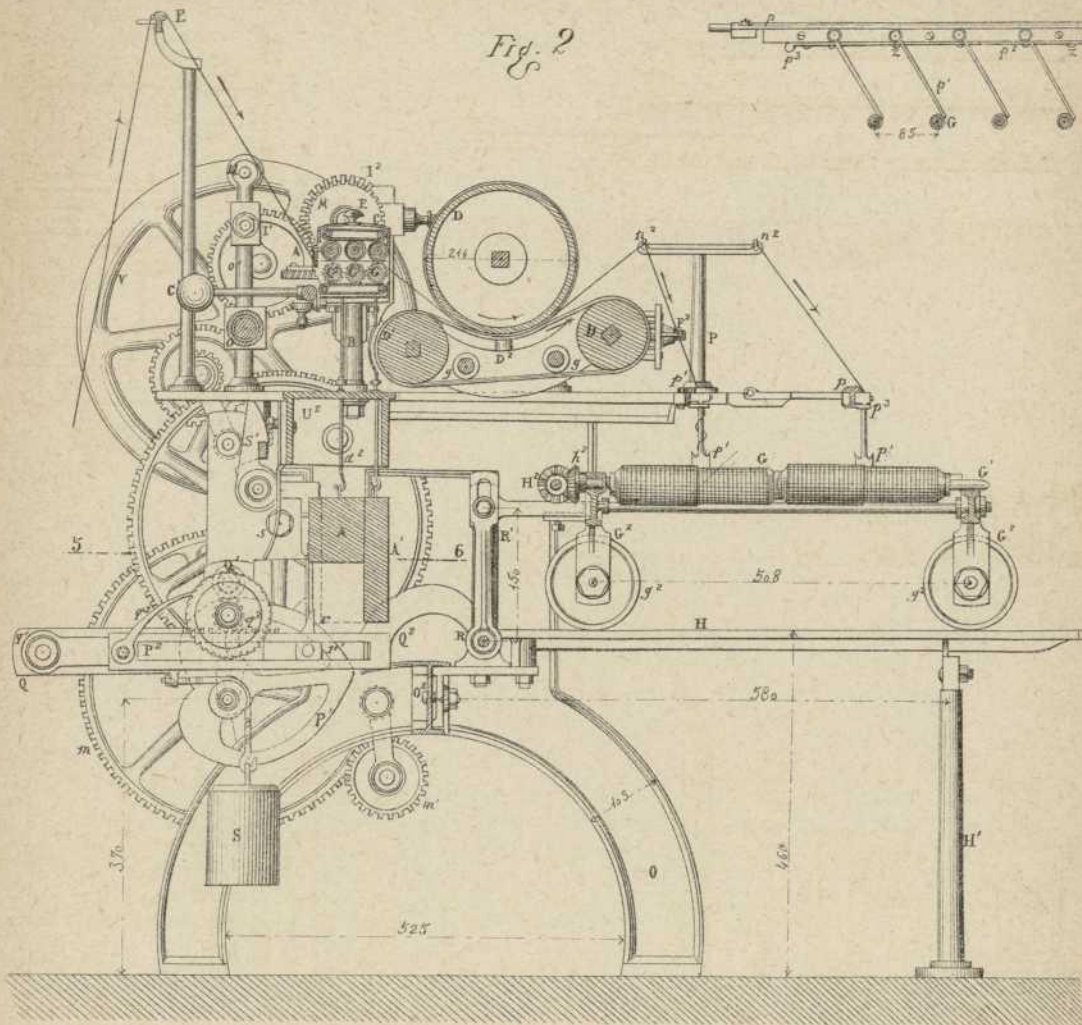


Fig. 16

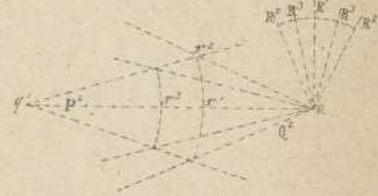
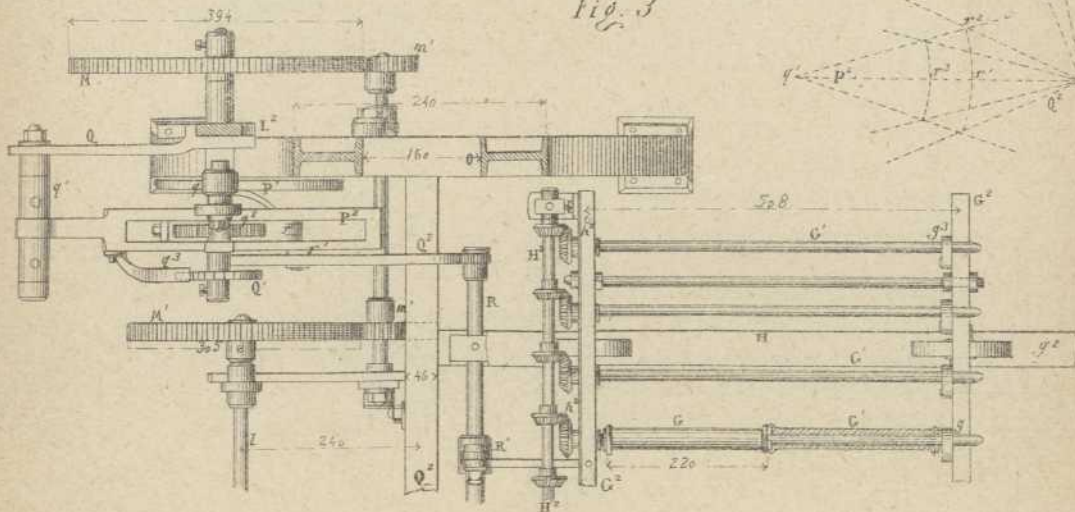
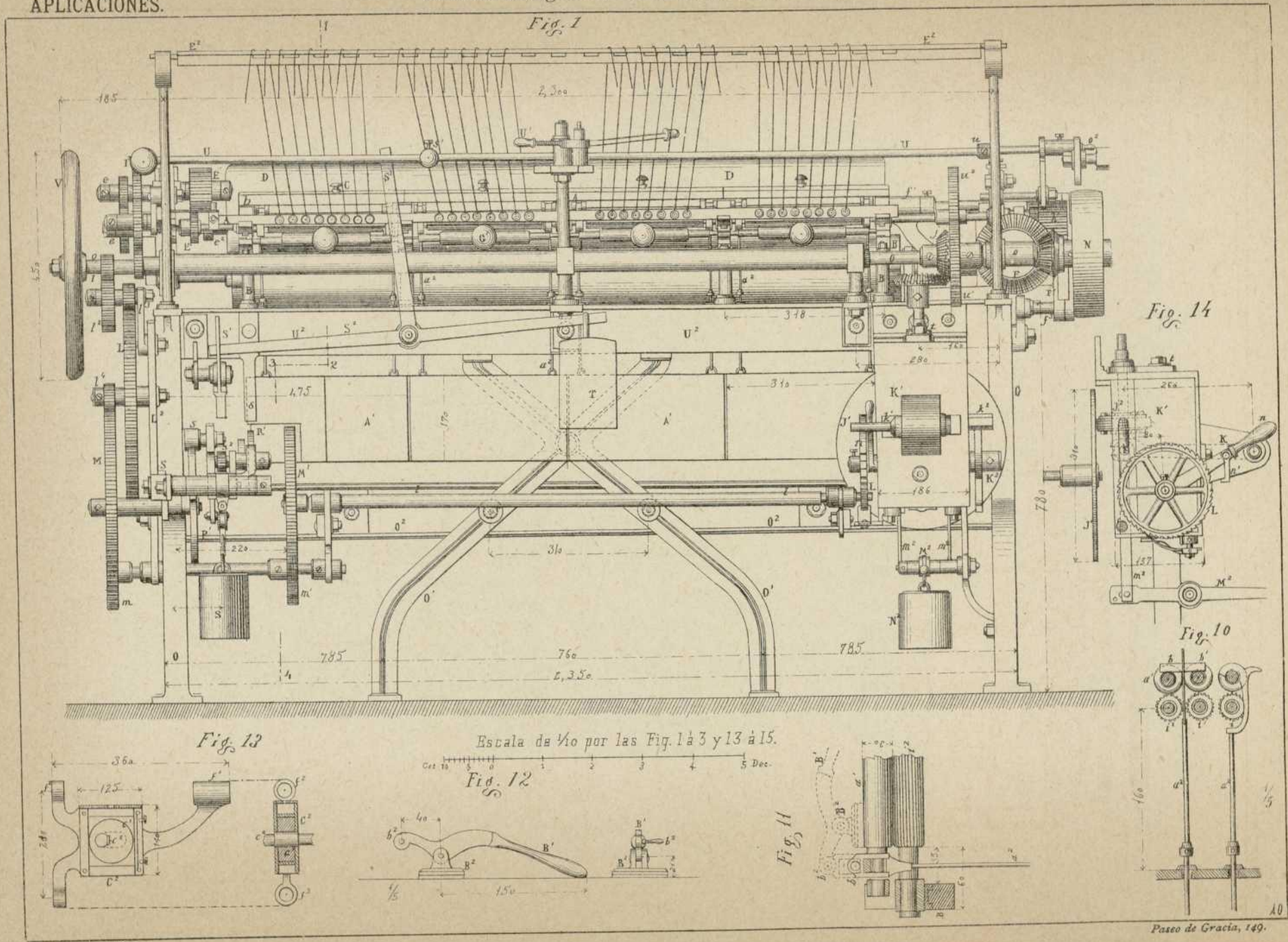


Fig. 3





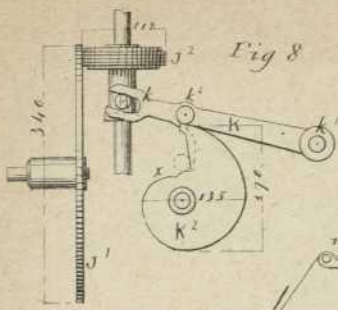
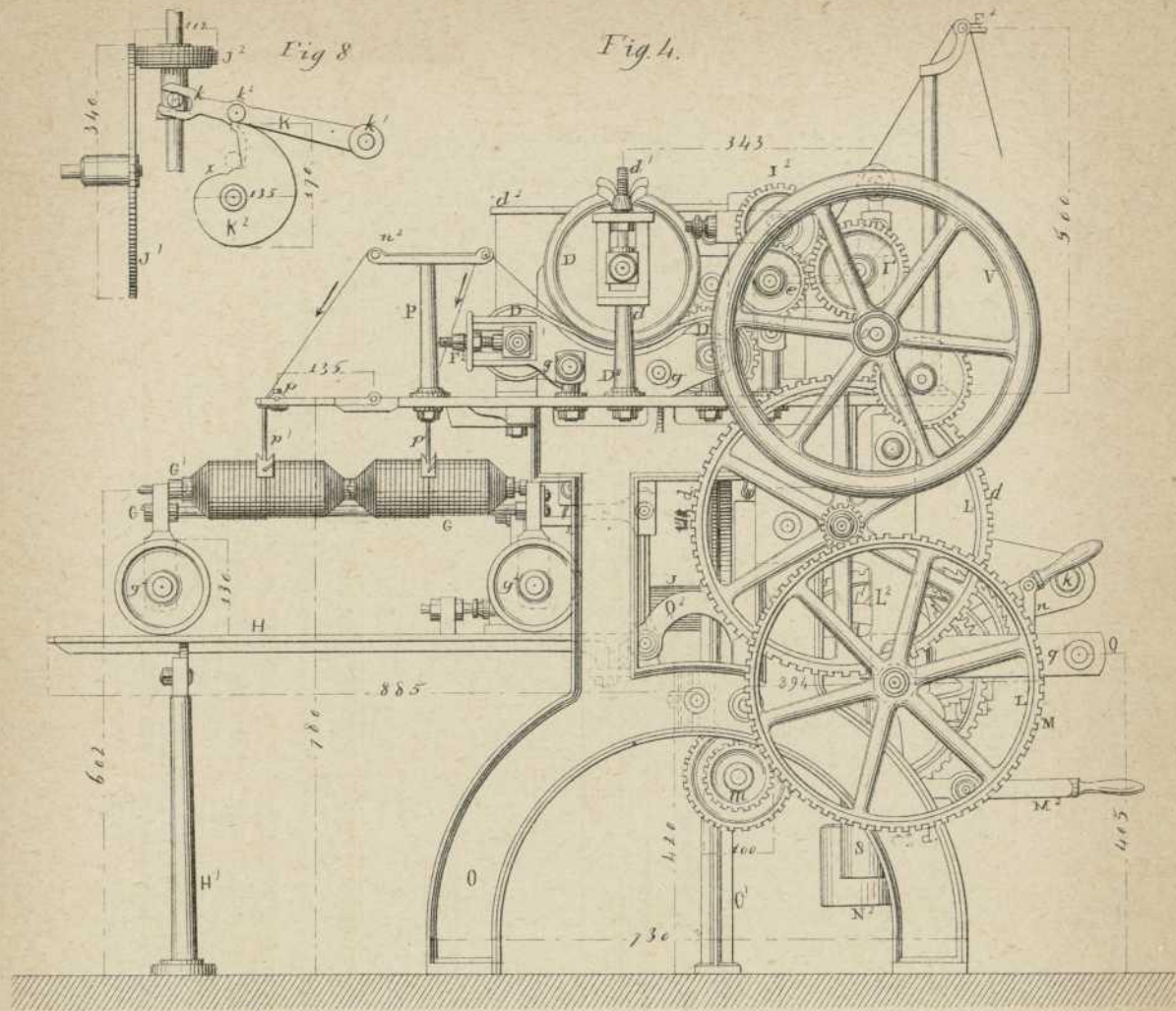
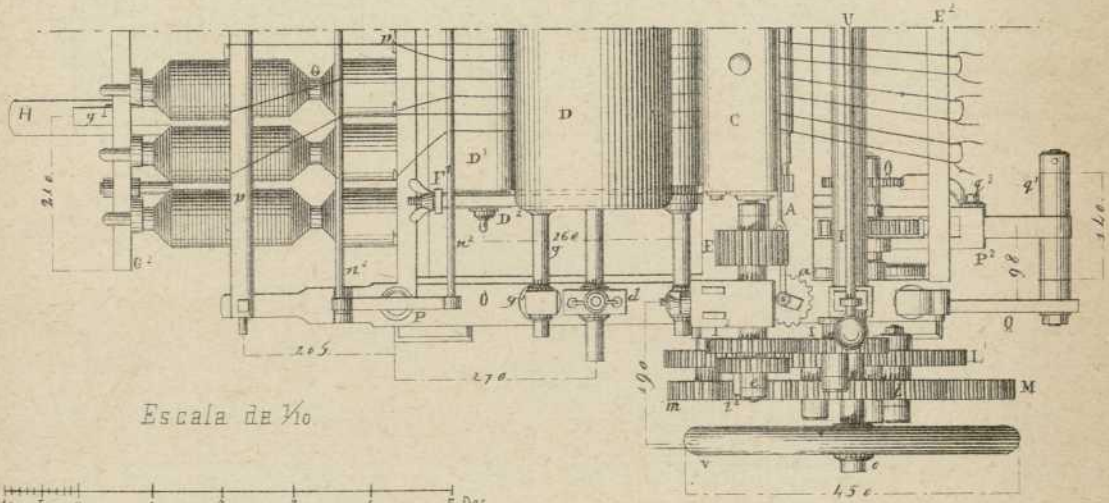


Fig. 4.

Fig. 8.

Fig. 6.



Escala de 1/10

Carta 5 0 1 2 3 4 5 Dec.

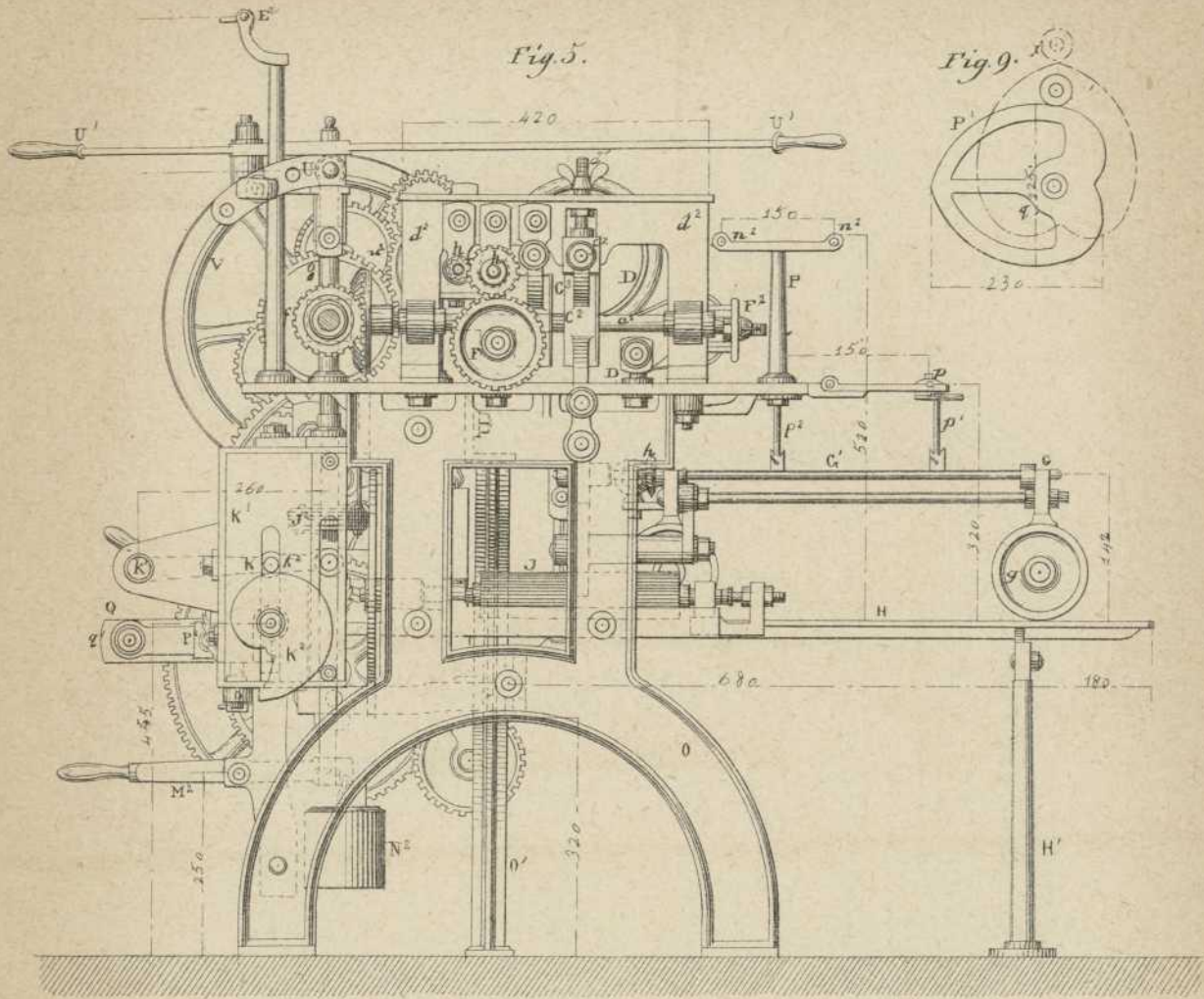
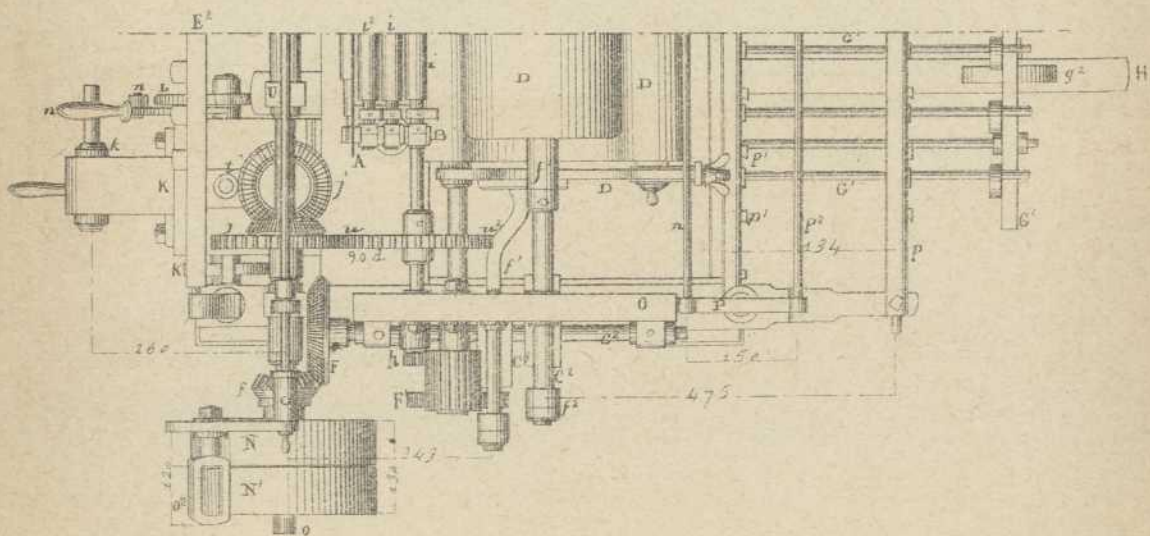
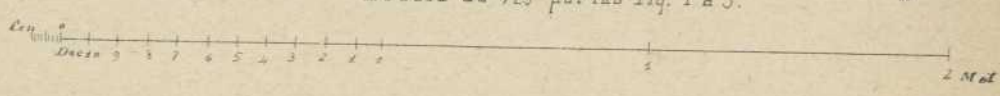
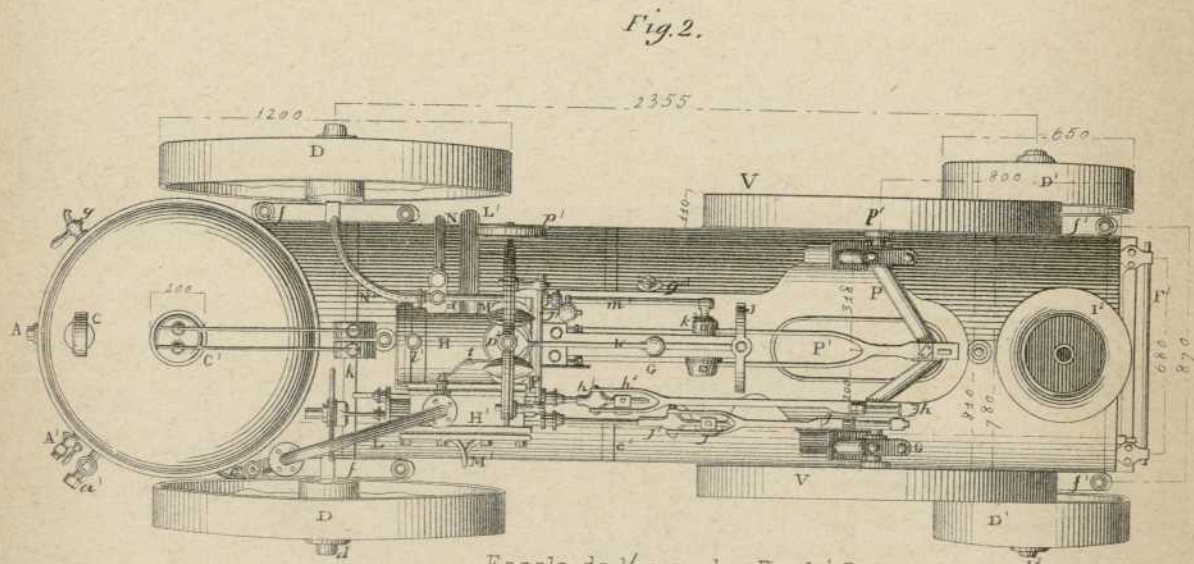
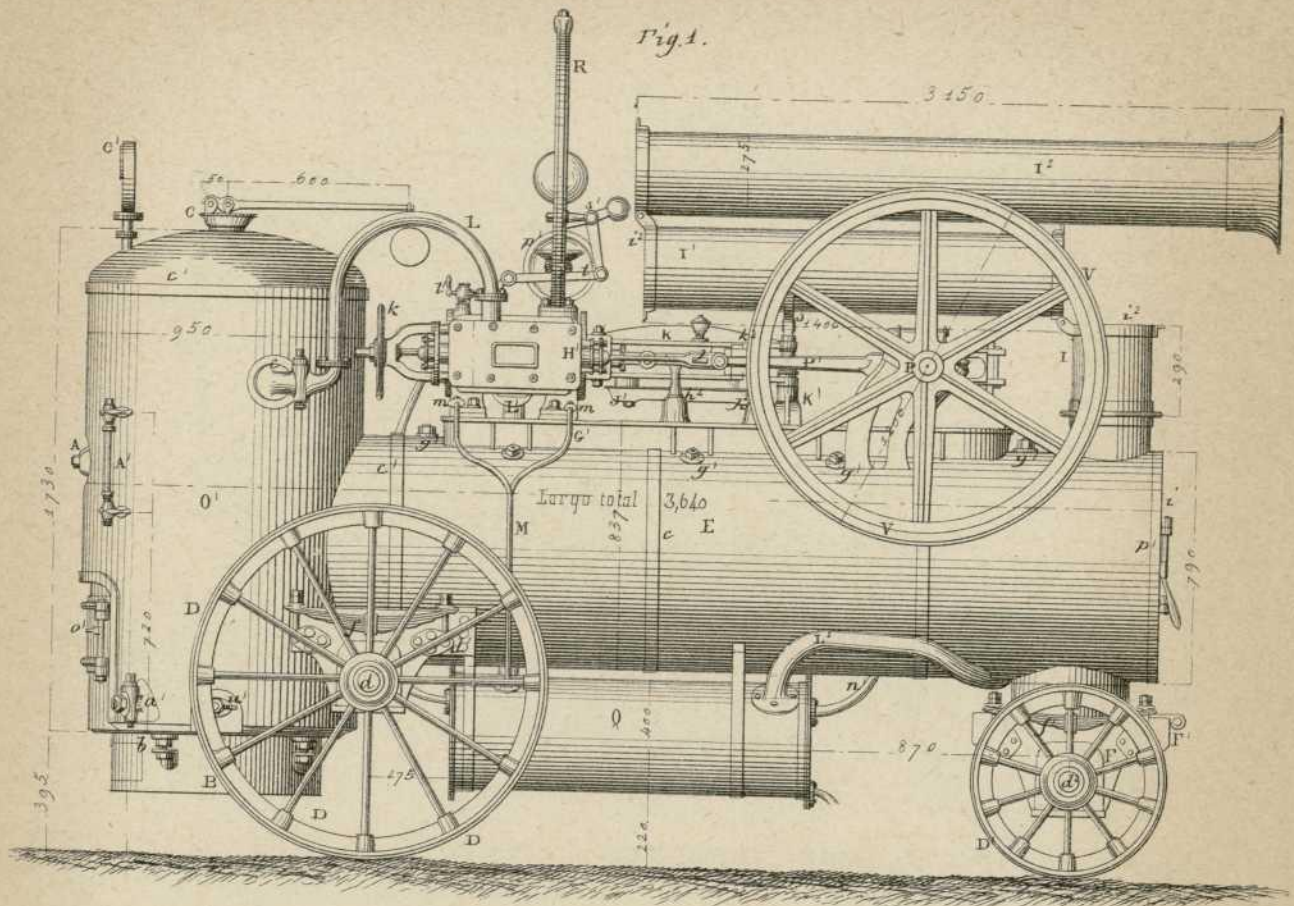
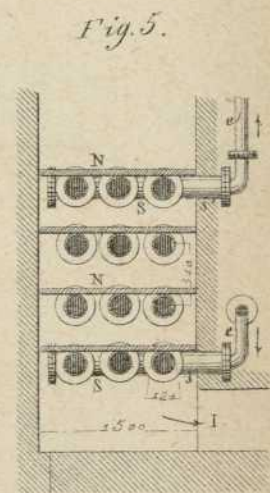
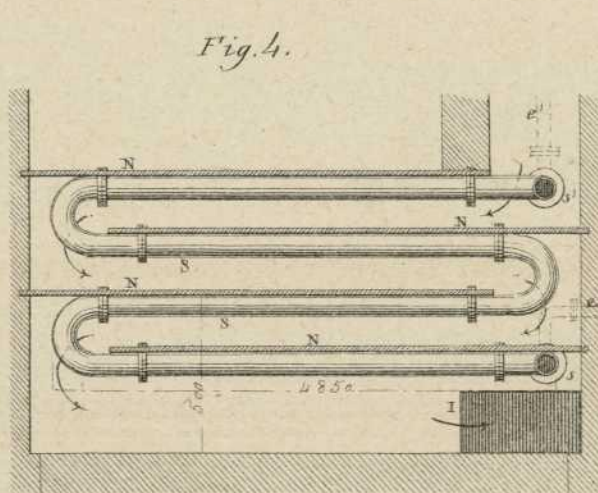
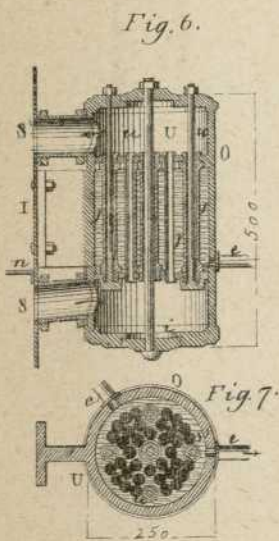
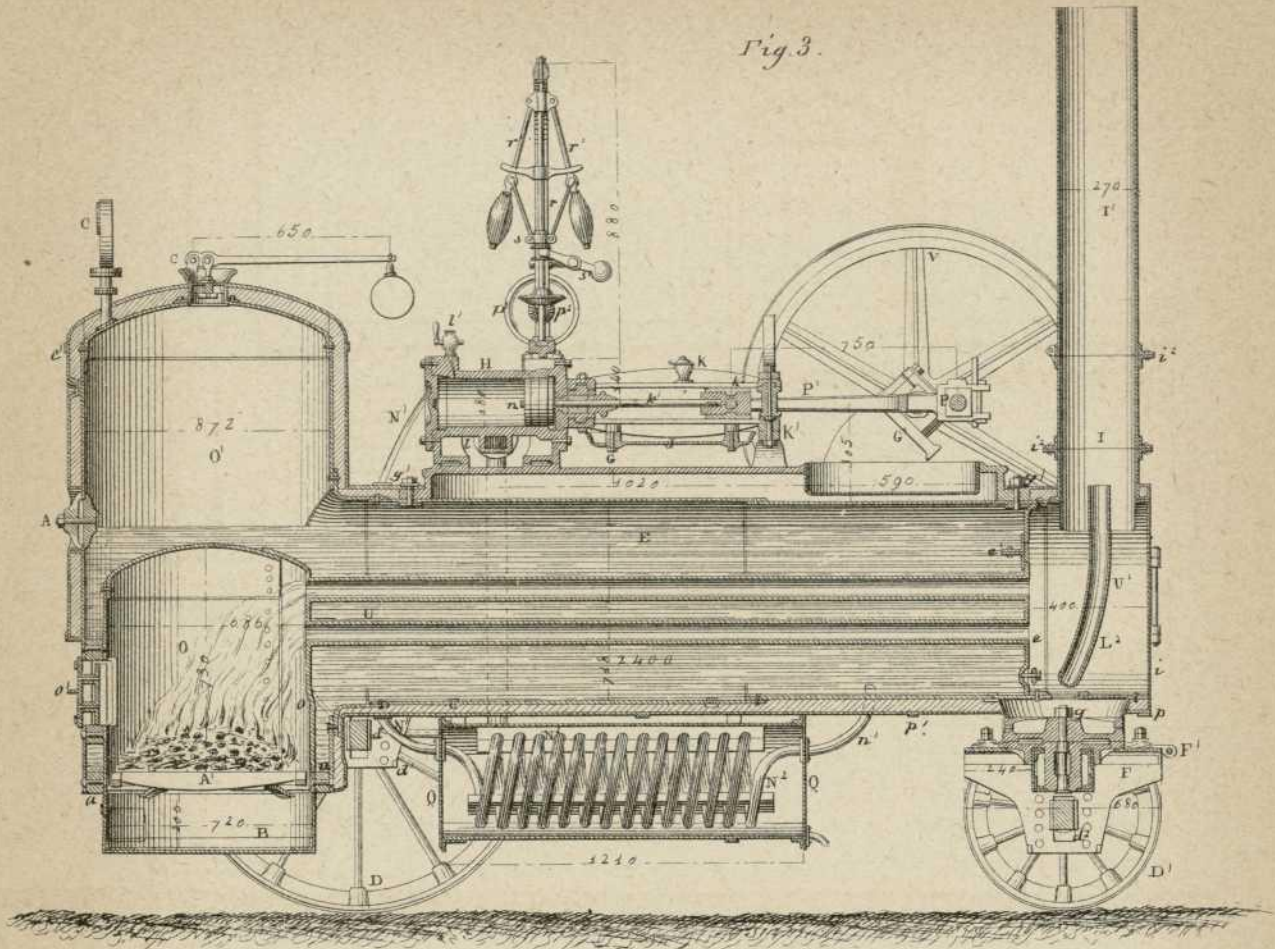


Fig. 7.



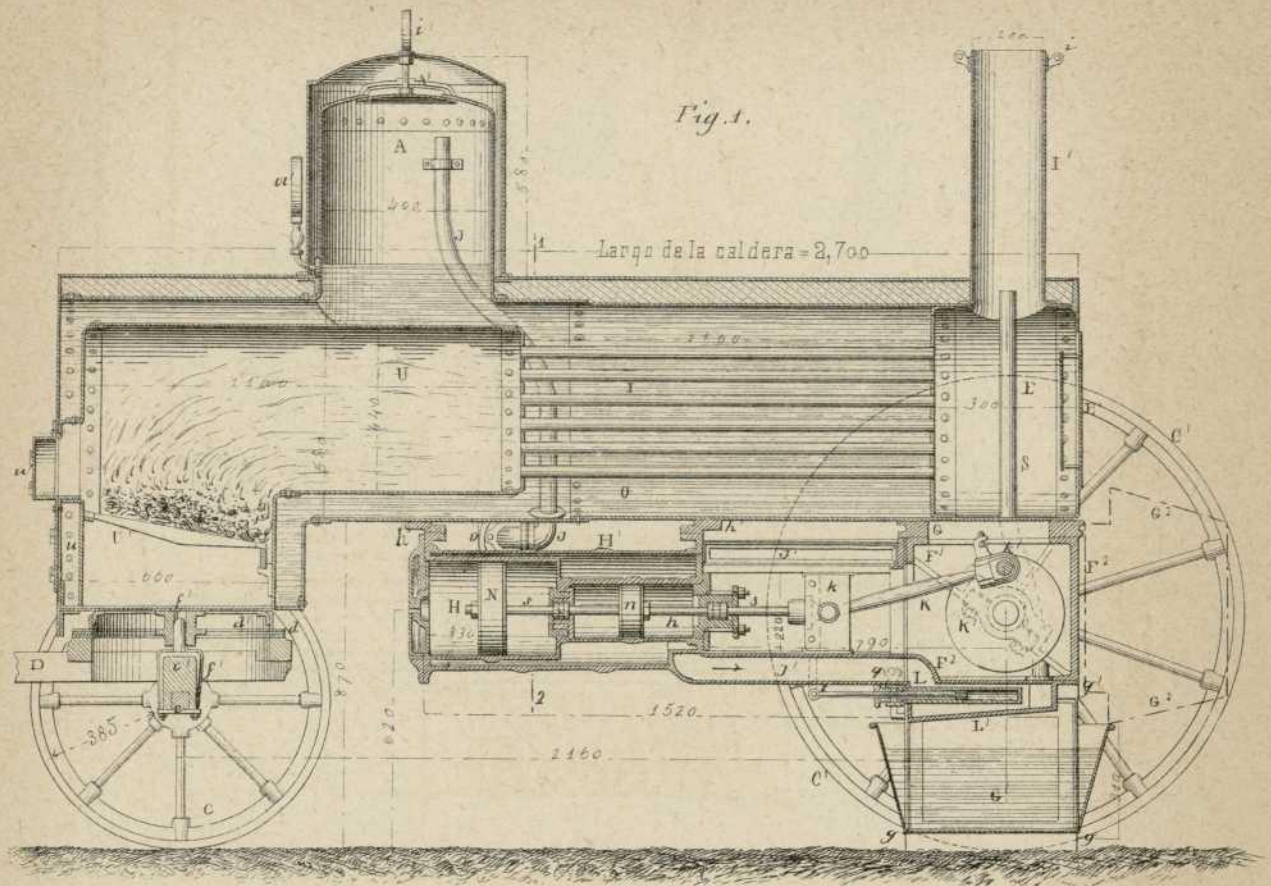


Logo of the publisher.



Escala de 1/15 por las Fig. 6 y 7.

Escala de 1/40 por las Fig. 4 y 5.



Escala de 1/20 por las Fig. 1 á 8.

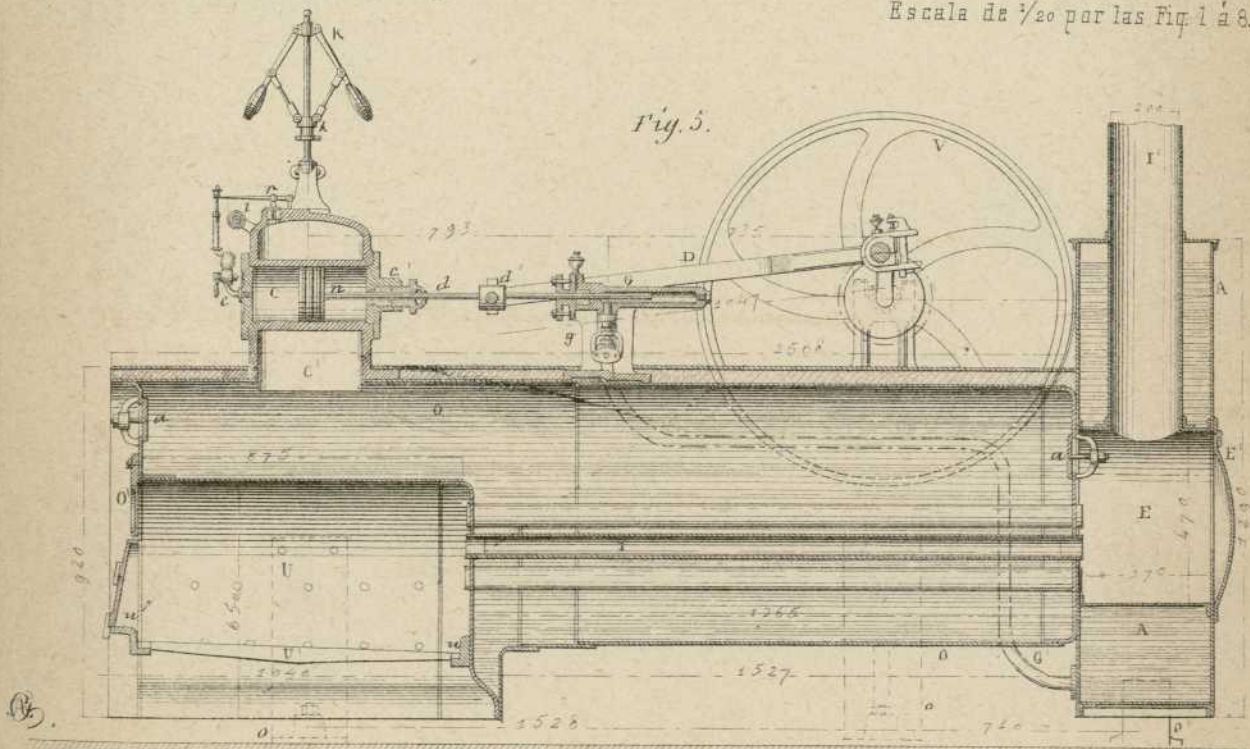


Fig. 2.

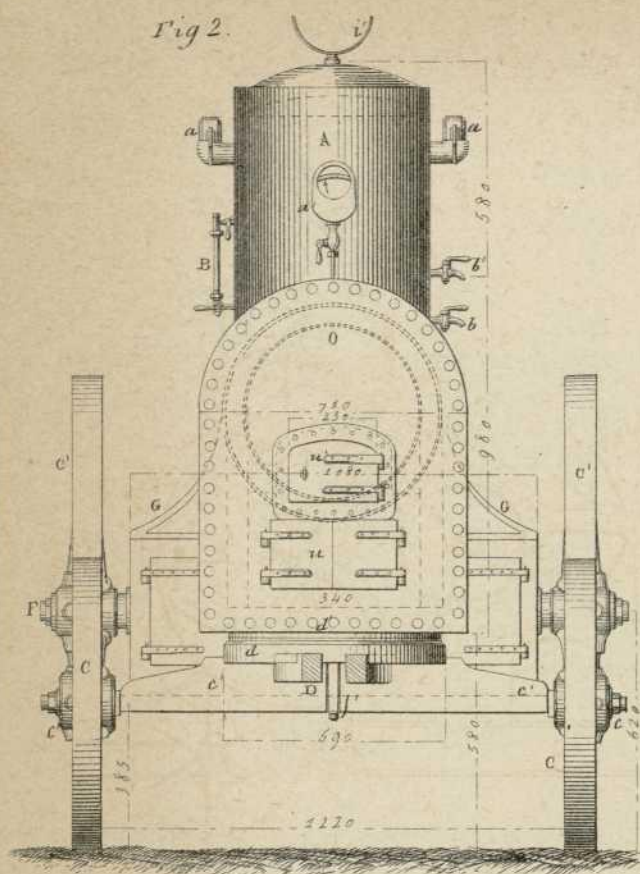


Fig. 4.

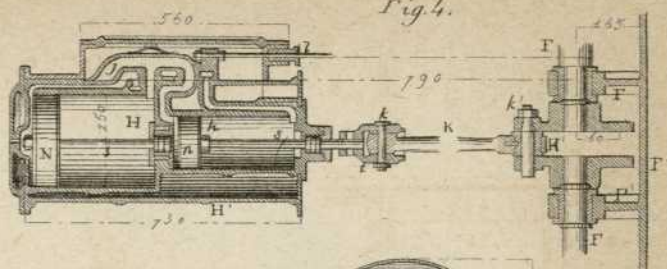


Fig. 3.

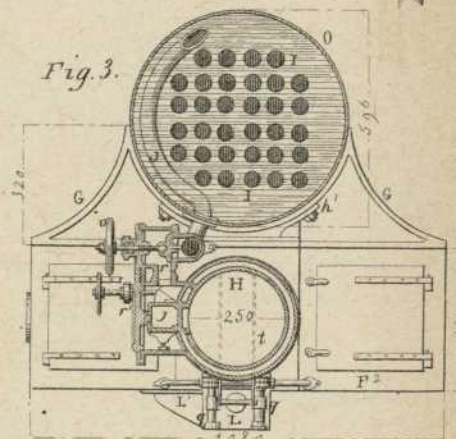
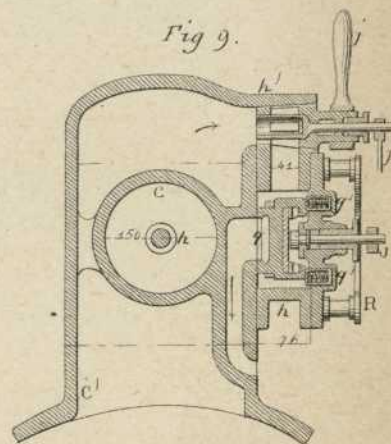


Fig. 9.



Escala de 1/10

Fig. 6.

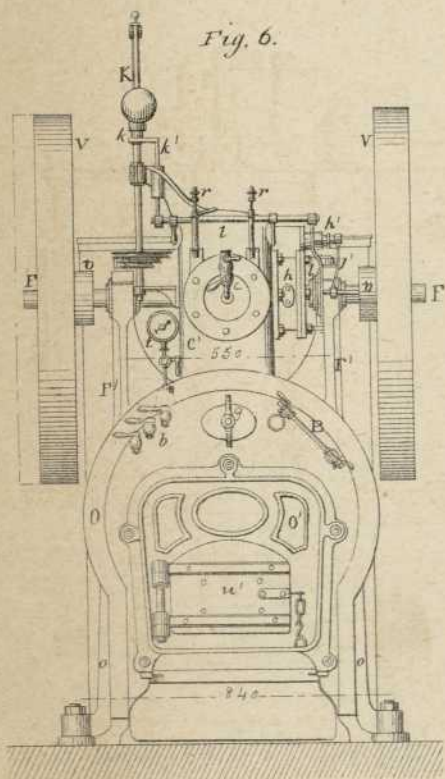


Fig. 8.

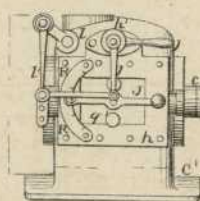


Fig. 7.

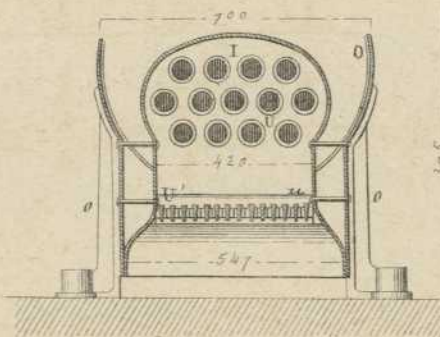
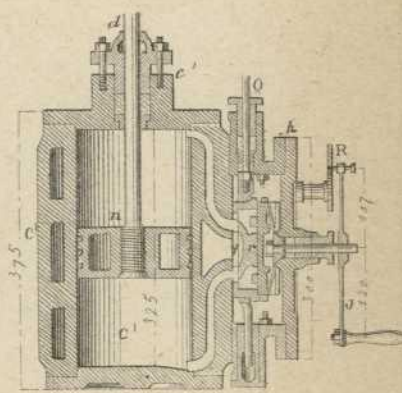
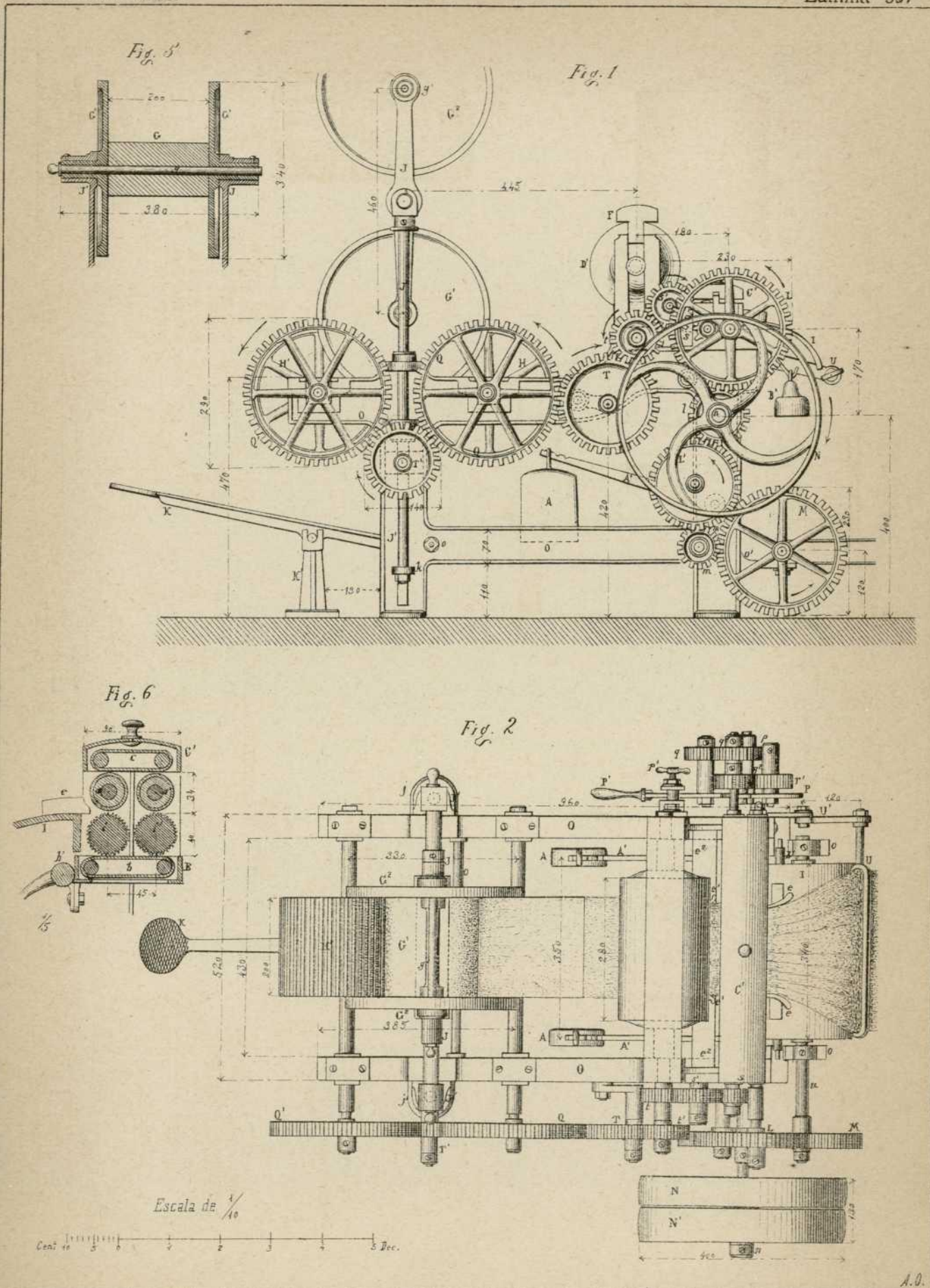


Fig. 10.





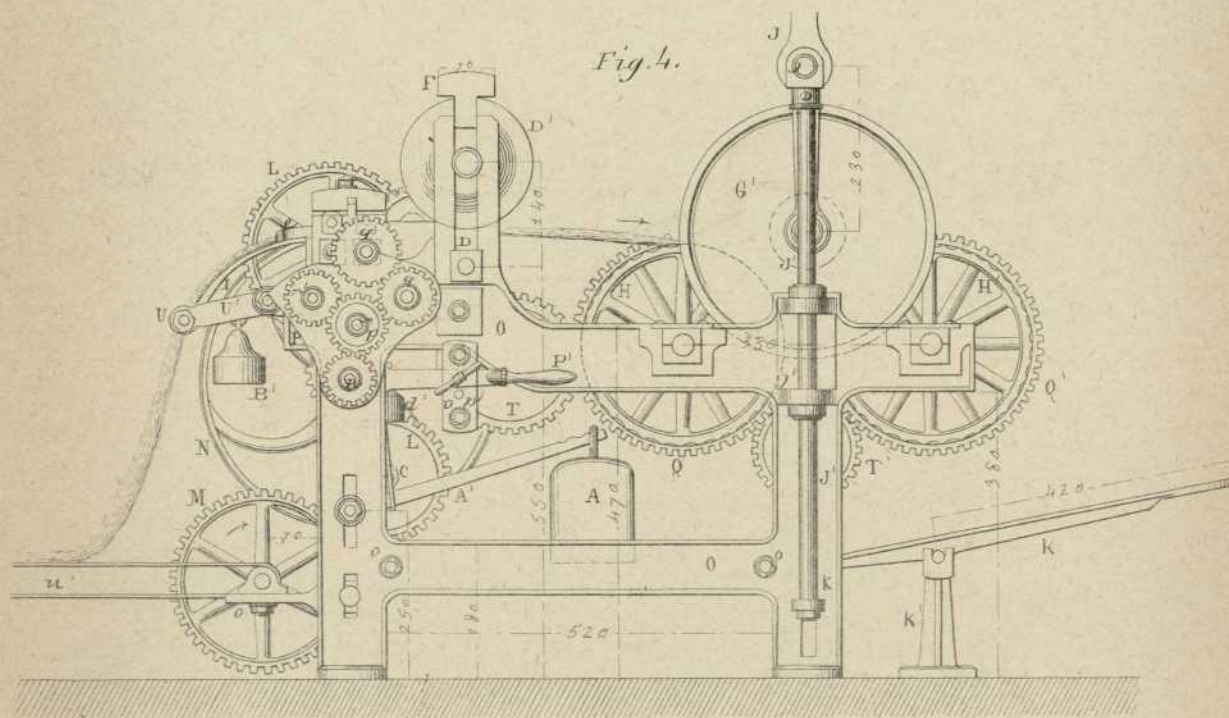
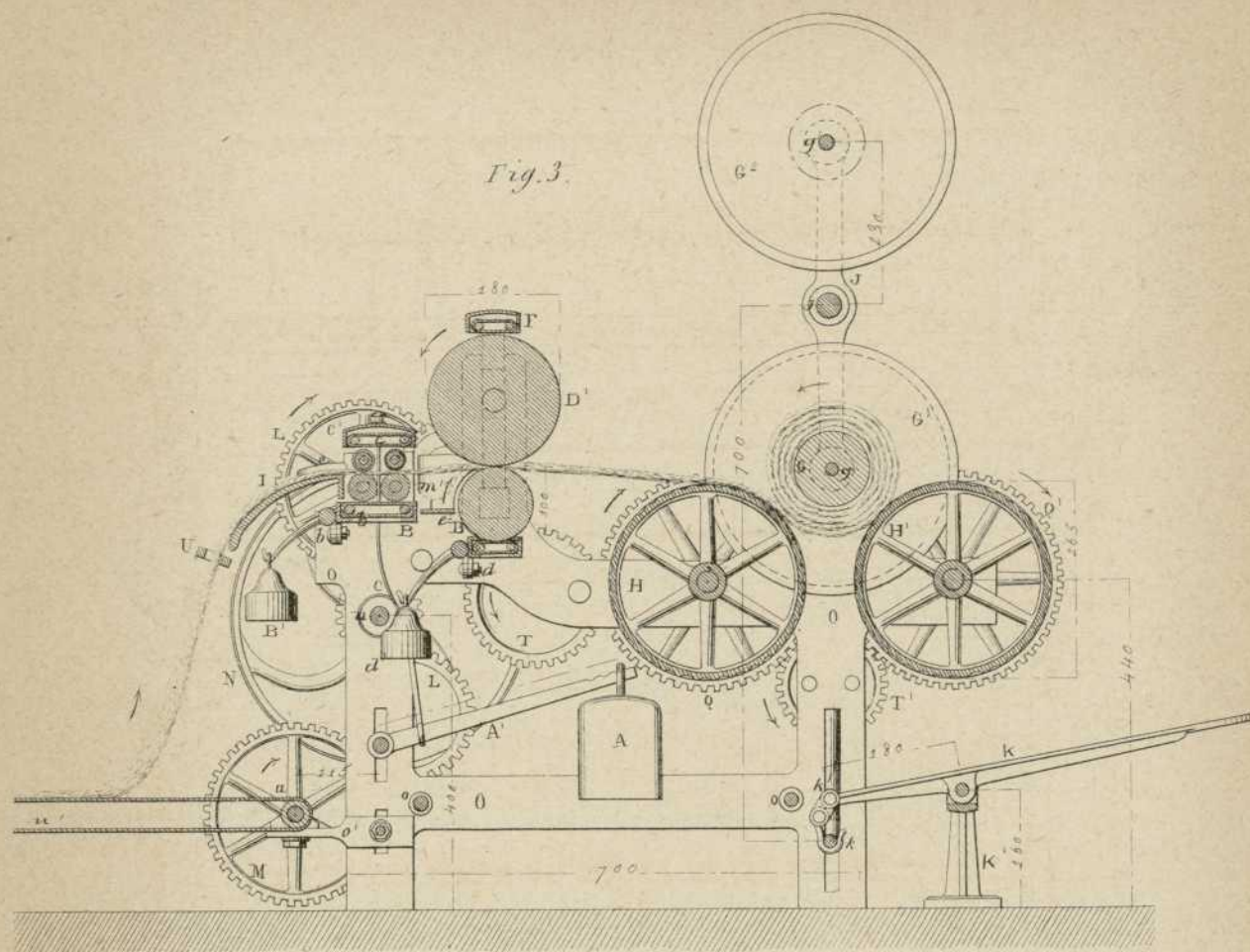


Fig. 1

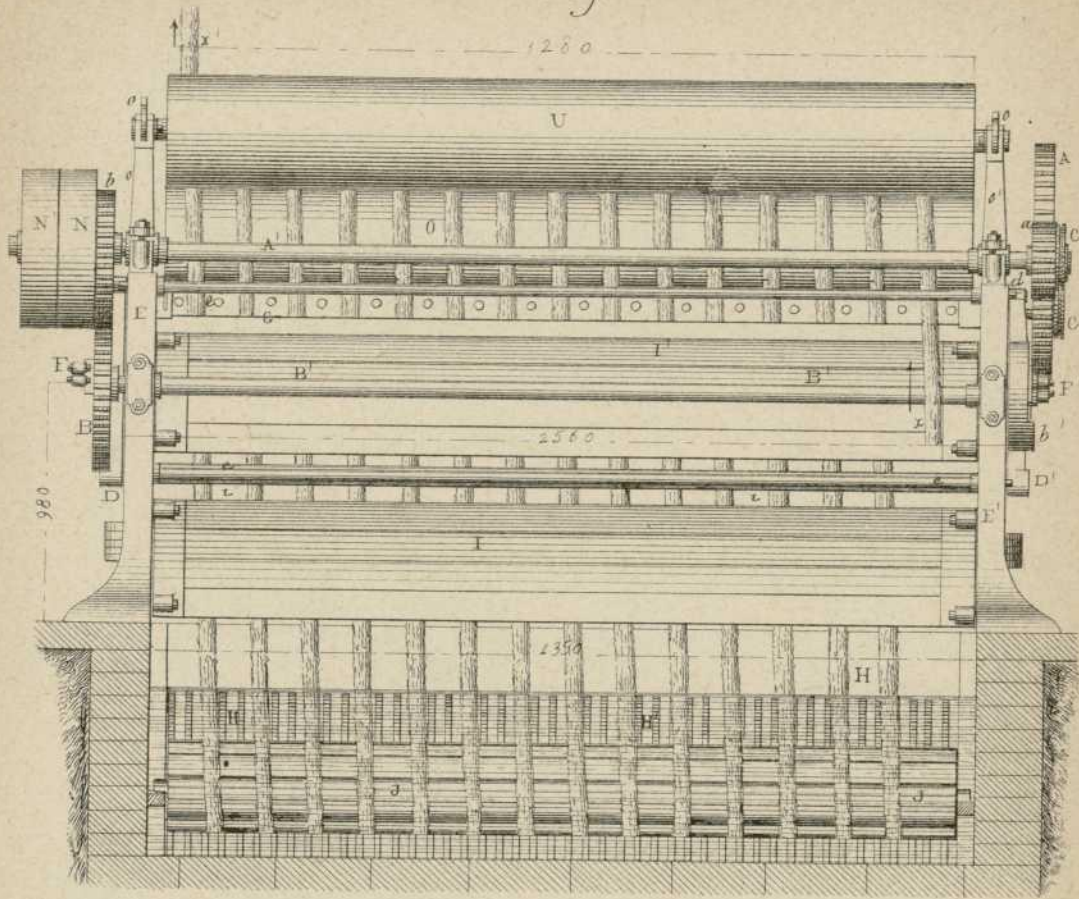
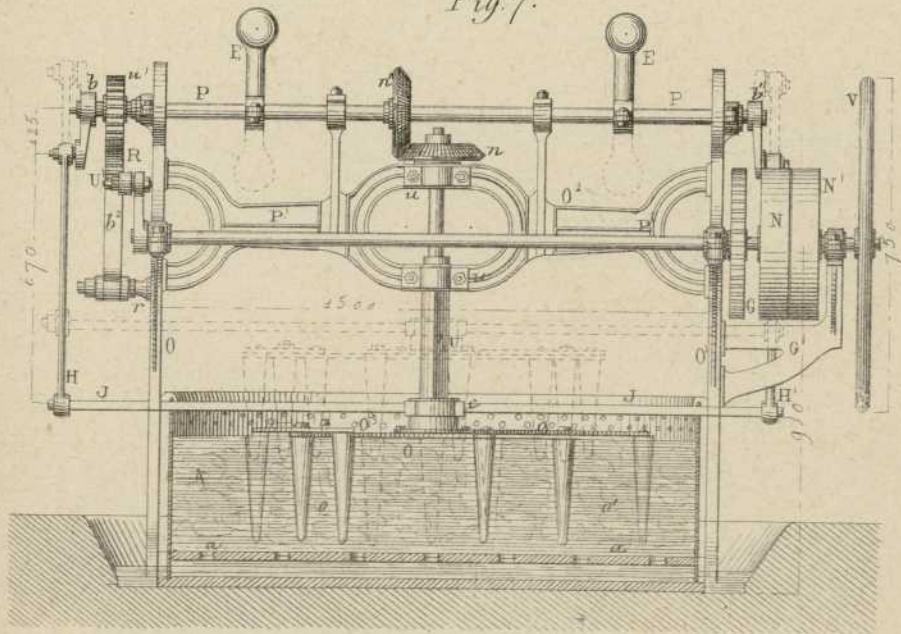


Fig. 7.



AB.

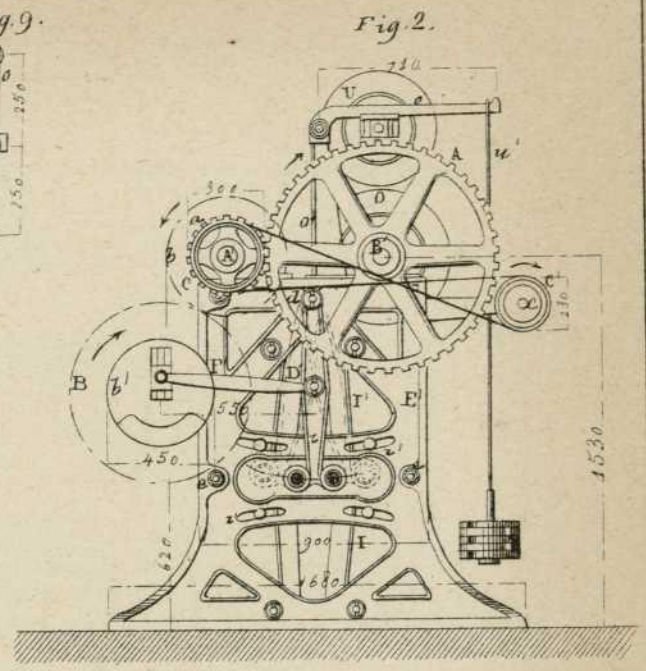
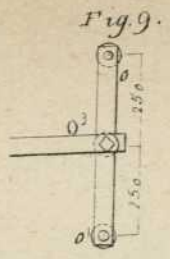
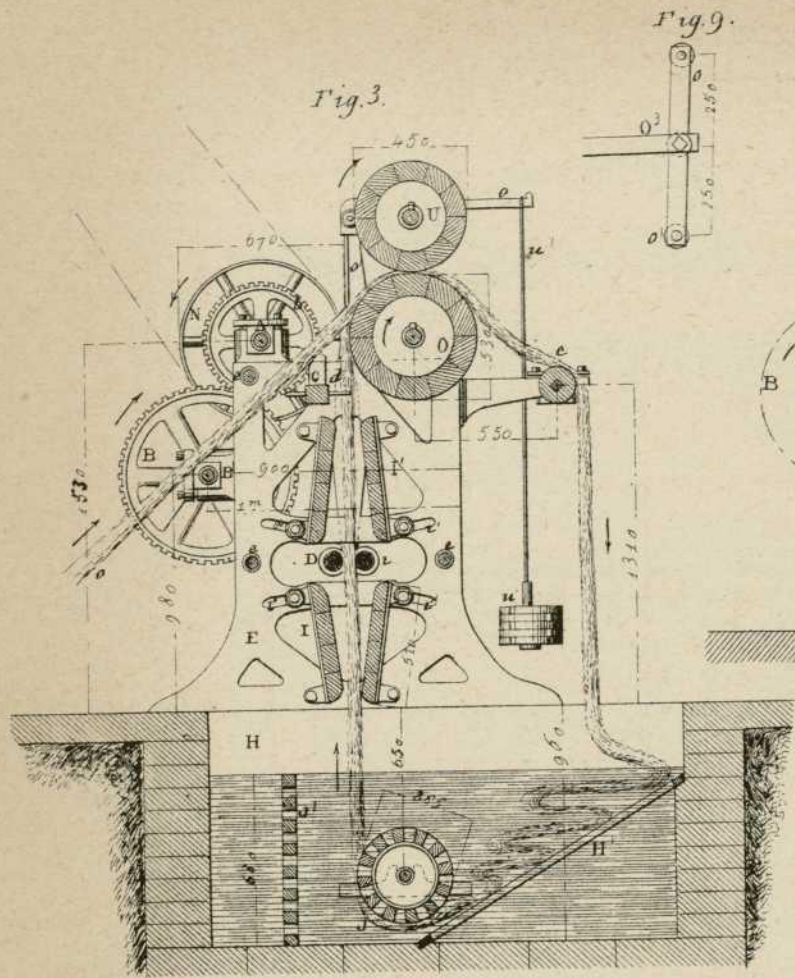
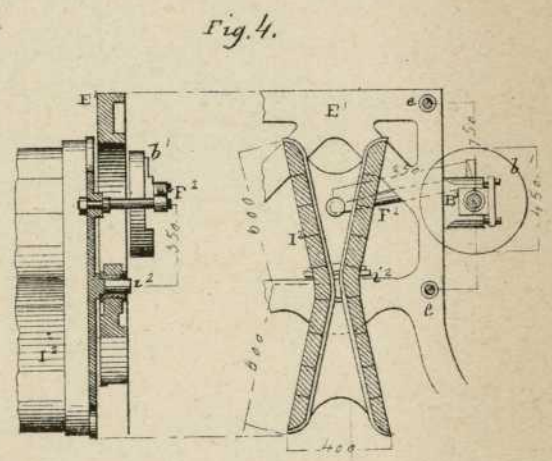
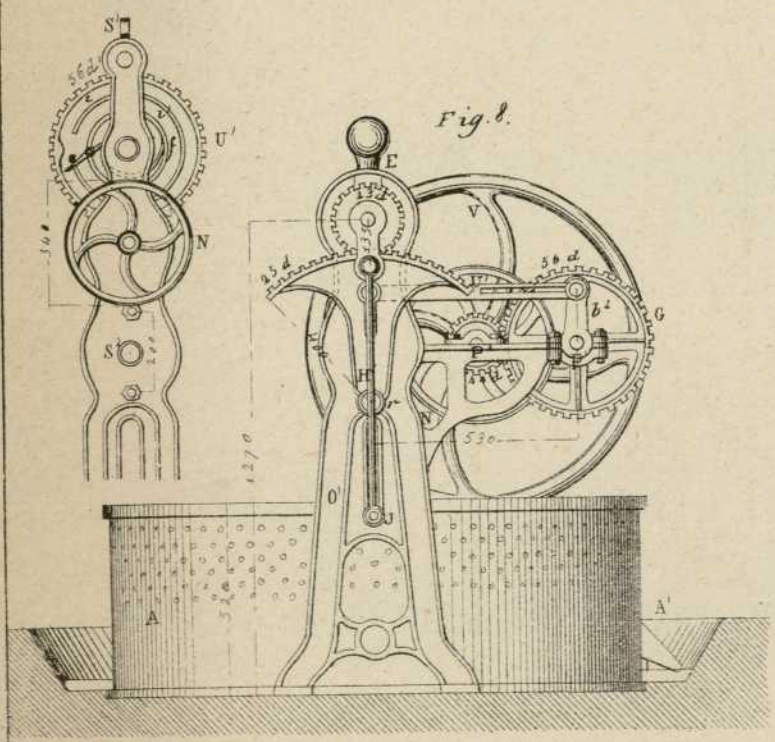


Fig. 6.

Escala de 1/20 por las Fig. 5 á 9.



Escala de 1/30 por las Fig. 1 á 4.

Fig. 5.

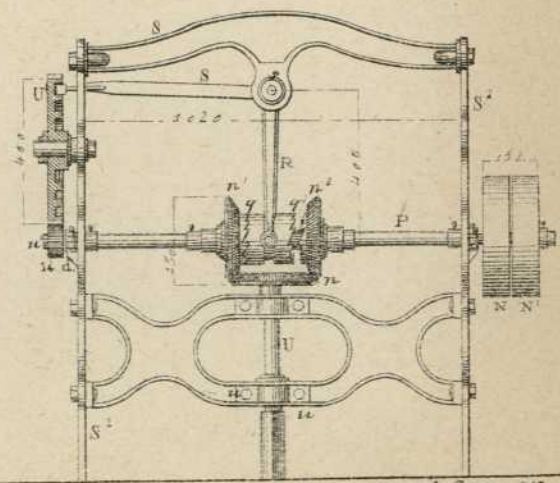
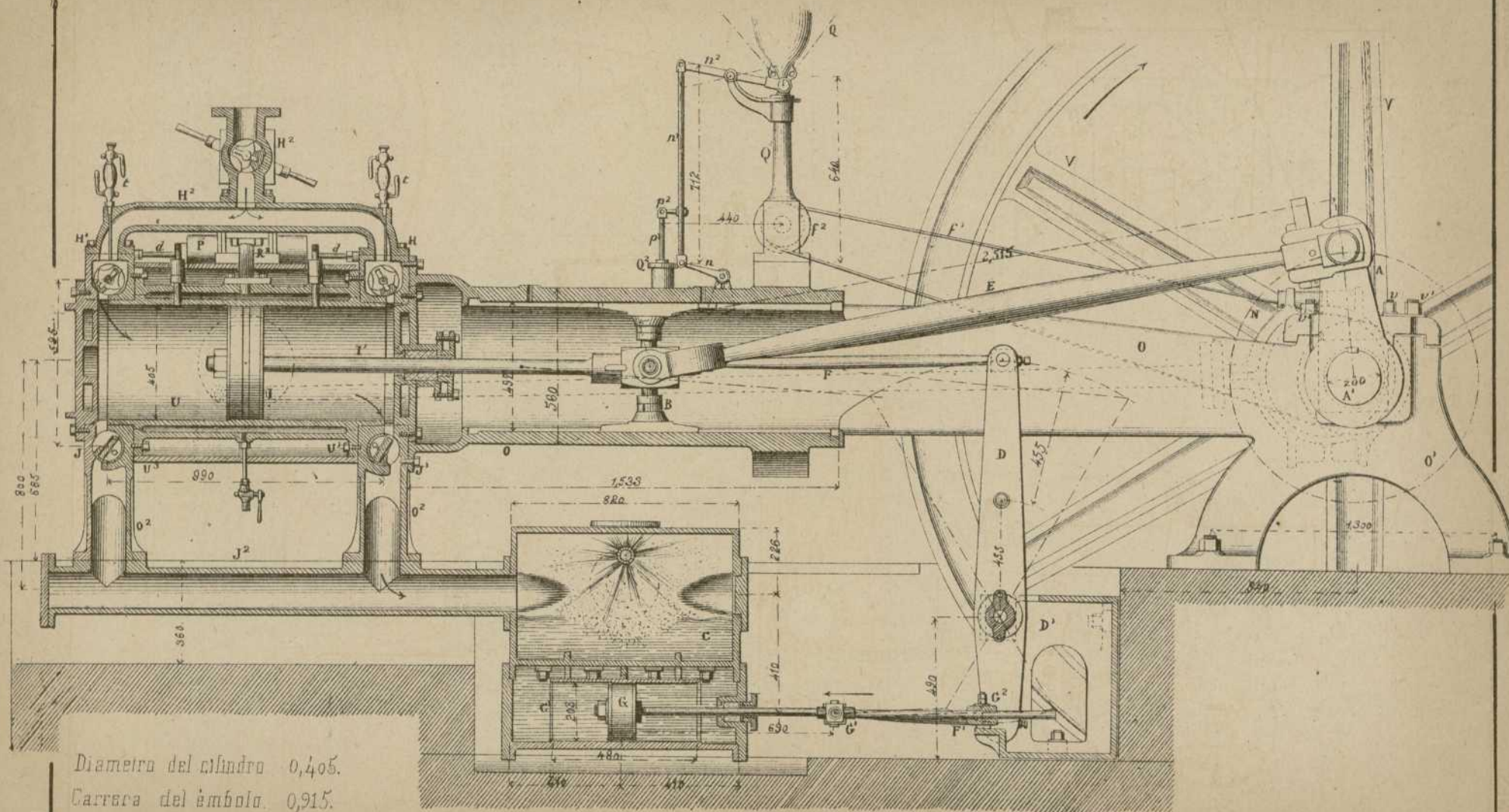
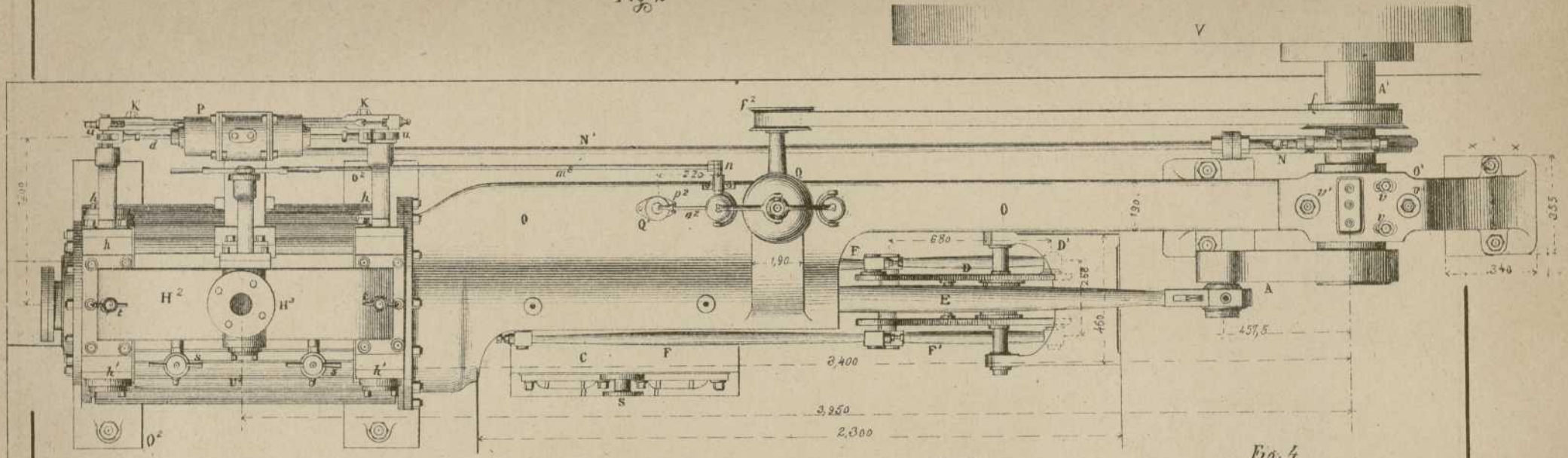


Fig. 1



Diametro del cilindro 0,405.
Carrera del émbolo 0,915.

Fig. 2



Escala de 1/20

Fig. 3

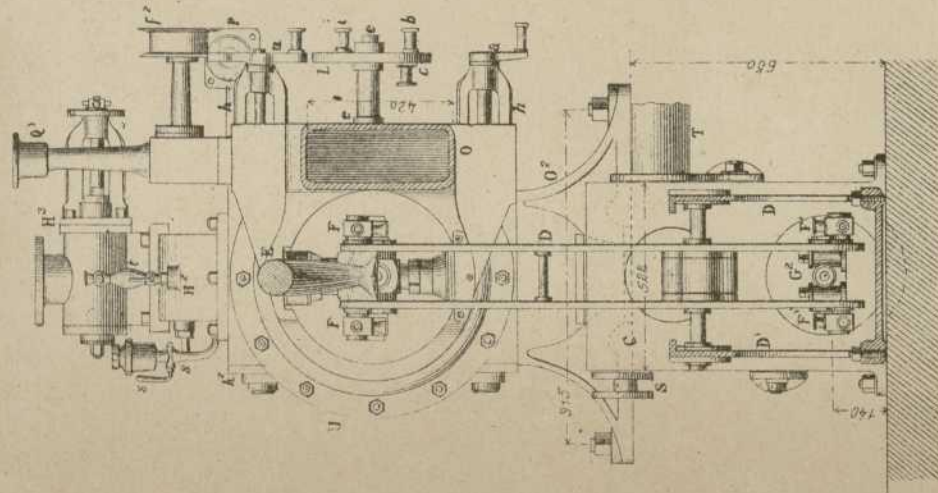


Fig. 5

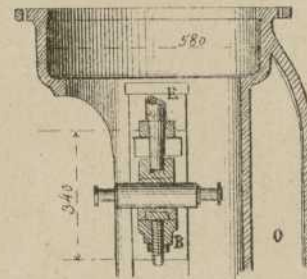


Fig. 4

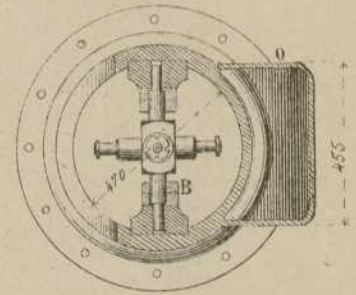


Fig. 16

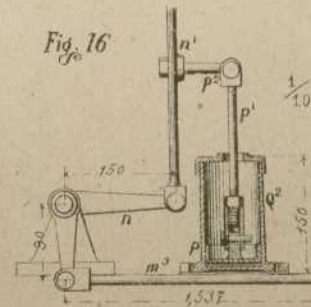


Fig. 6.

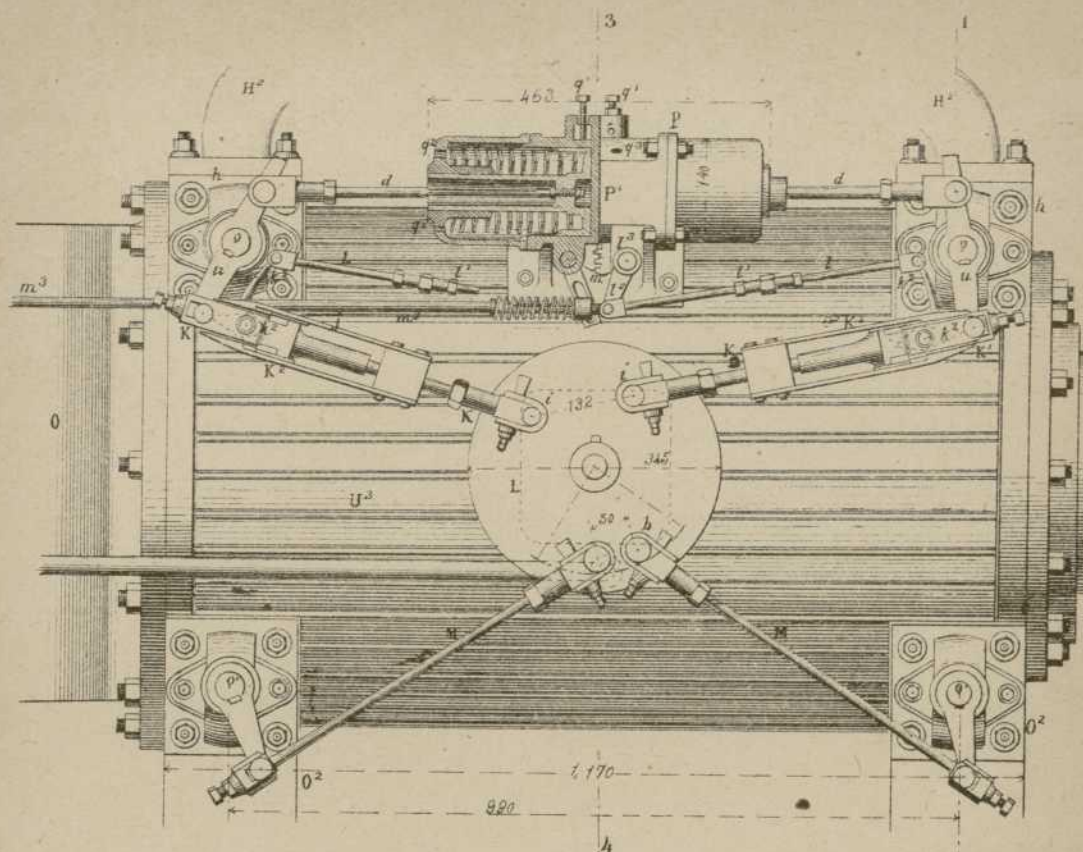
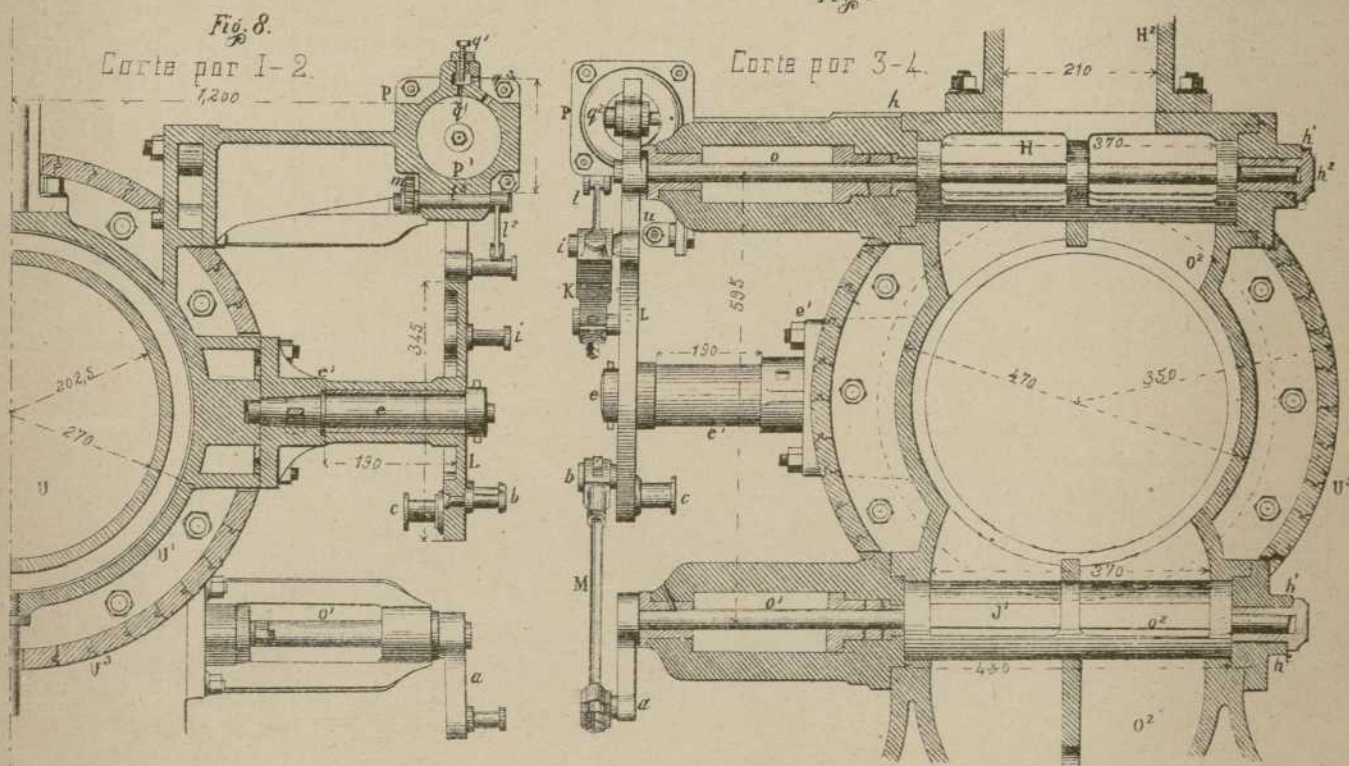
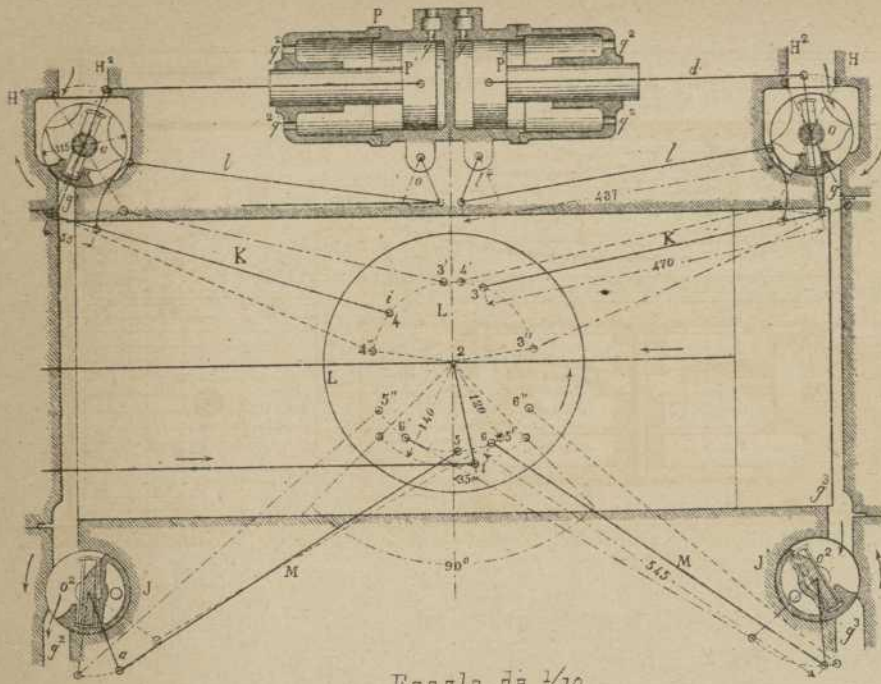


Fig. 7.





Escala de 1/10

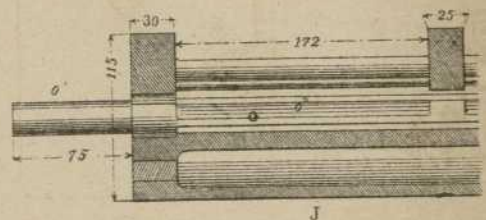
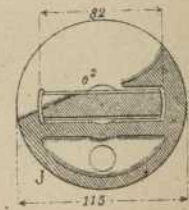
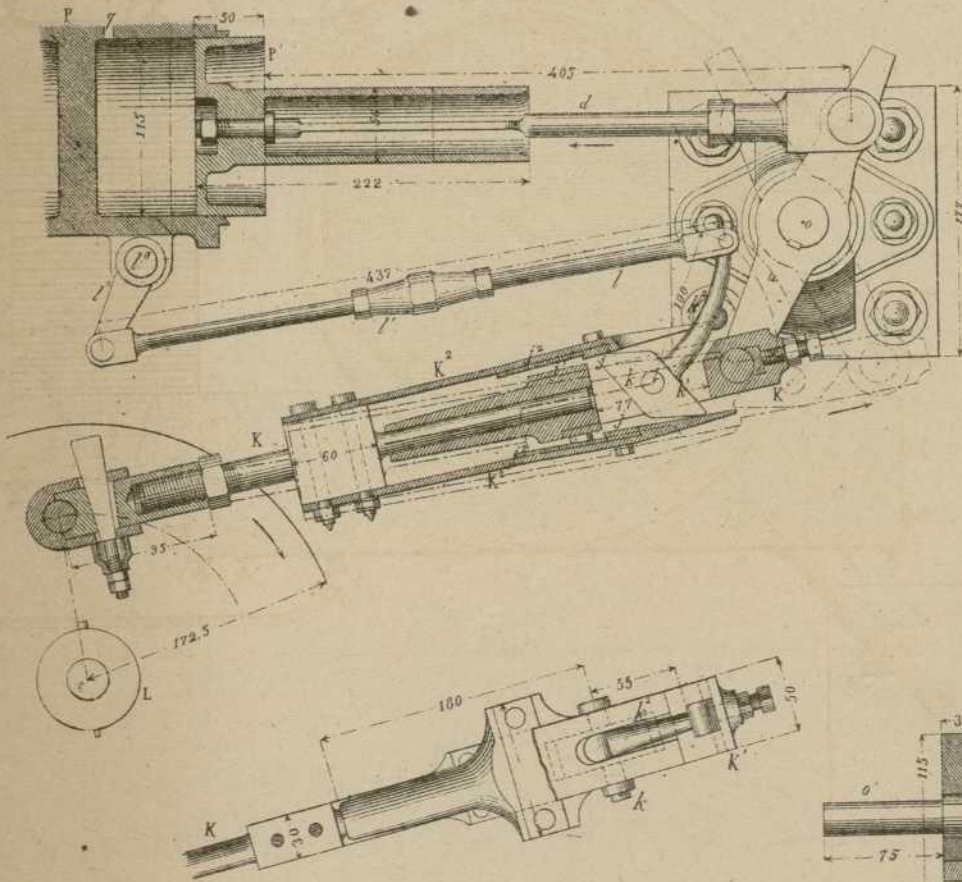
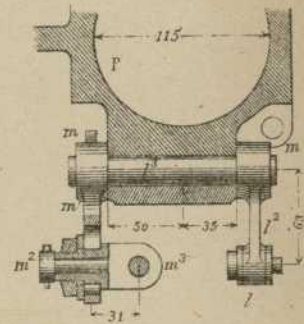
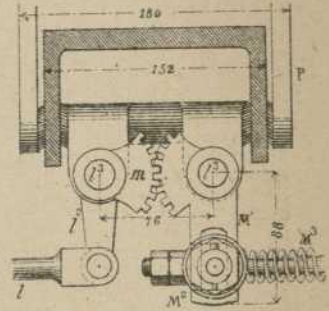
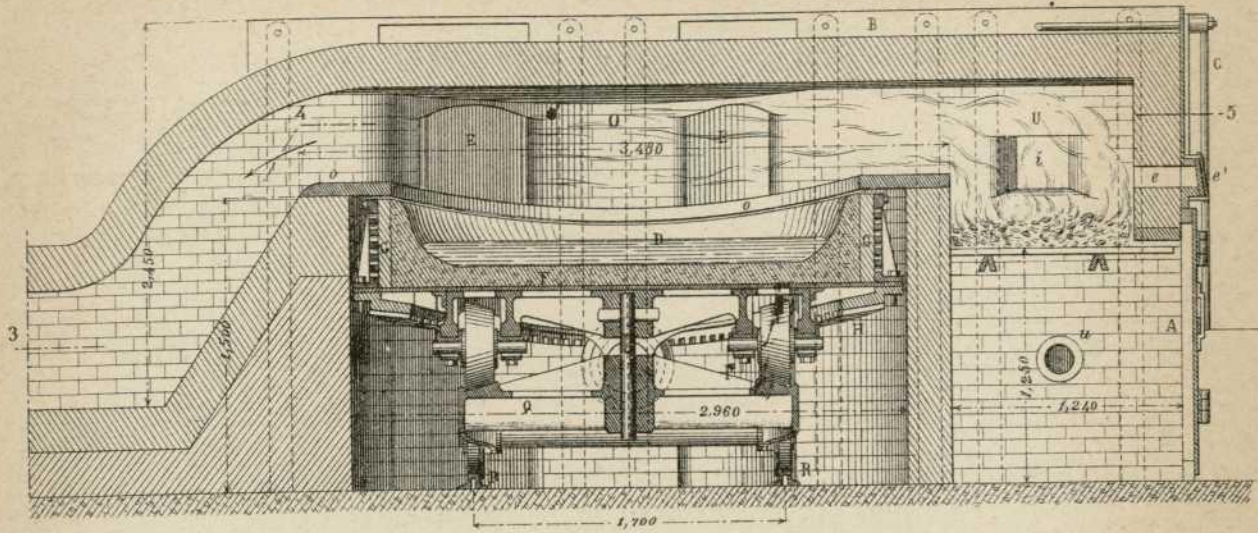
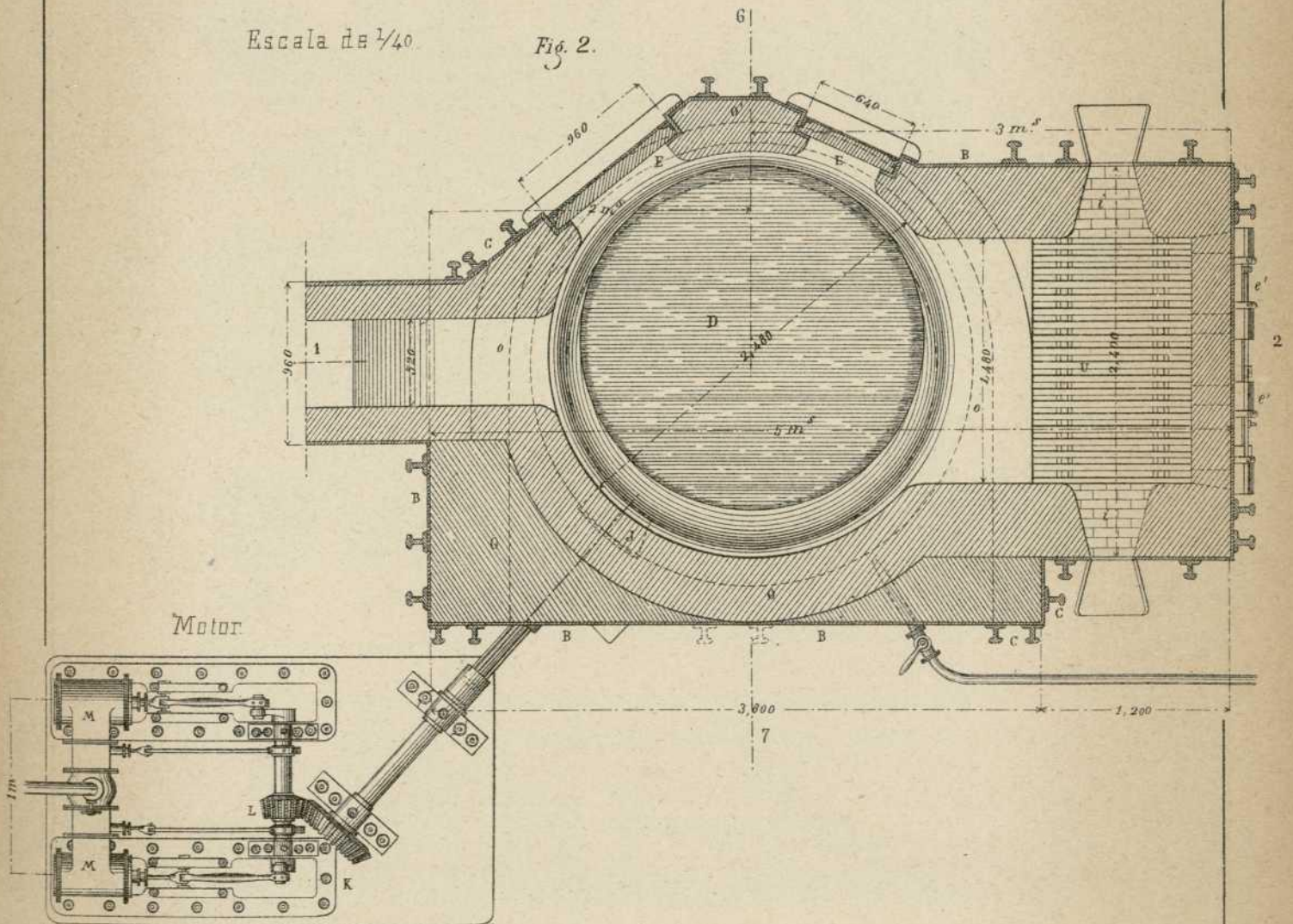


Fig. 1.



Escala de 1/40.

Fig. 2.



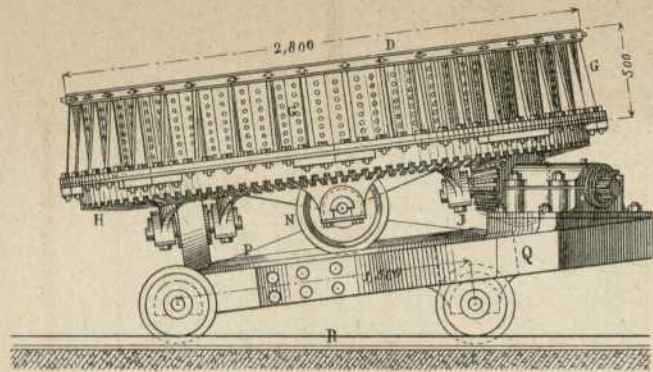
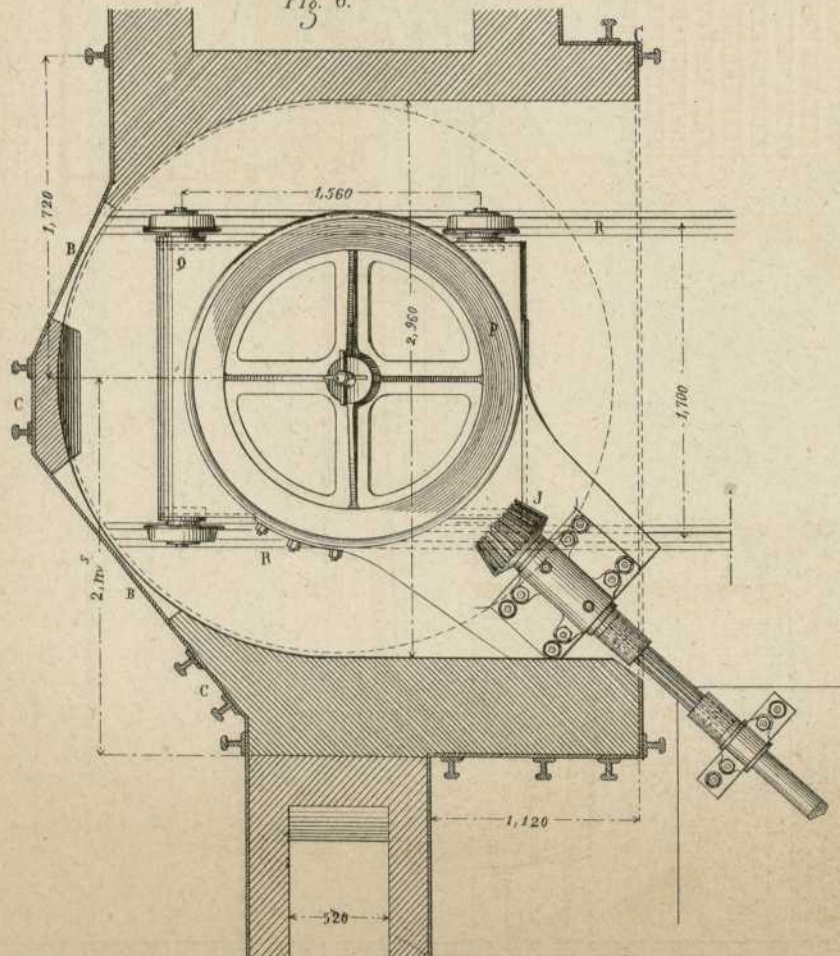


Fig. 6.



8.

Fig. 3.

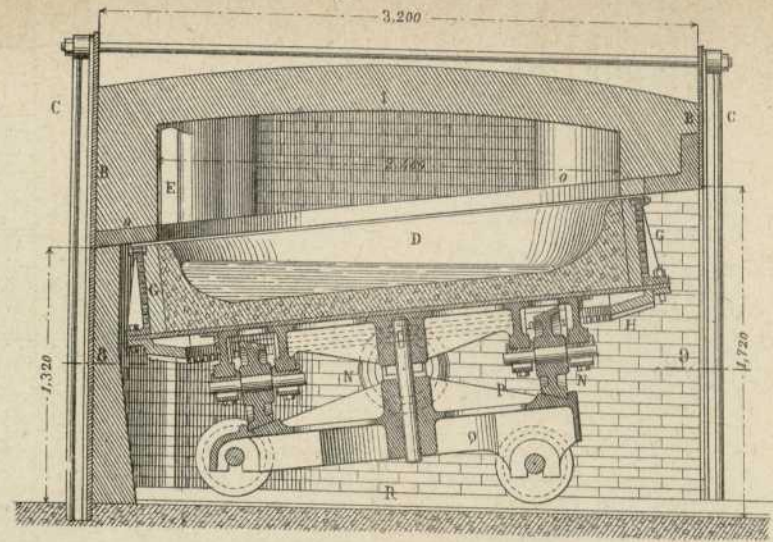
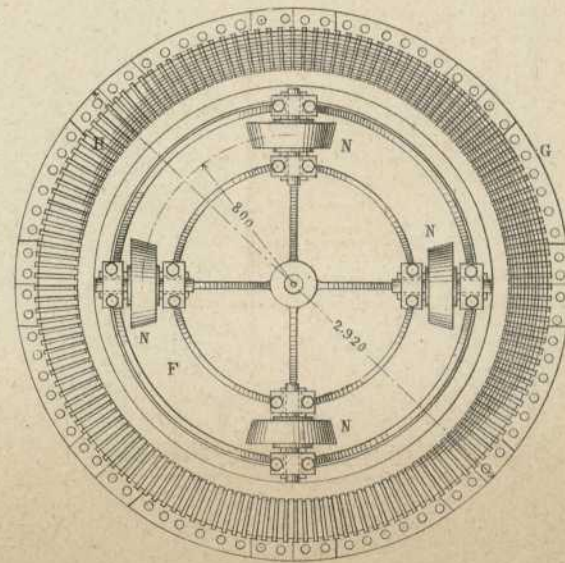


Fig. 5.



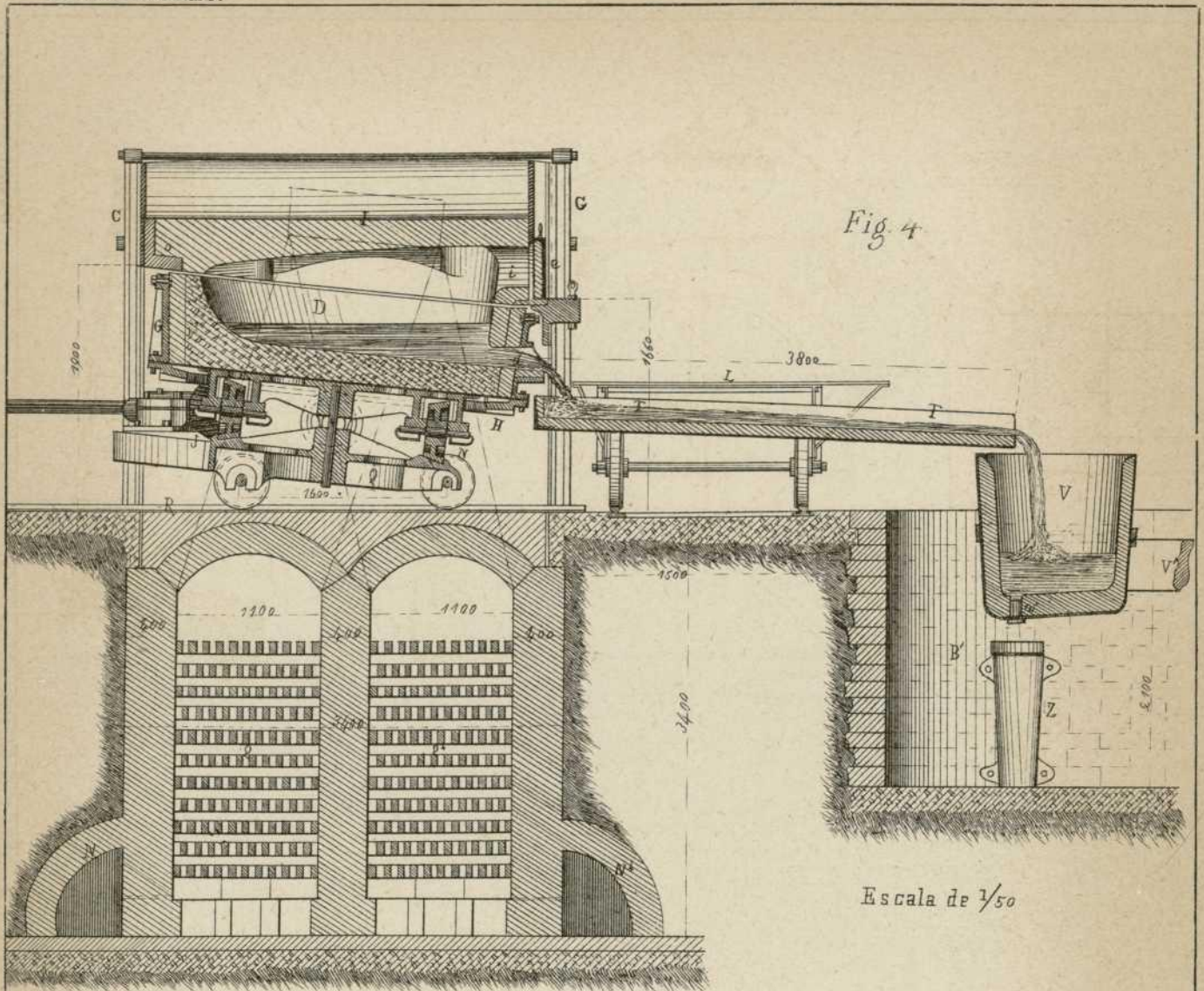


Fig. 4

Escala de 1/50

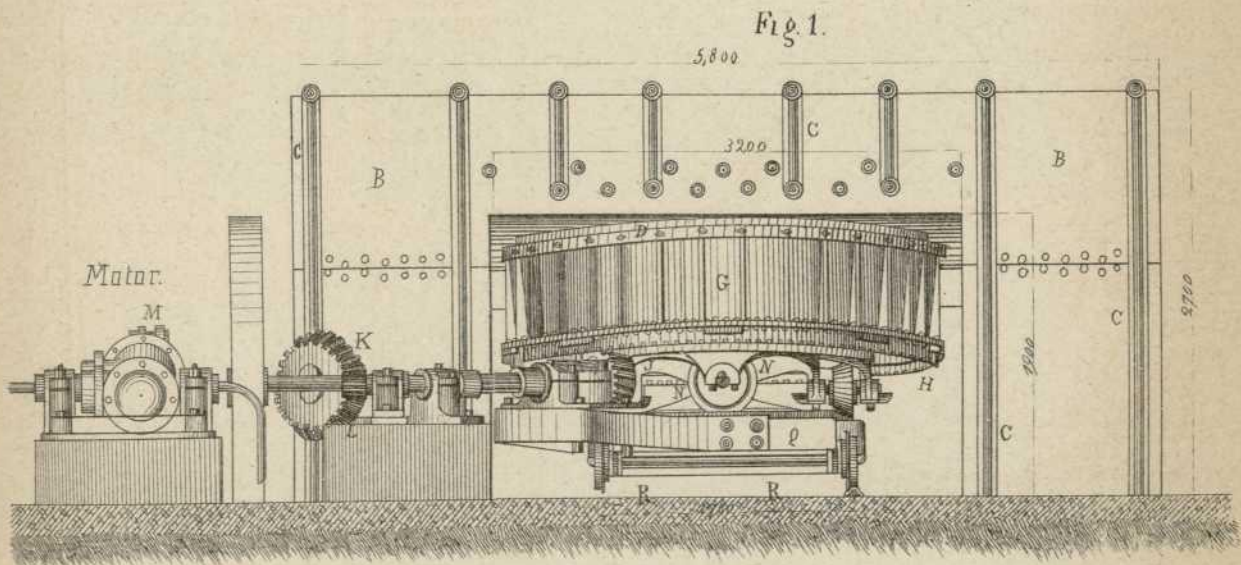


Fig. 1.

Fig. 2.

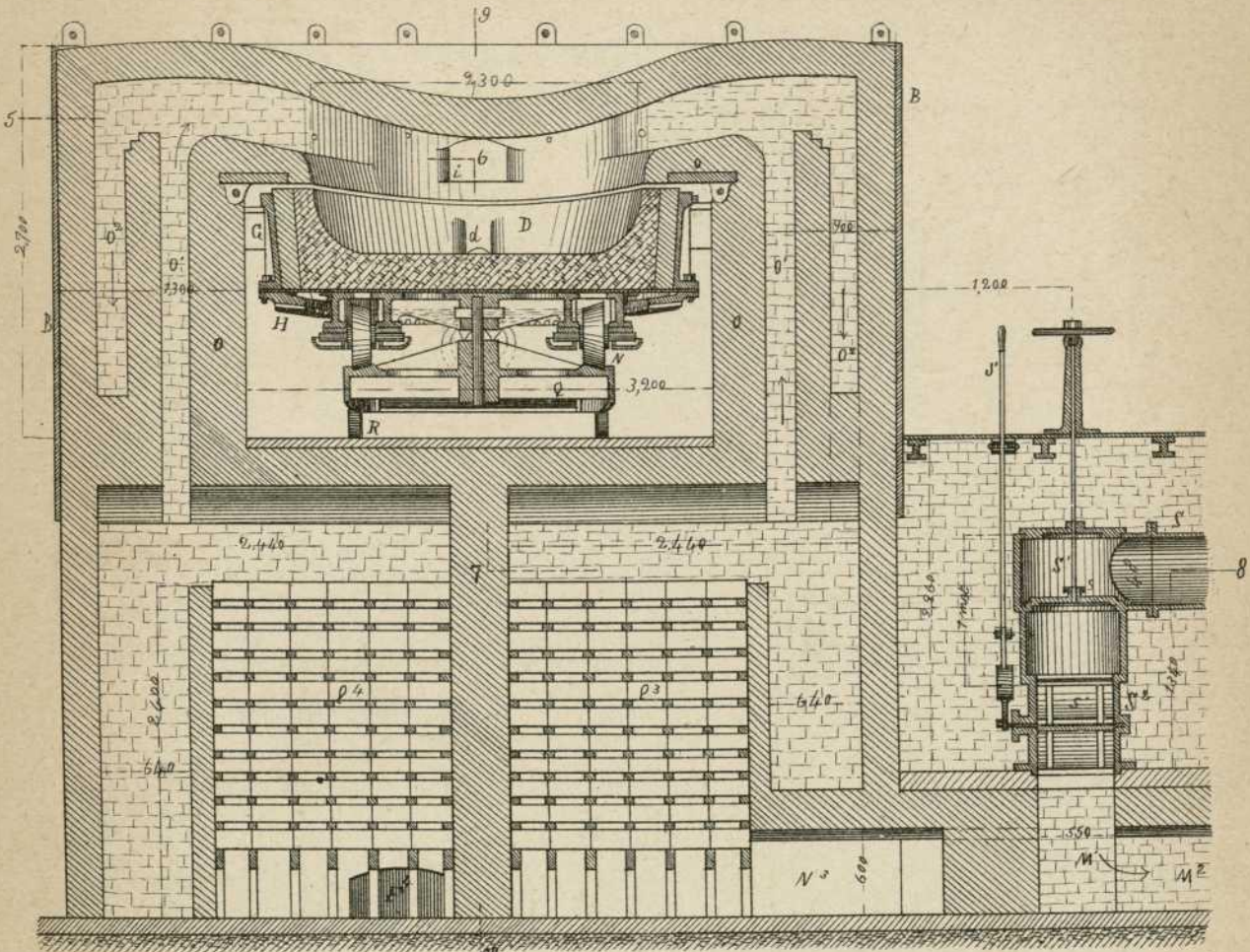


Fig. 3.

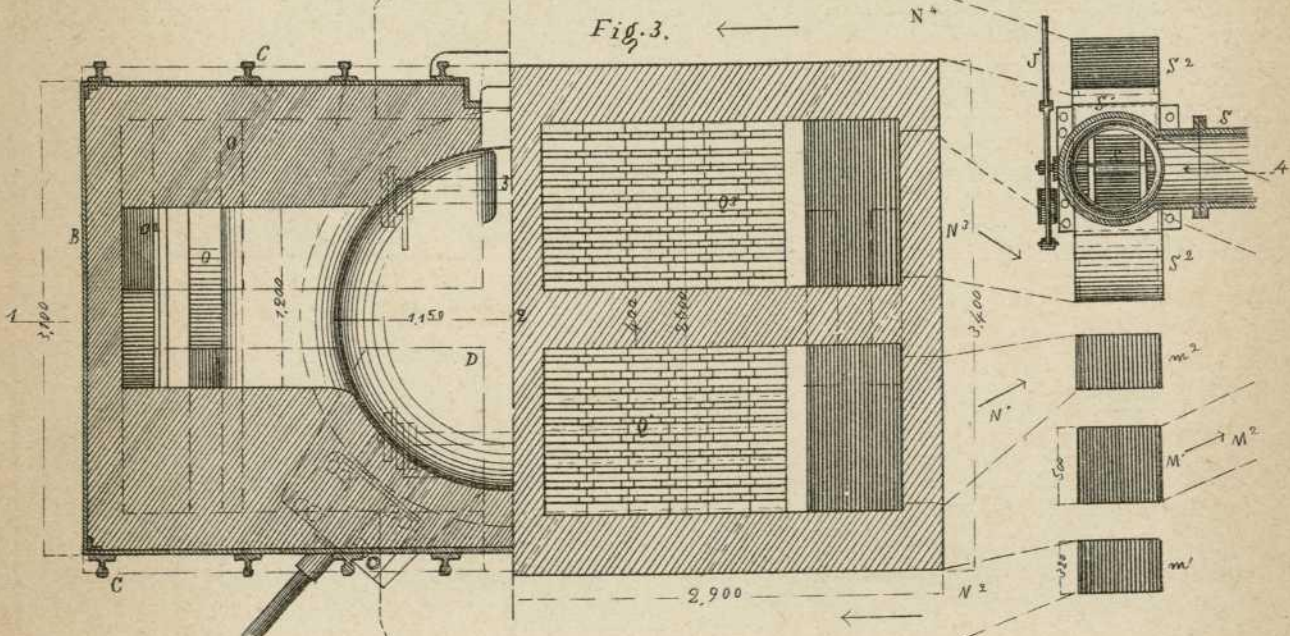


Fig. 1

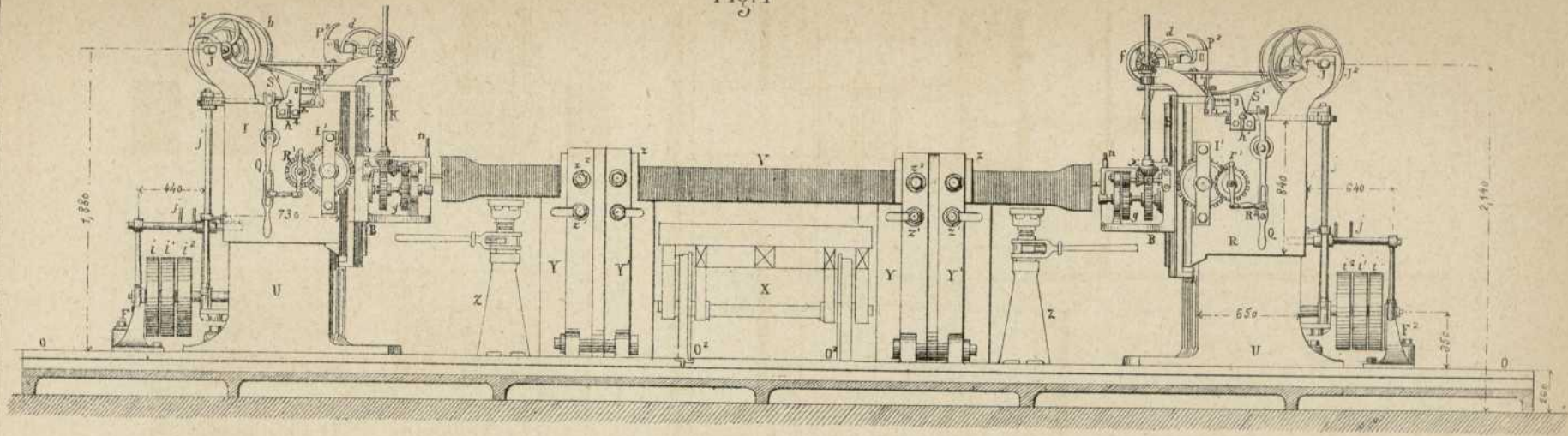


Fig. 7.

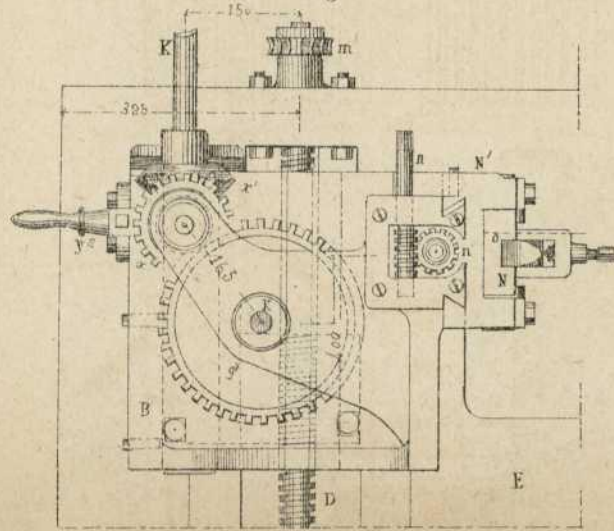


Fig. 6.

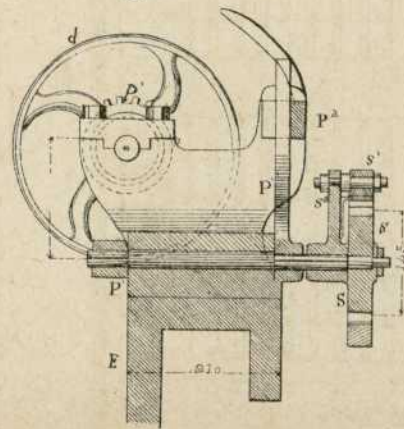


Fig. 8.

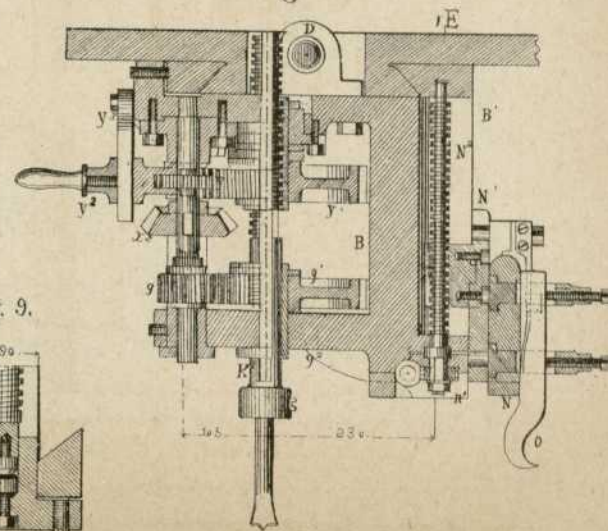
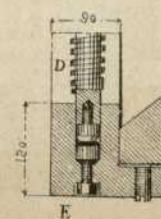


Fig. 9.



Escala de 1/40

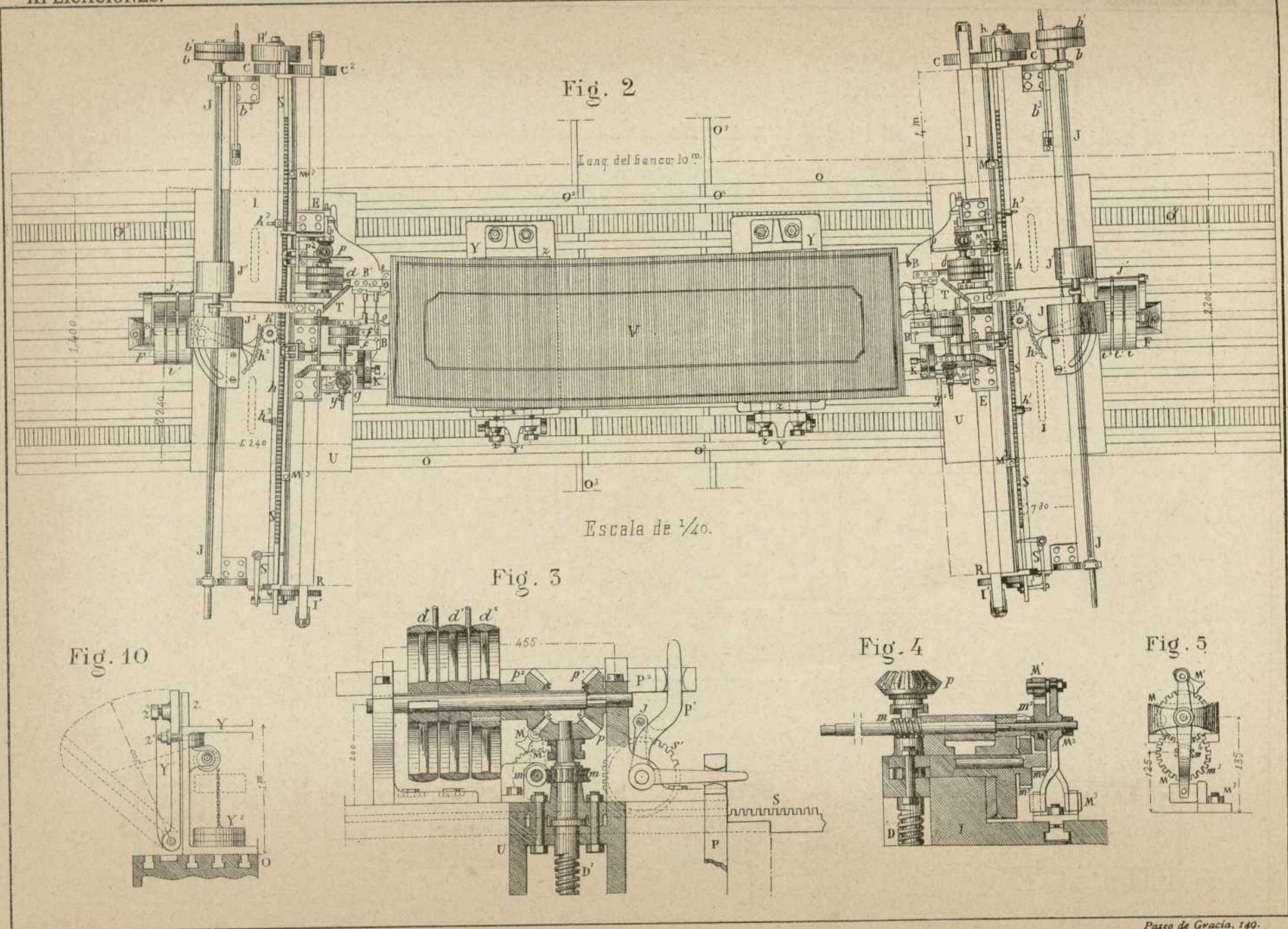


Fig. 11

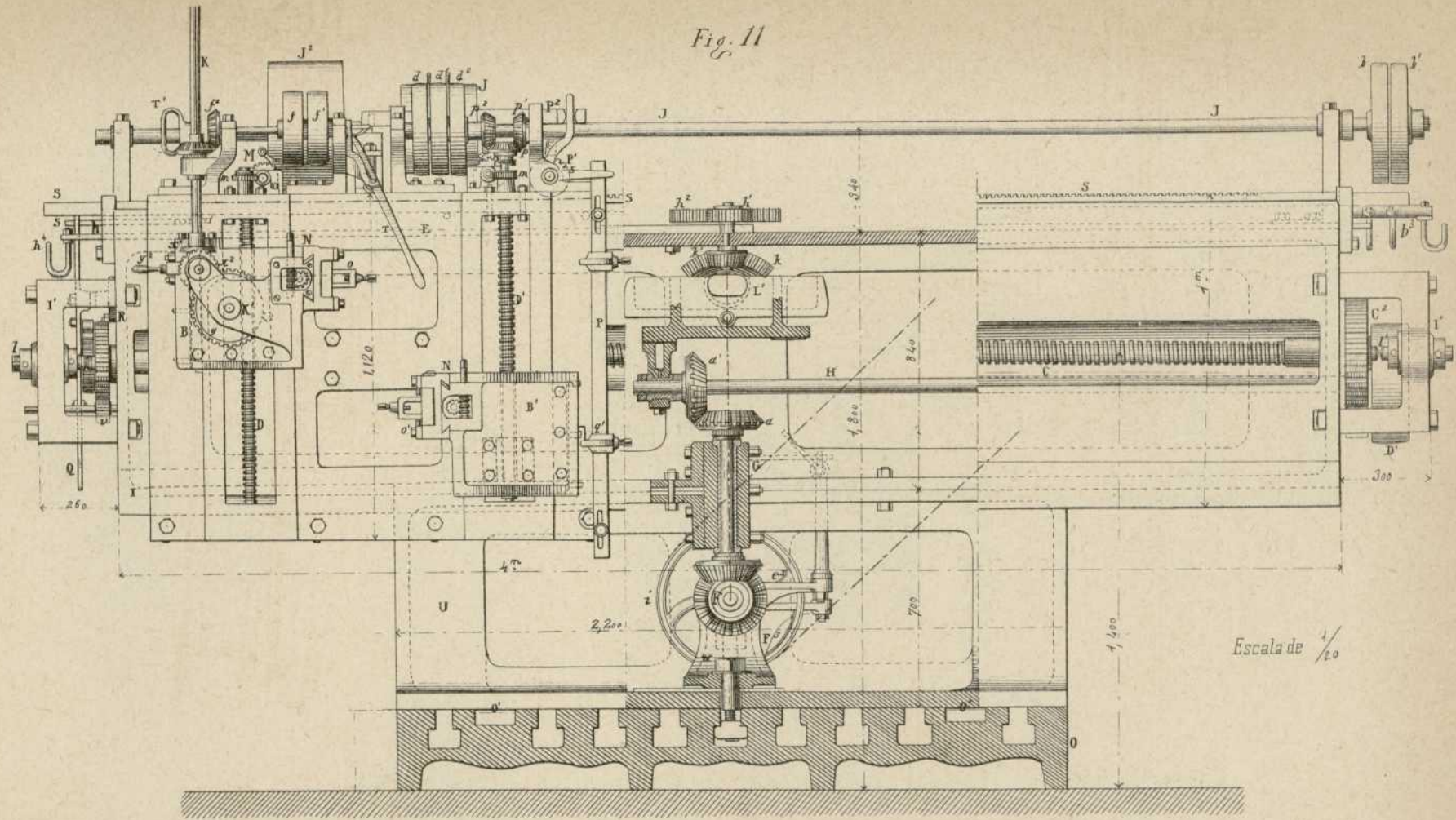


Fig. 17

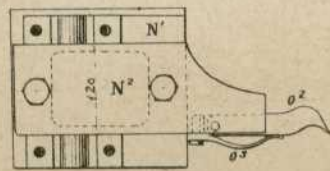


Fig. 18

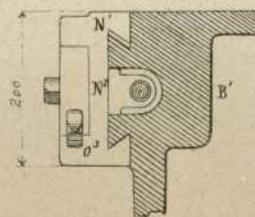


Fig. 19

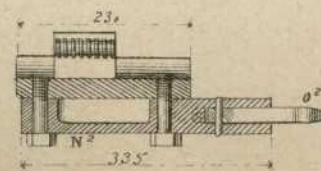
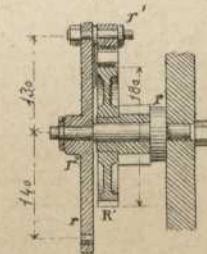
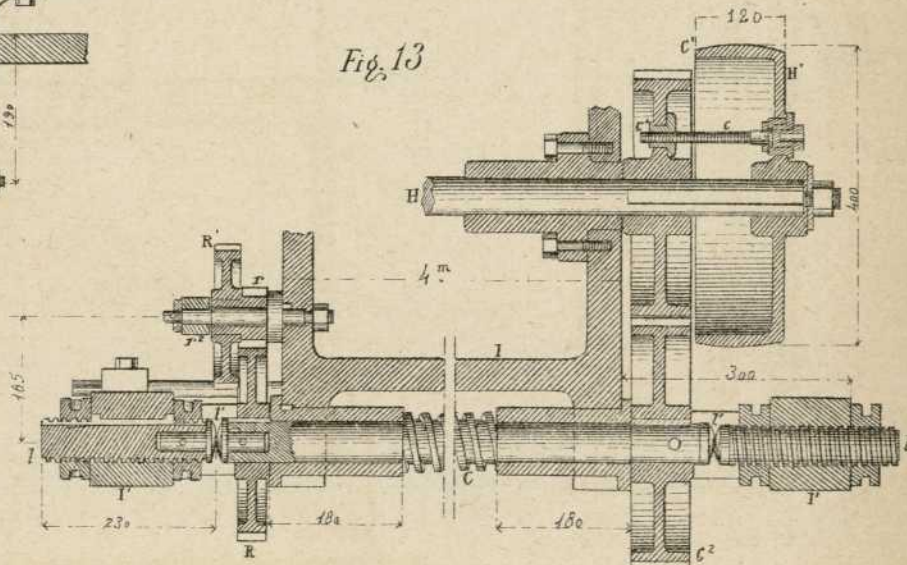
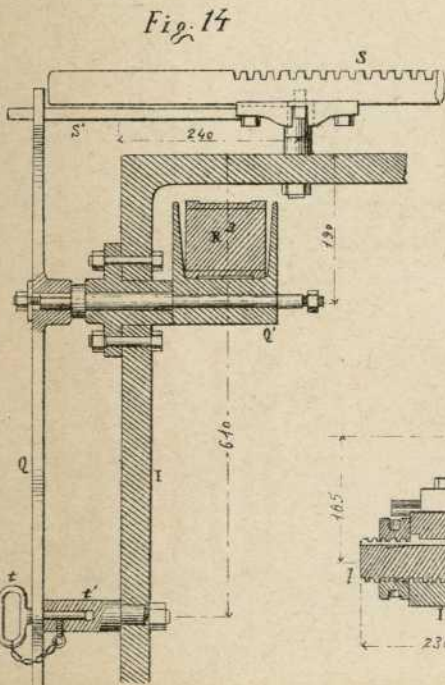
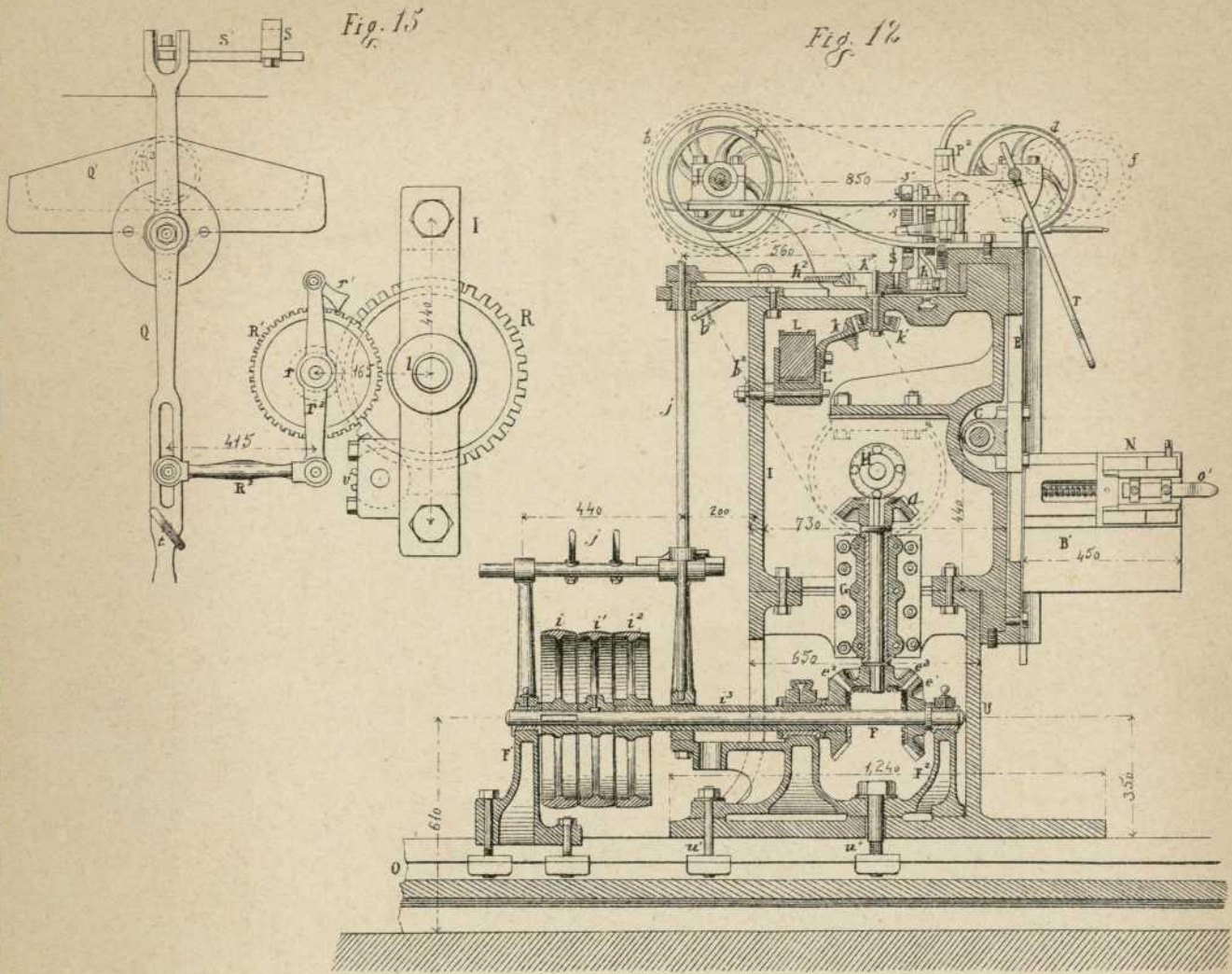


Fig. 16





Escala de 1/10

Fig. 1.

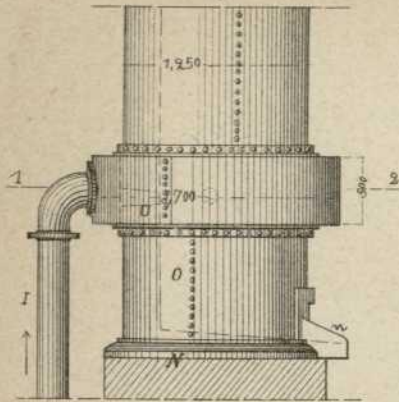


Fig. 3.

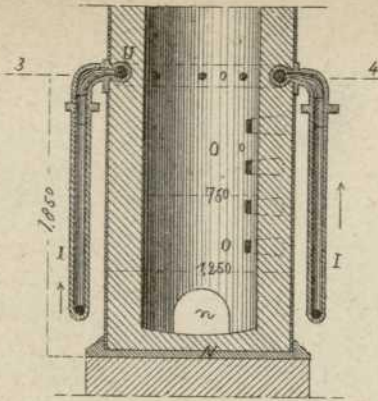


Fig. 19.

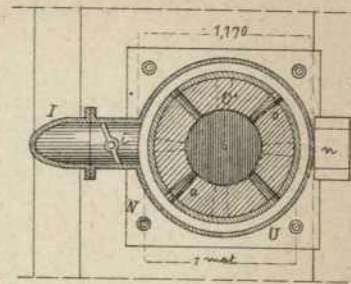


Fig. 2.

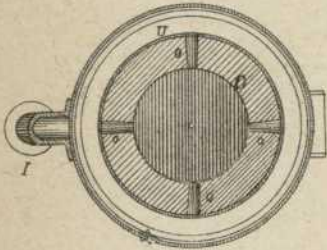


Fig. 4.

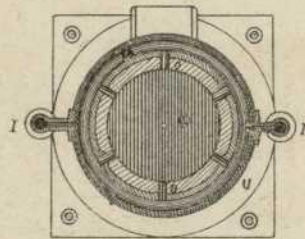


Fig. 14.



1/10

Fig. 11.

Fig. 13.

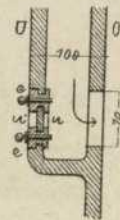


Fig. 5.

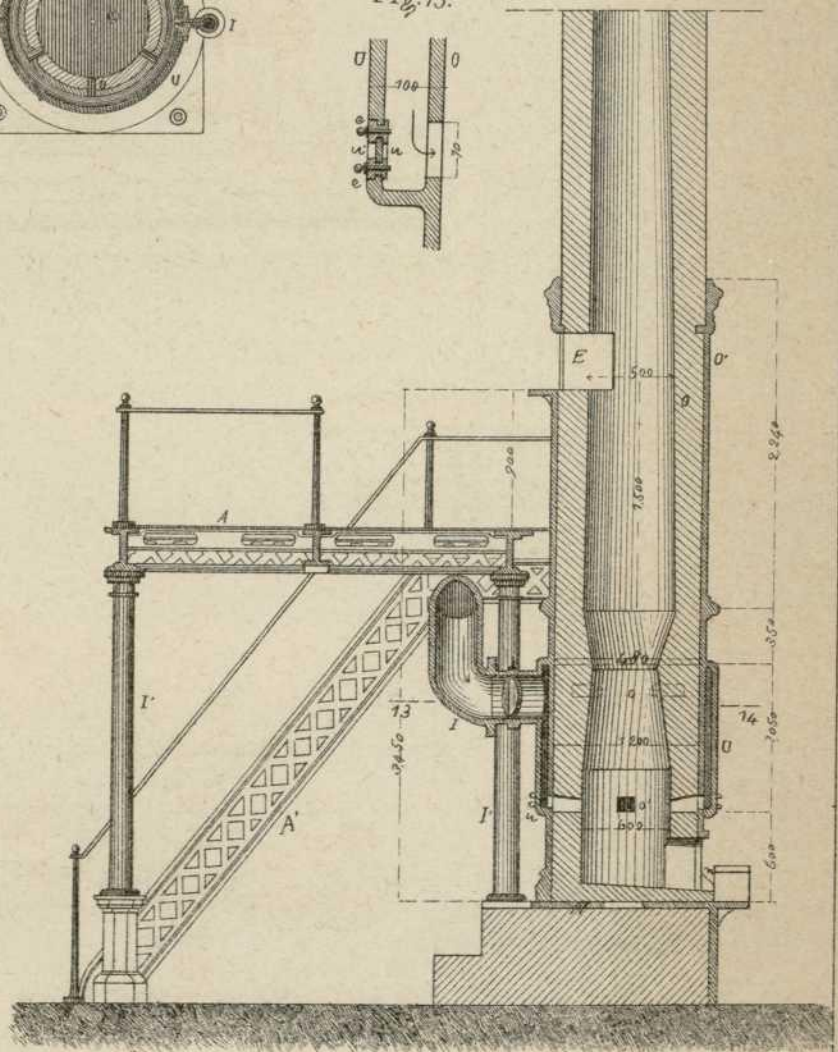
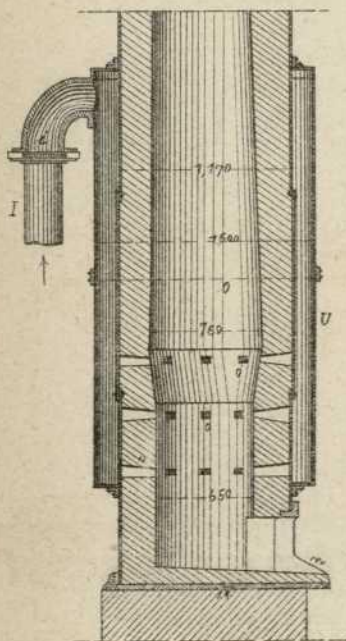


Fig. 6.

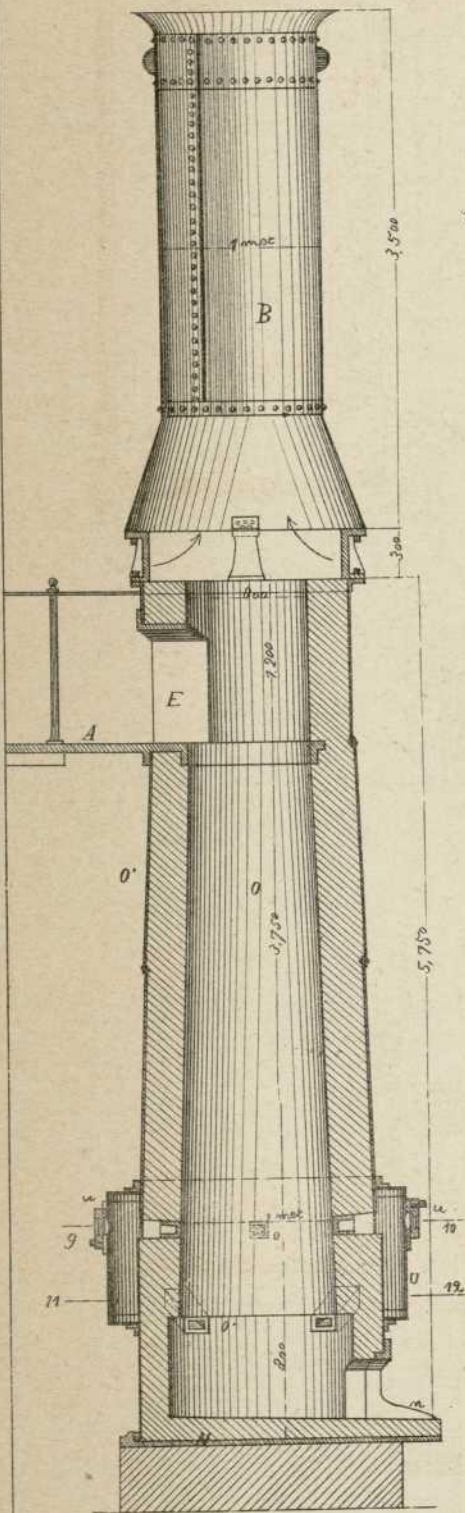


Fig. 8.

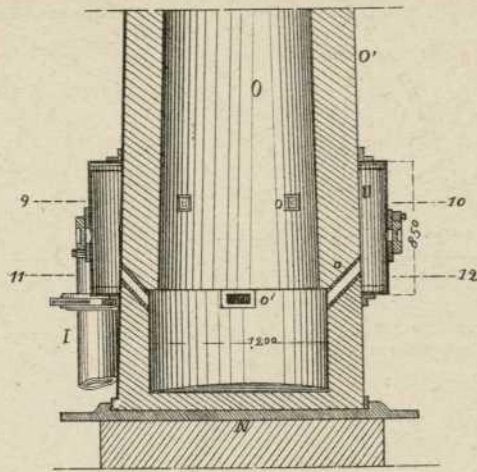


Fig. 7.

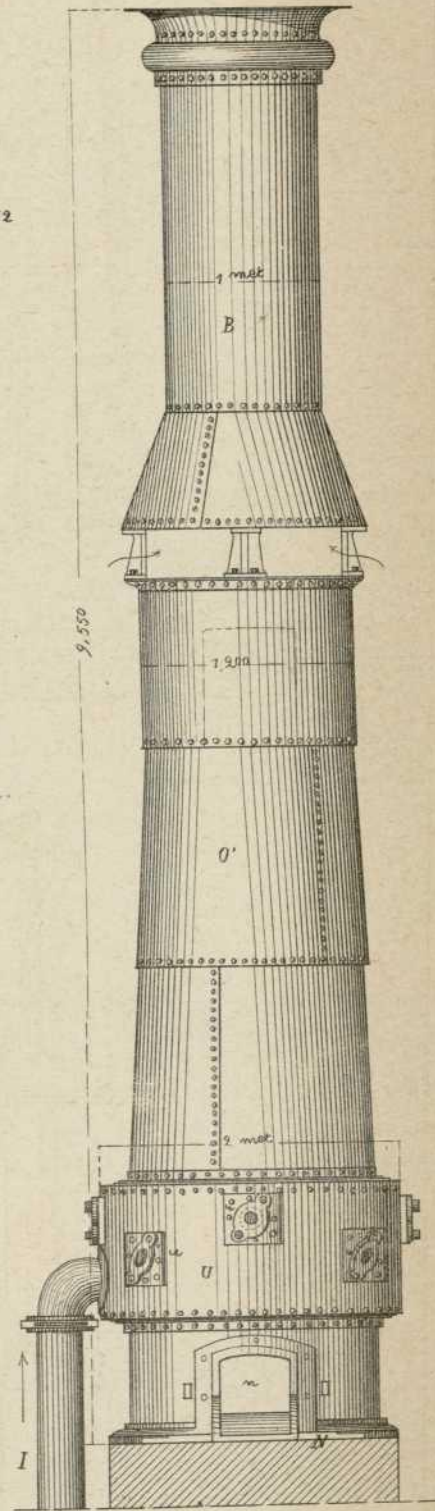


Fig. 9.

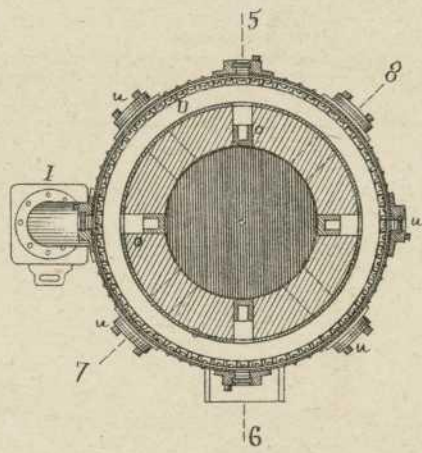
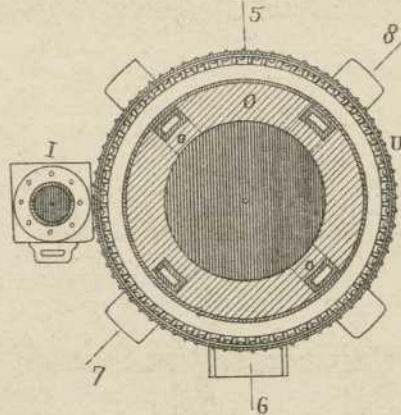
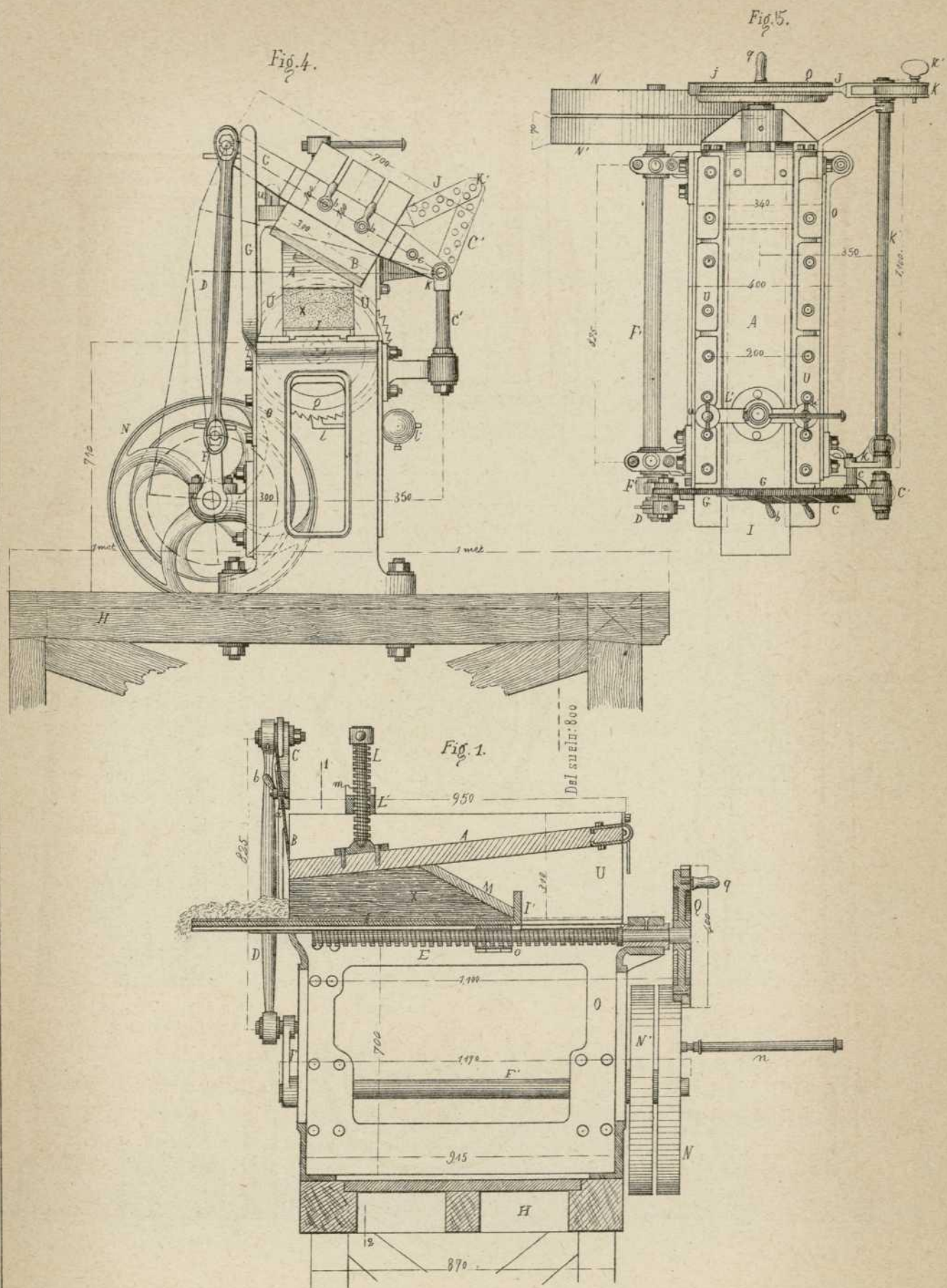
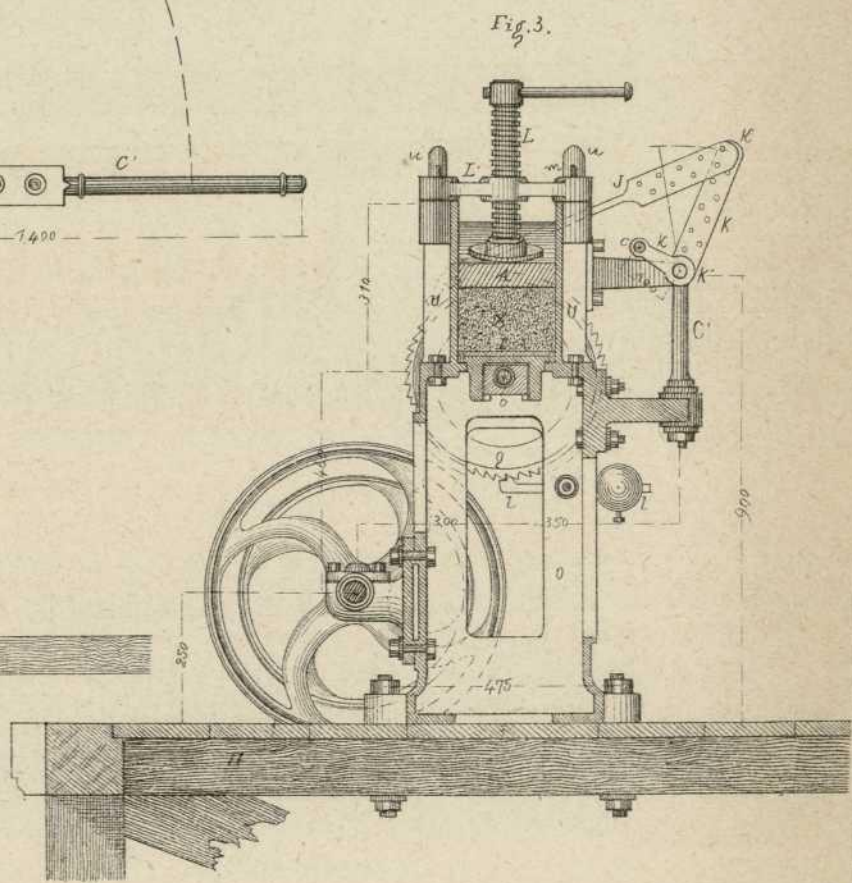
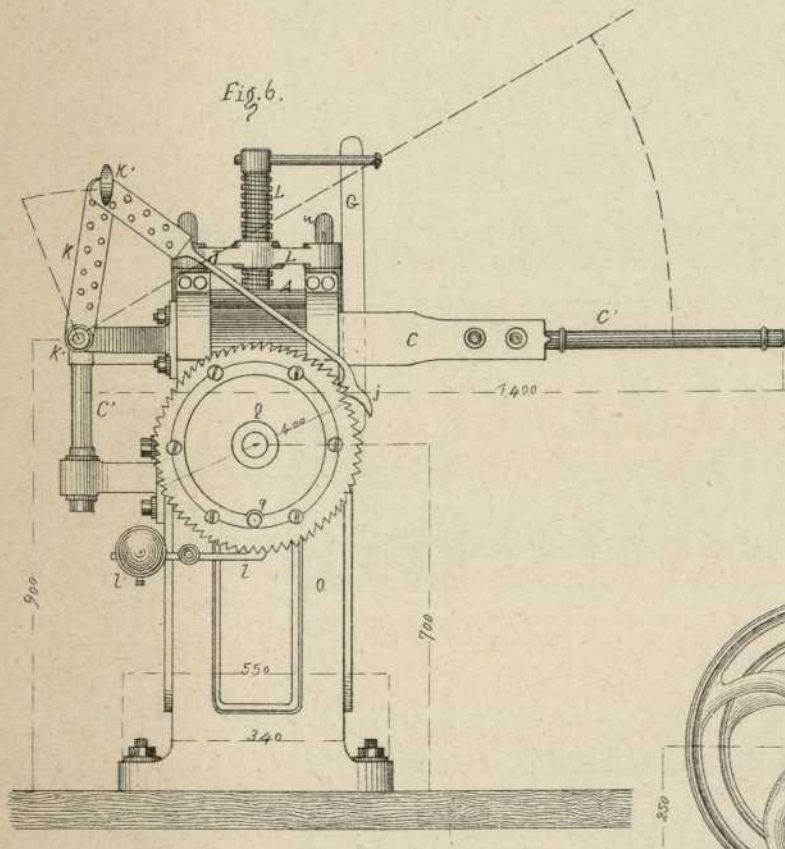
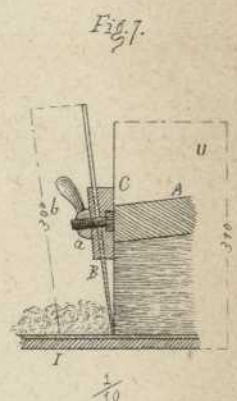
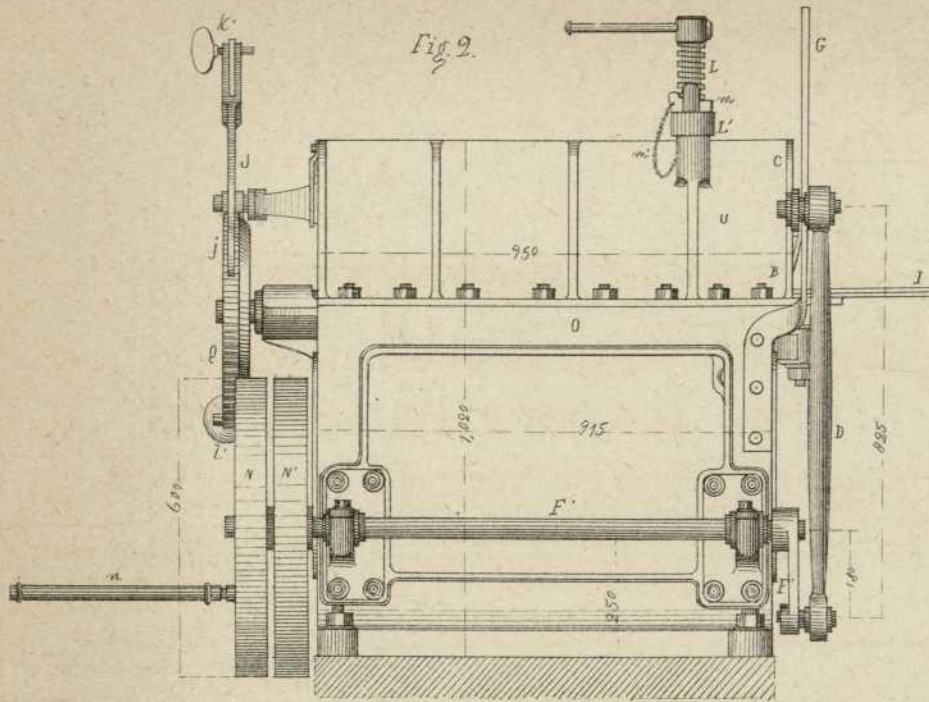


Fig. 10.

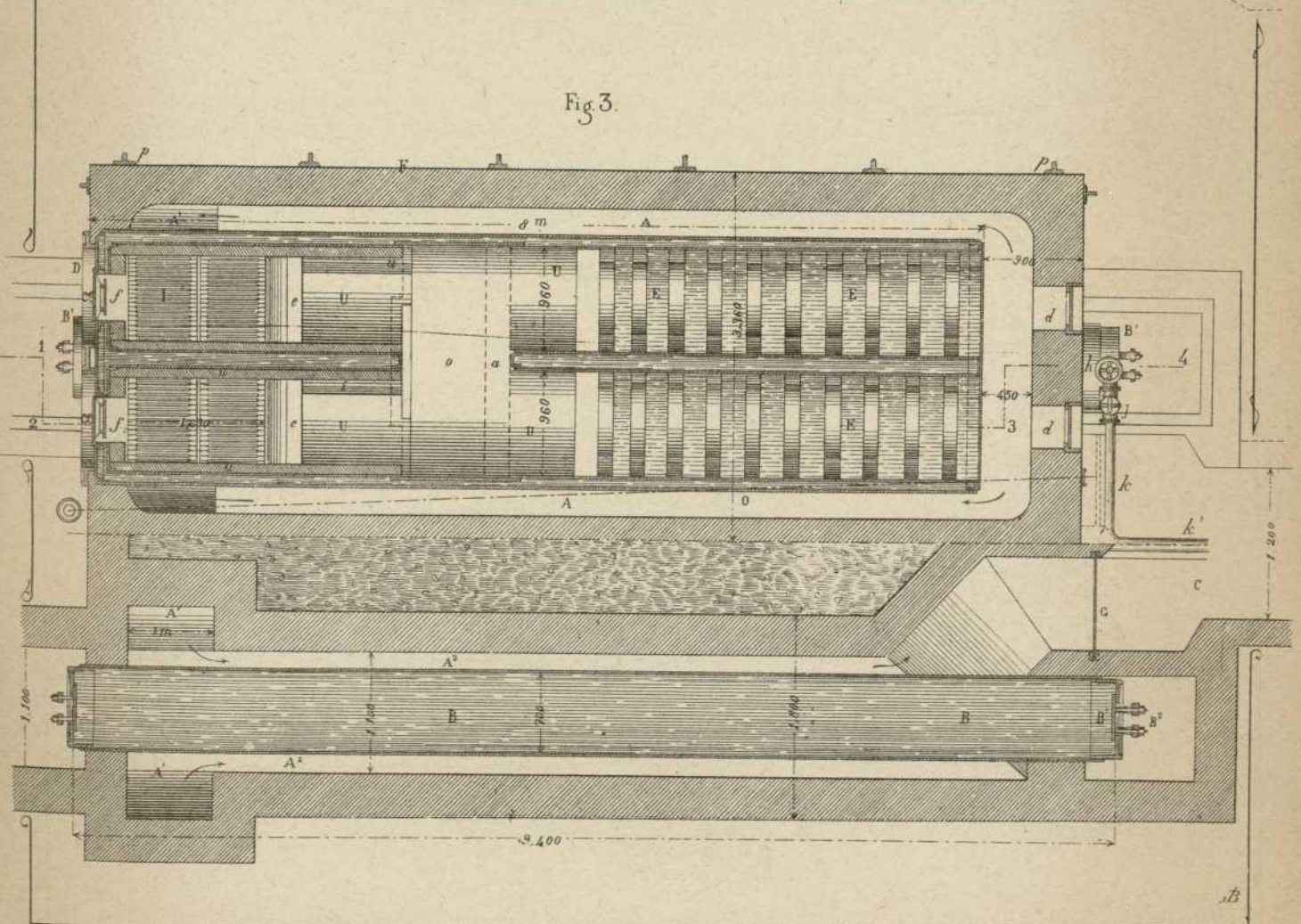
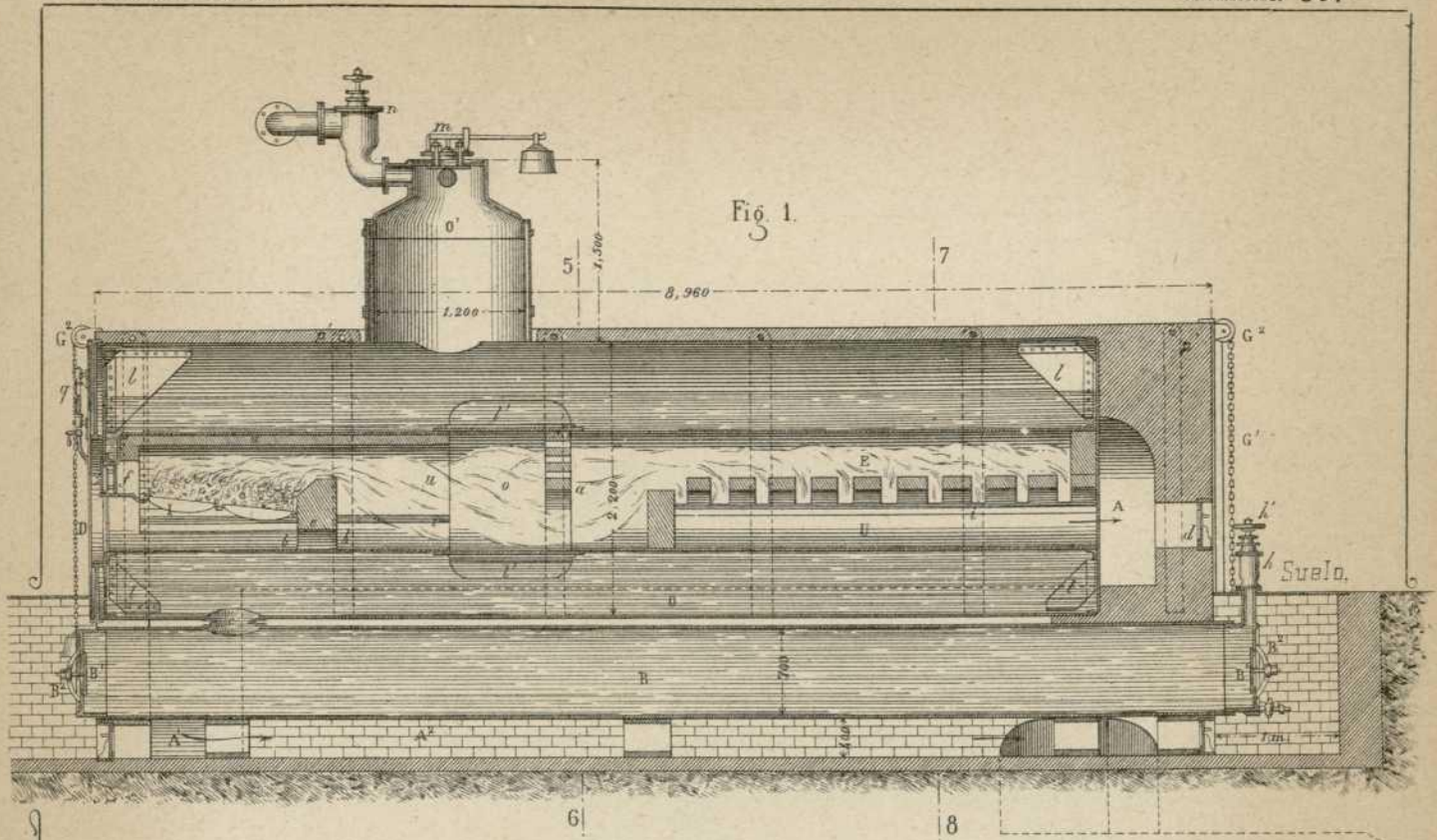


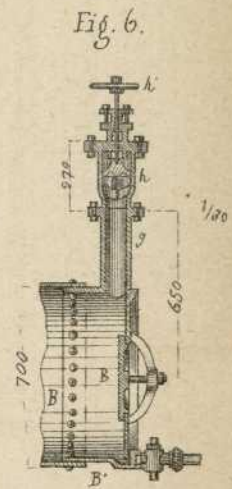
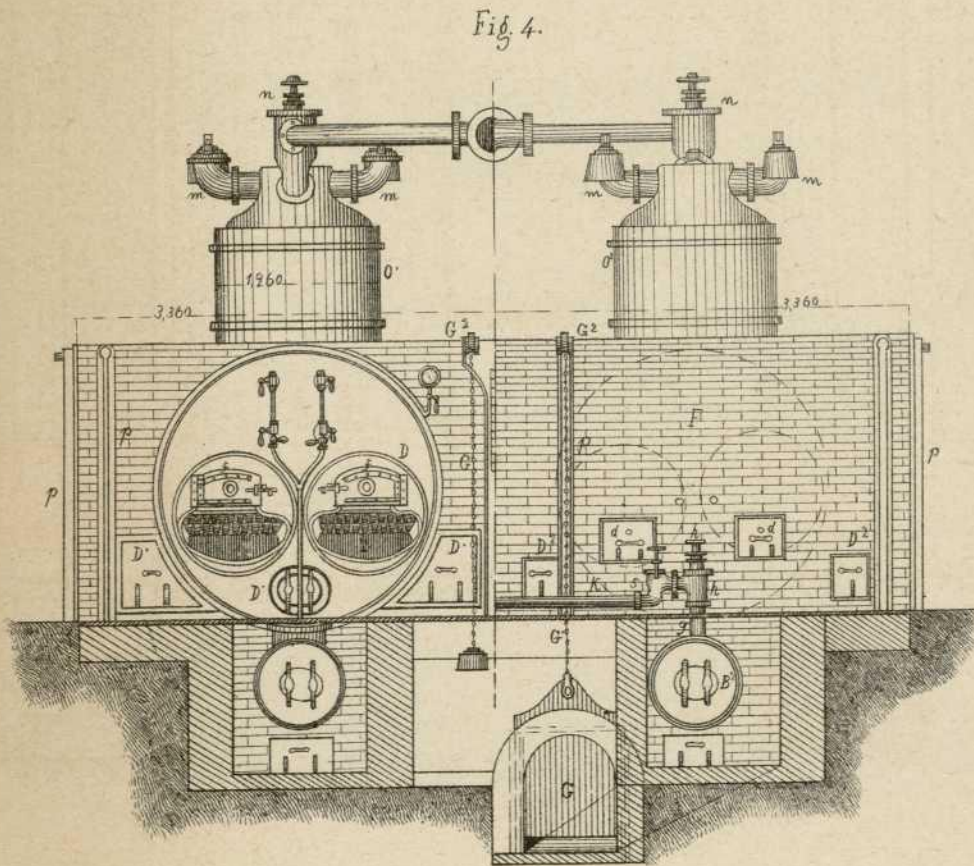
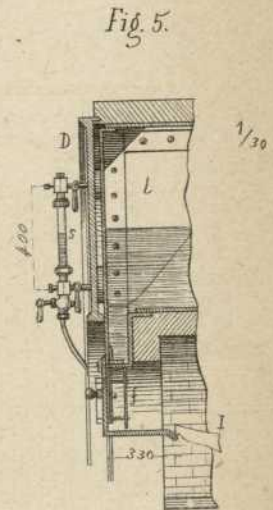
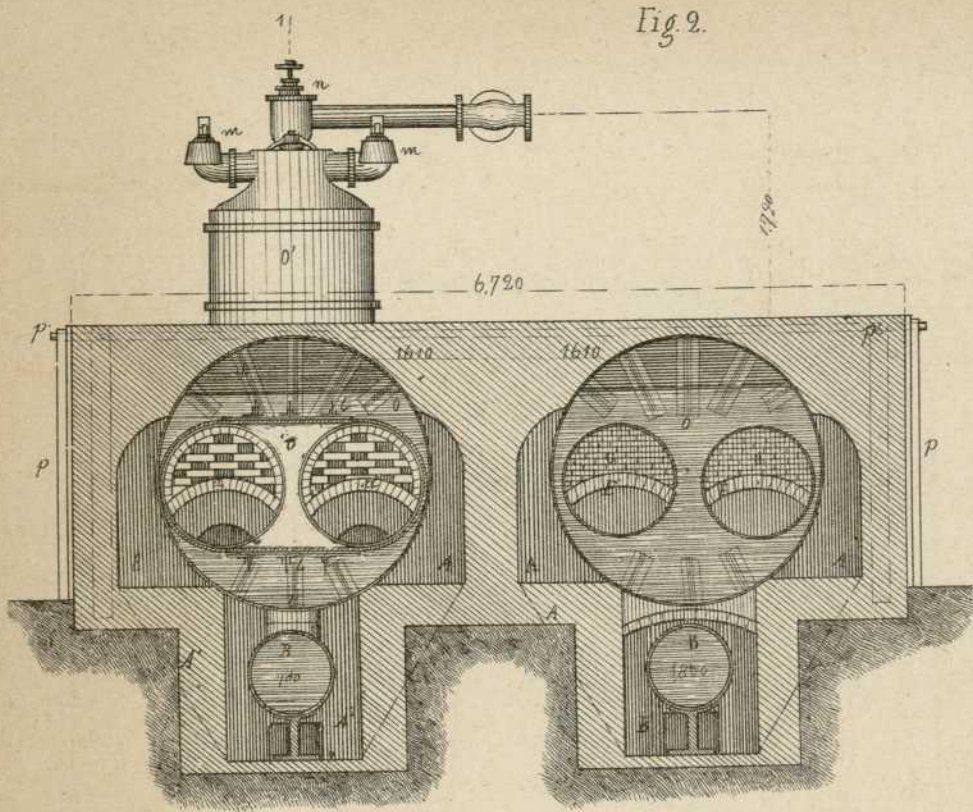
Escala de 1/50





Escala de 1/15





Escala de 1/60

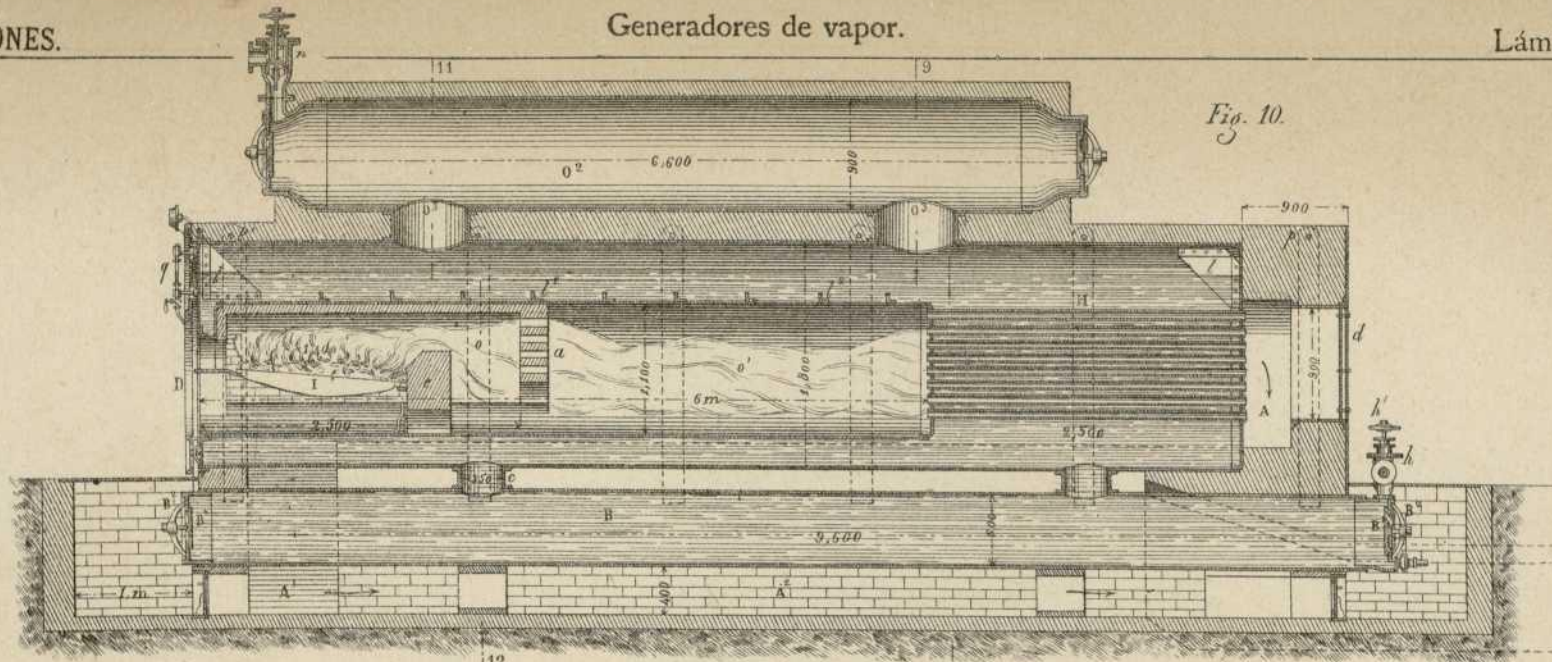


Fig. 10.

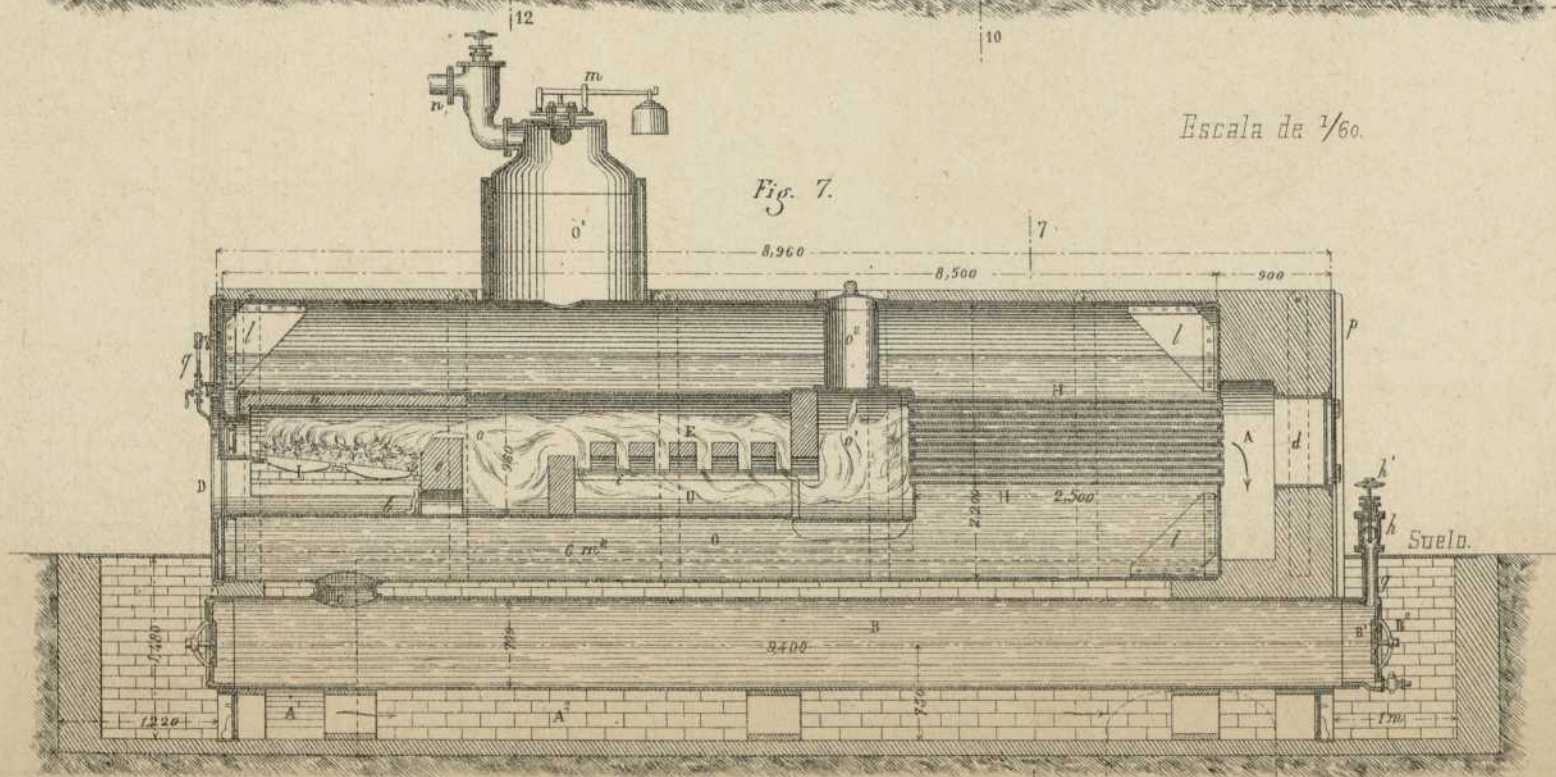


Fig. 7.

Escala de 1/60.

Fig. 8.

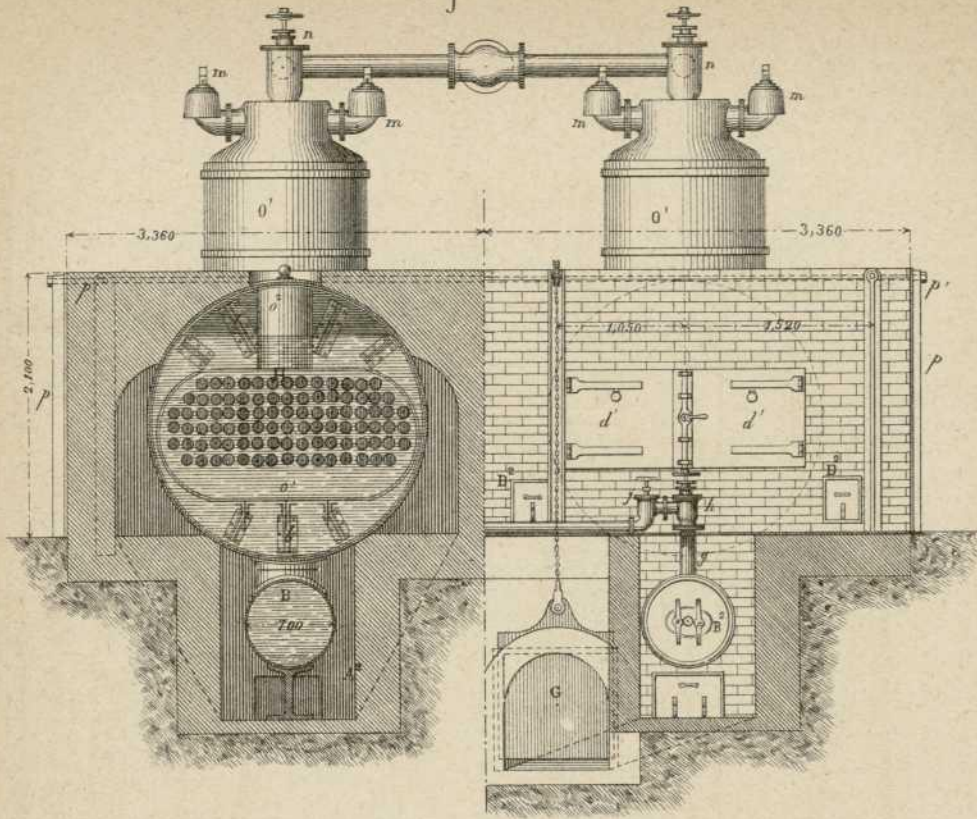


Fig. 9.

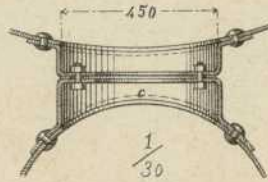


Fig. 12.

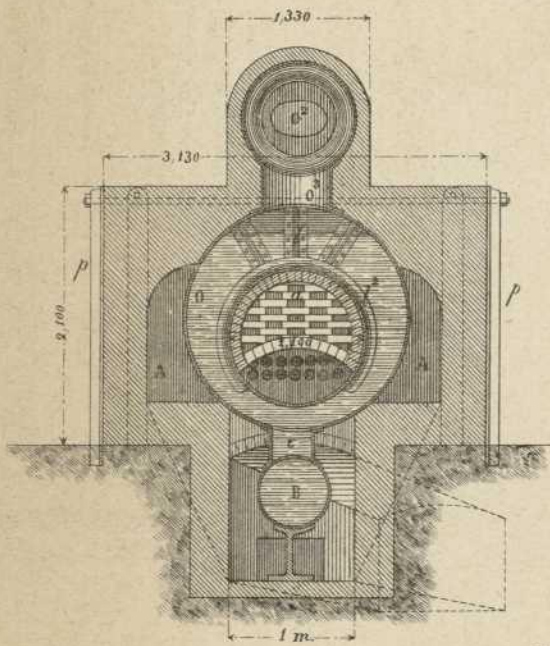
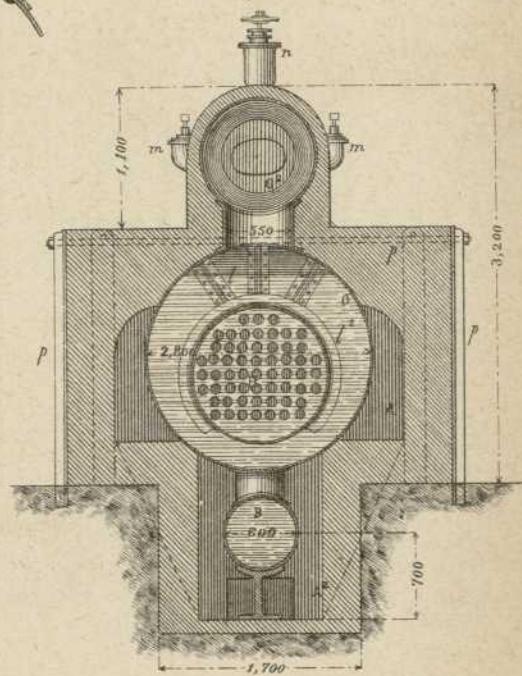


Fig. 11.



Escala de 1/60

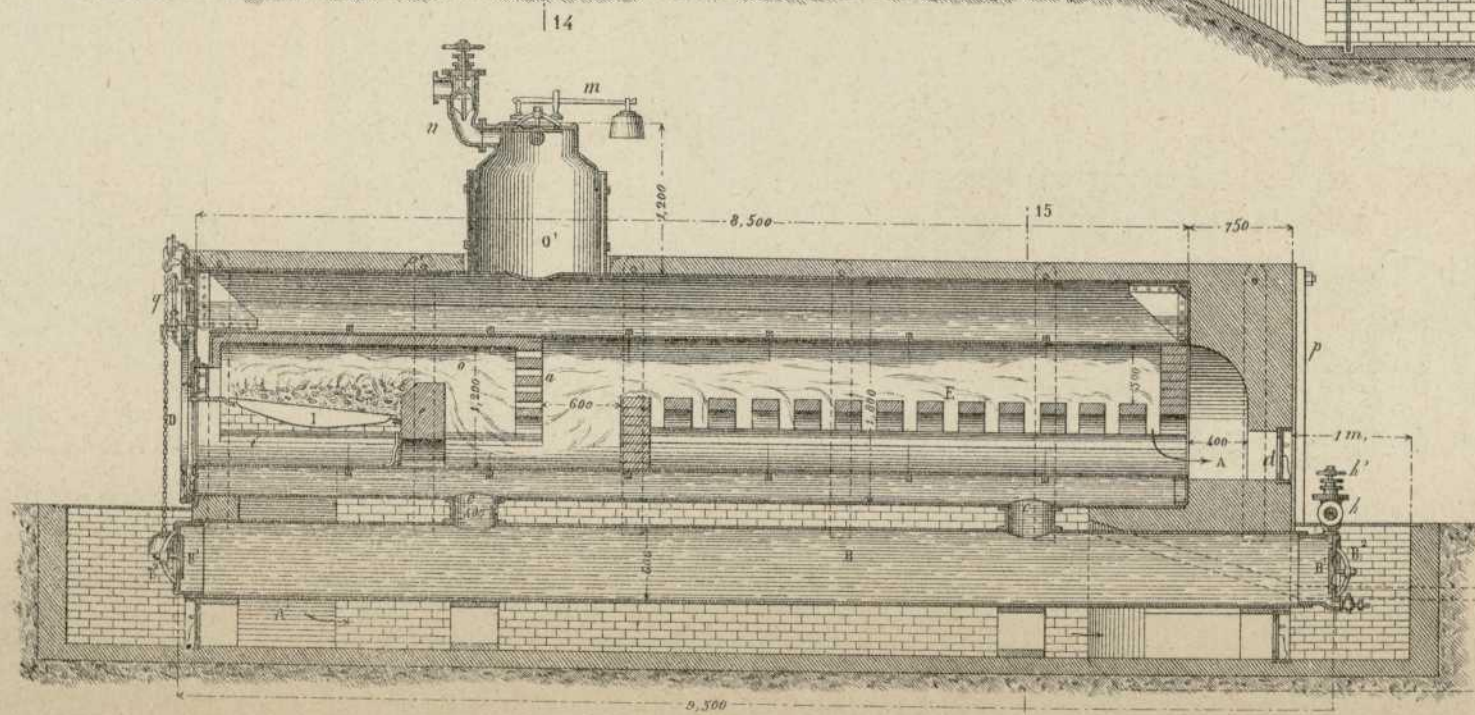
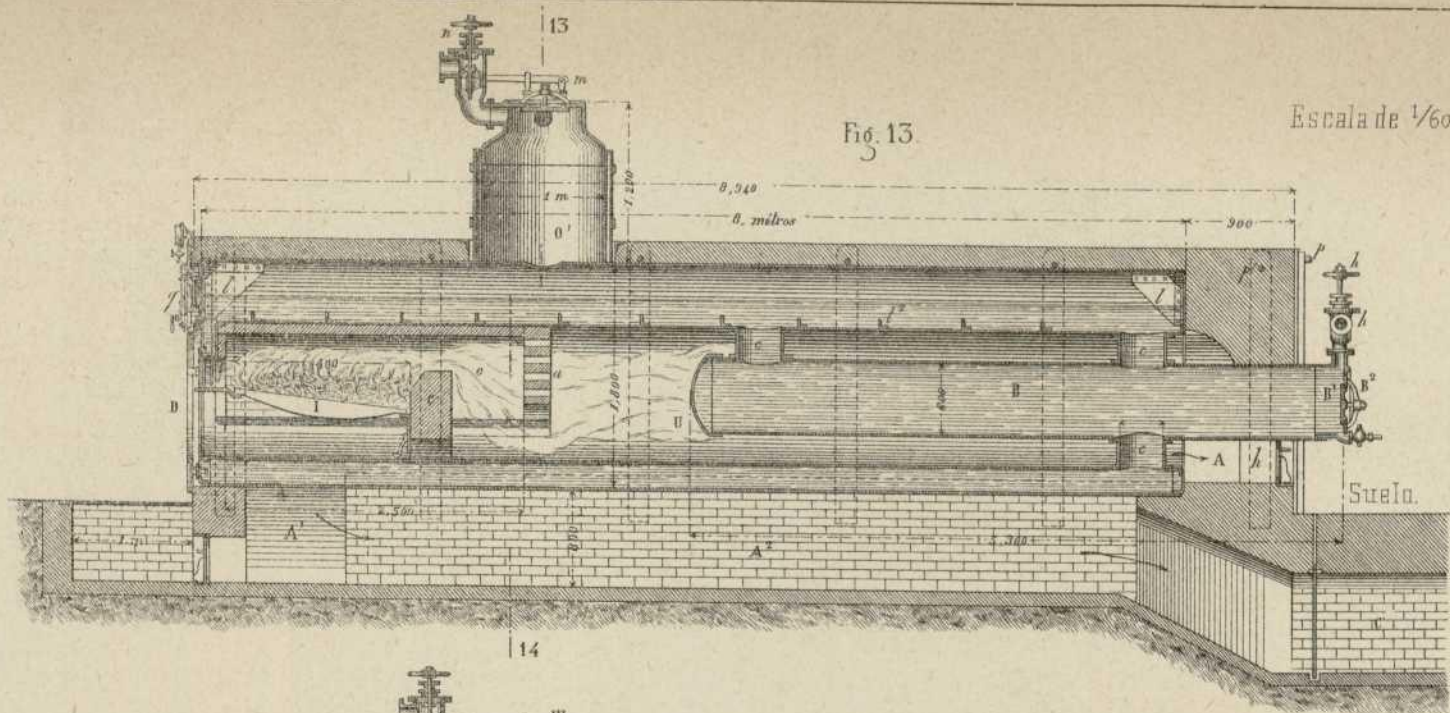


Fig. 14.

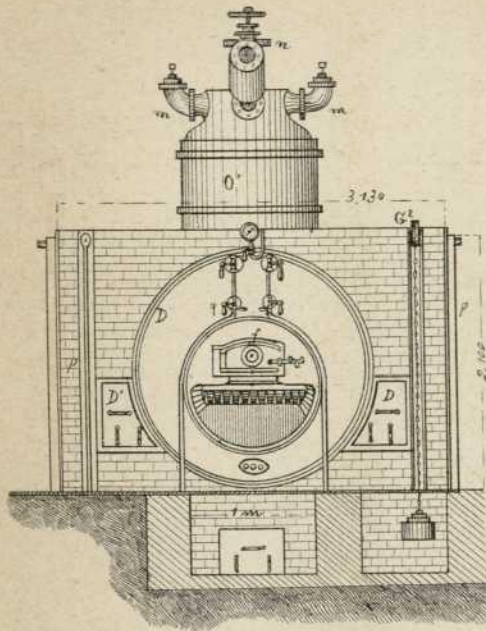


Fig. 15.

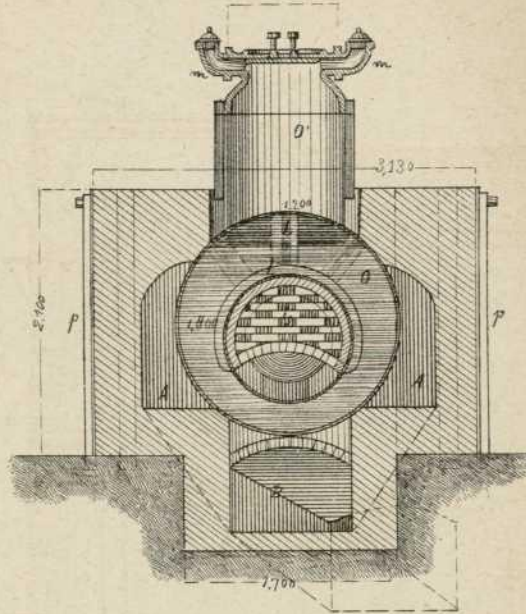


Fig. 16.

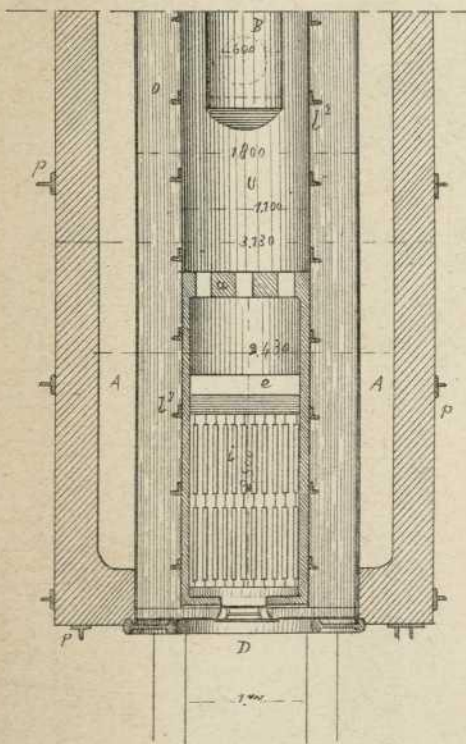
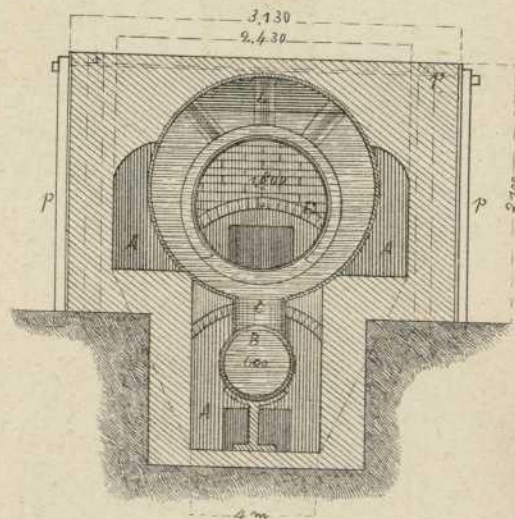


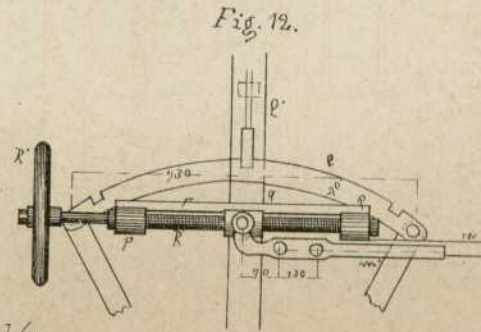
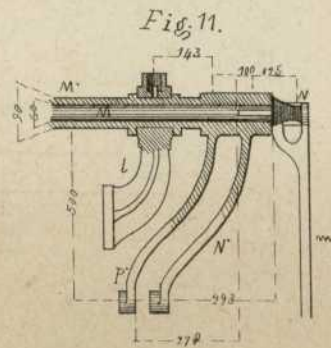
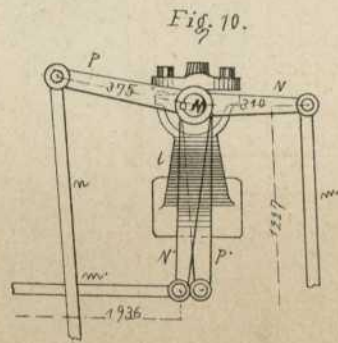
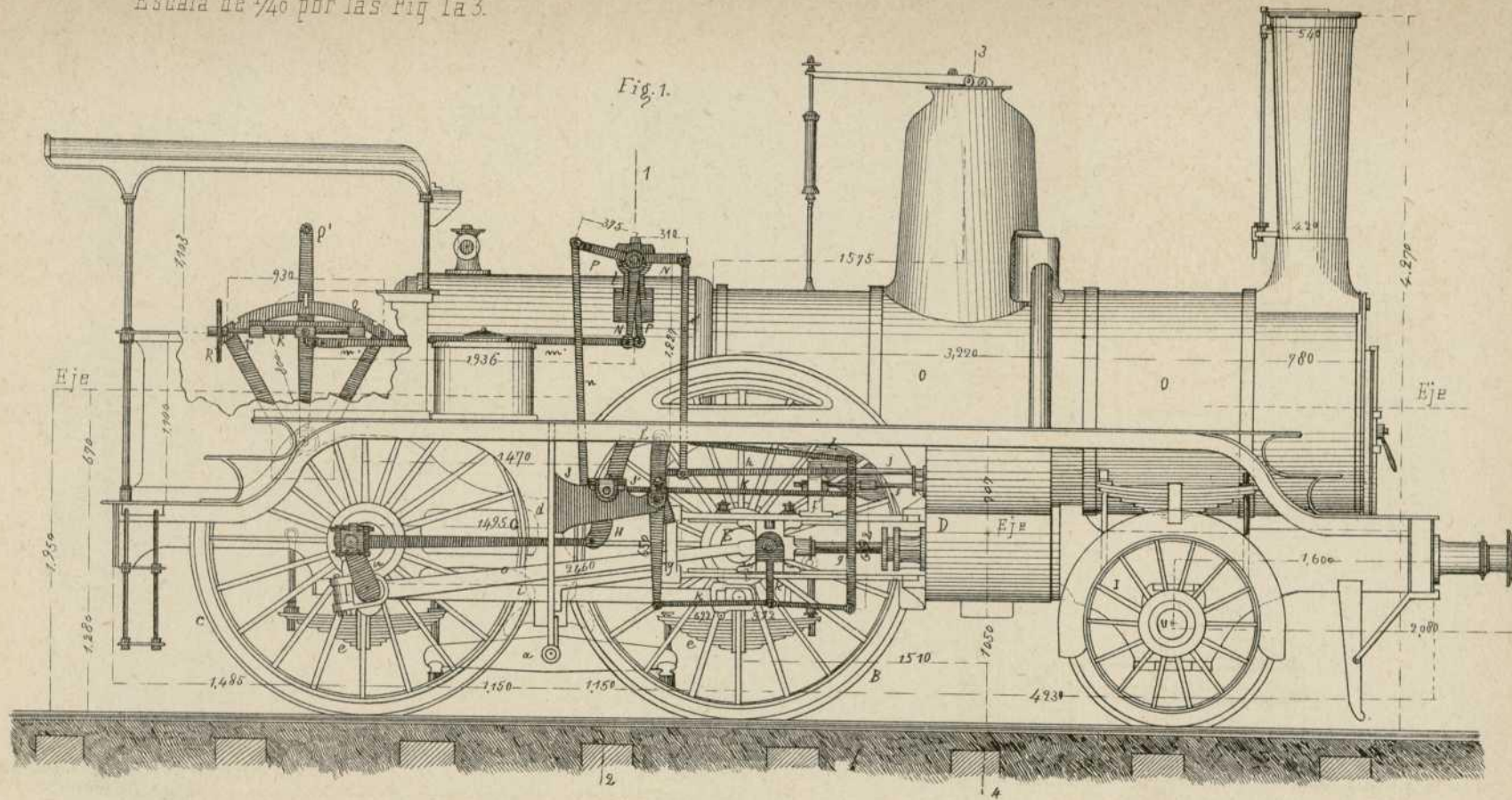
Fig. 18.

Corte por 15-16.



Escala de 1/60

Escala de 1/40 por las Fig 1a 3.



Escala de 1/20

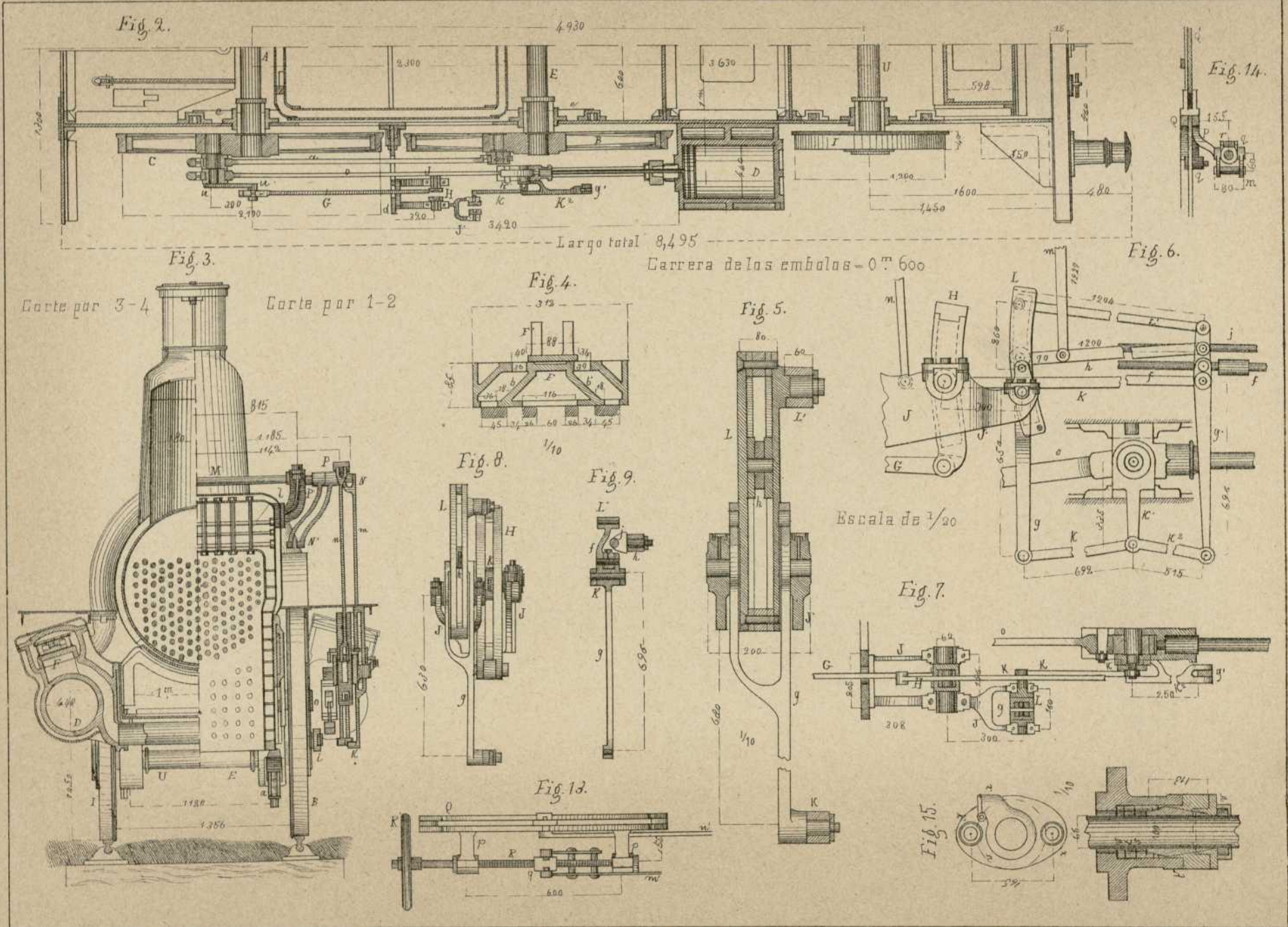
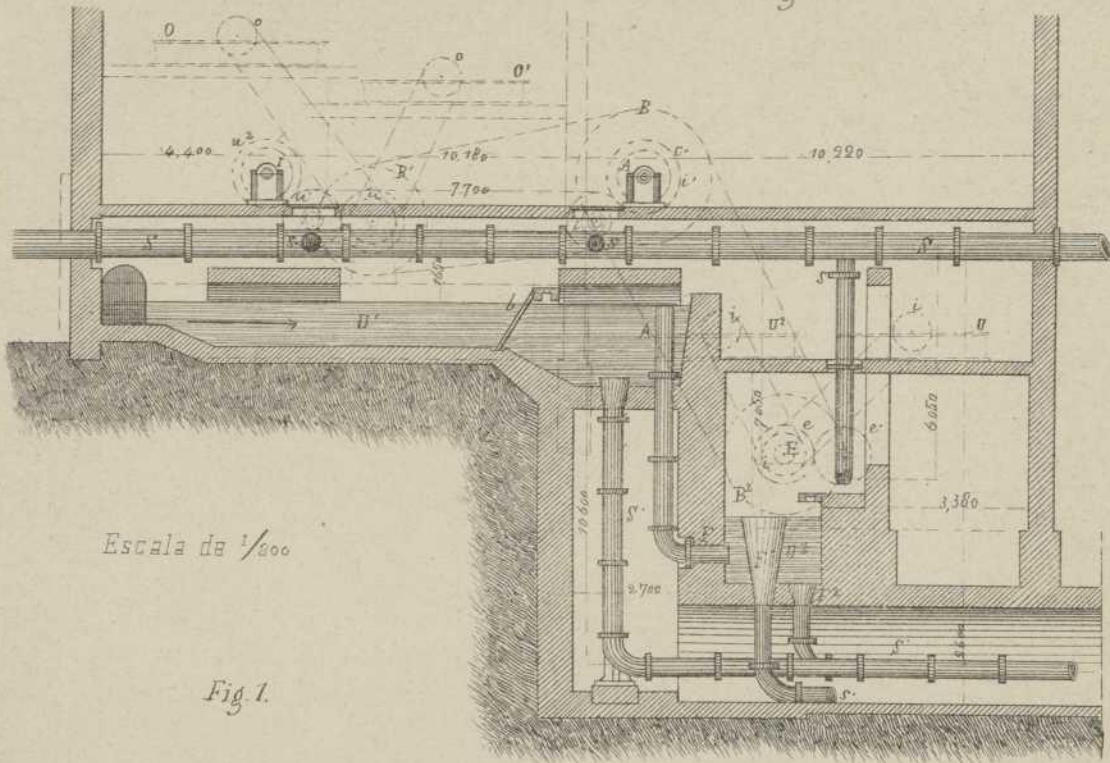


Fig. 2.



Escala de 1/200

Fig. 1.

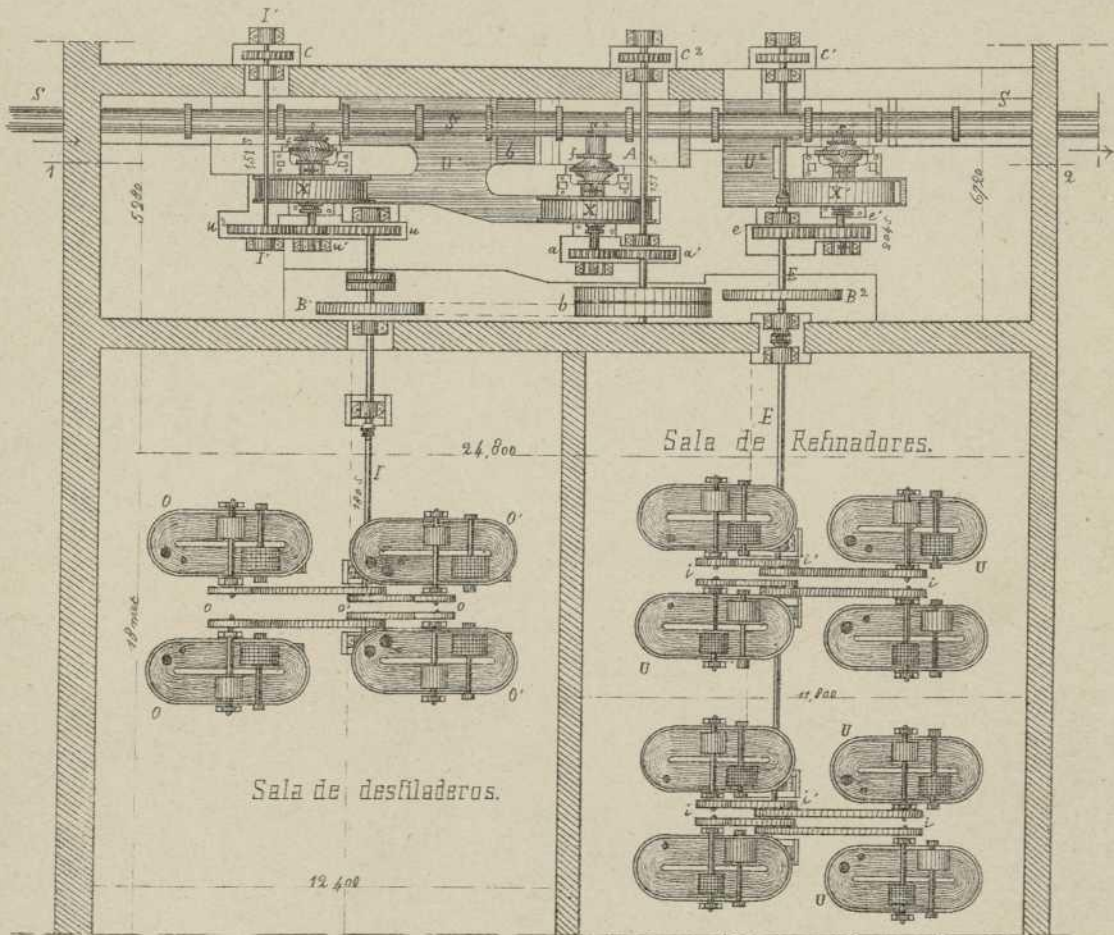
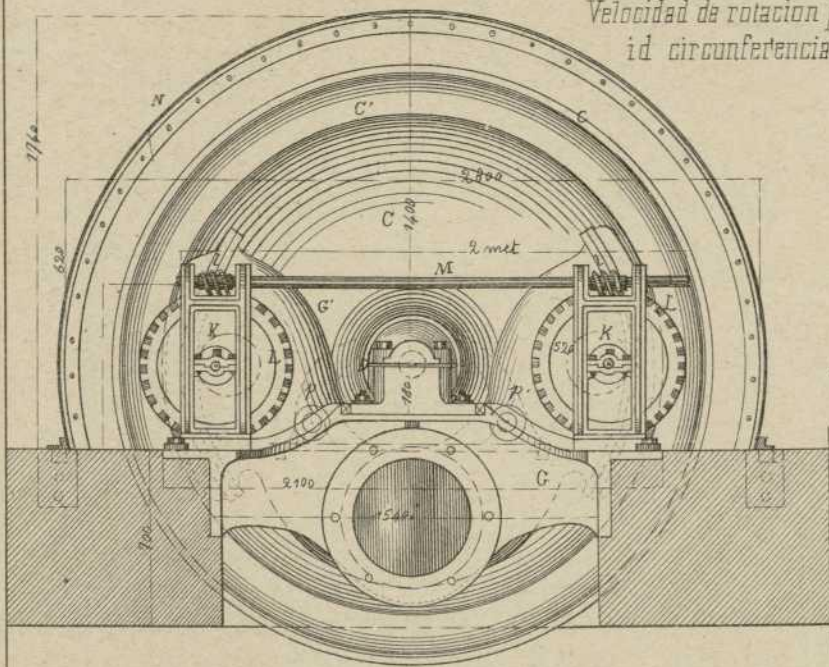


Fig. 3.



Altura del salto 140^m
 Velocidad de rotación por l' 204 vueltas
 id. circunferencial por l' 25^m 63

Fig. 5.

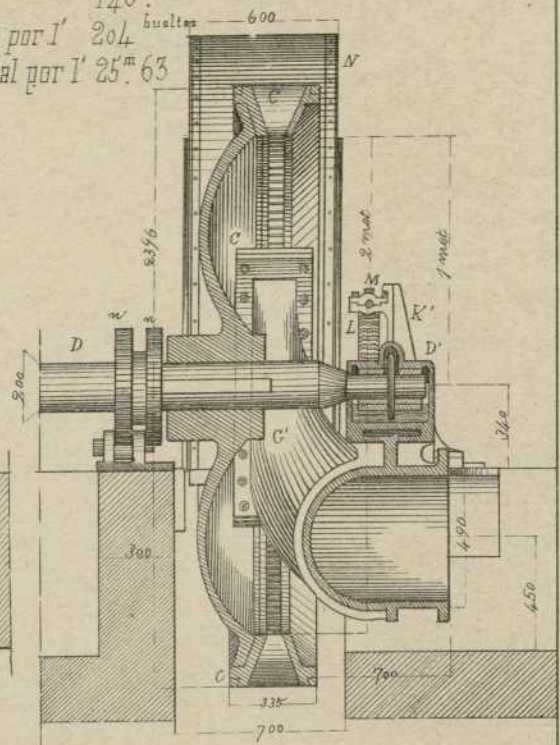
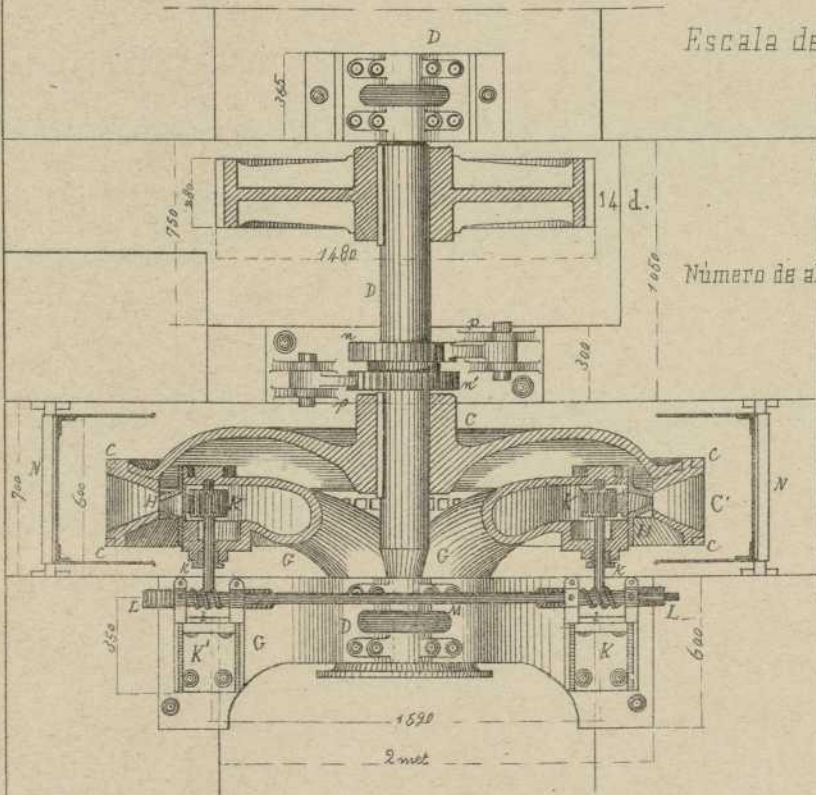


Fig. 4.



Escala de 1/30

Número de alabes 34.

Fig. 6.

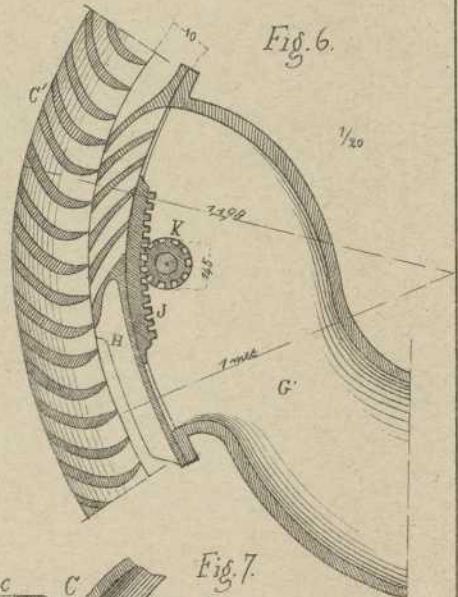
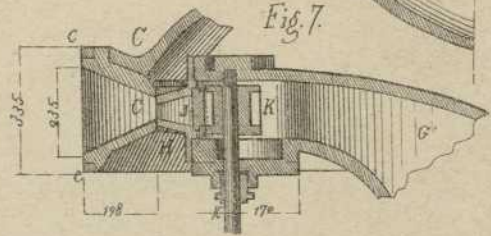
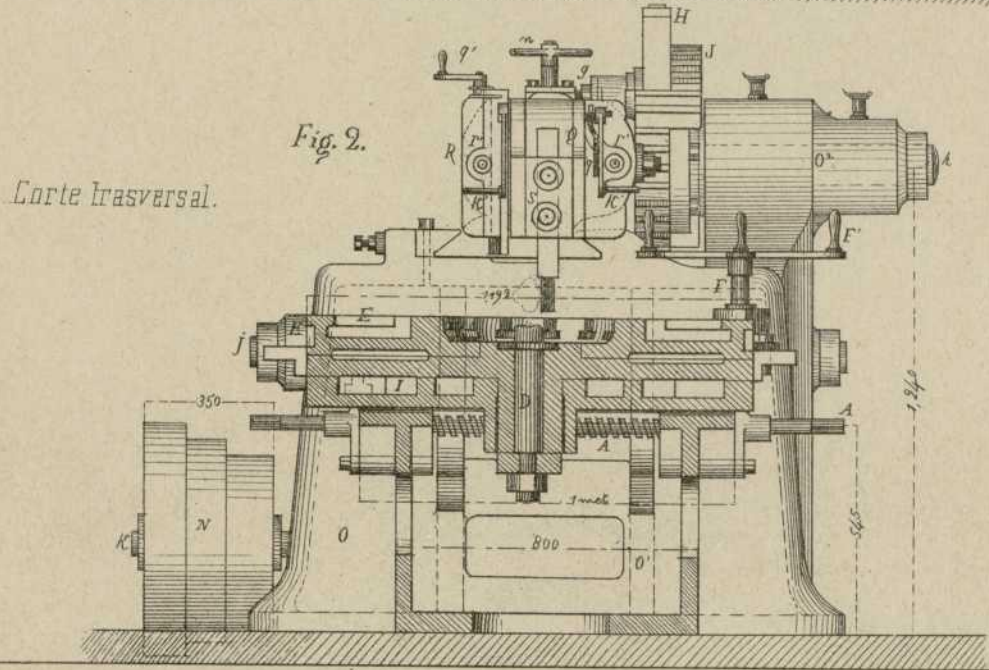
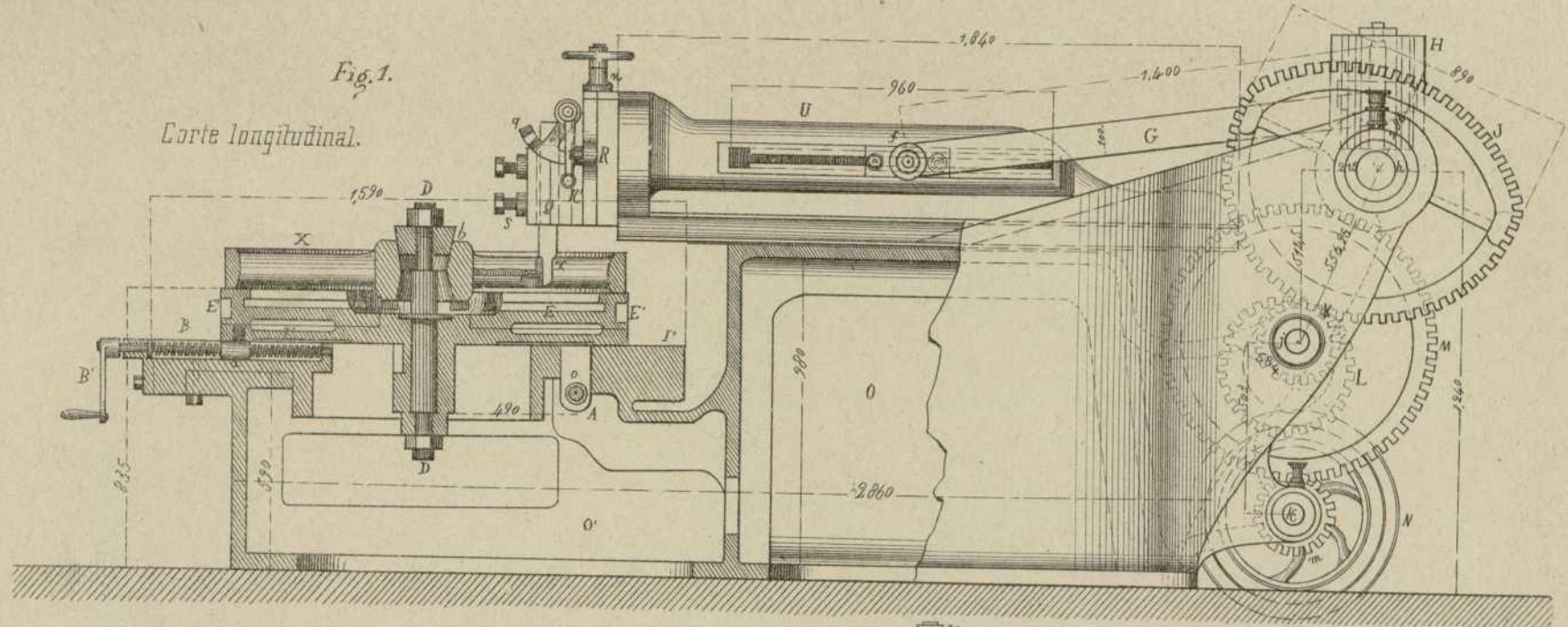
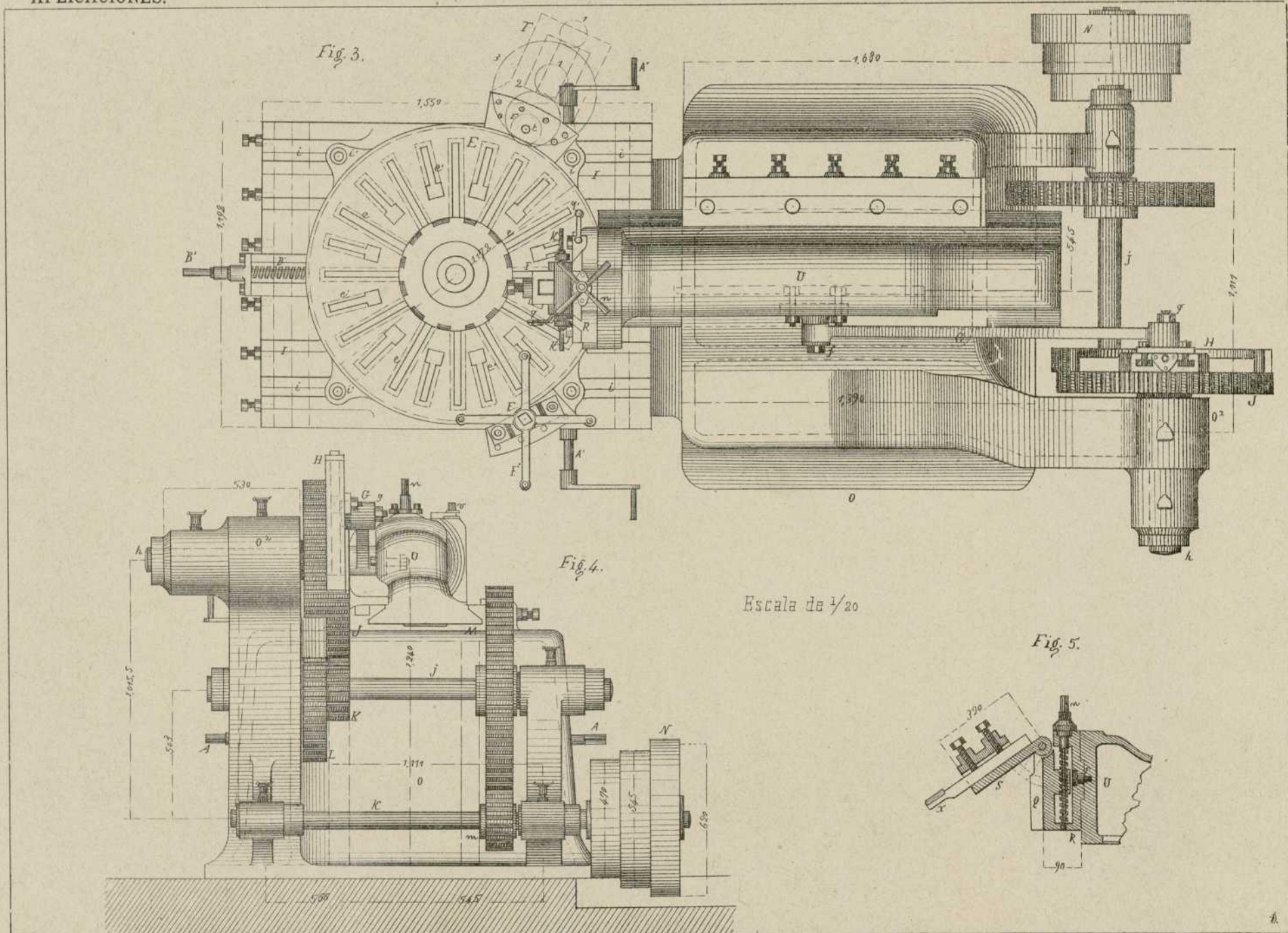
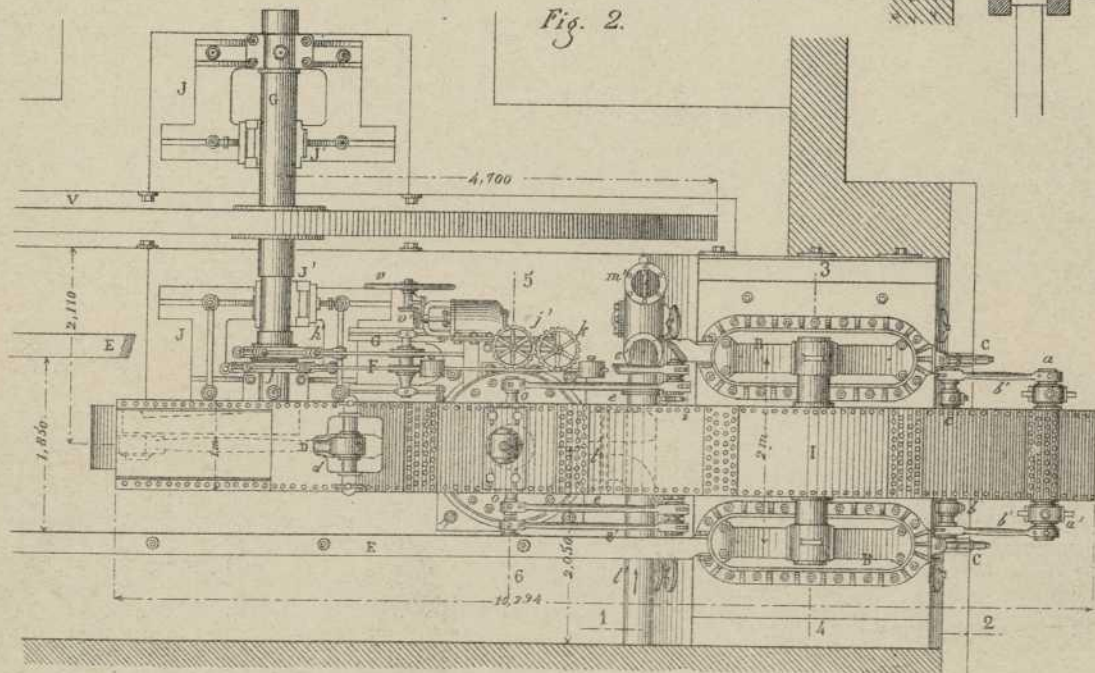
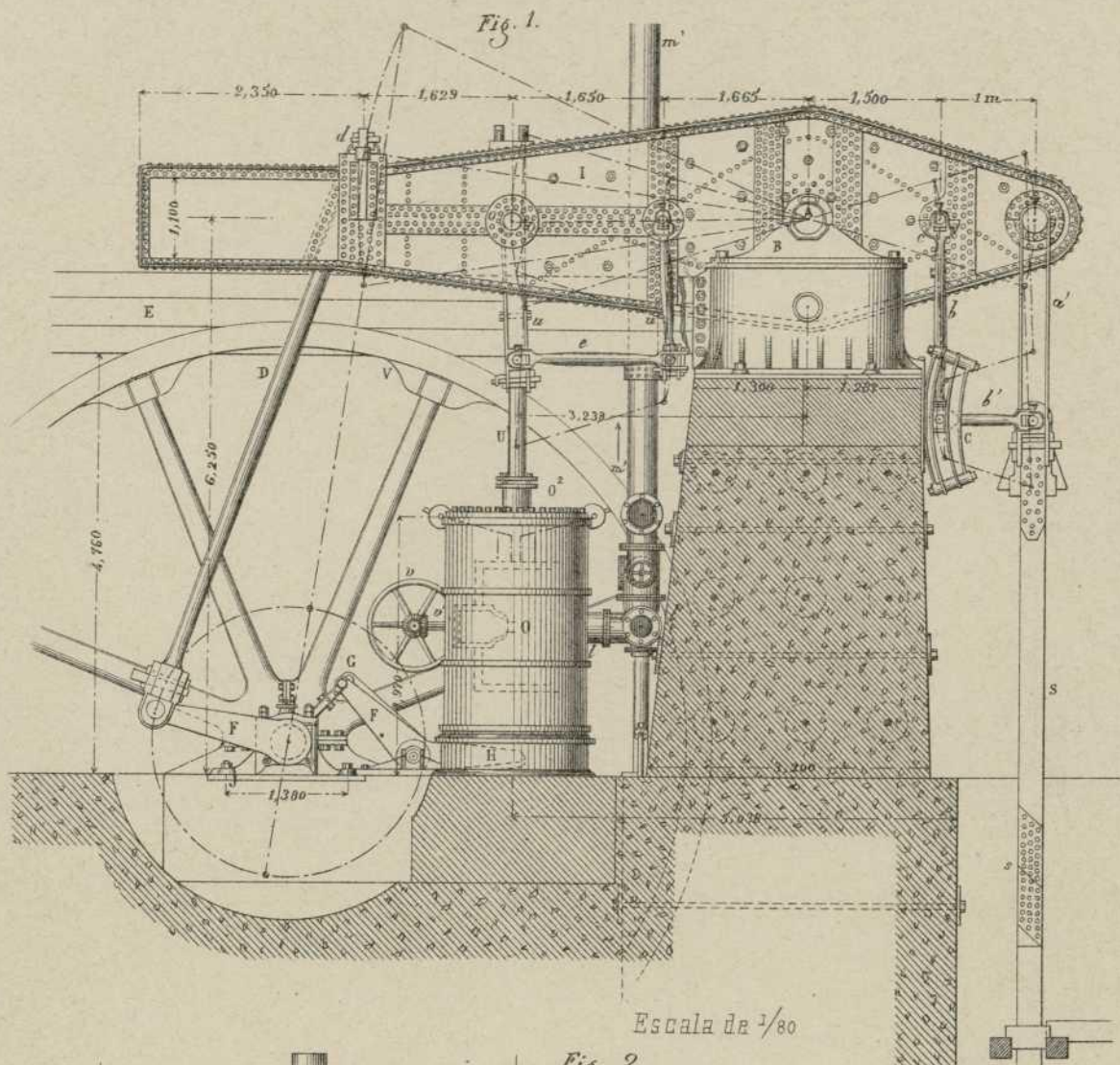


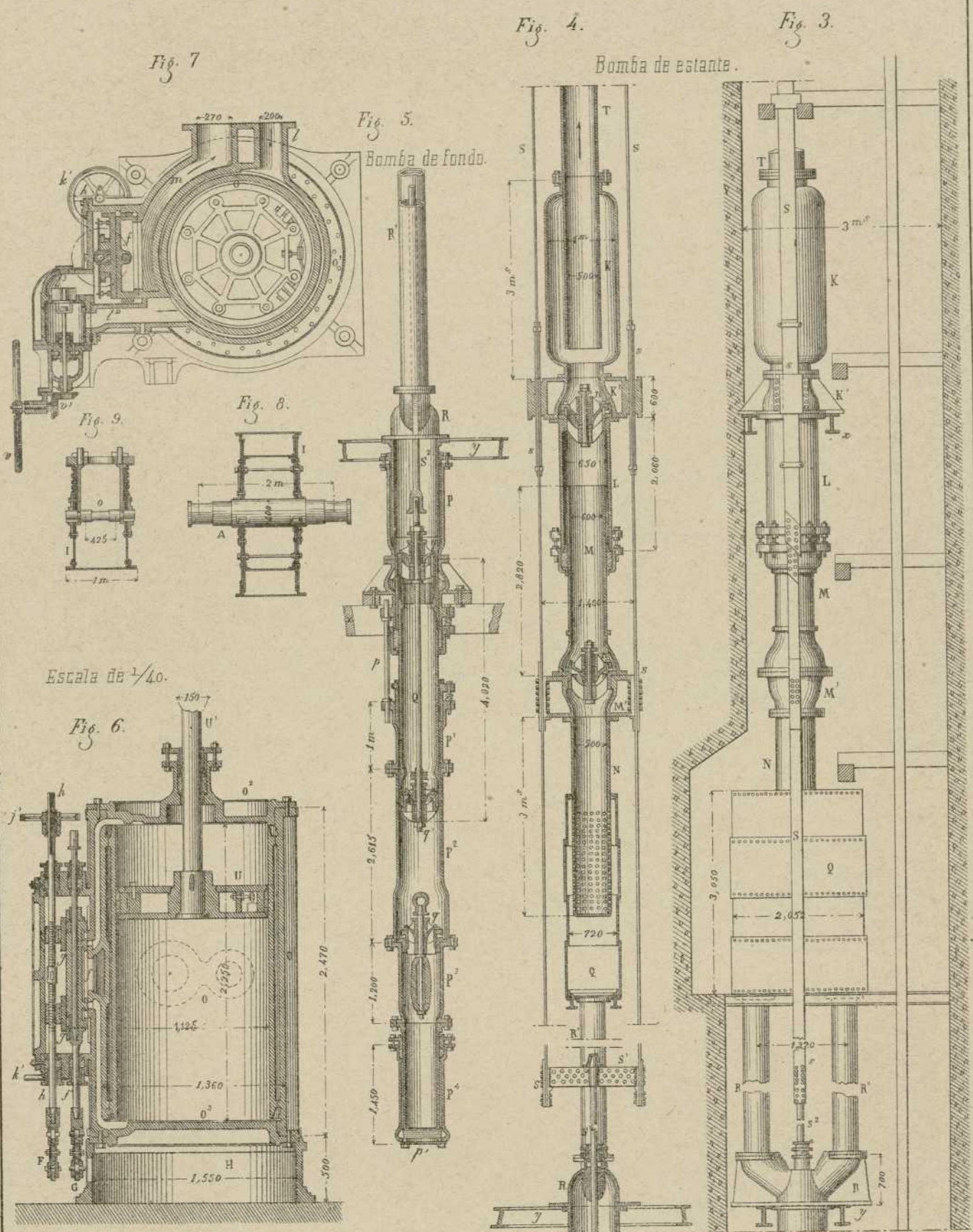
Fig. 7.

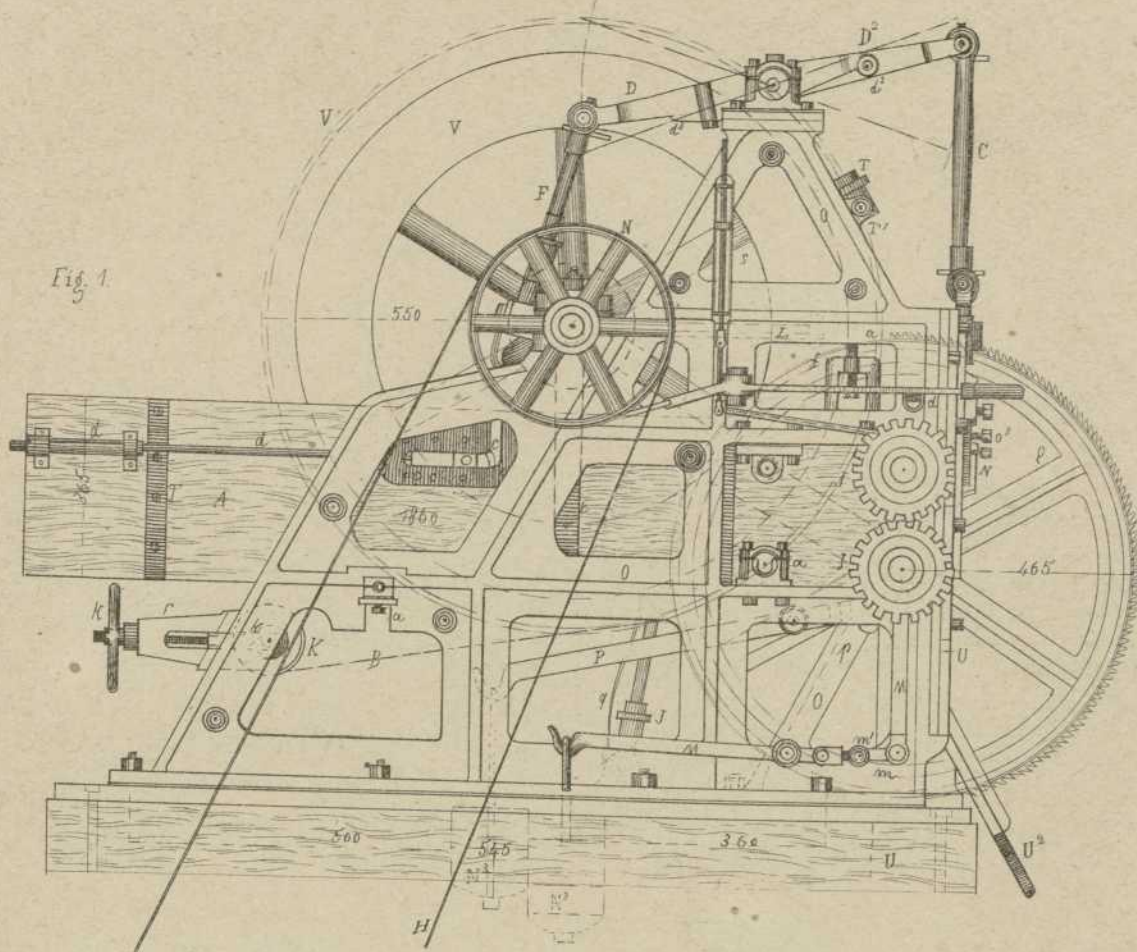












Escala de 1/10.

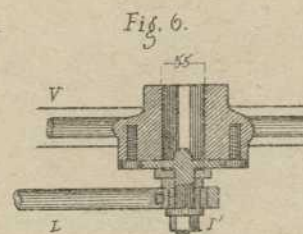
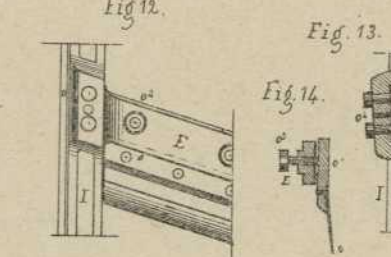
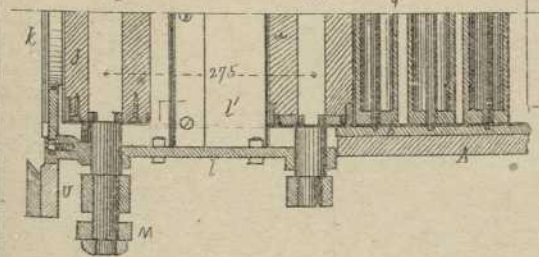
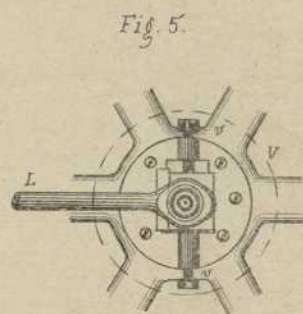
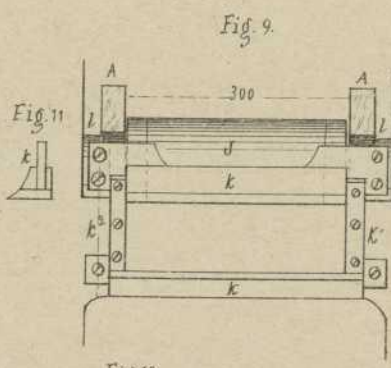
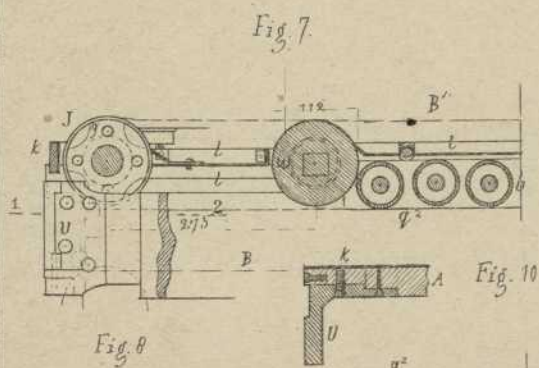


Fig. 2.

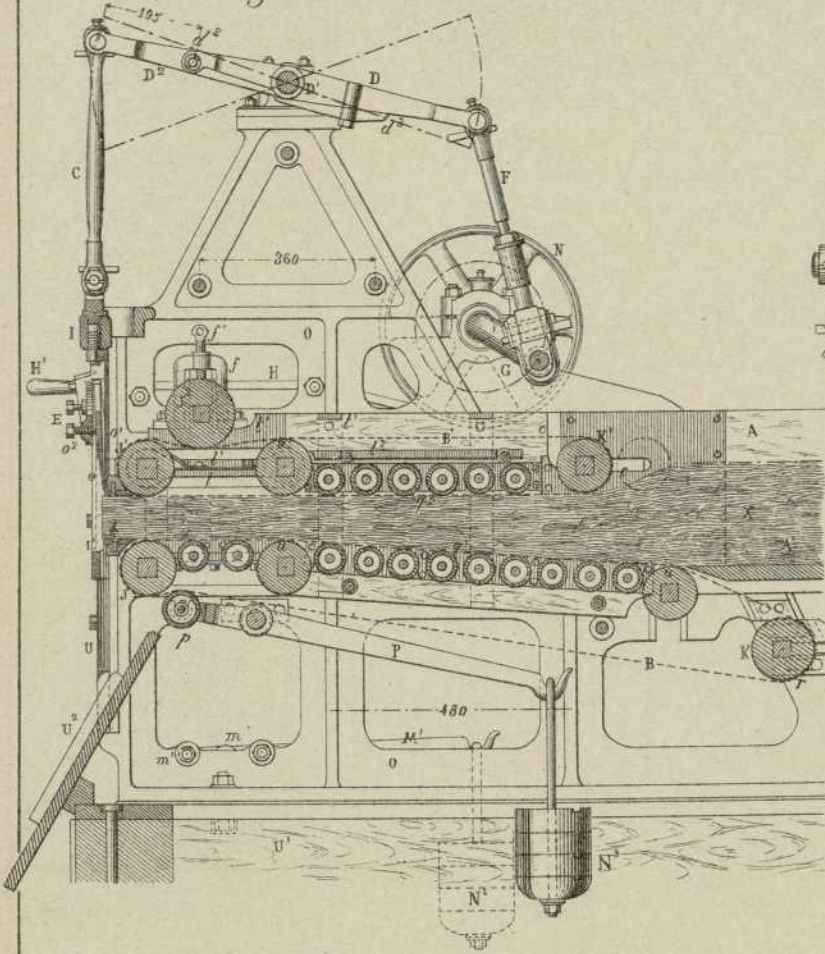
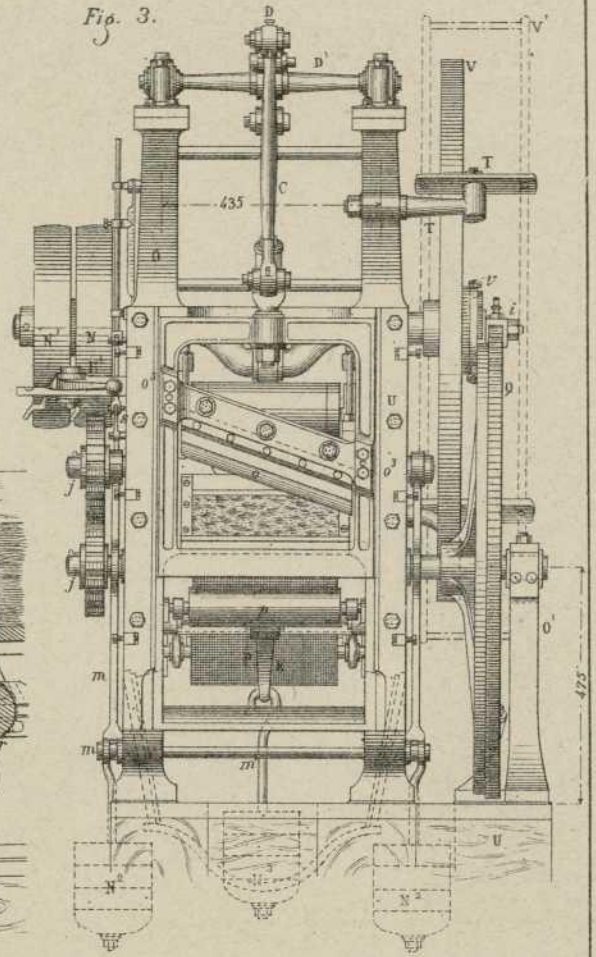
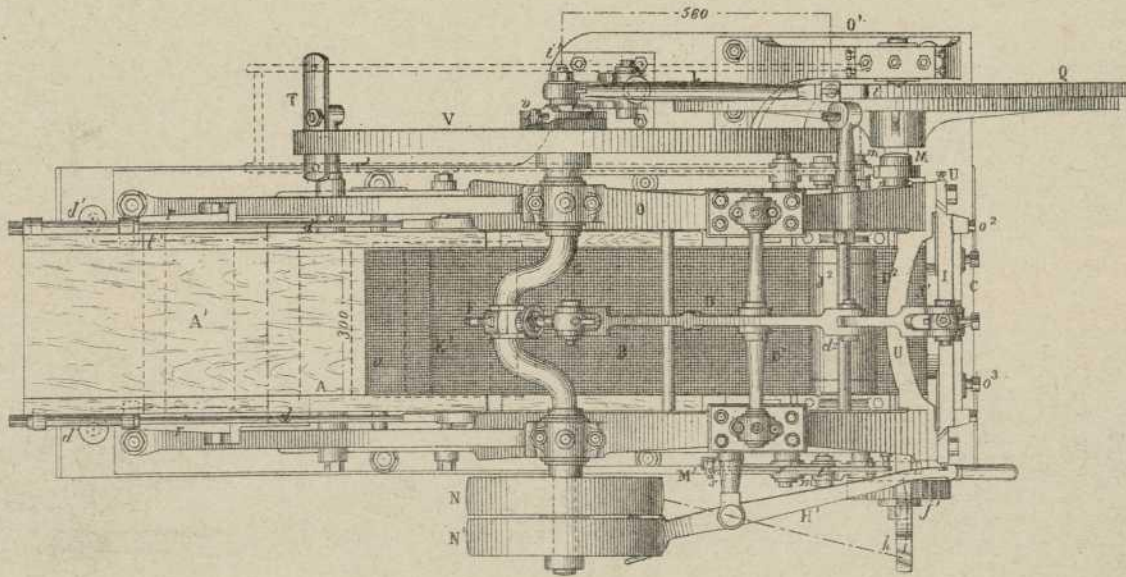


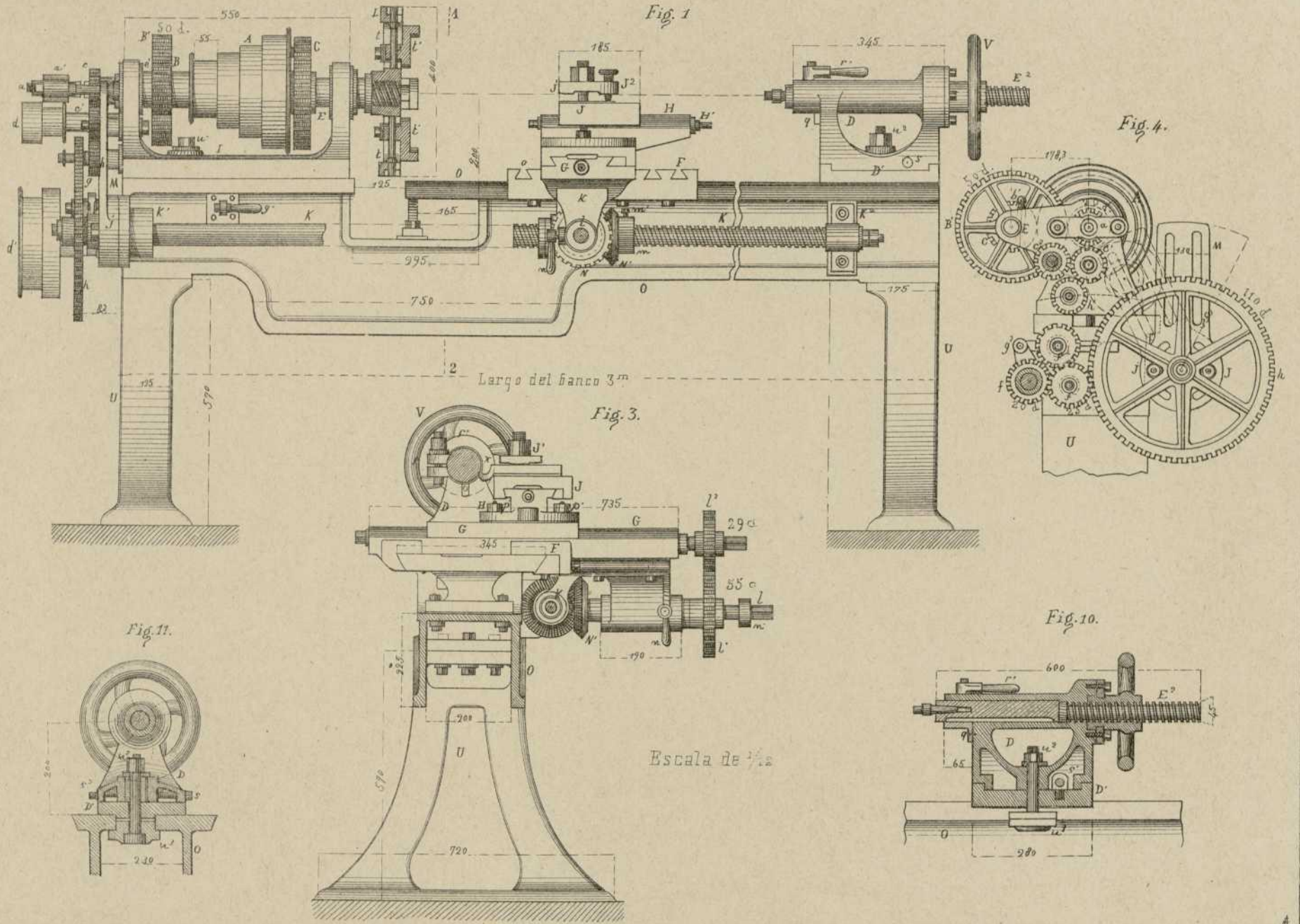
Fig. 3.



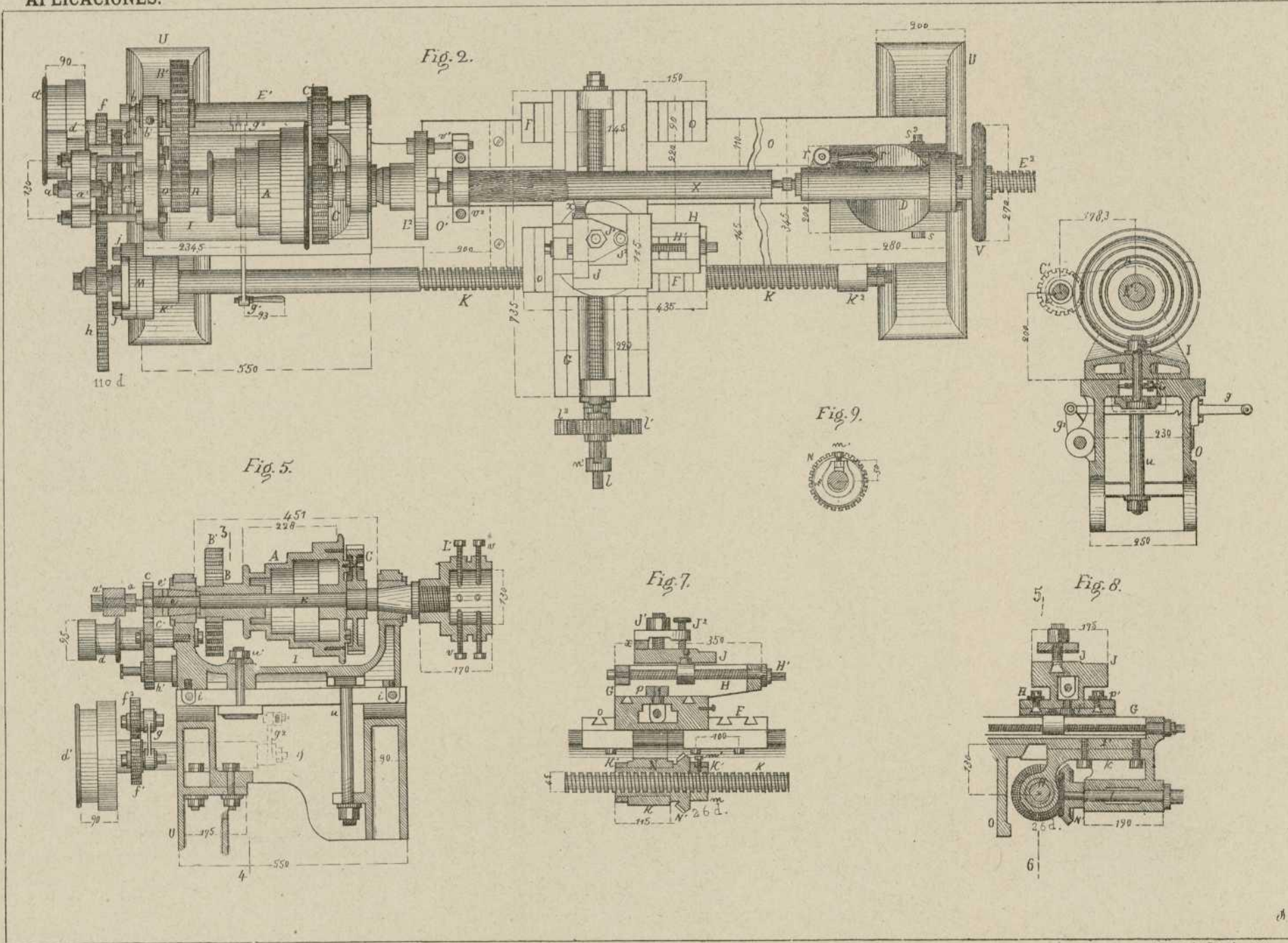
Escala de 1/15.

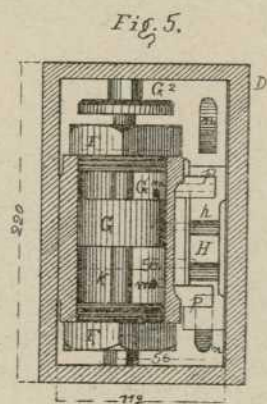
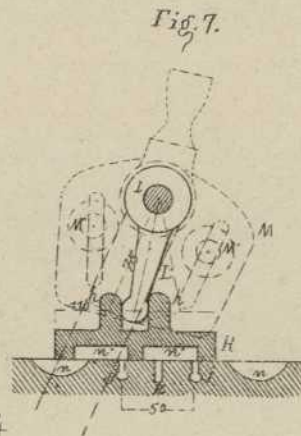
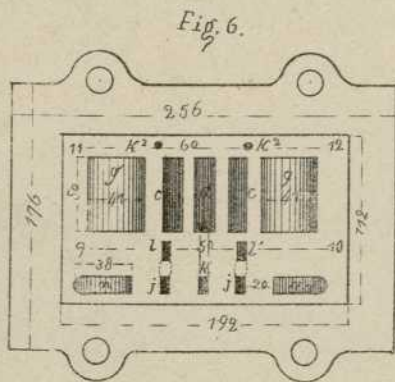
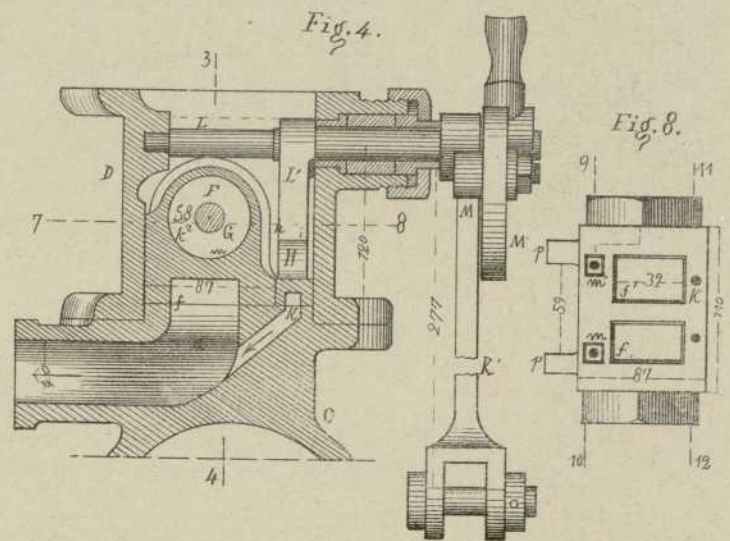
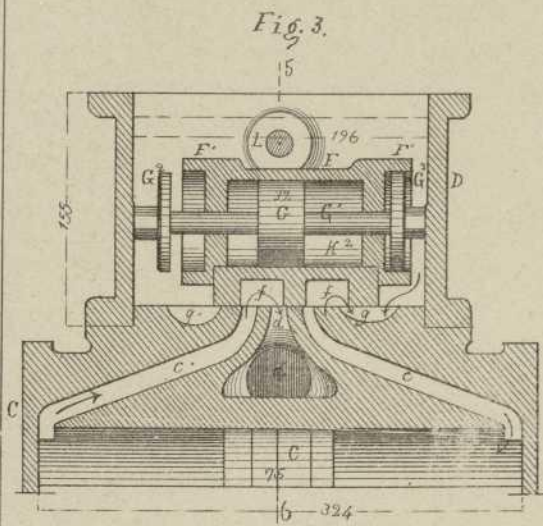
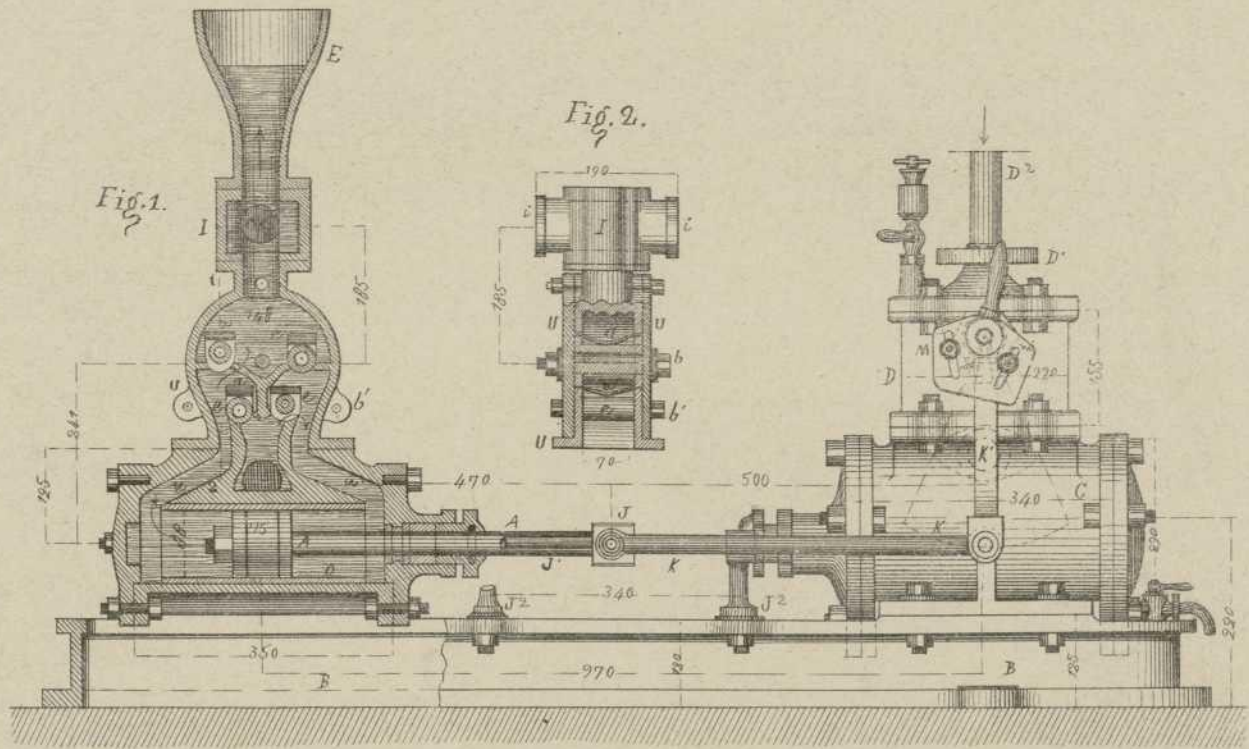
Fig. 4.



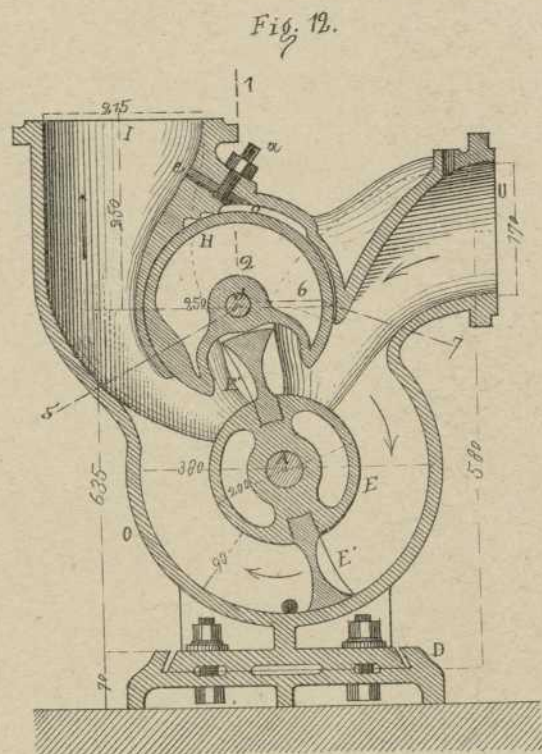
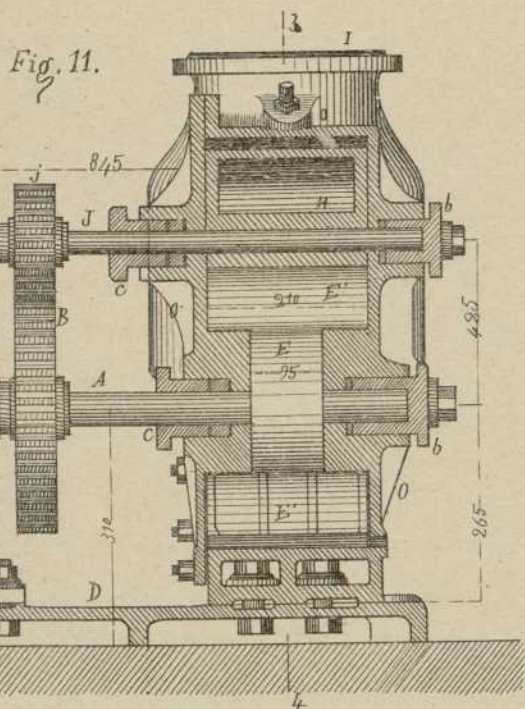
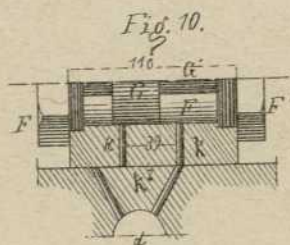
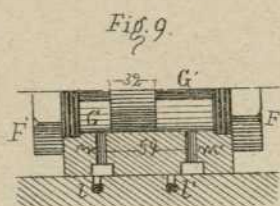


Escala de 1/2





Escala de 1/10 por las Fig. 1, 2 II à 14



Escala de 1/15 por las Fig 3 á 10.

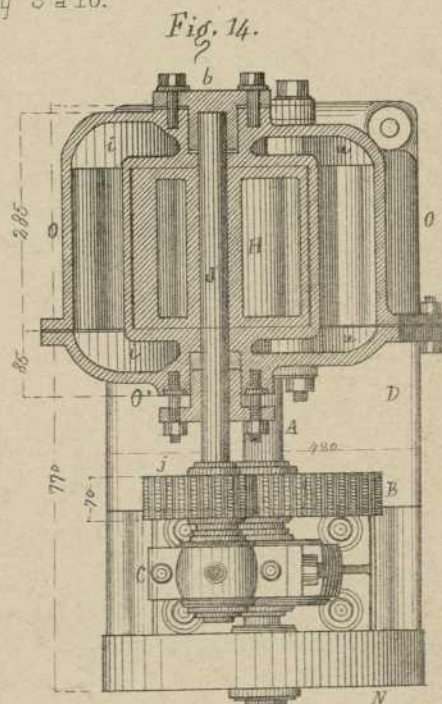
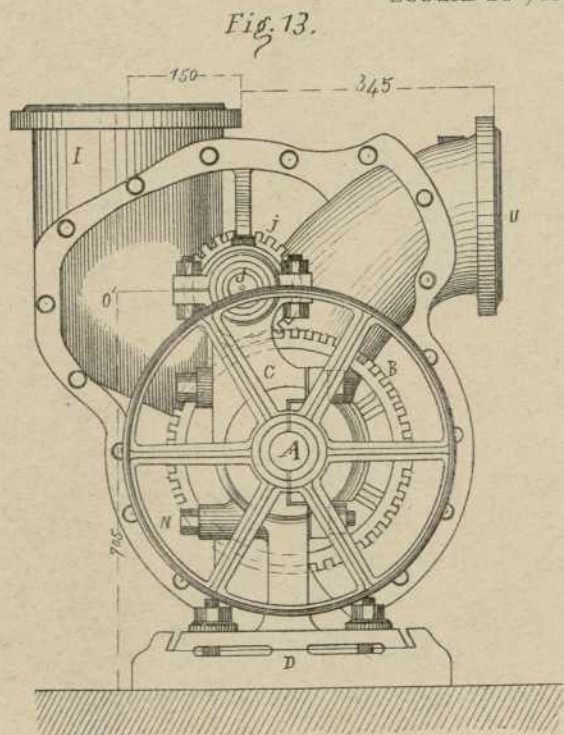


Fig. 3.

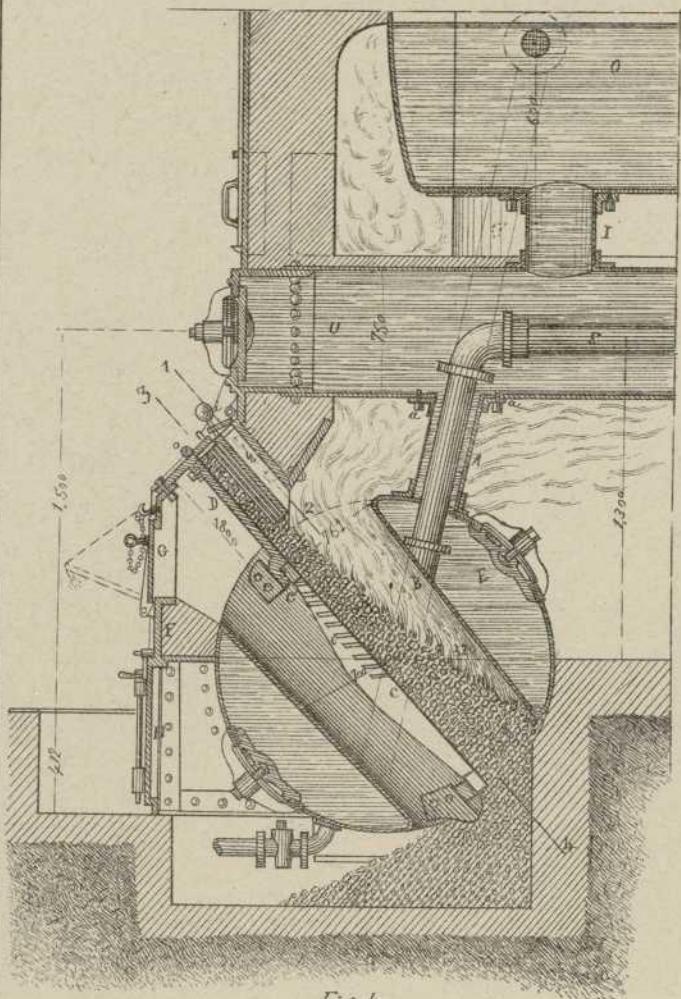
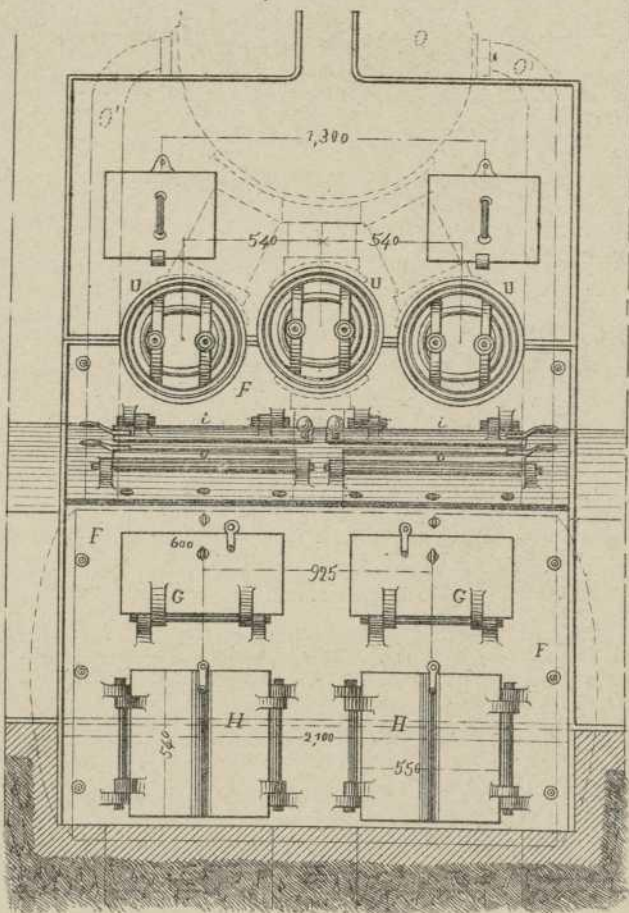


Fig. 5.



Escala de 1/30

Fig. 4.

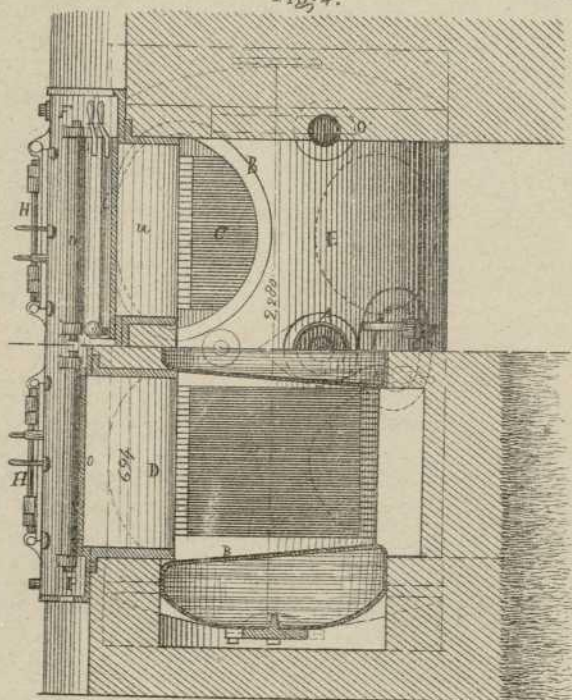
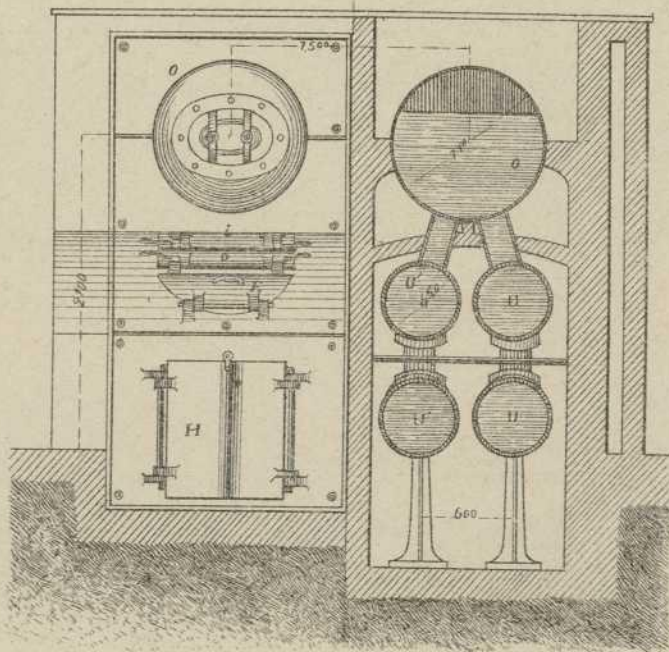
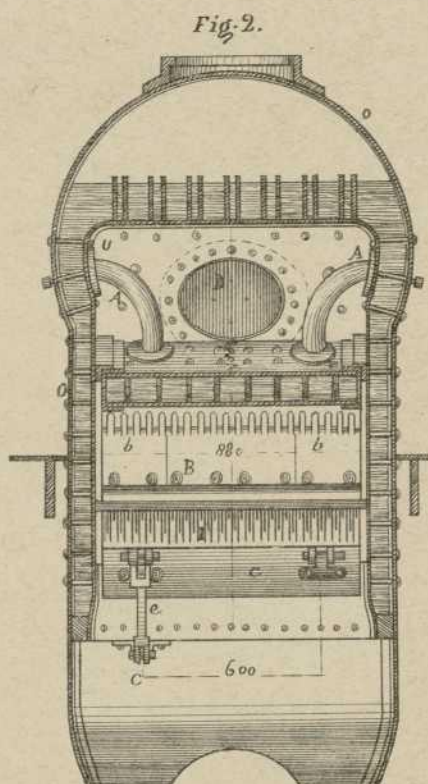
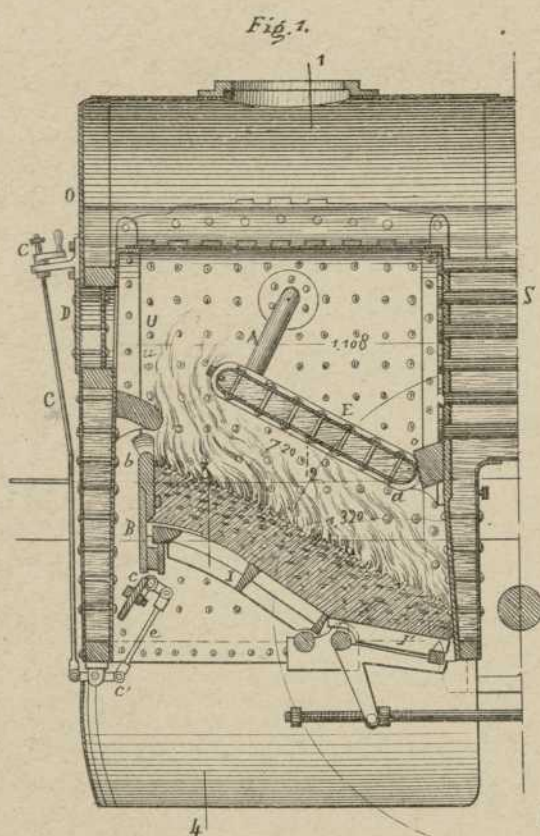


Fig. 8.





Escala de 1/50

Fig. 6.

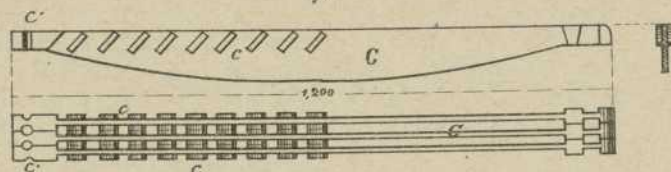
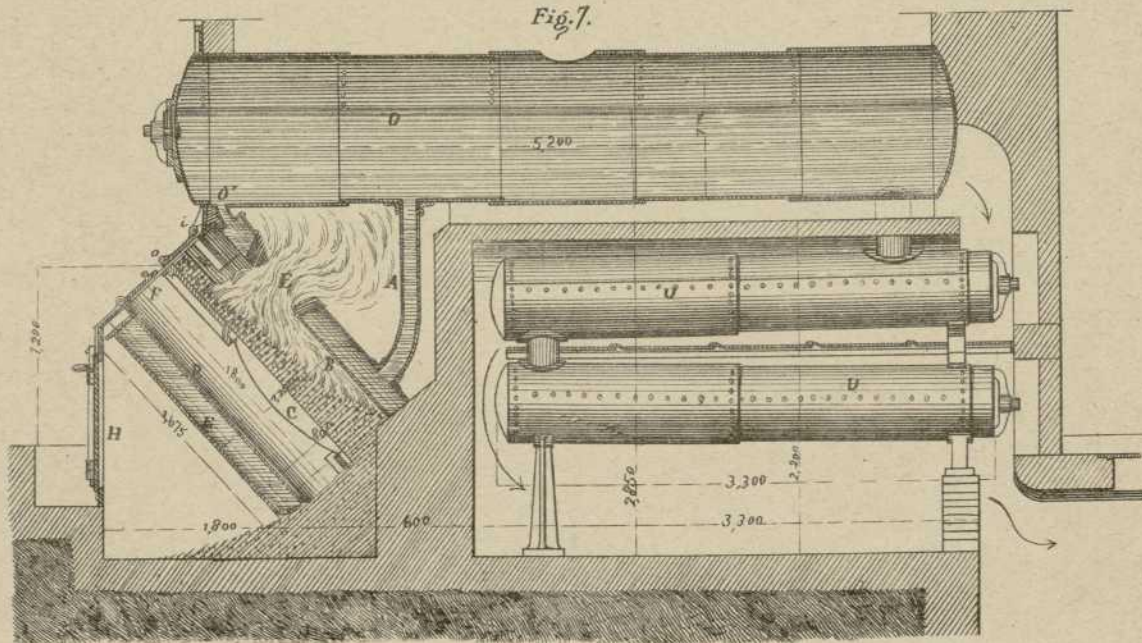
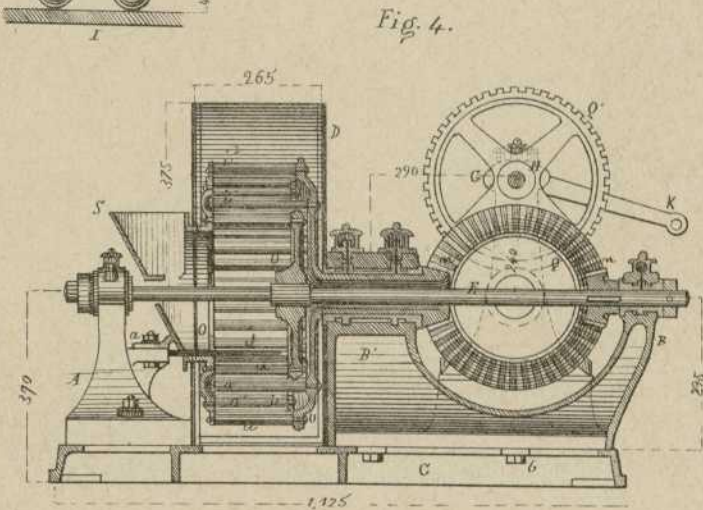
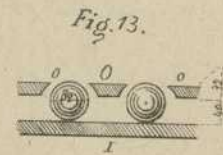
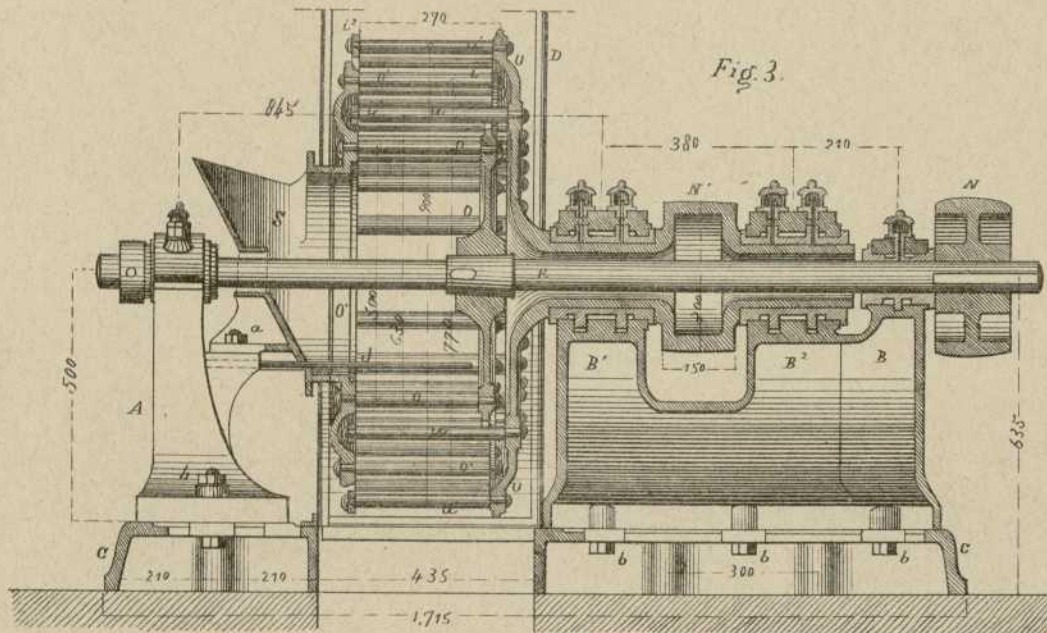
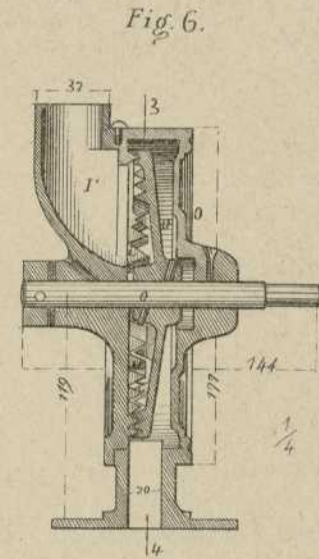
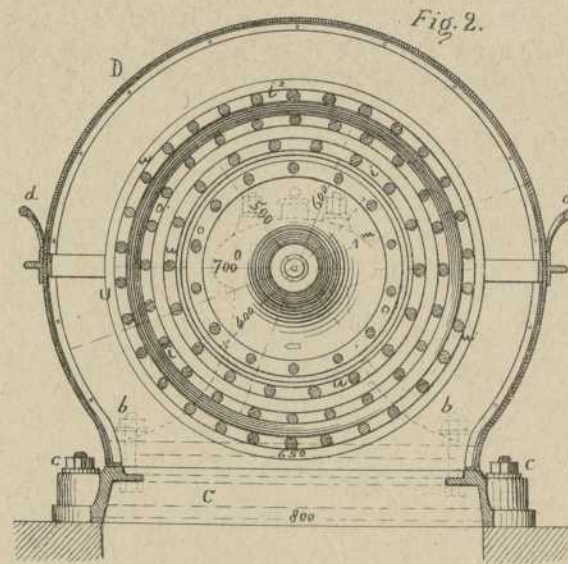
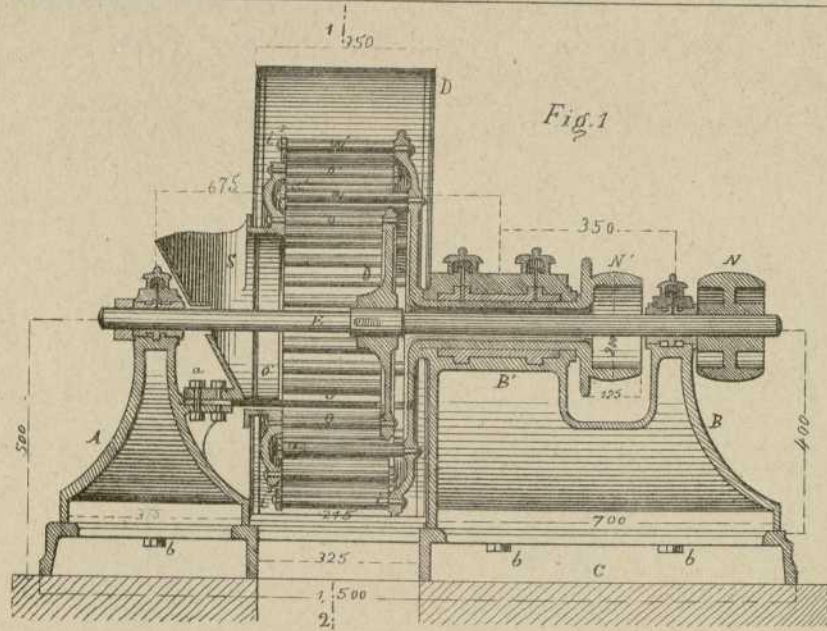


Fig. 7.





Escala de 1/4 por las Fig. 1 à 5.

Fig. 5.

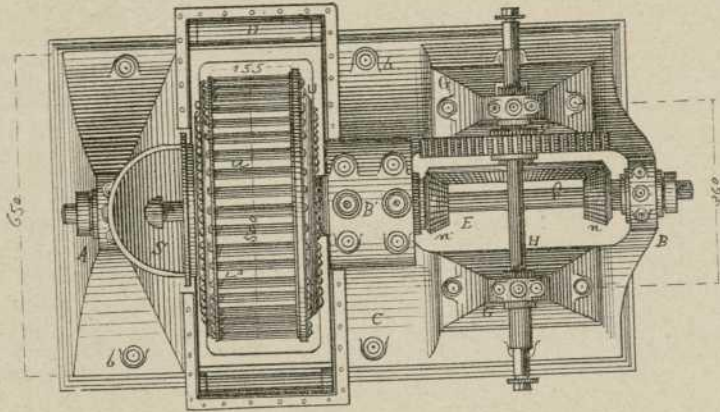


Fig. 7.

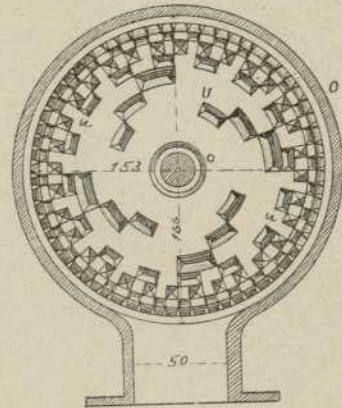


Fig. 8.

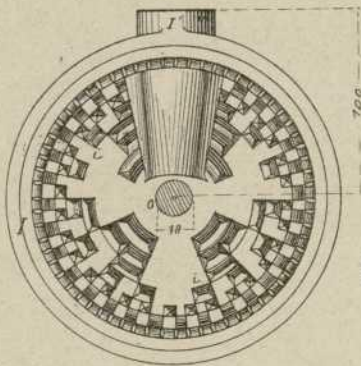


Fig. 9.

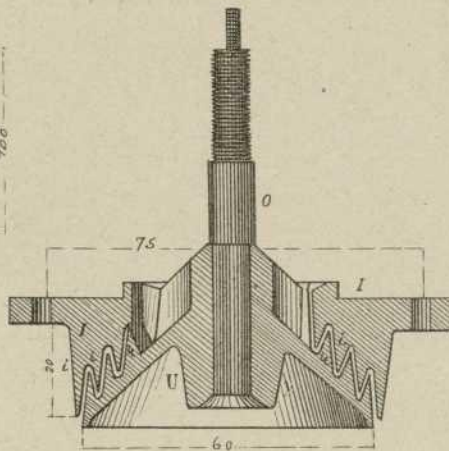


Fig. 10.

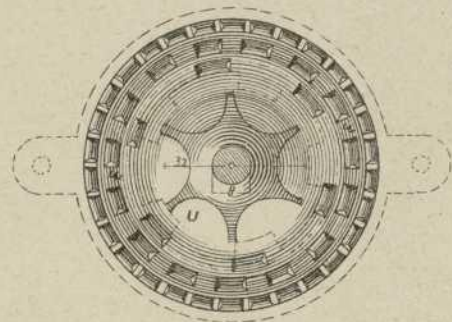


Fig. 11.

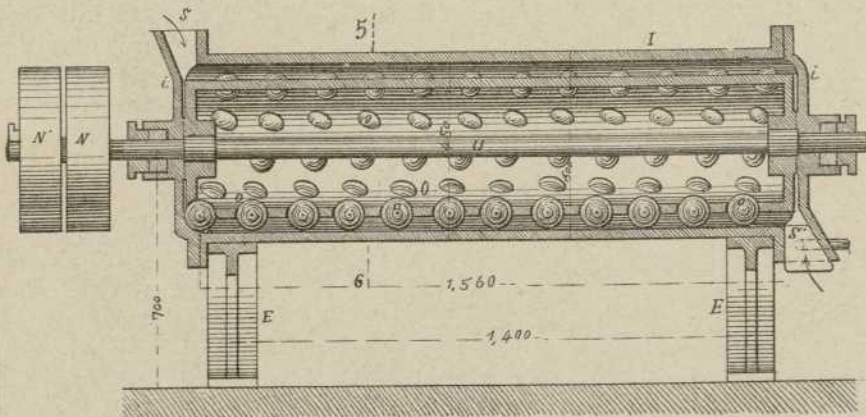
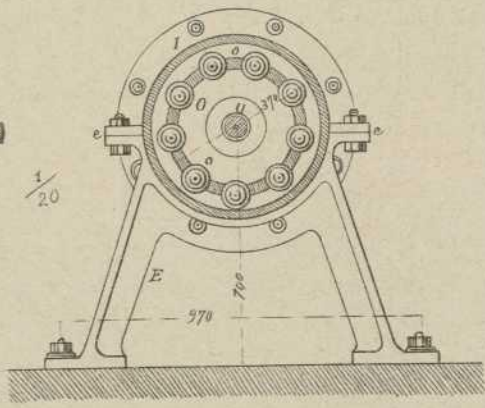
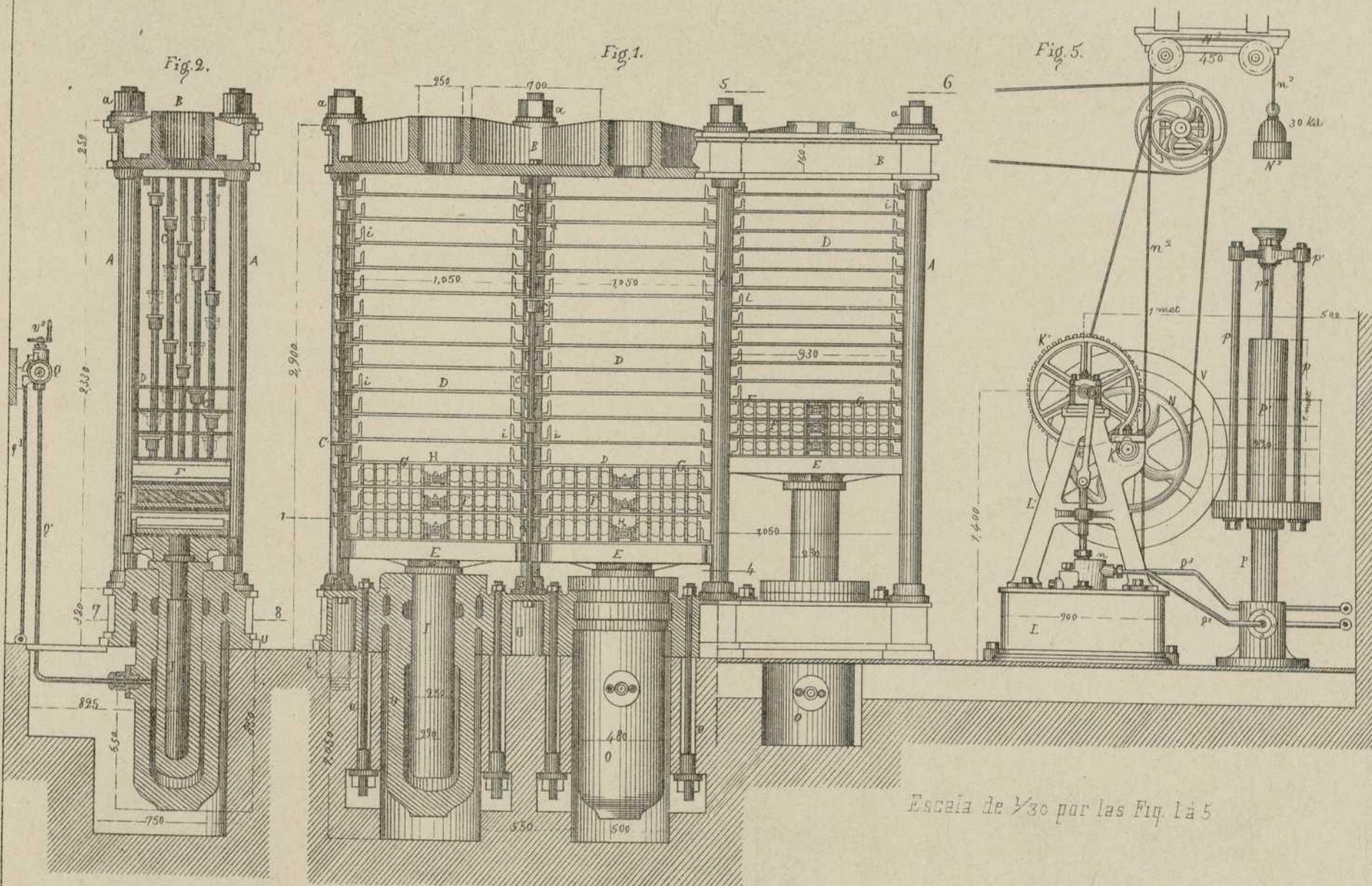
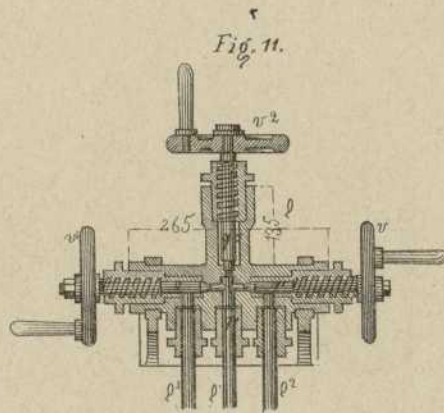
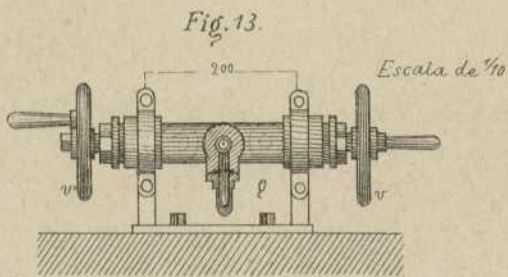
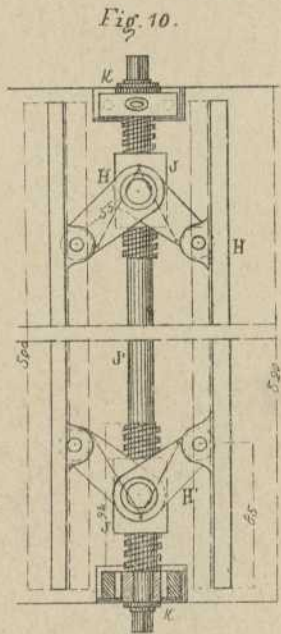
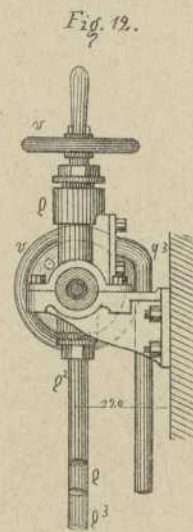
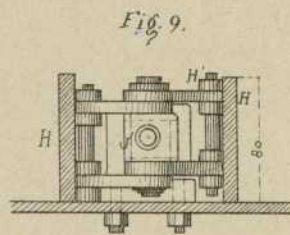
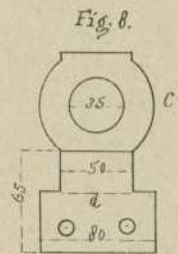
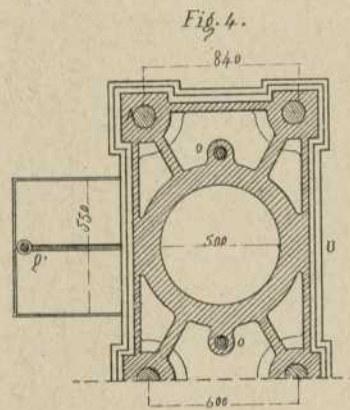
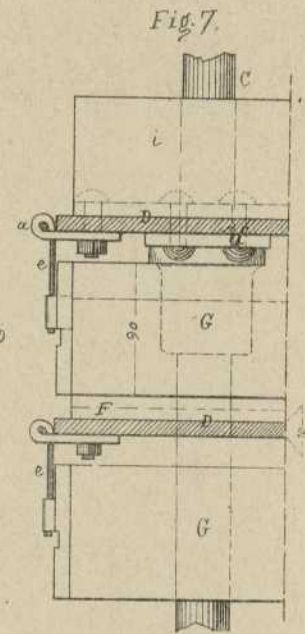
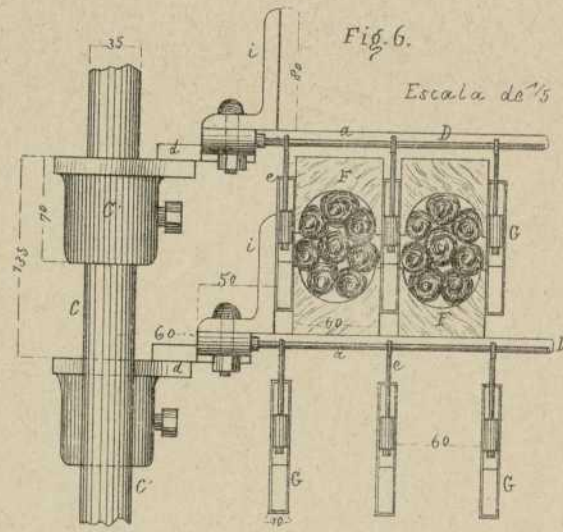
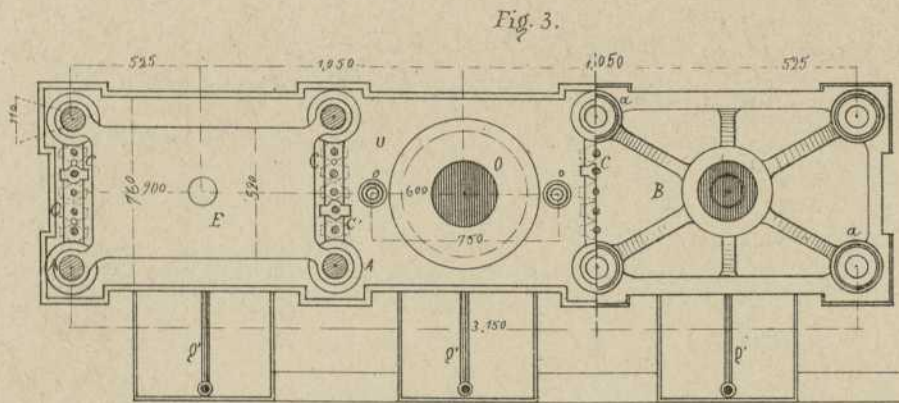


Fig. 12.





Escala de 1/30 por las Fig. 1 a 5



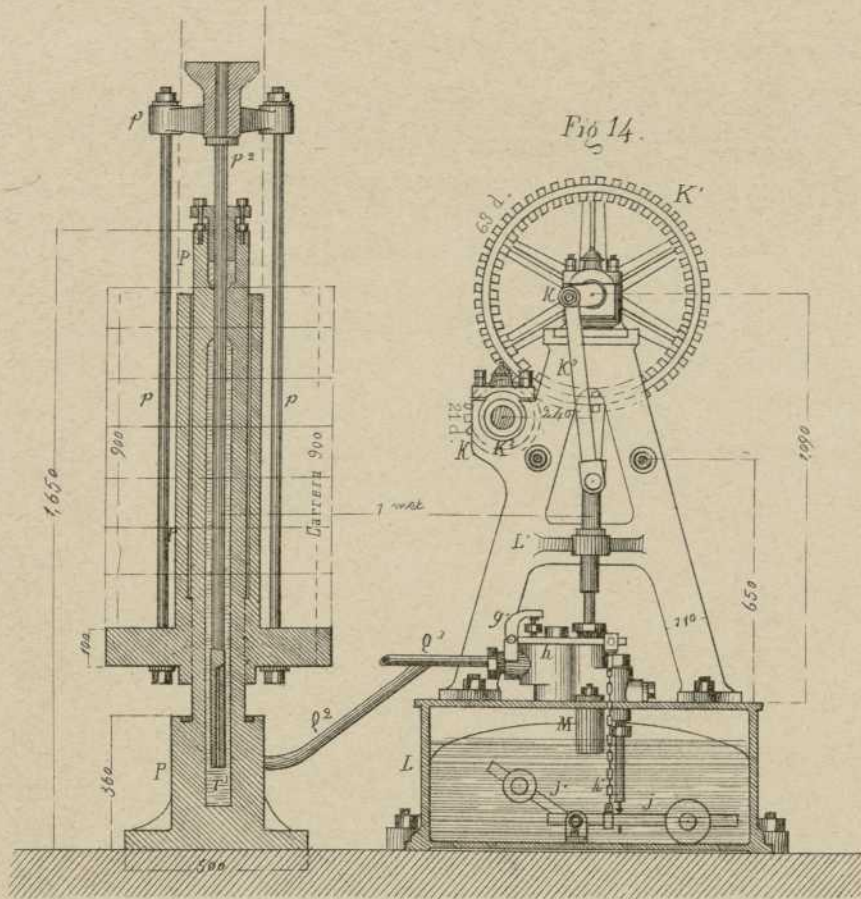
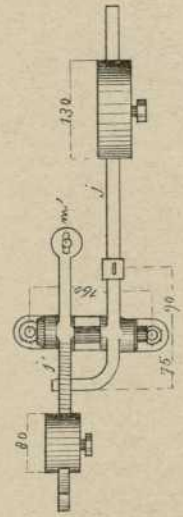


Fig. 19.



Escala de 1/10 por las Fig 18 à 21.

Fig. 15.

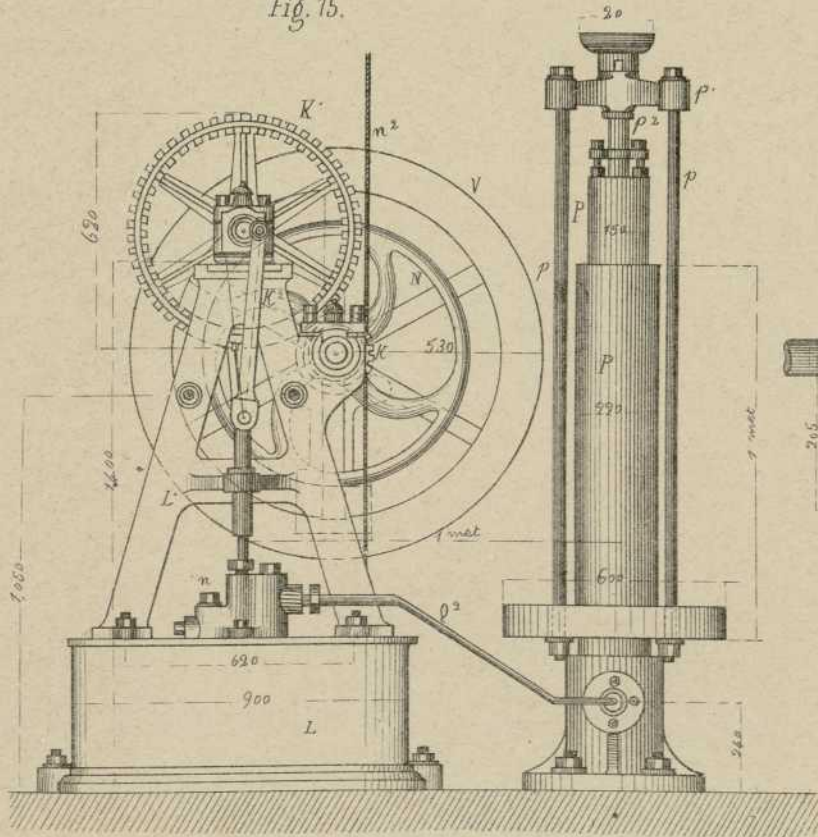
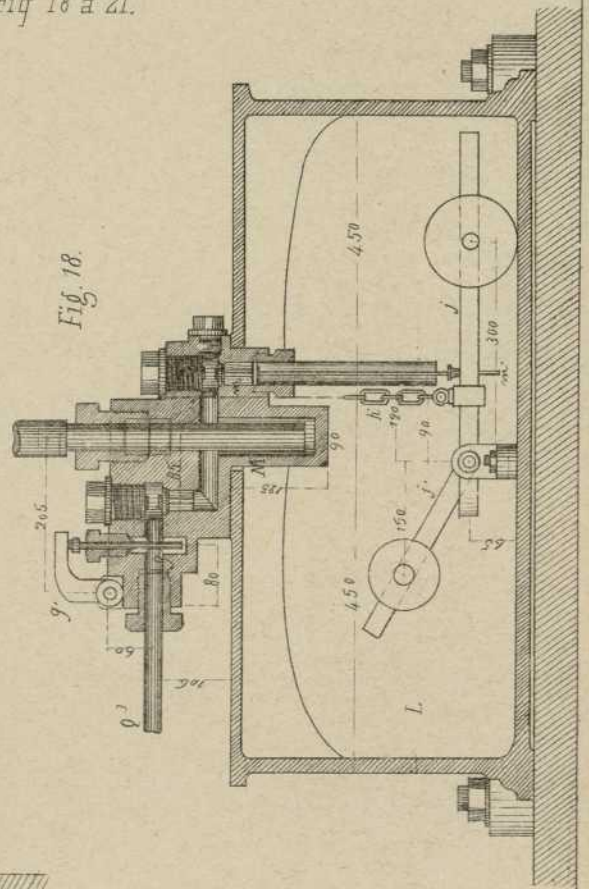
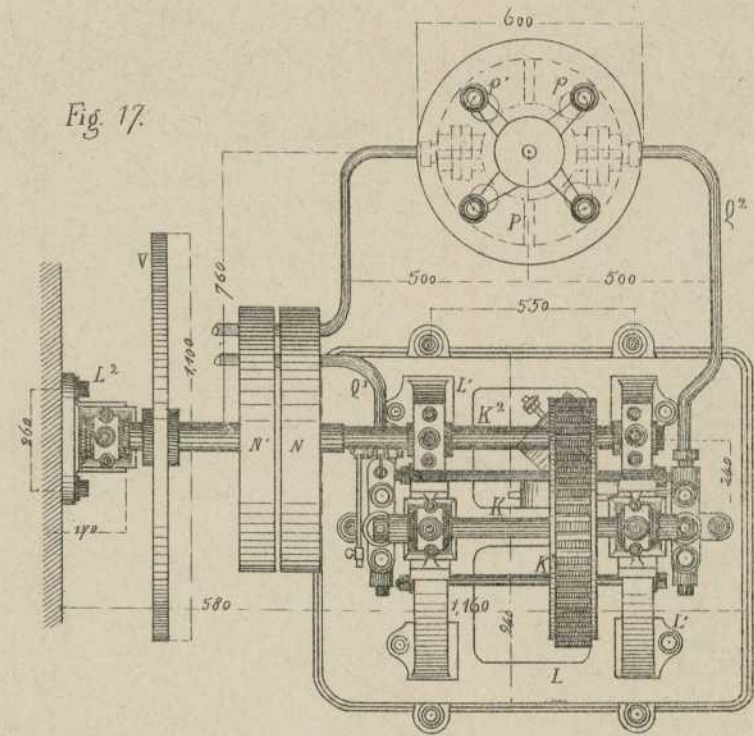
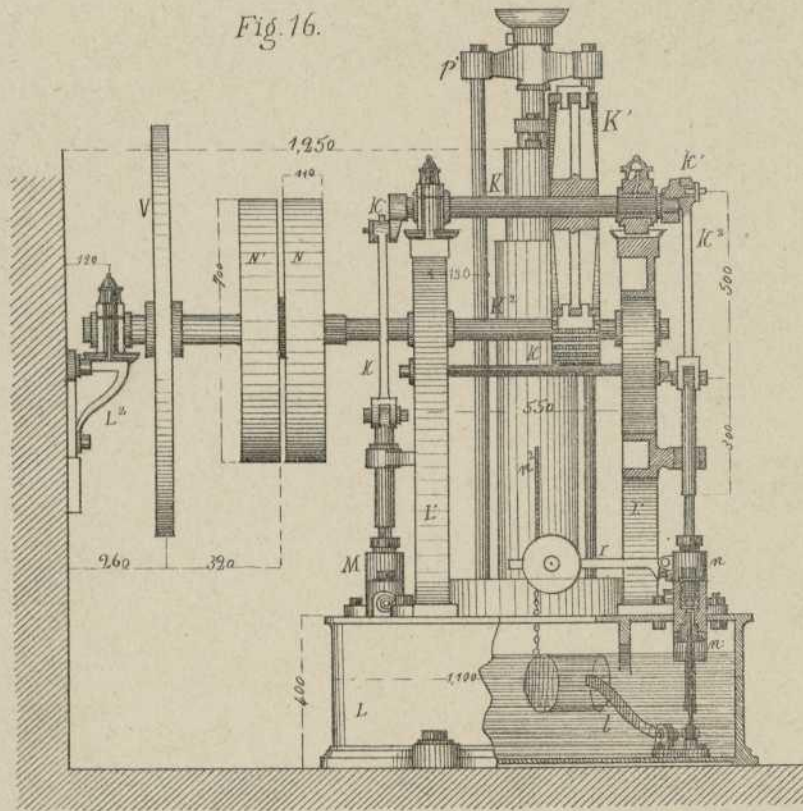


Fig. 18.





Escala de 1/20 por las Fig 14 á 17.

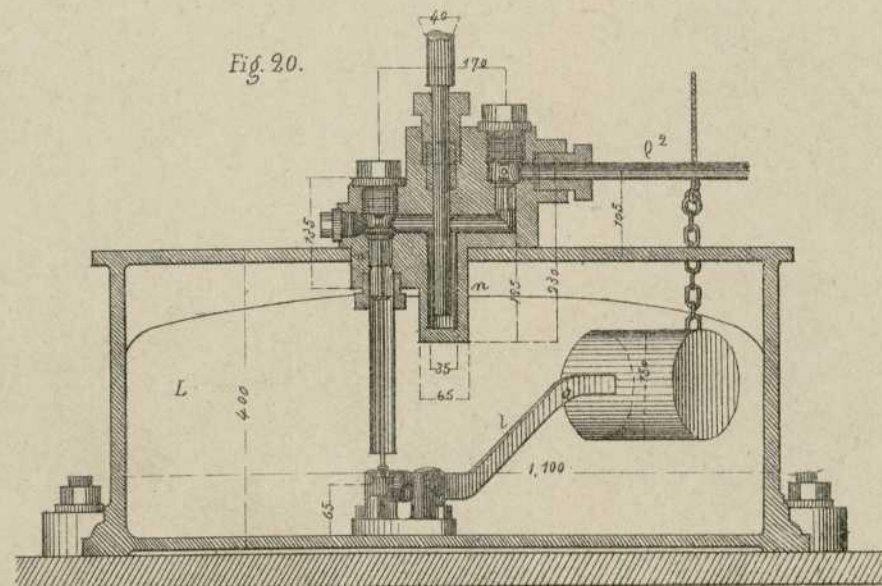
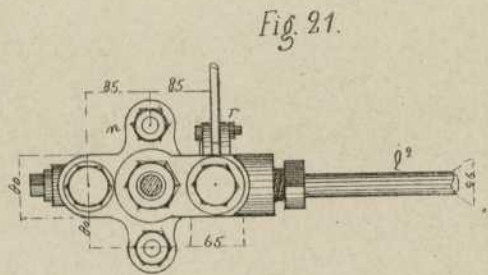


Fig. 1.

Corte longitudinal 1-2

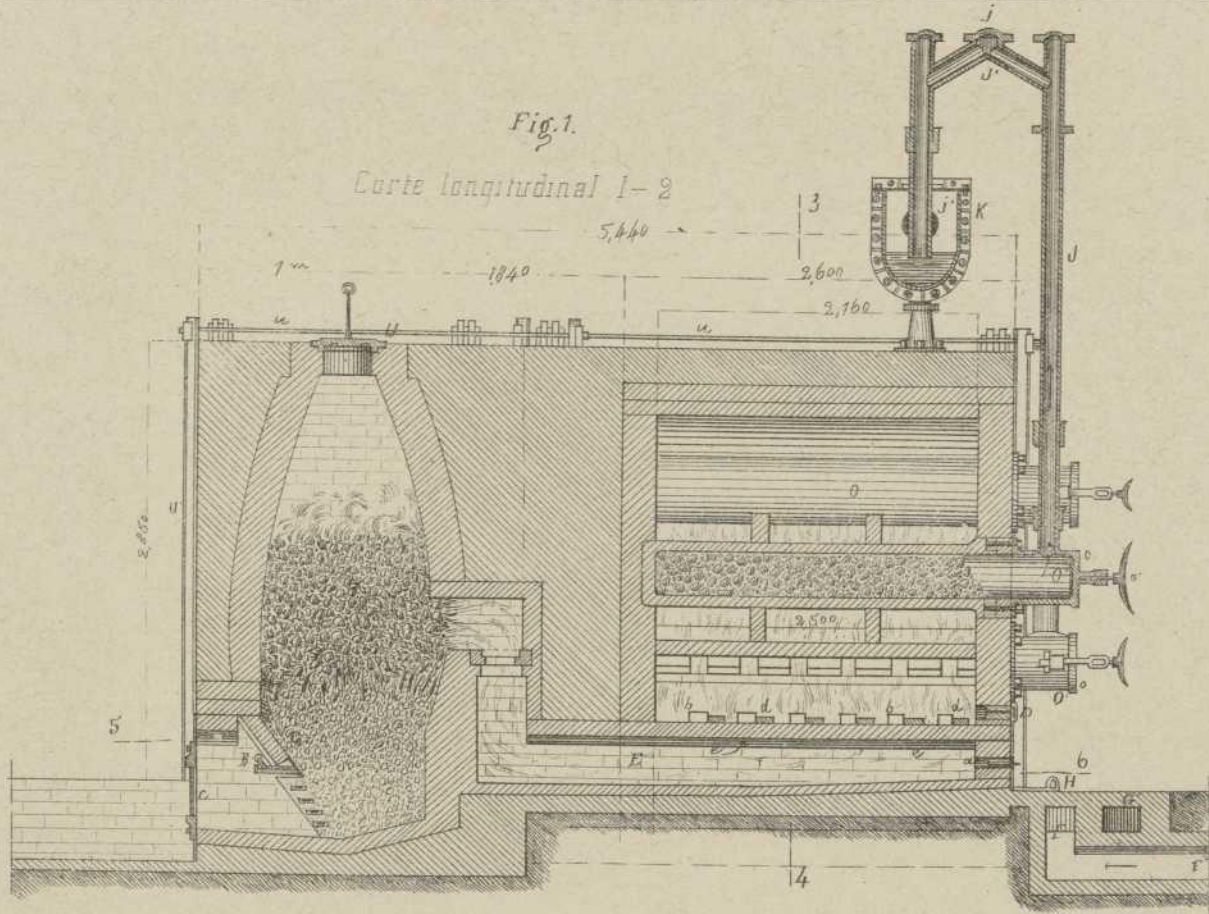


Fig. 3.

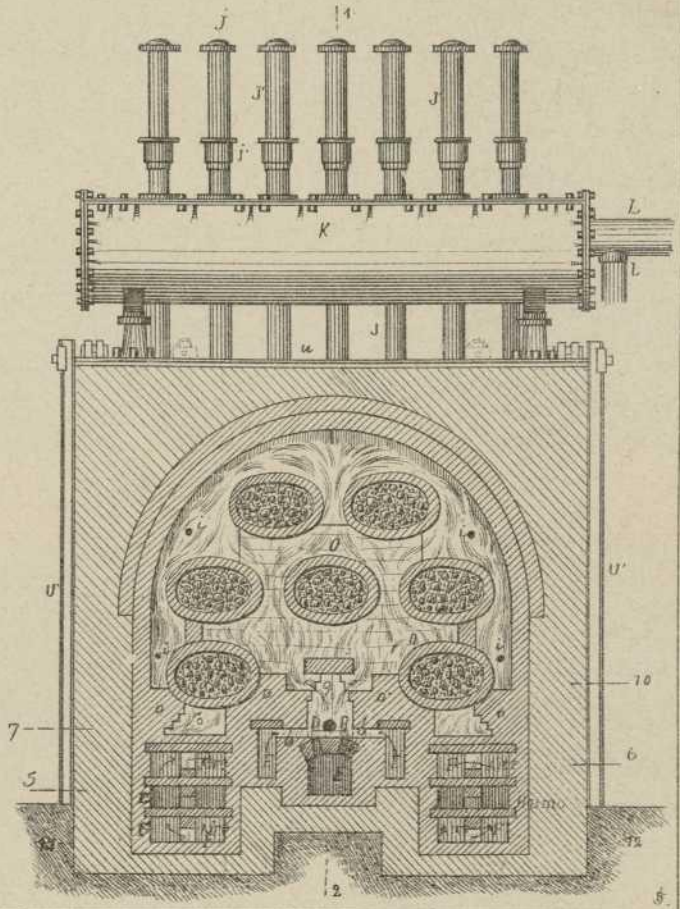


Fig. 2.

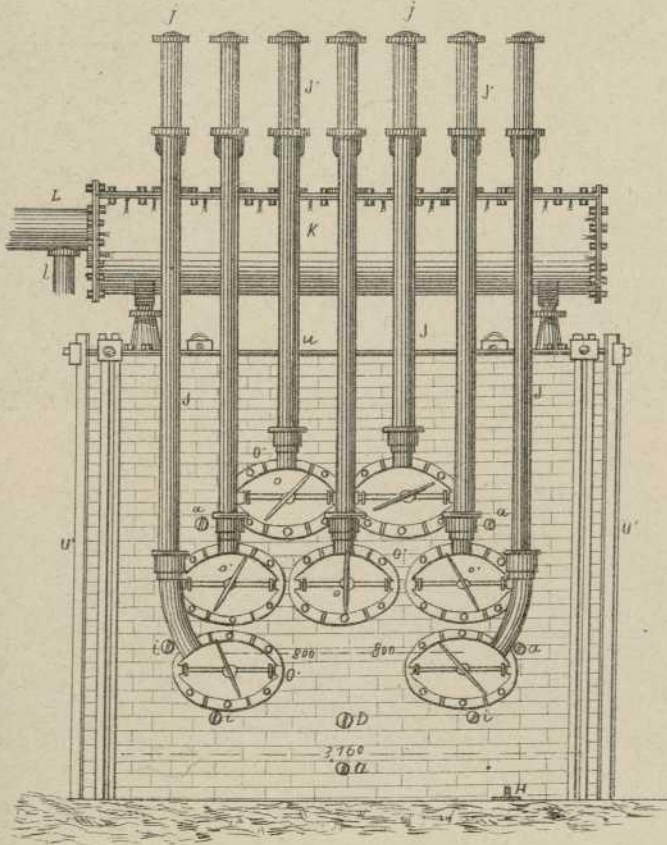
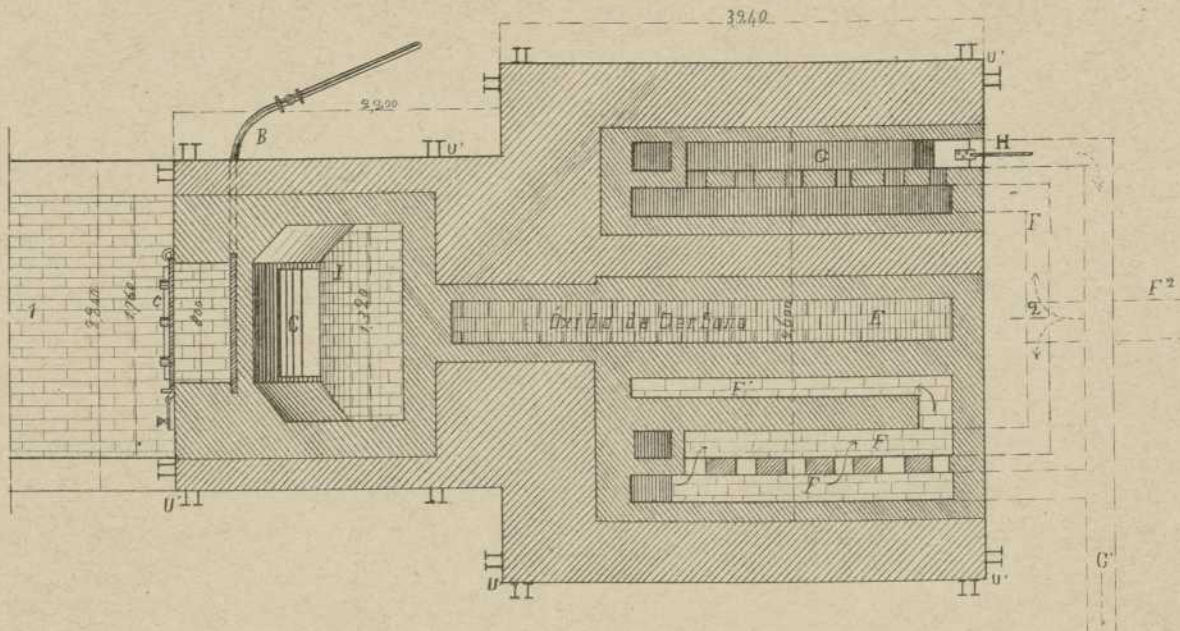
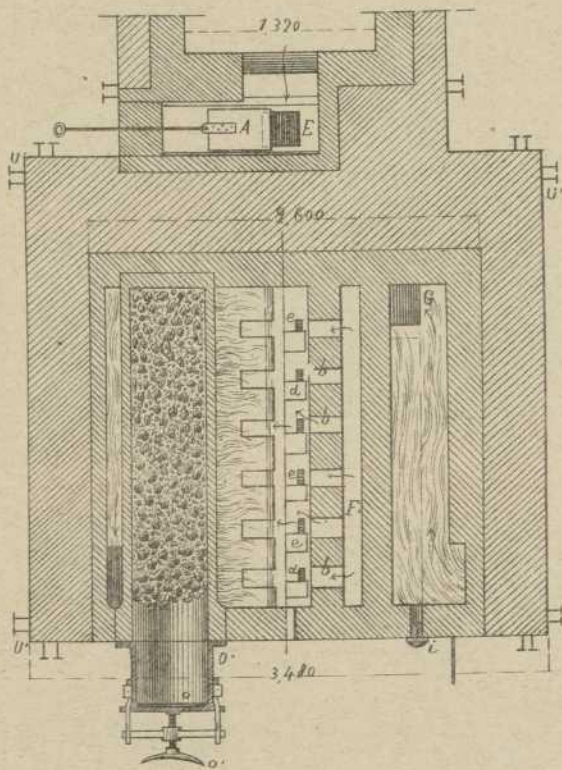


Fig. 4. Corte horizontal 5-6



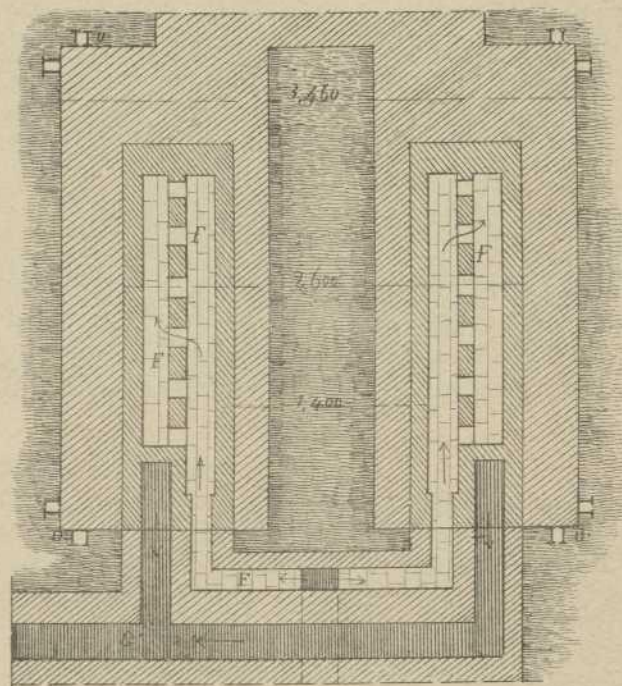
Corte 7-8-9-10

Fig. 5.



Corte 11-12

Fig. 6.

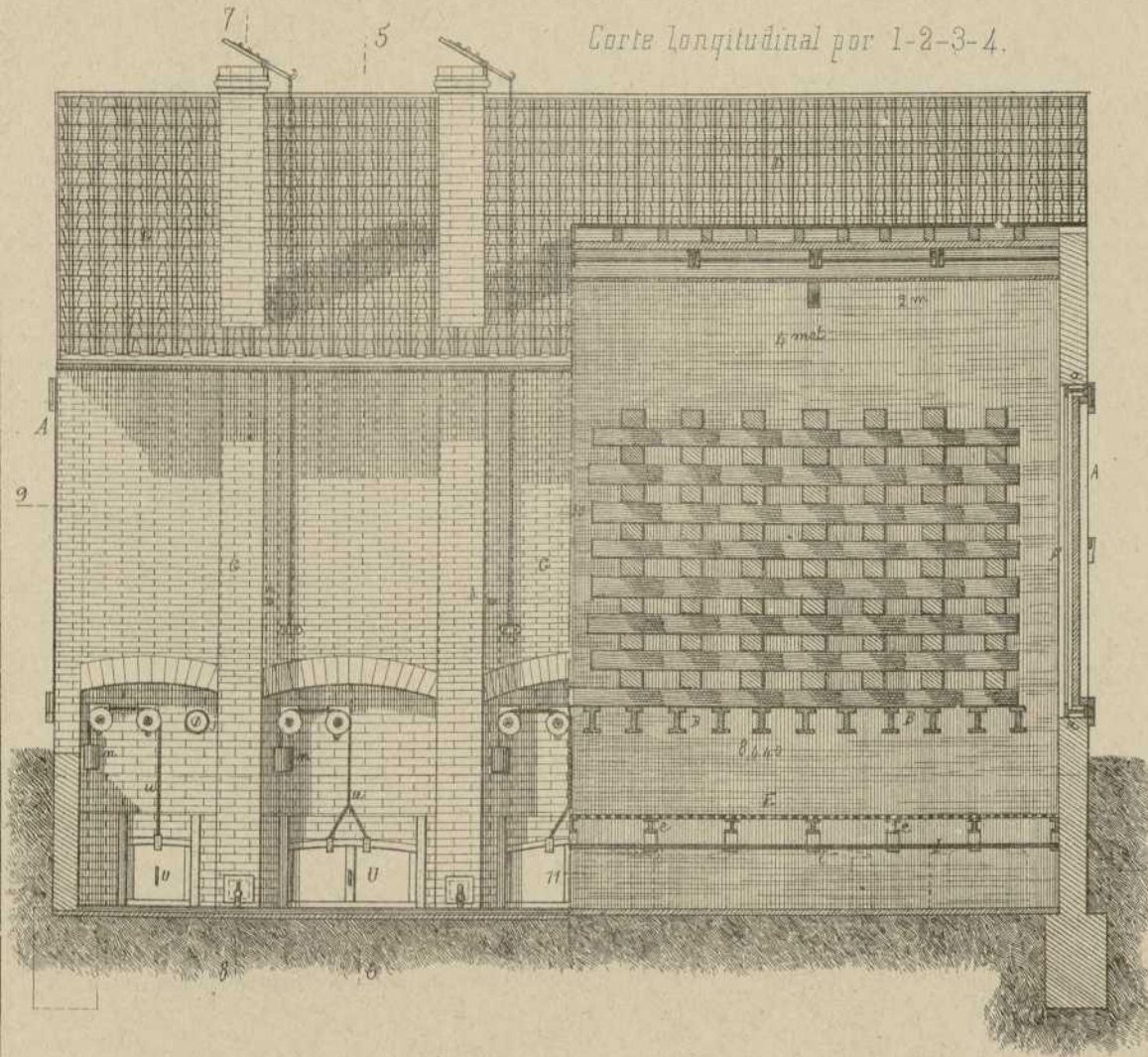


Escala de 1/50

Visto de frente.

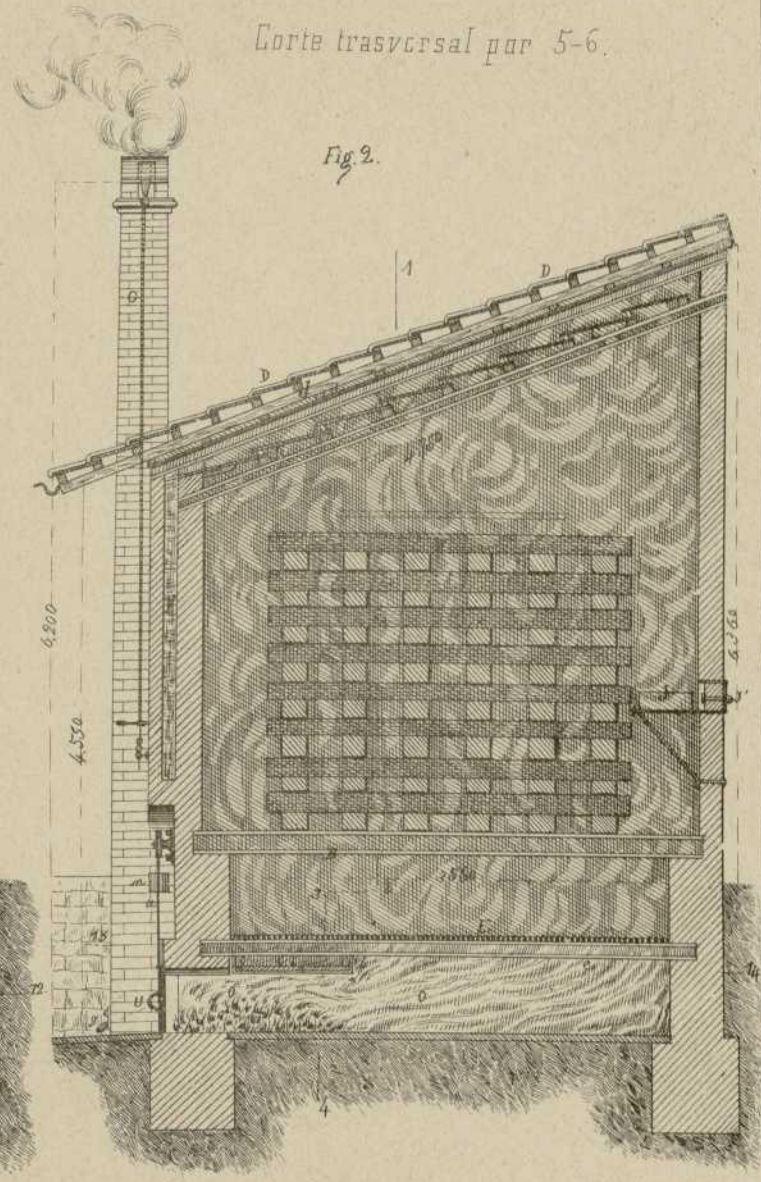
Fig. 1.

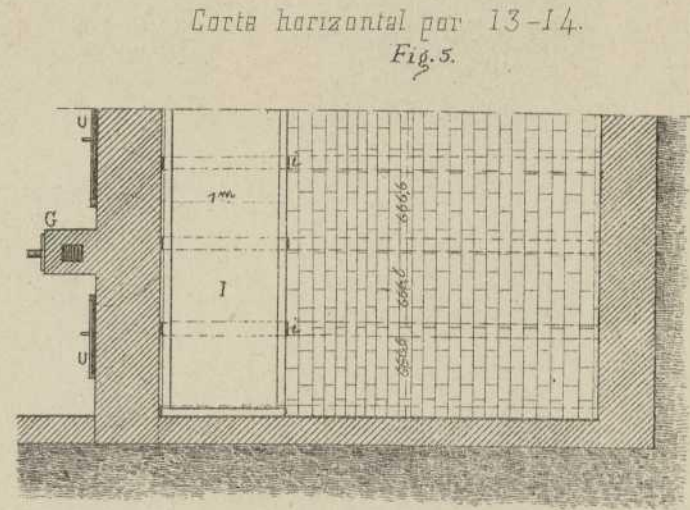
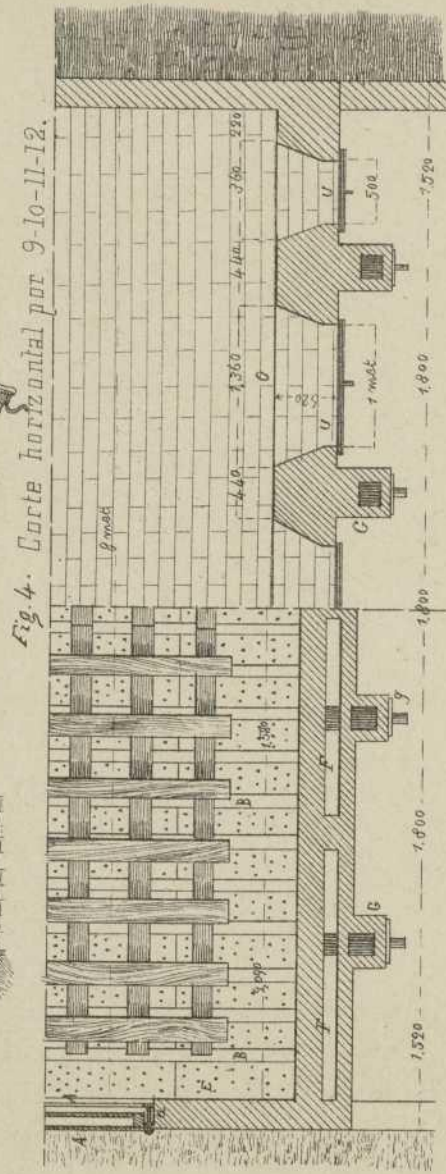
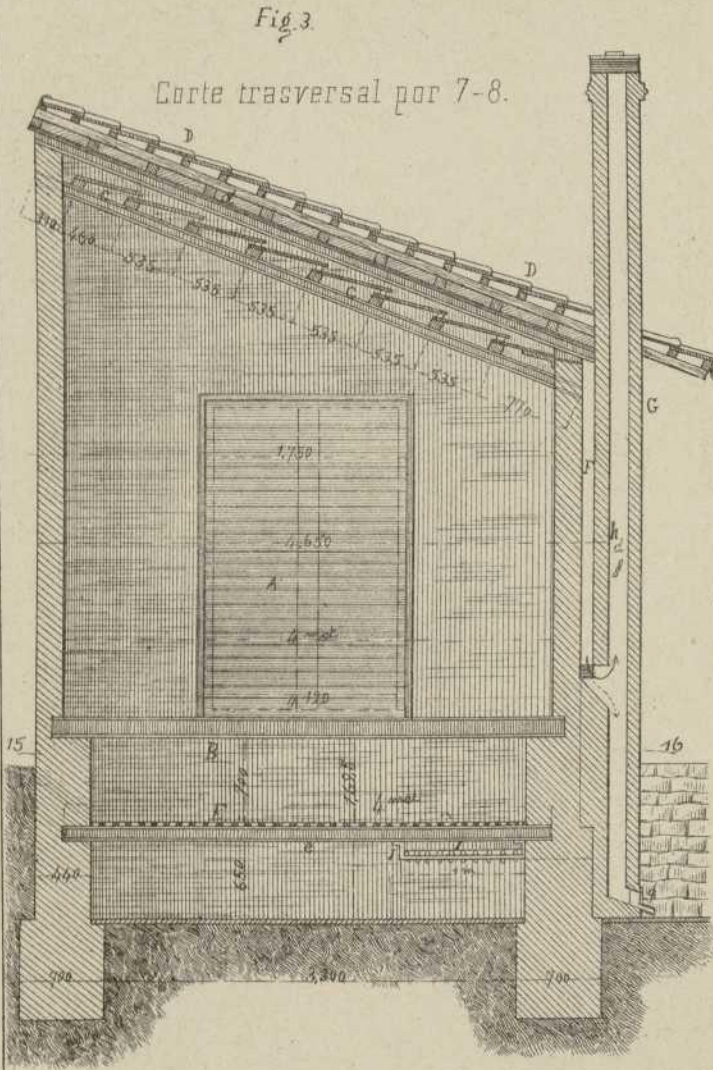
Corte longitudinal por 1-2-3-4.



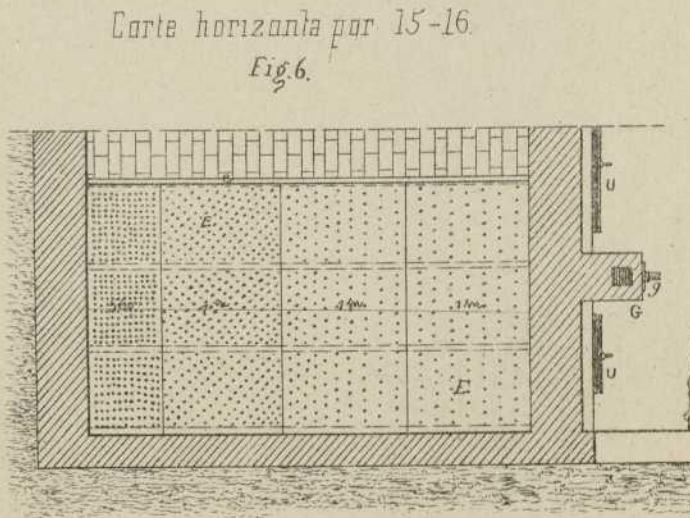
Corte trasversal por 5-6.

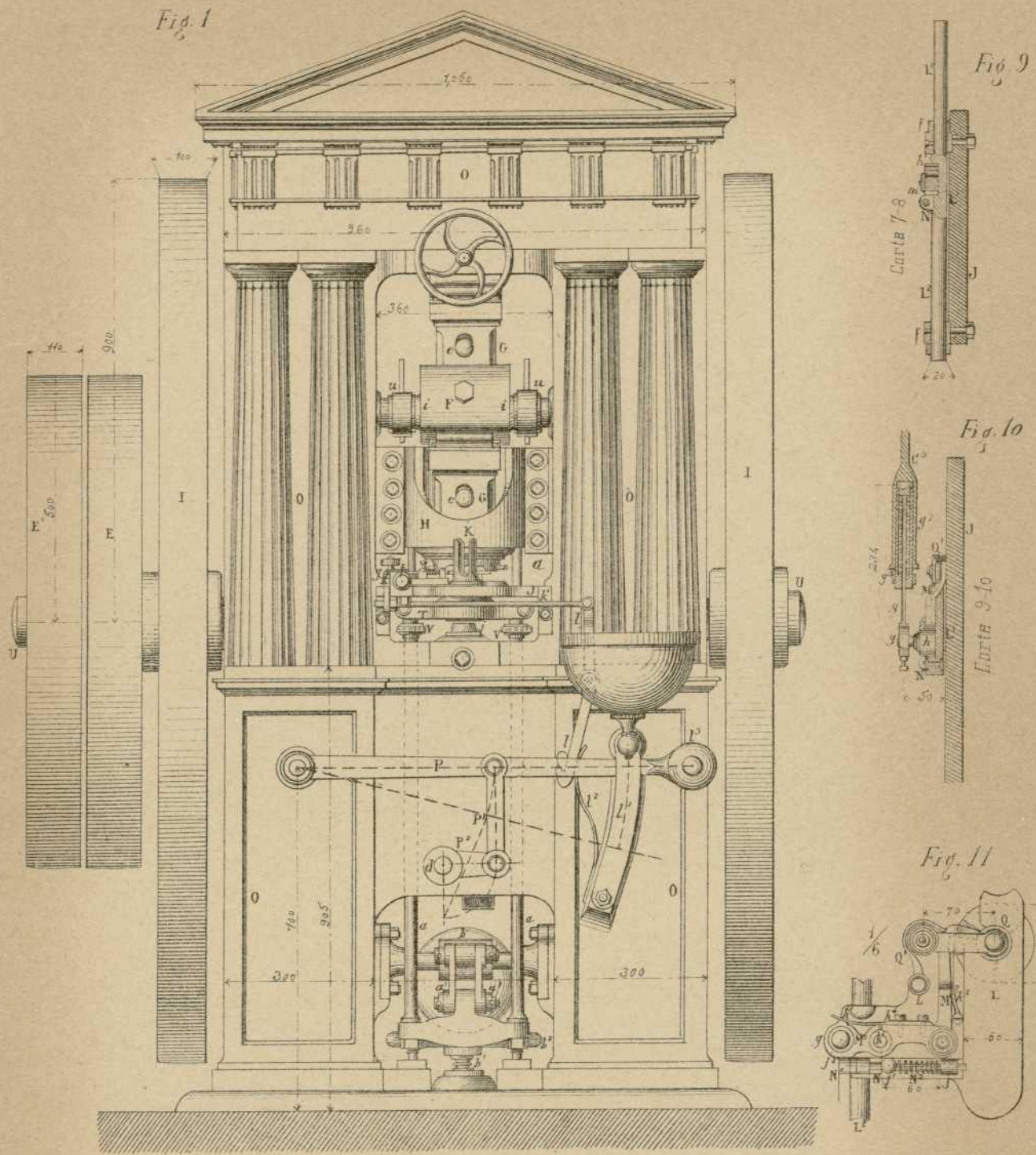
Fig. 2.



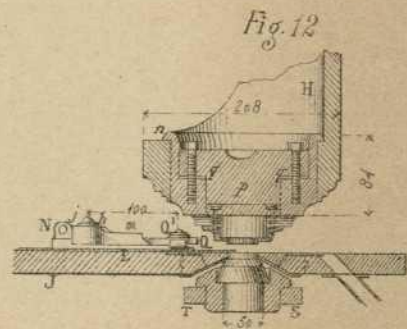
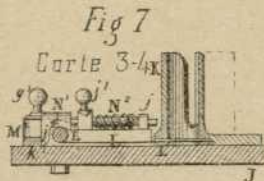
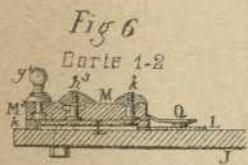


Escala de $\frac{1}{60}$.

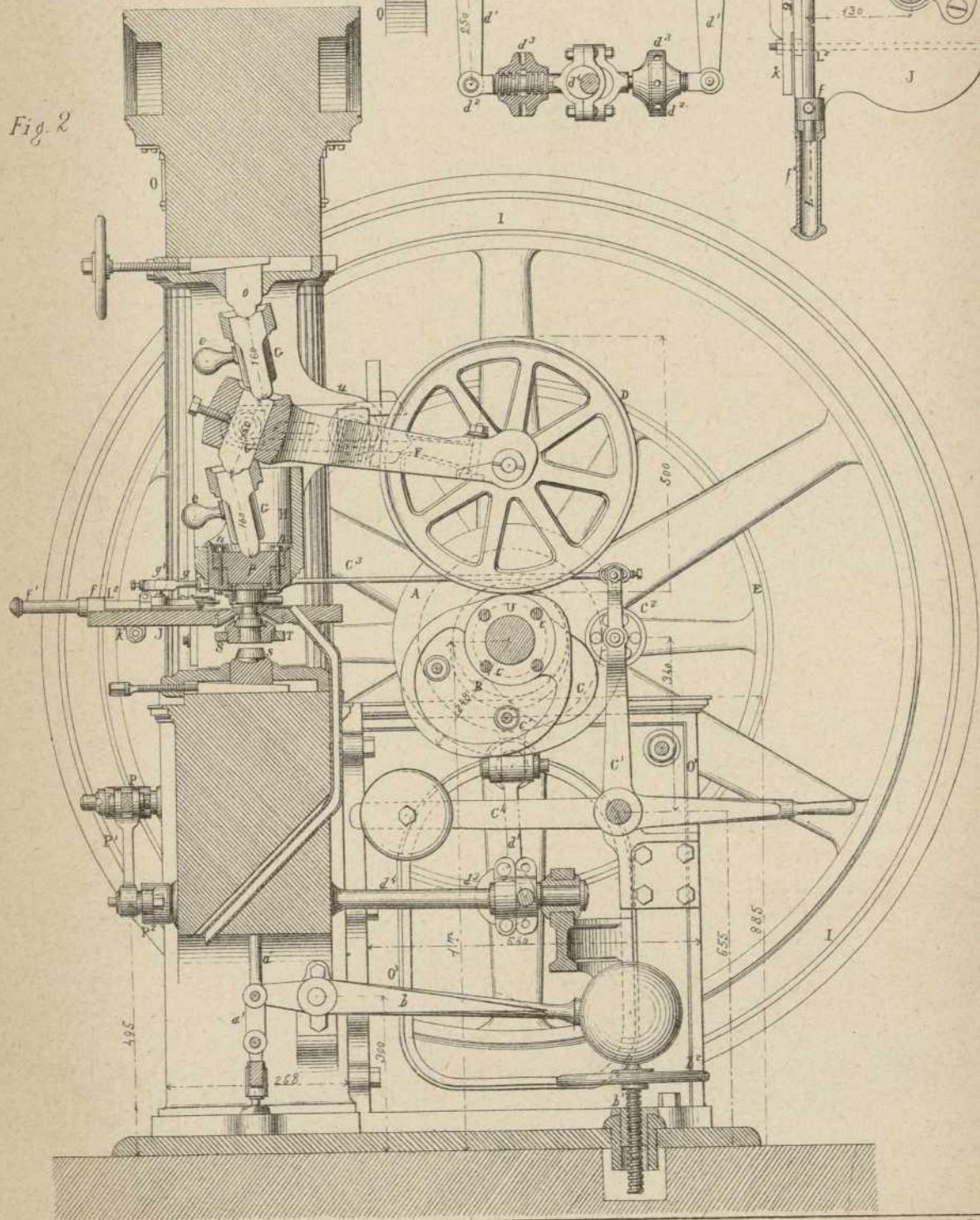
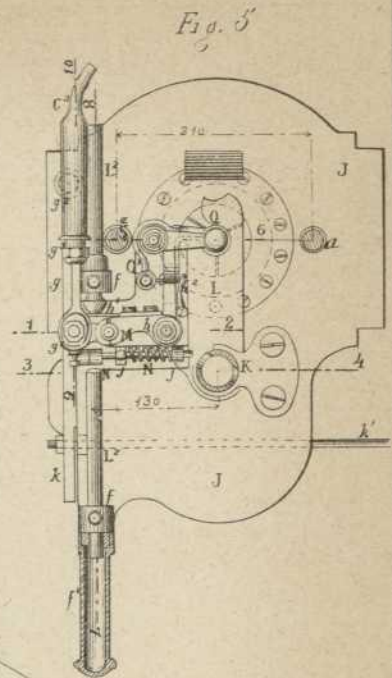
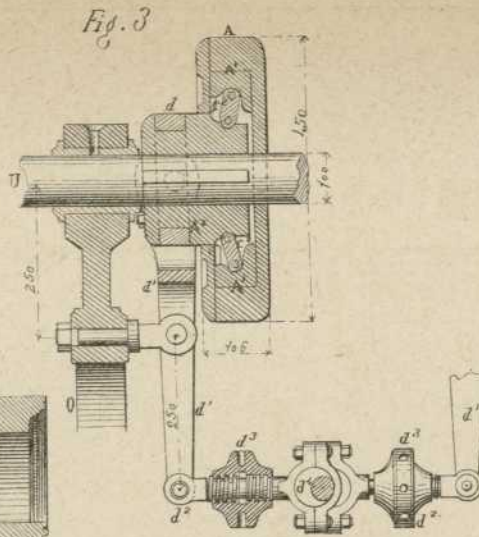
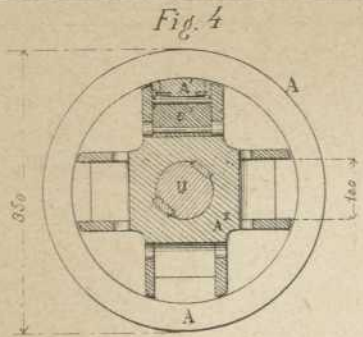


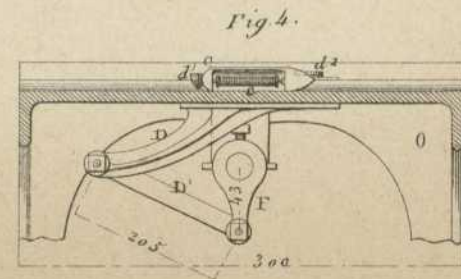
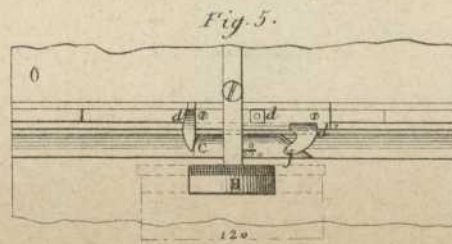
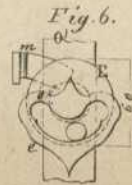
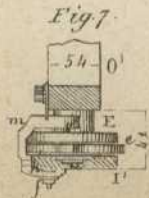
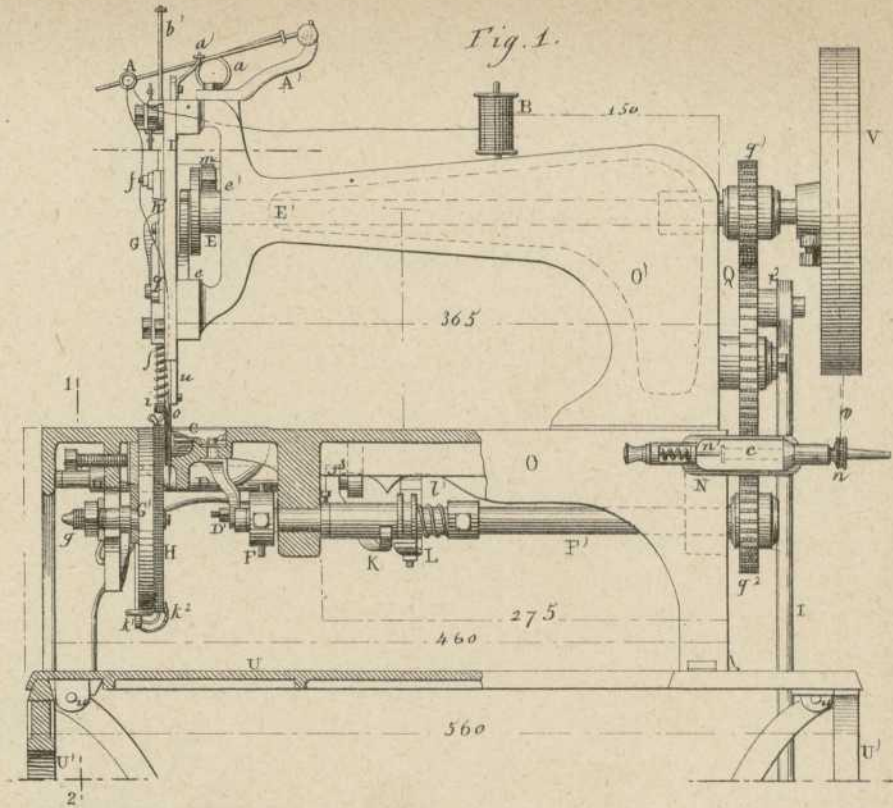
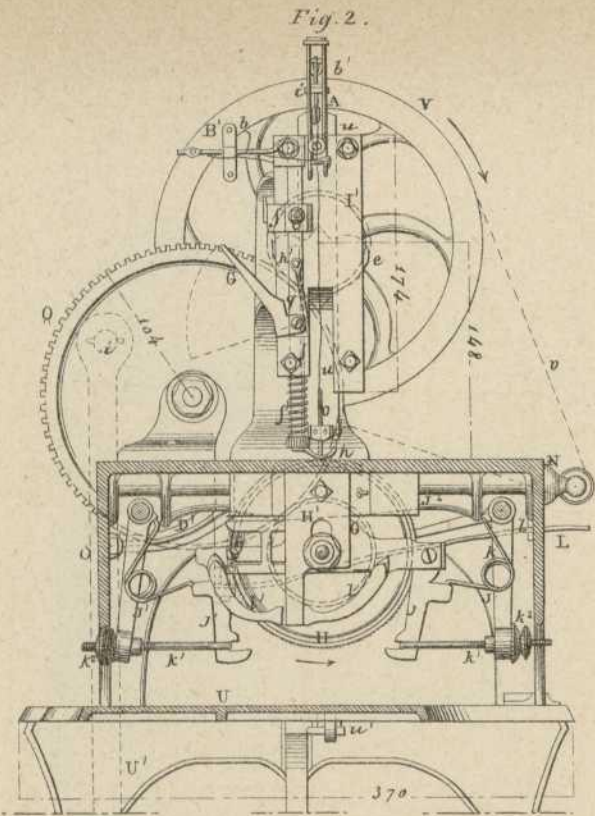


Escala de $\frac{1}{2}$ por las Fig. 1 á 4.



Escala de $\frac{1}{8}$ por las Fig. 5 á 10 y 12.





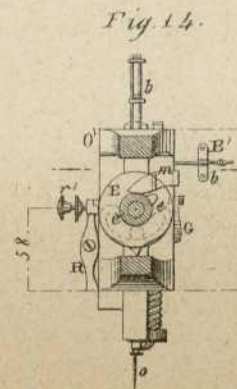
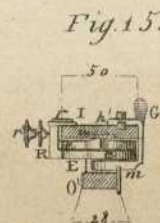
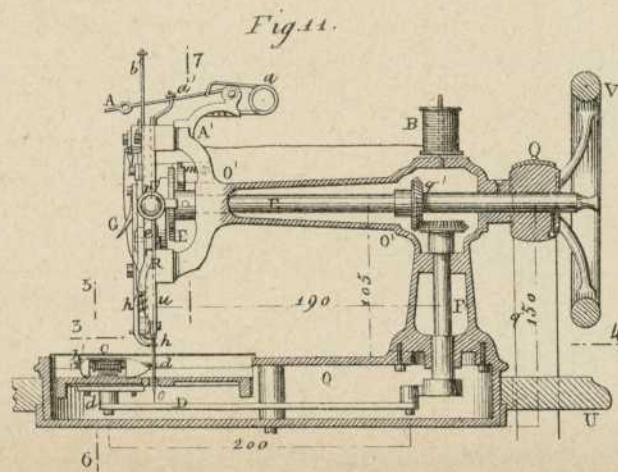
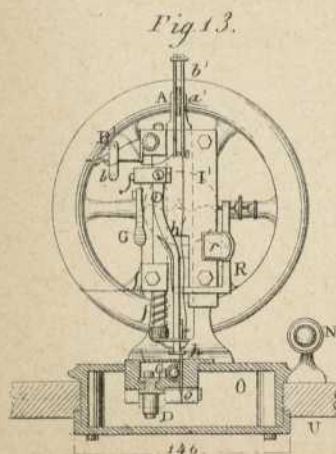
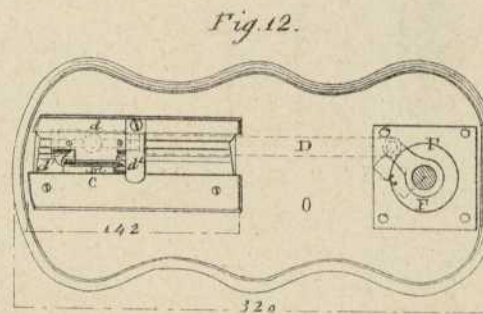
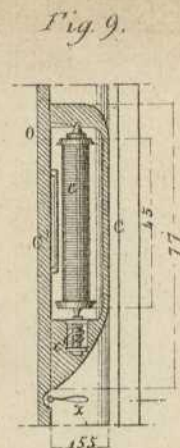
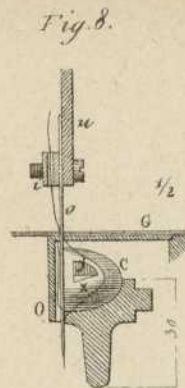
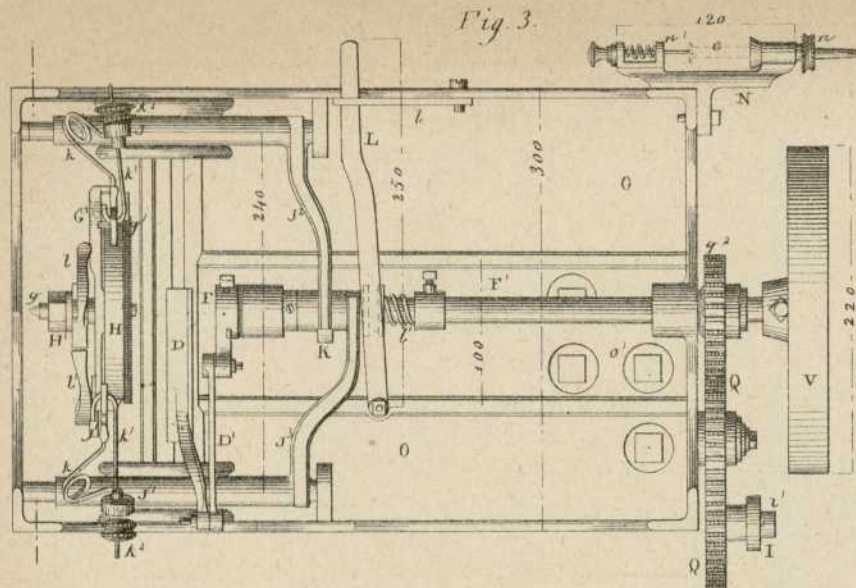
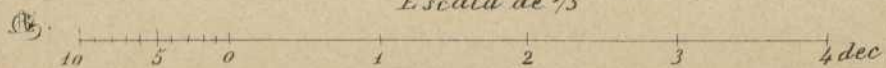
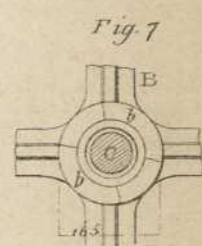
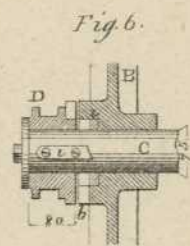
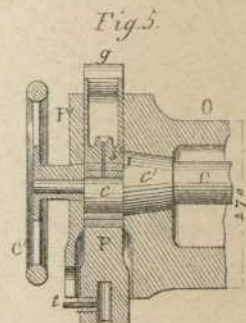
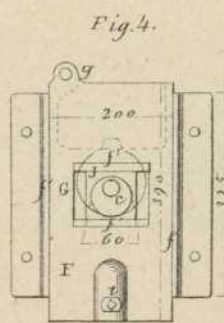
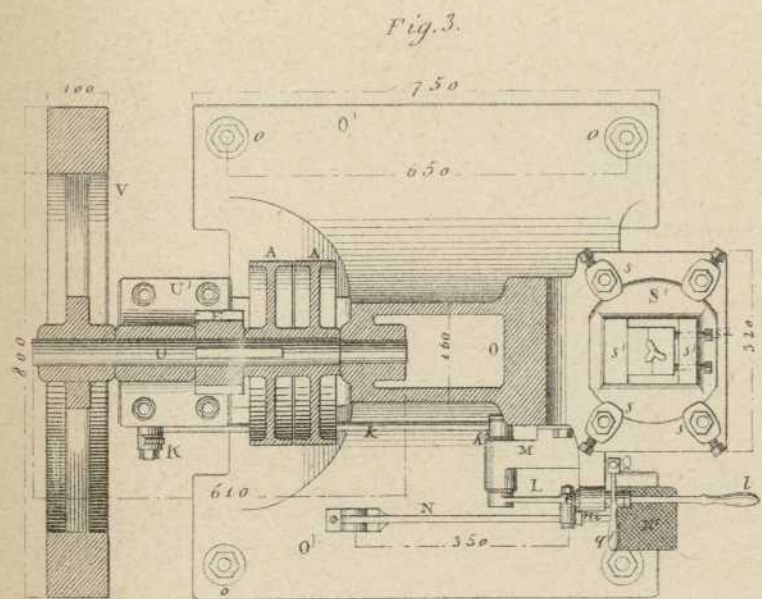
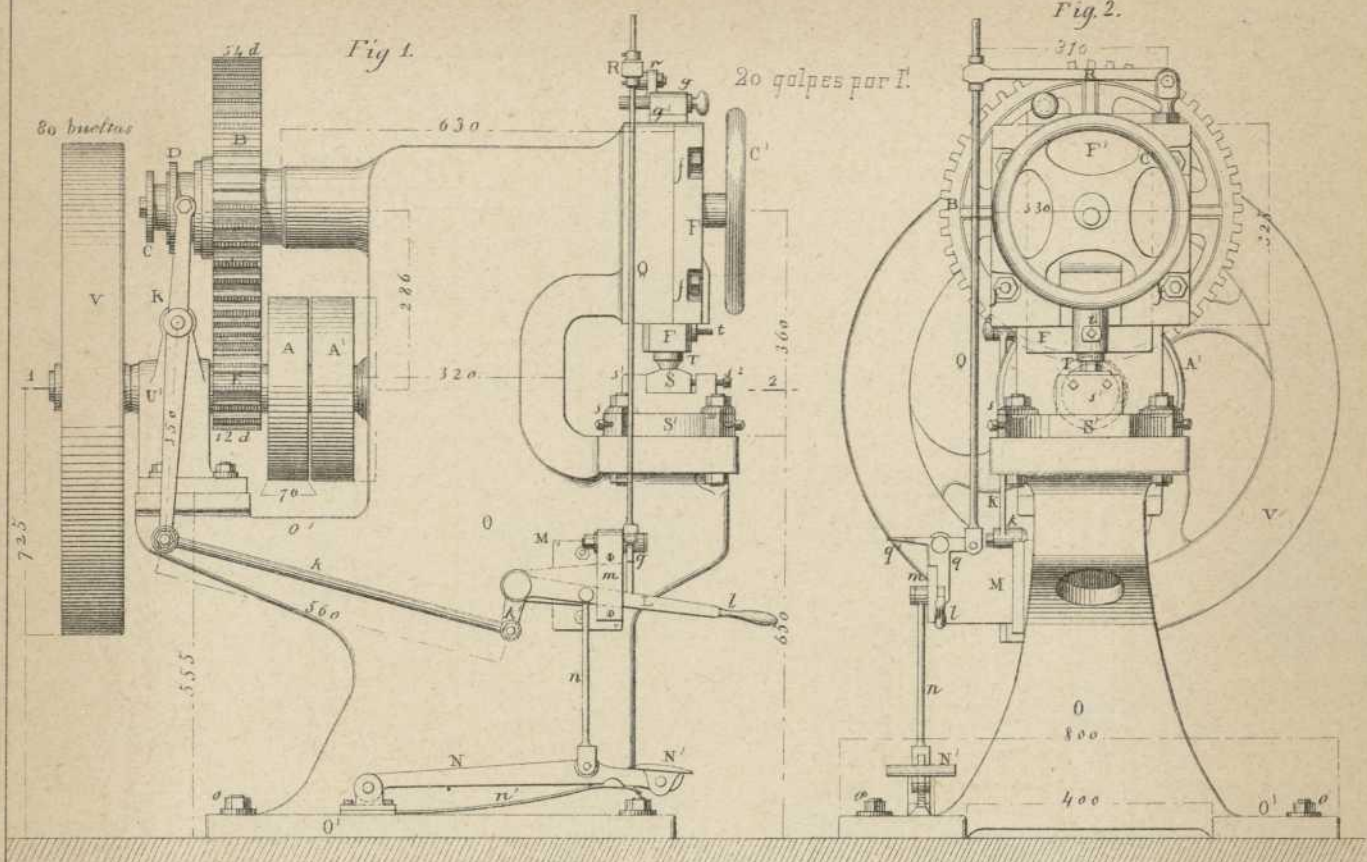
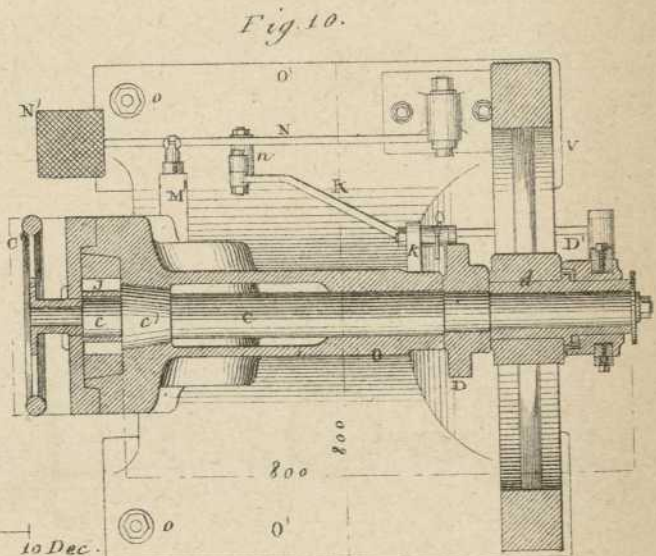
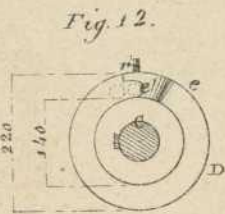
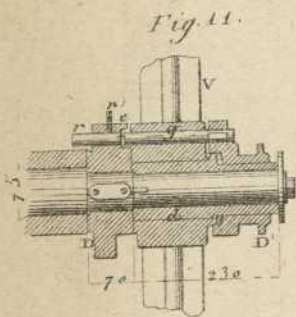
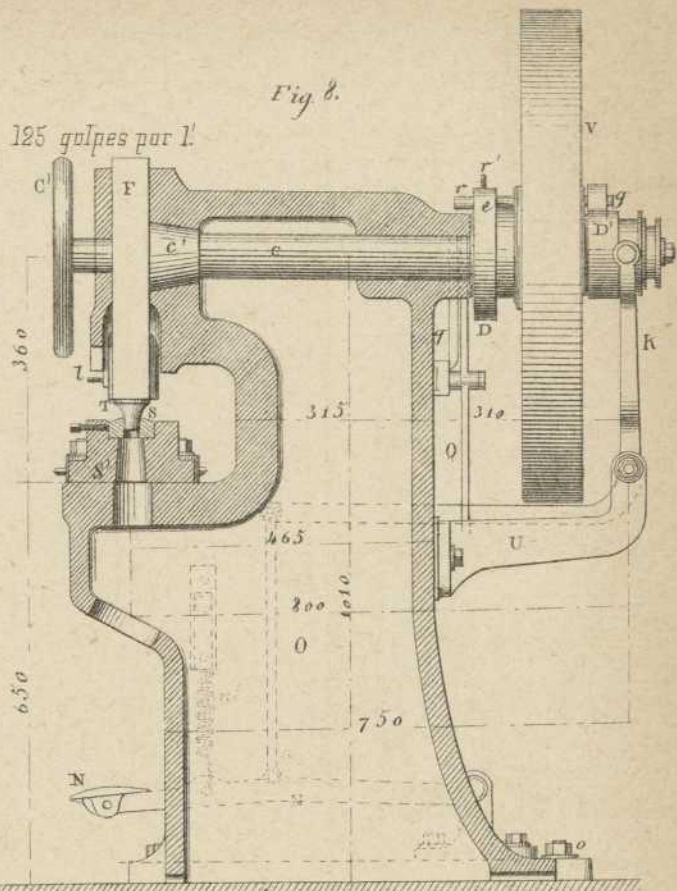
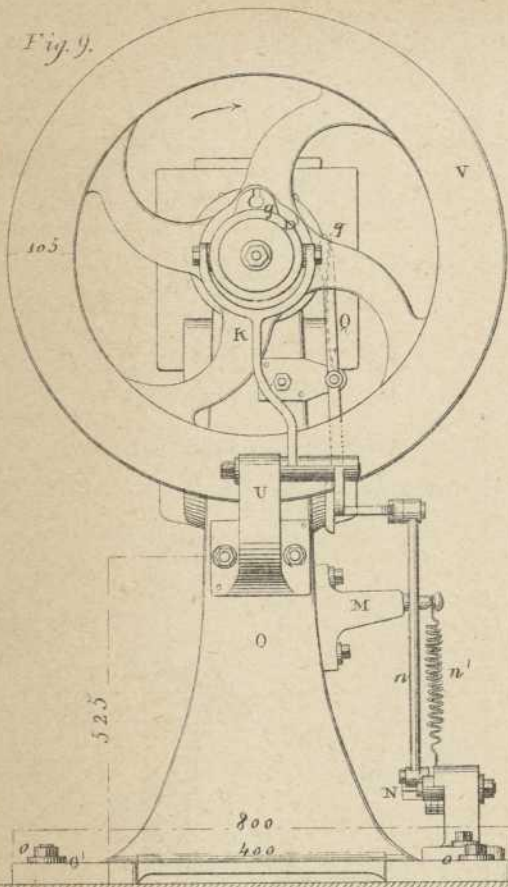


Fig. 10.

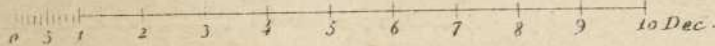
Hilo de la aguja.
Hilo de la lanzadera.

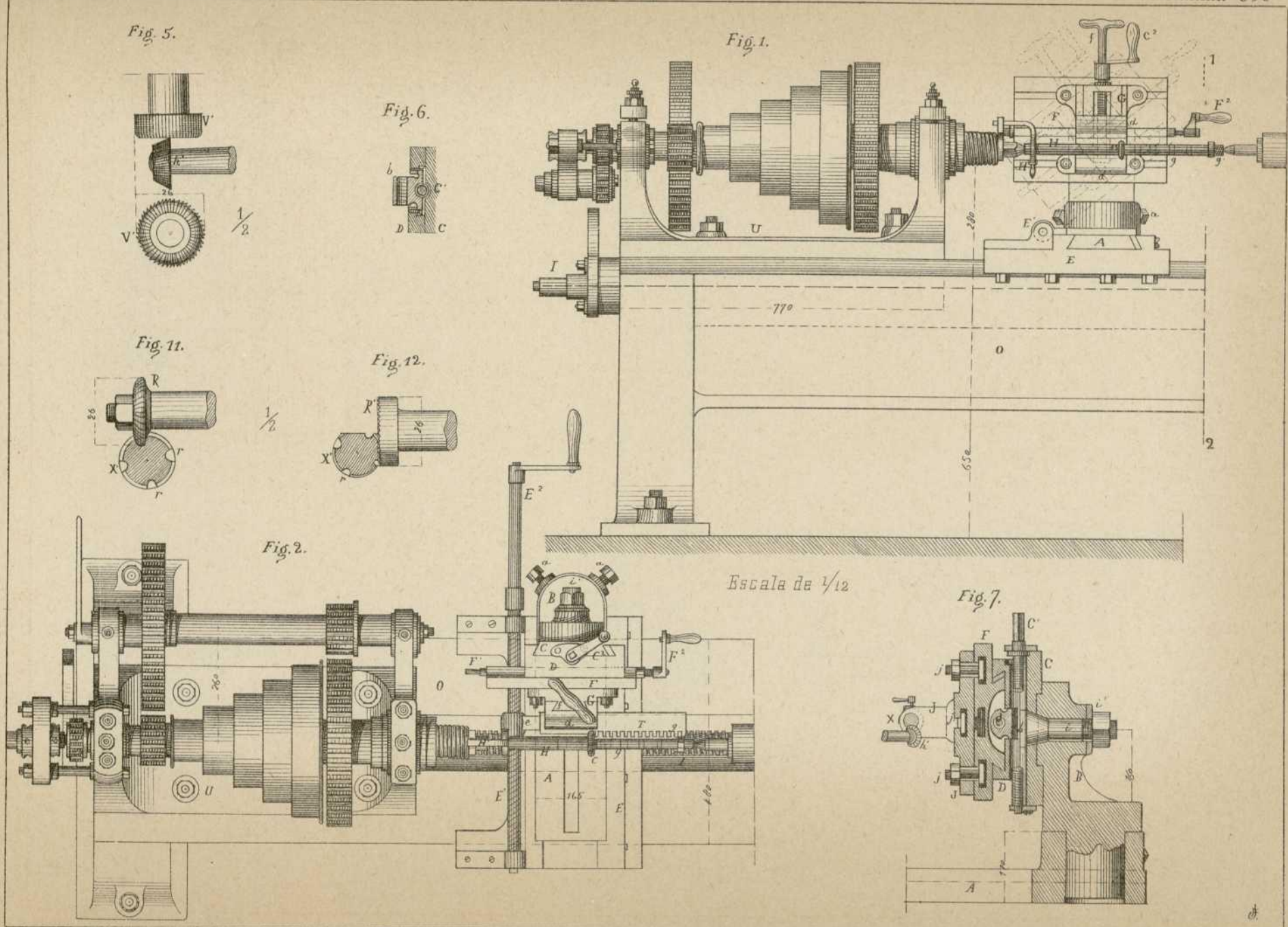






Escala de 1/12





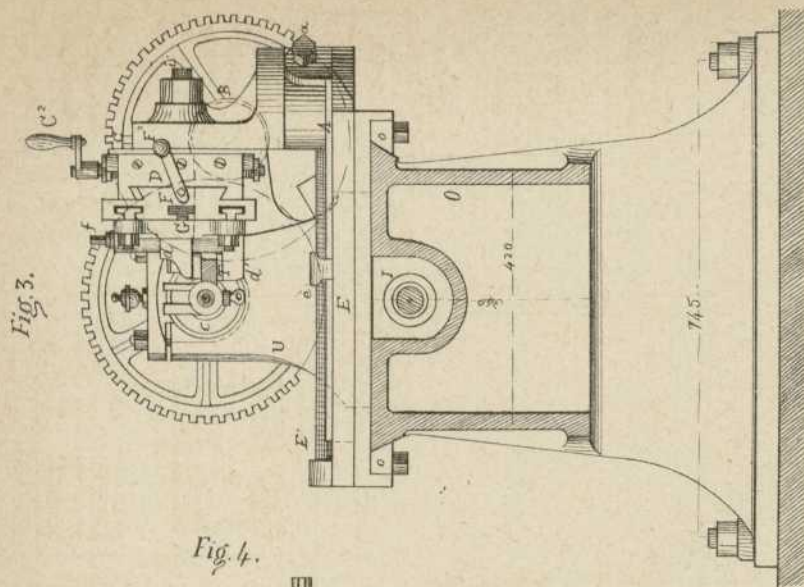


Fig. 3.

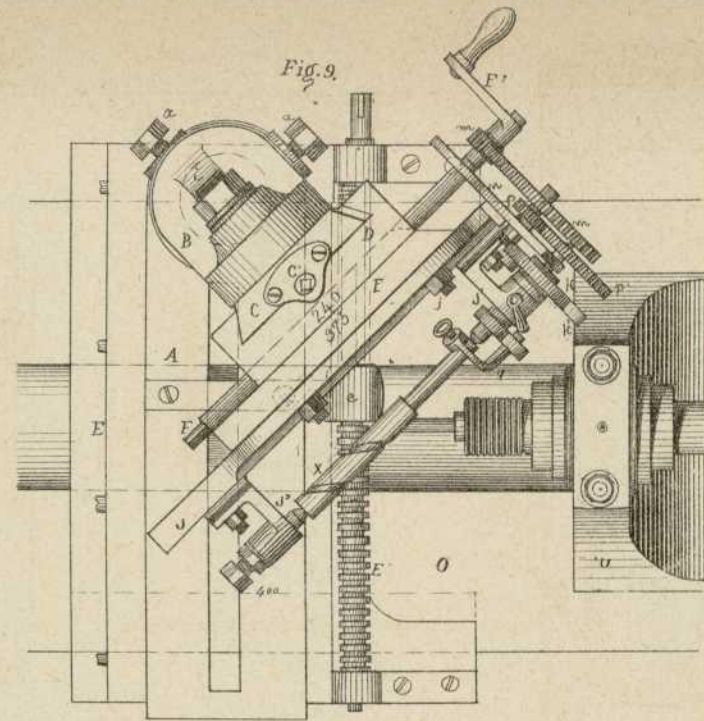


Fig. 9.

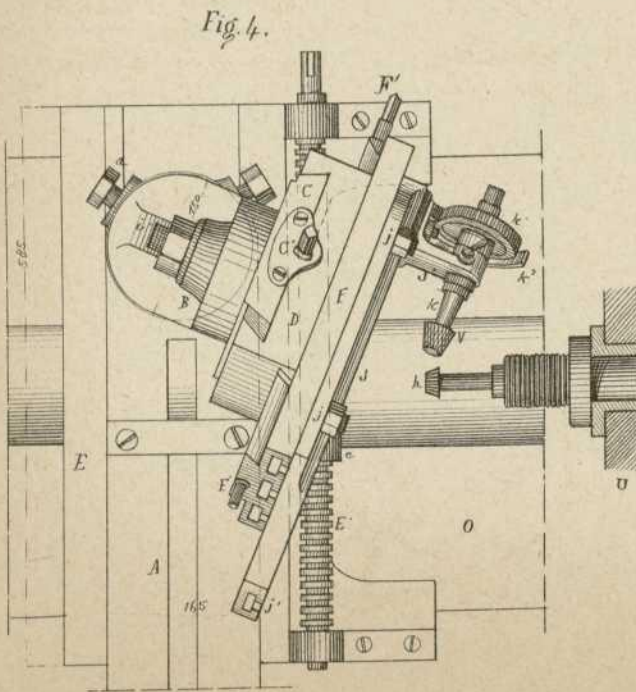


Fig. 4.

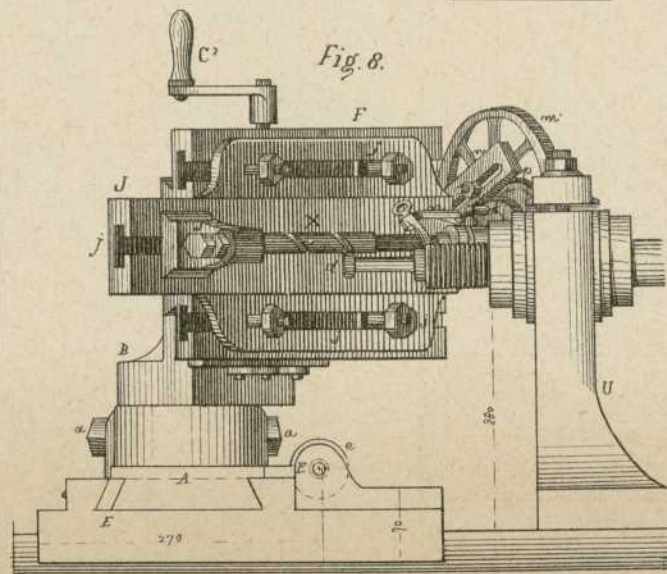


Fig. 8.

Escala de 1/8.

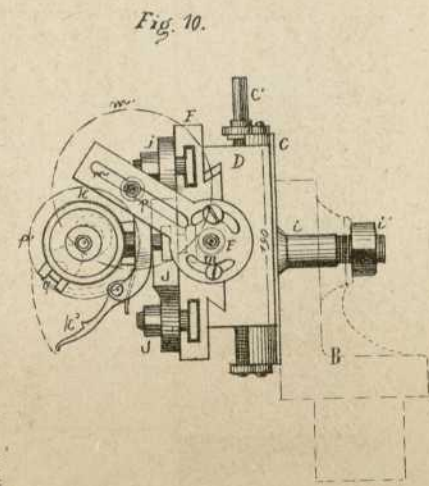
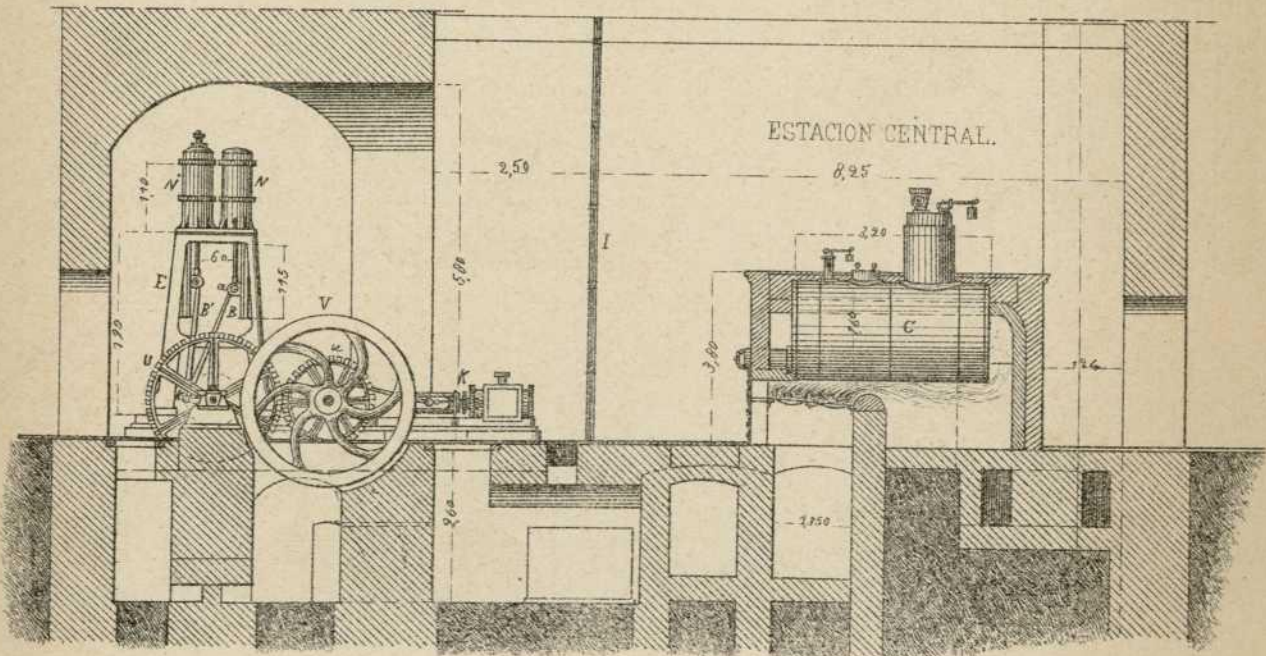
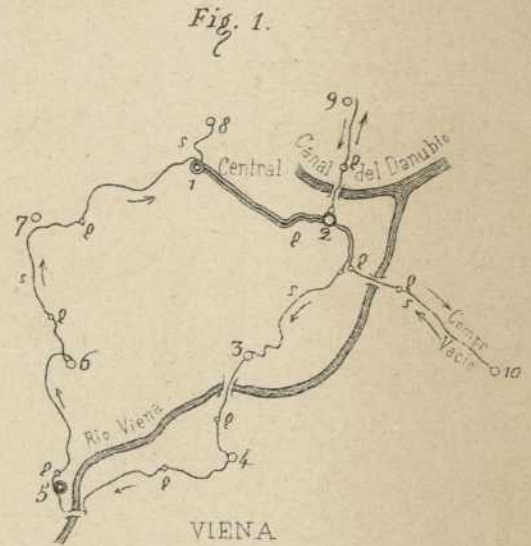
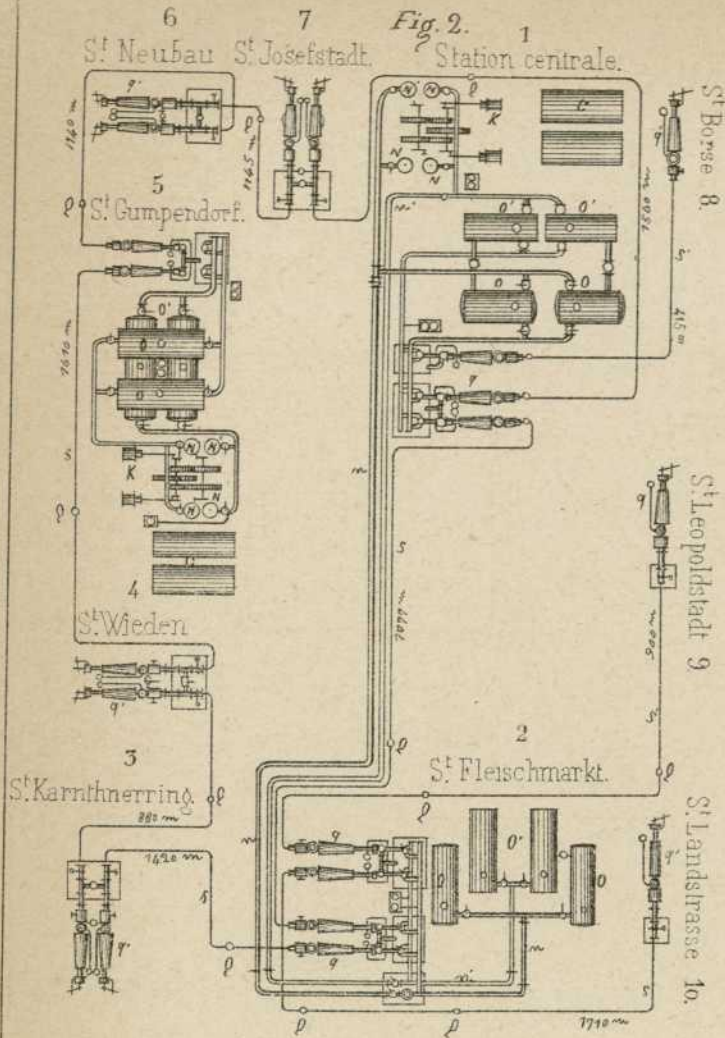


Fig. 10.



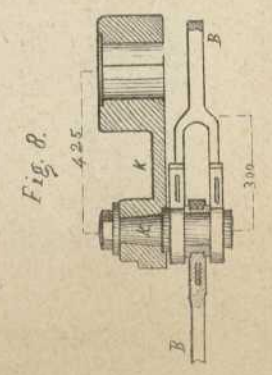
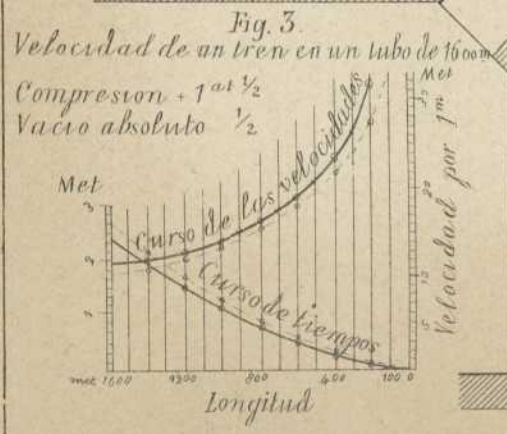
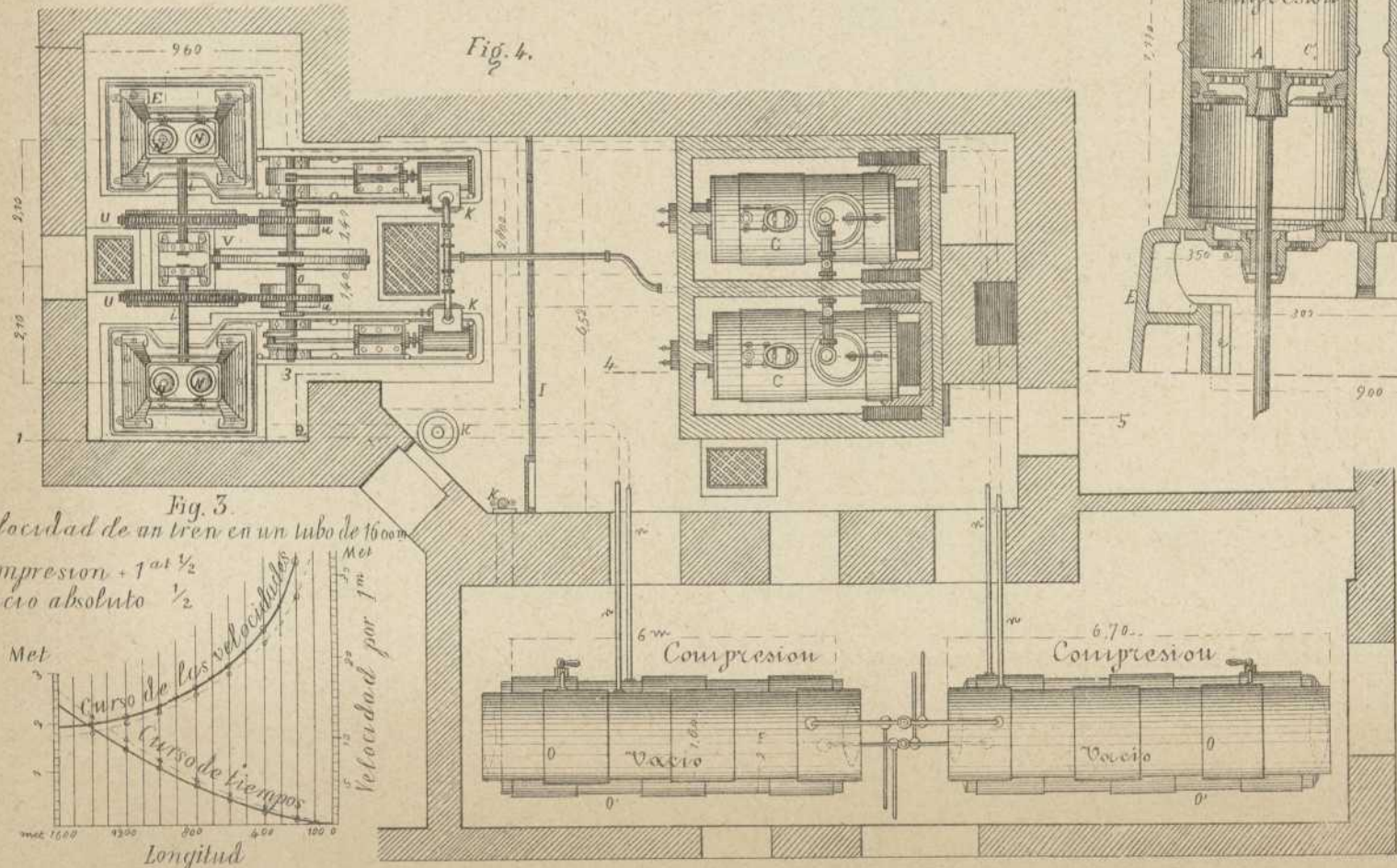
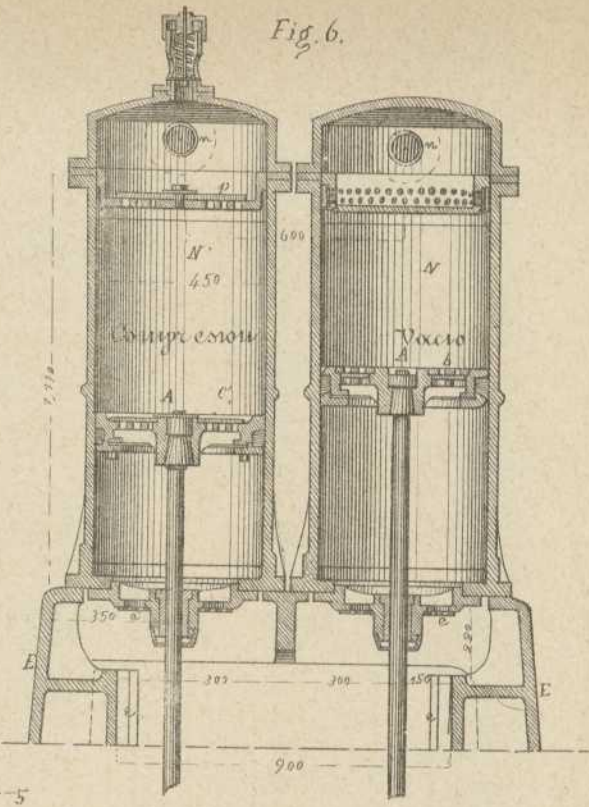
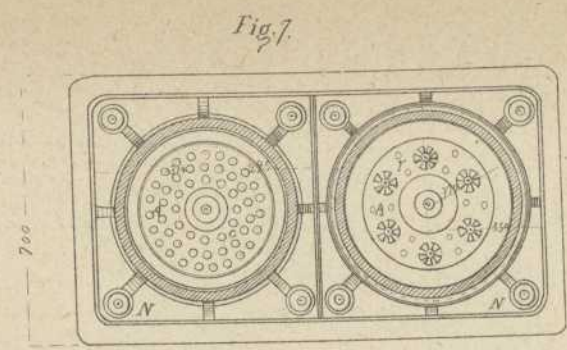
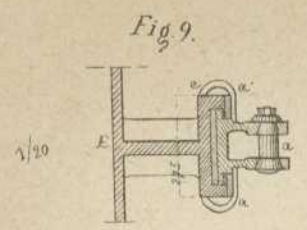


Fig. 1.

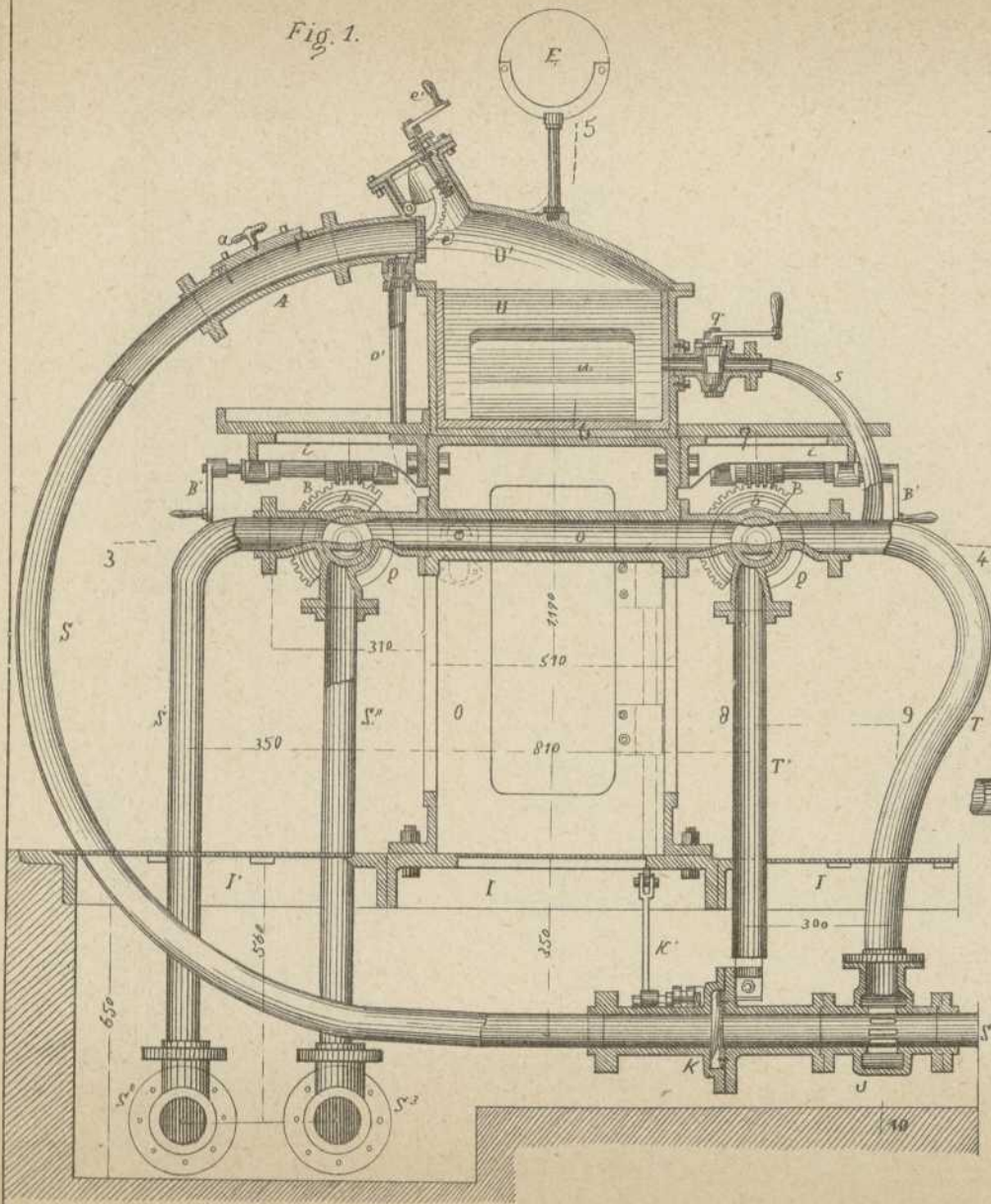


Fig. 5.

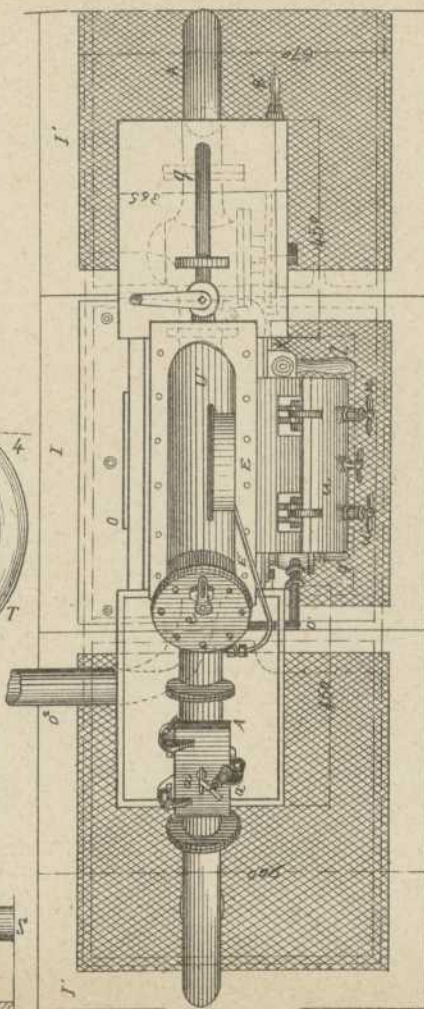
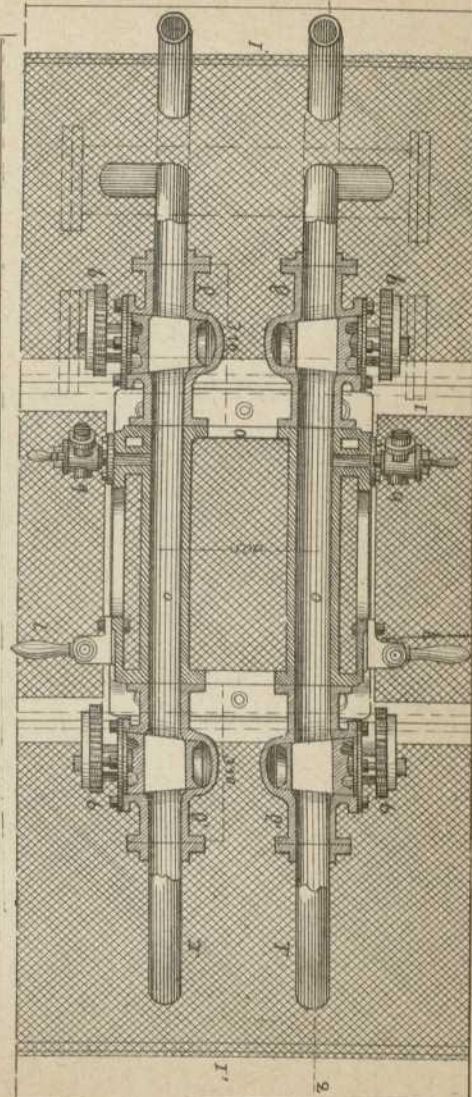
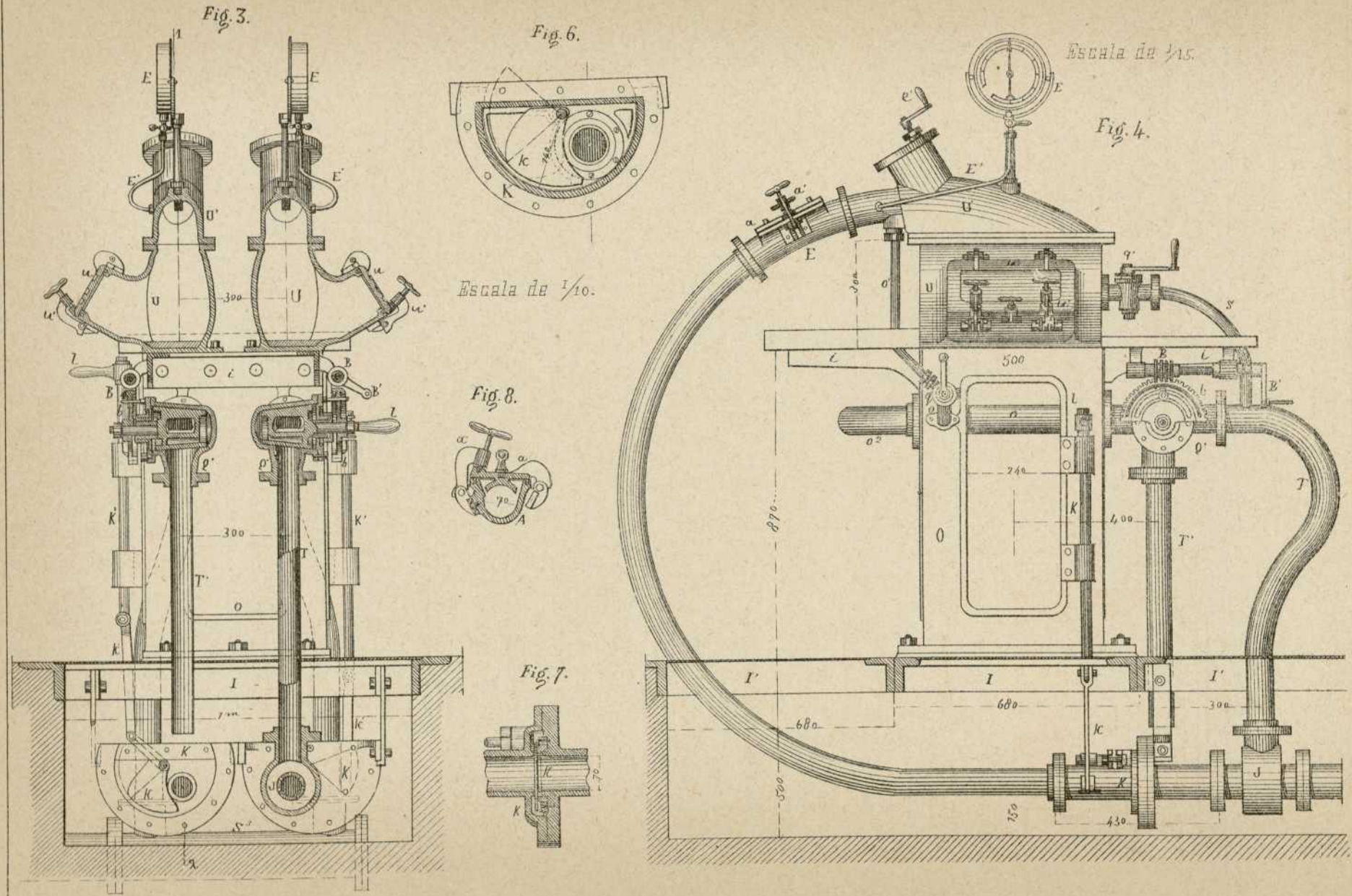


Fig. 2.





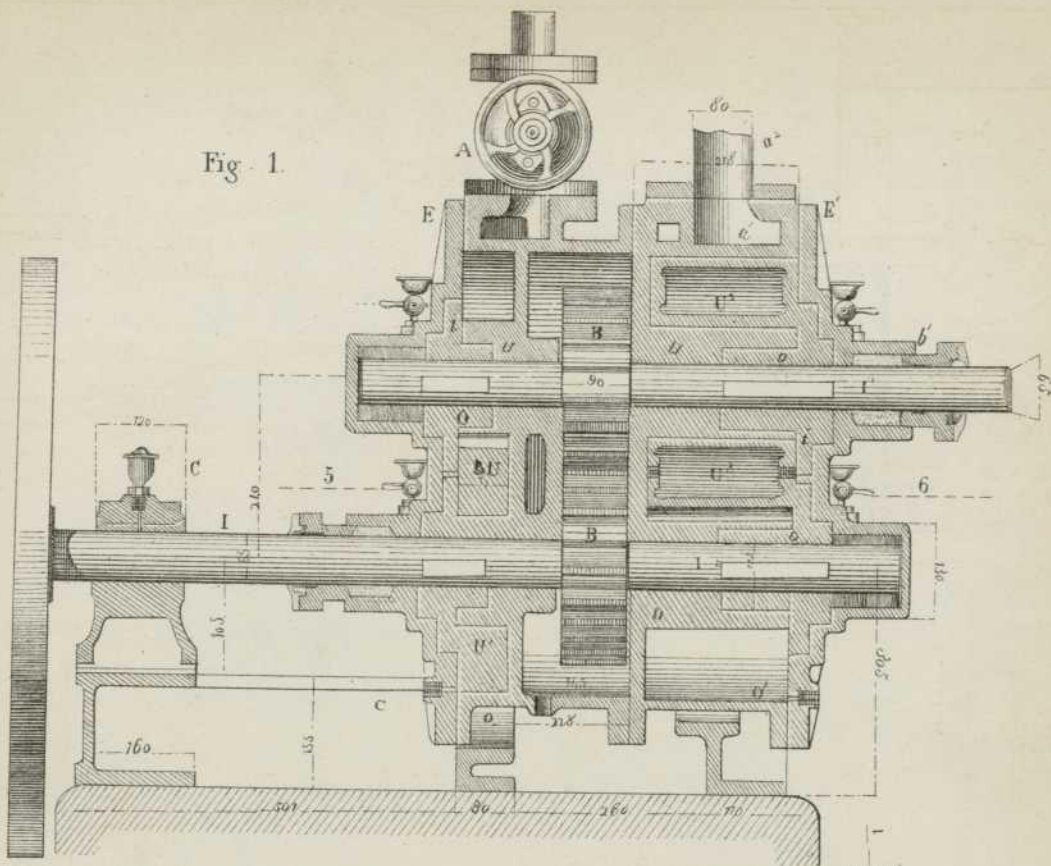
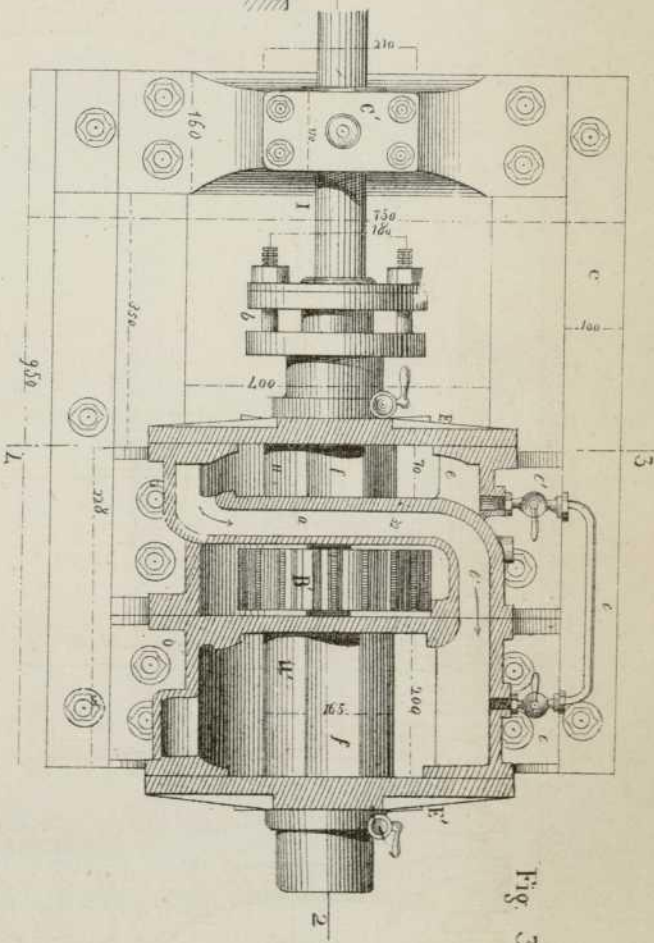
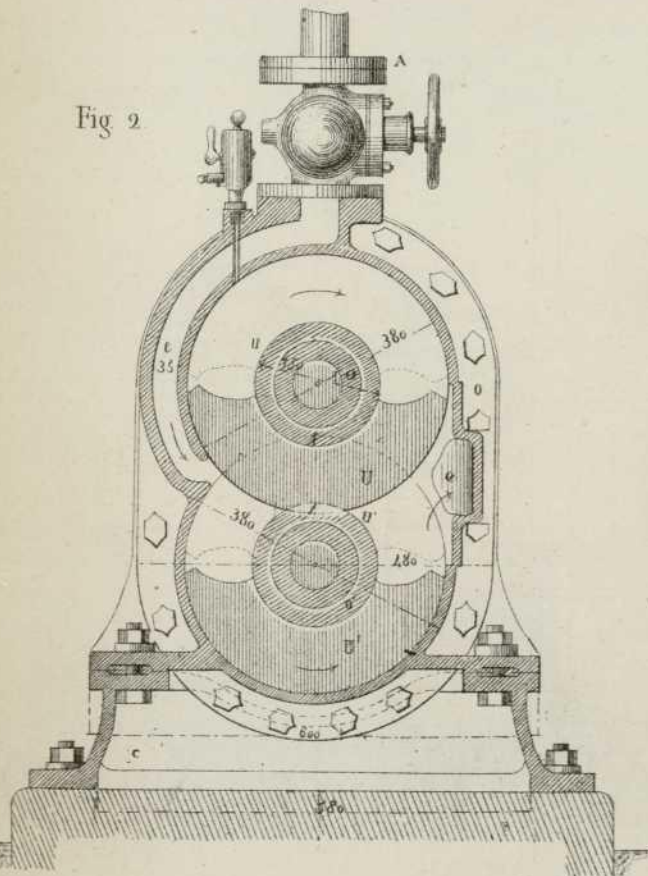


Fig 2



Escala de 1/10 por las Fig 1 a 3.

A.R.

Nacenta, editor.

Paseo de Gracia, 149.

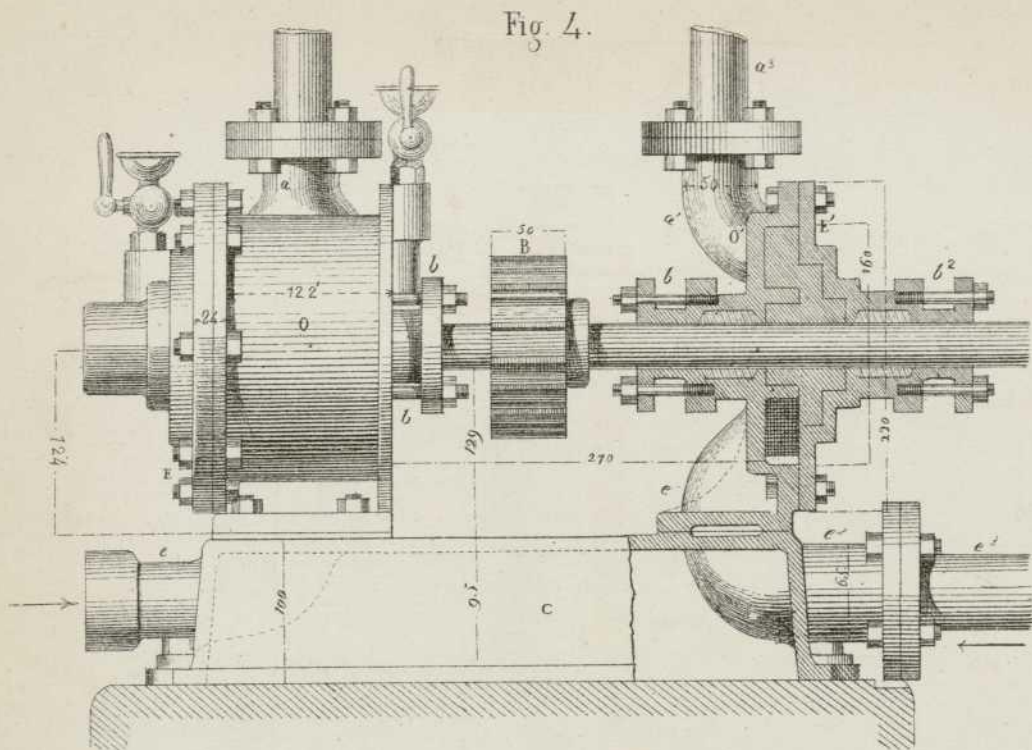


Fig. 4.

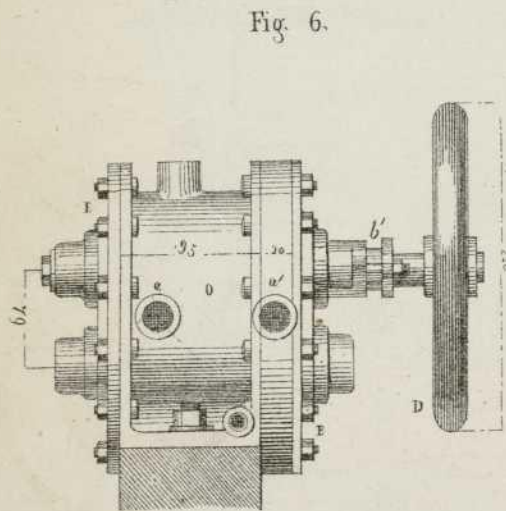


Fig. 6.

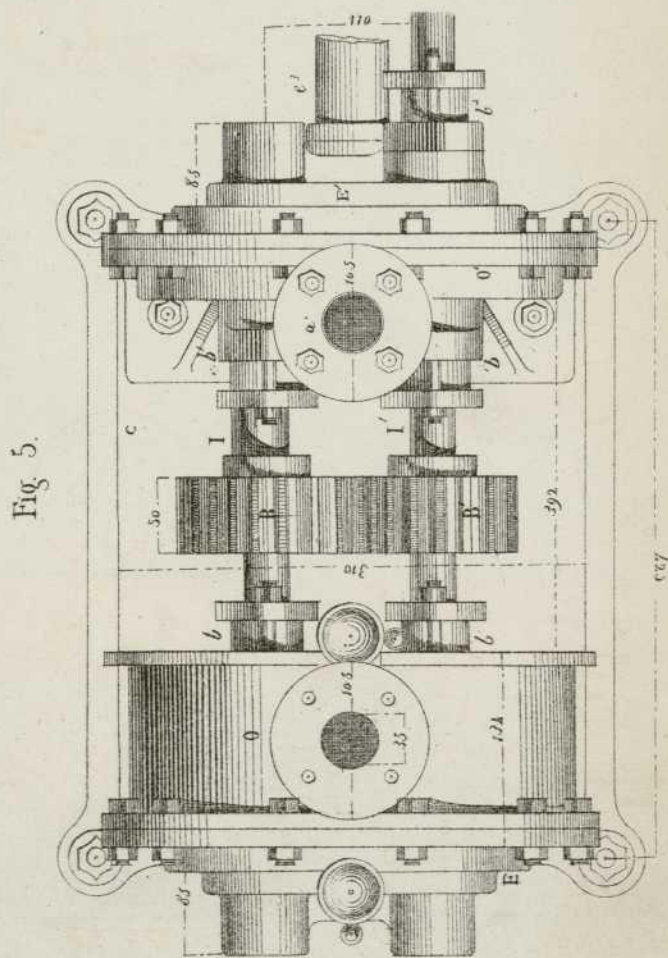
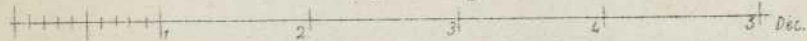
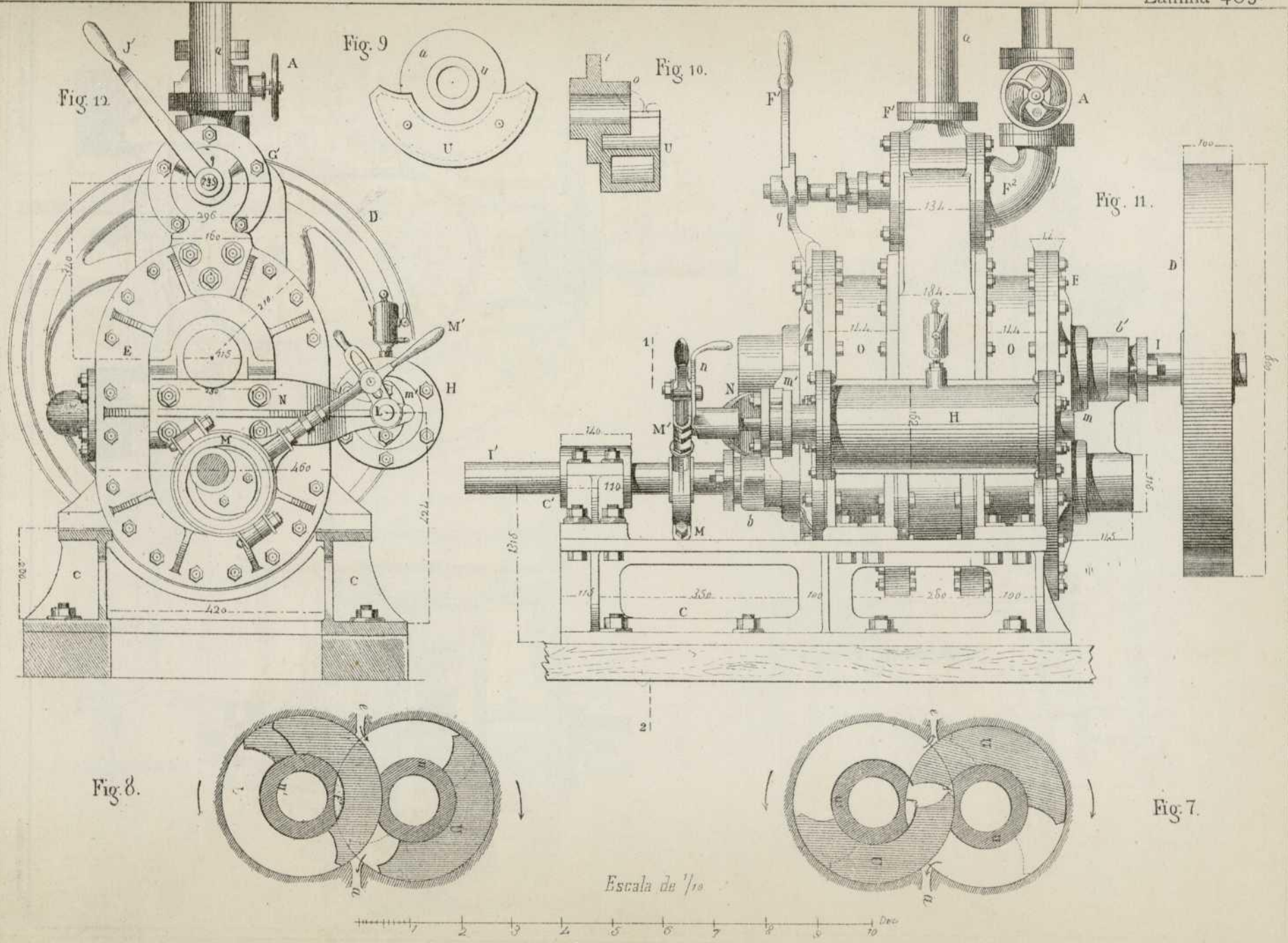


Fig. 5.

Escala de $\frac{1}{5}$ por las Fig. 4. a 6.





Escala de 1/10

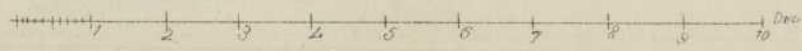


Fig. 13.

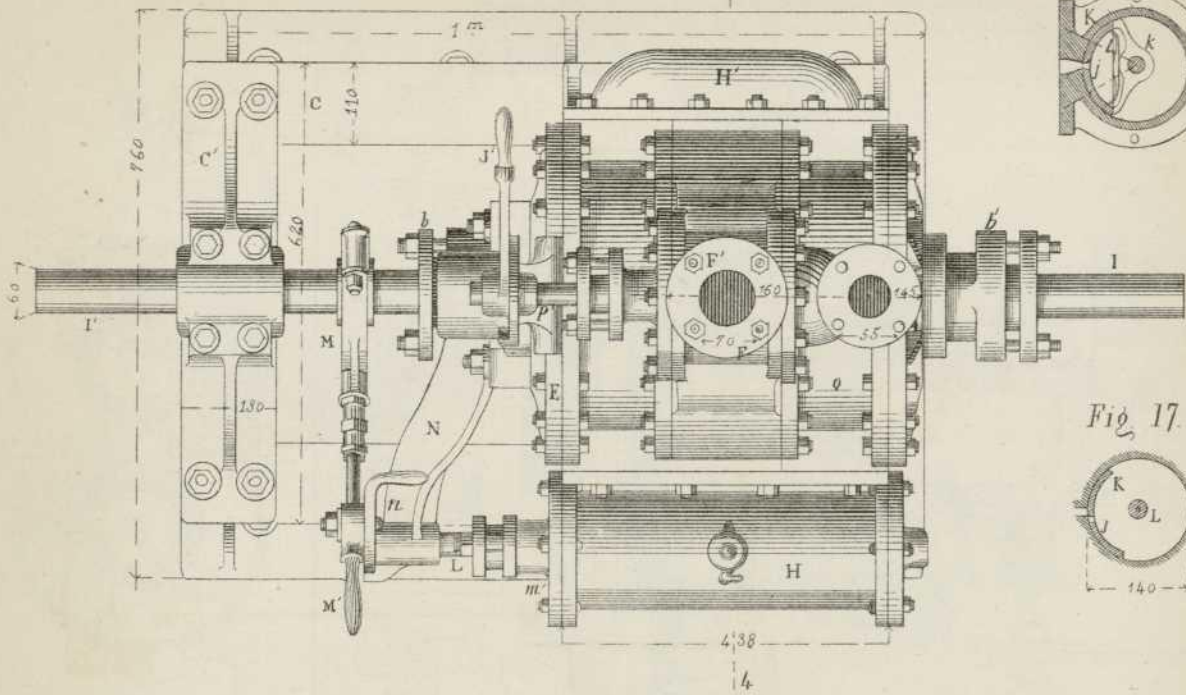


Fig. 16.

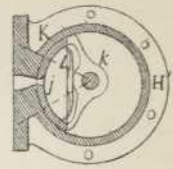


Fig. 17.

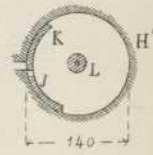


Fig. 15.

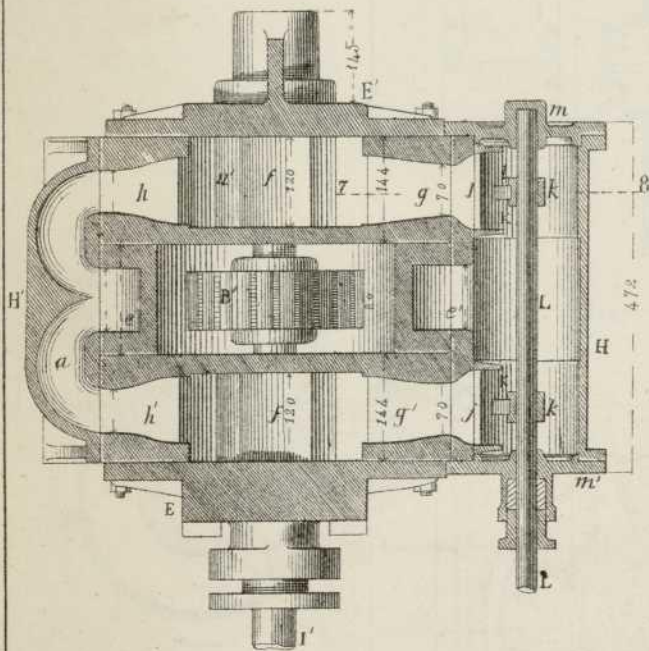
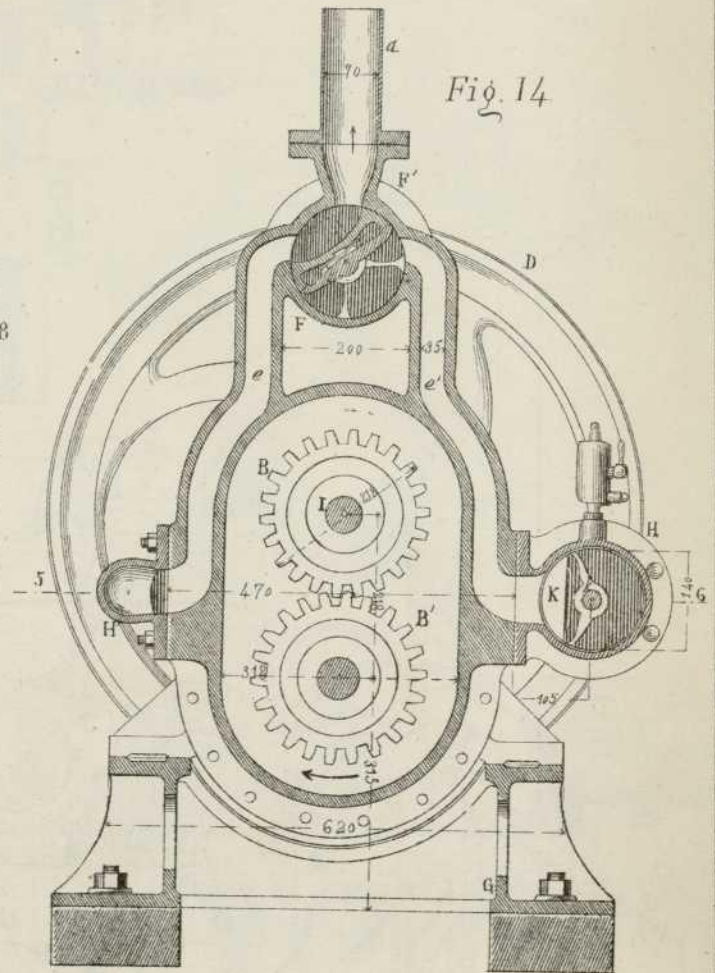
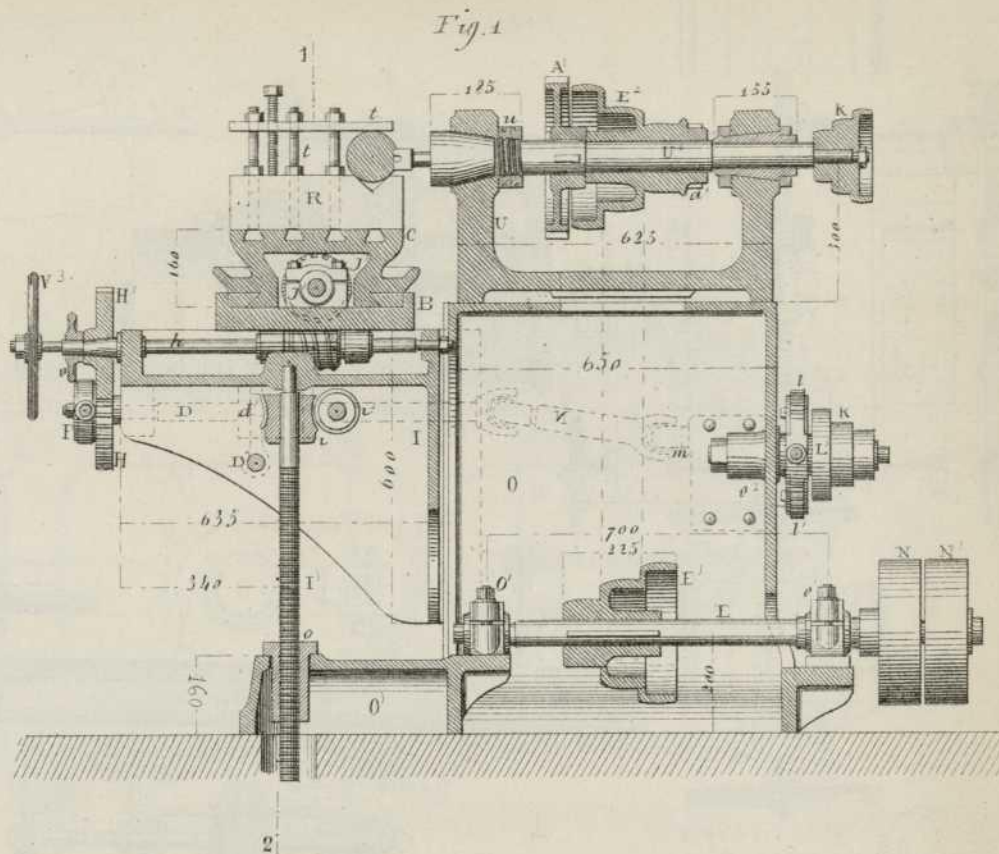
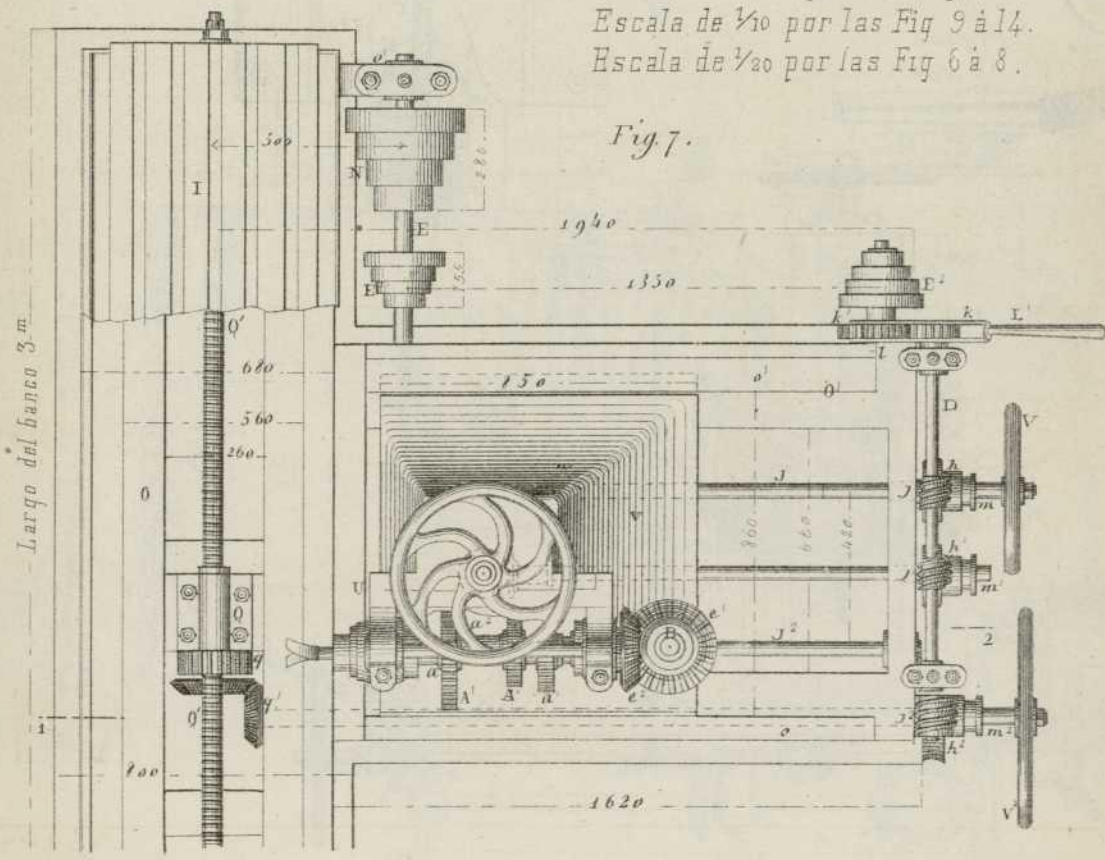


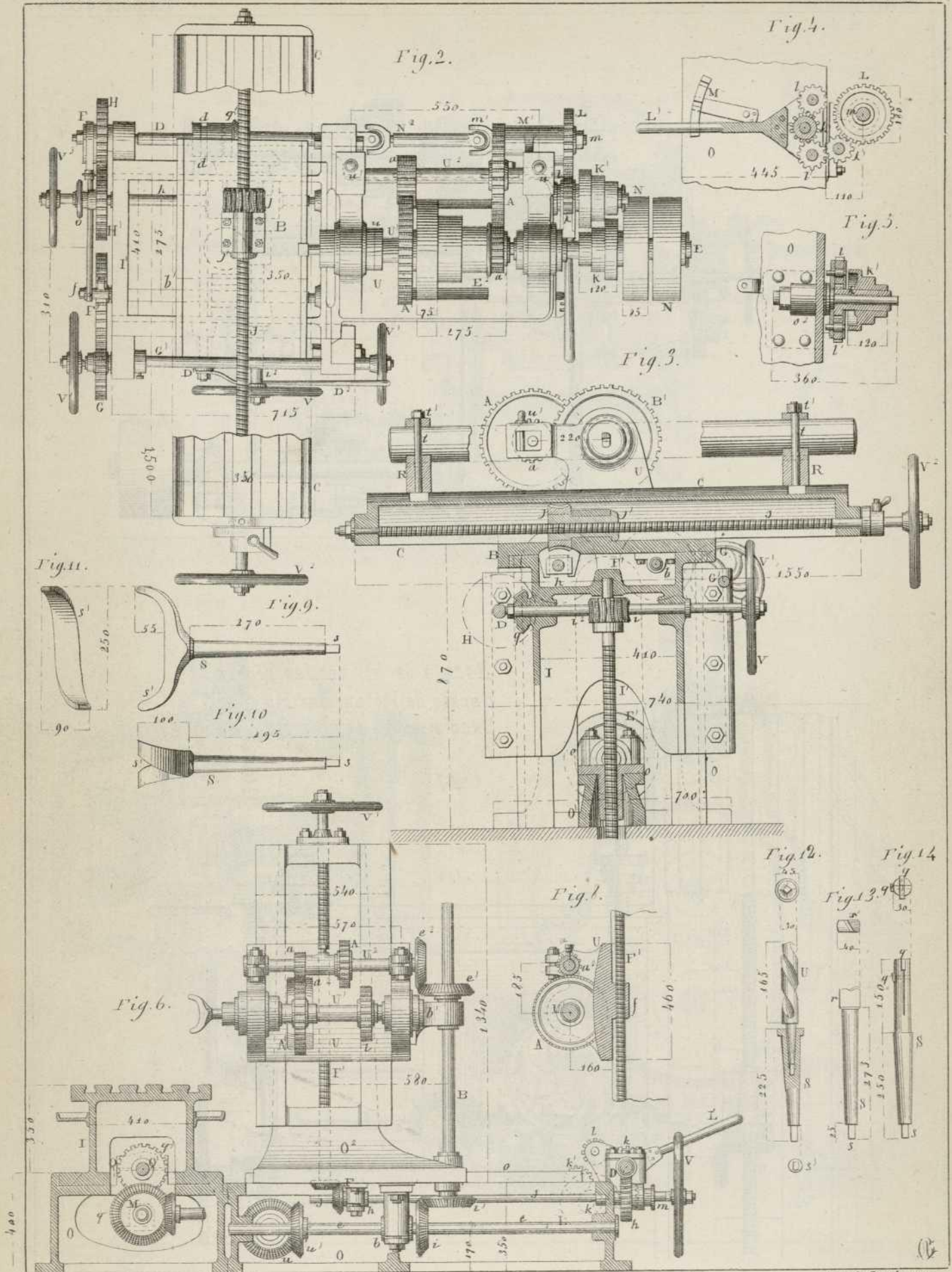
Fig. 14.





Escala de $\frac{1}{15}$ por las Fig 1 à 5.
 Escala de $\frac{1}{10}$ por las Fig 9 à 14.
 Escala de $\frac{1}{20}$ por las Fig 6 à 8.





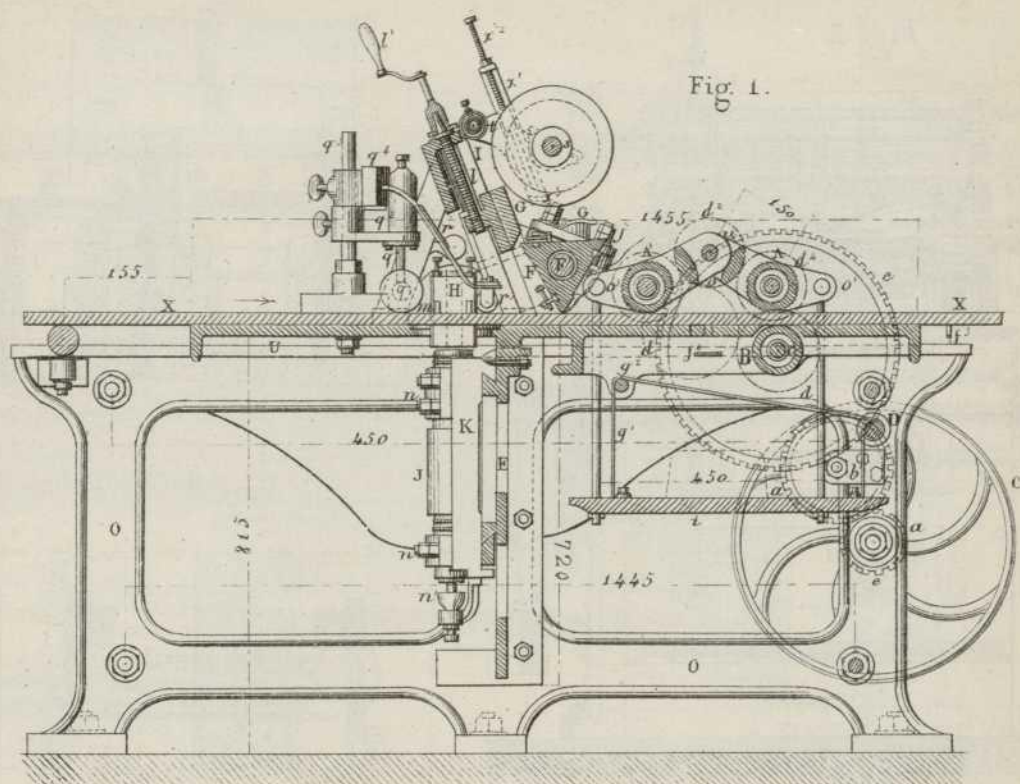
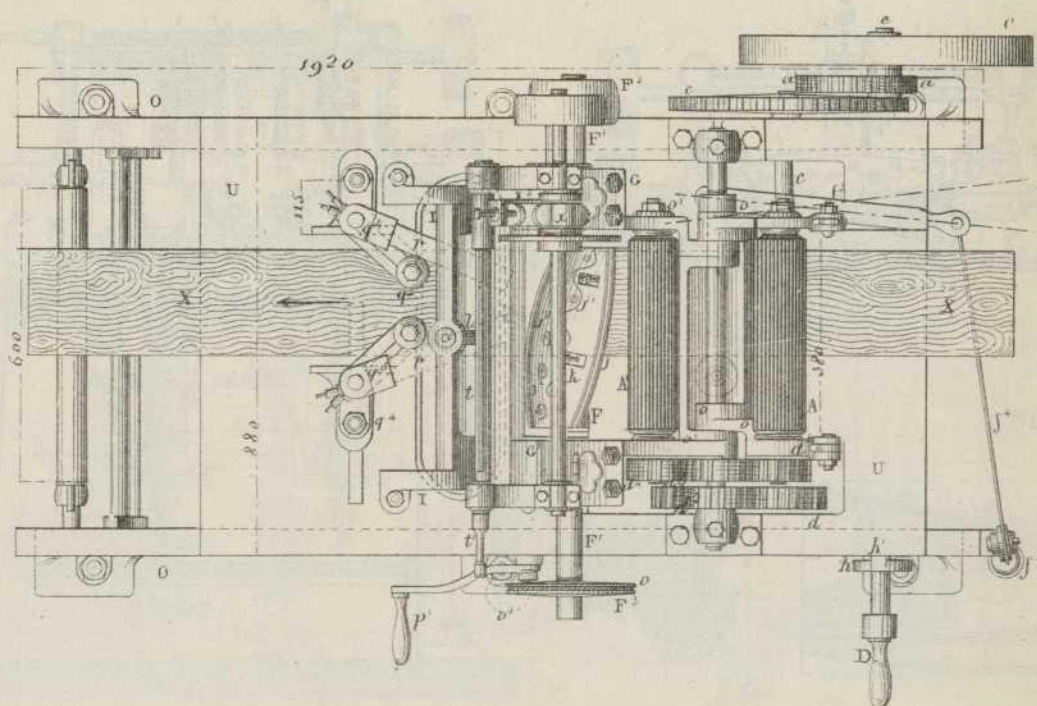


Fig. 2.



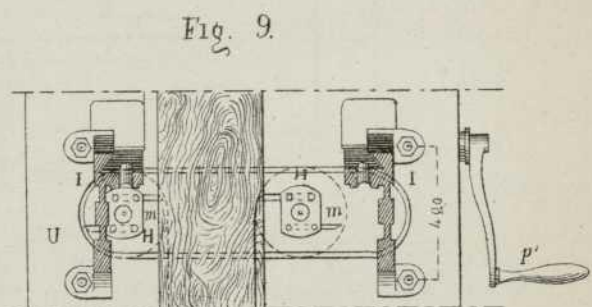
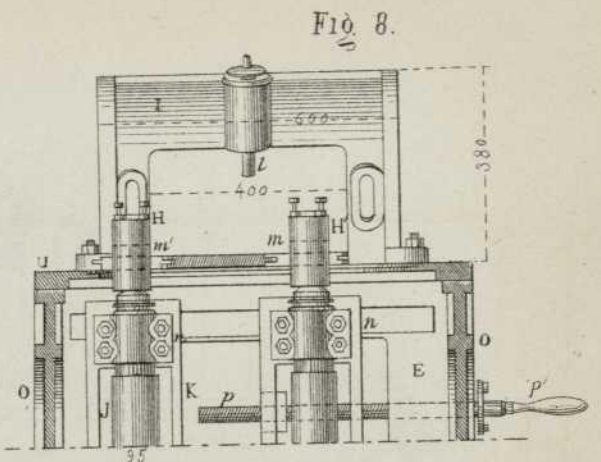
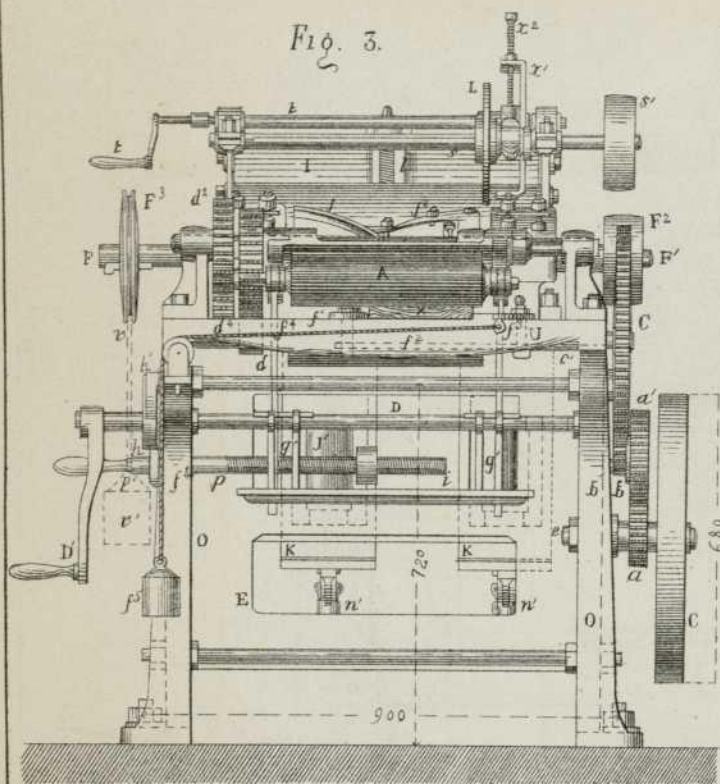


Fig. 7.

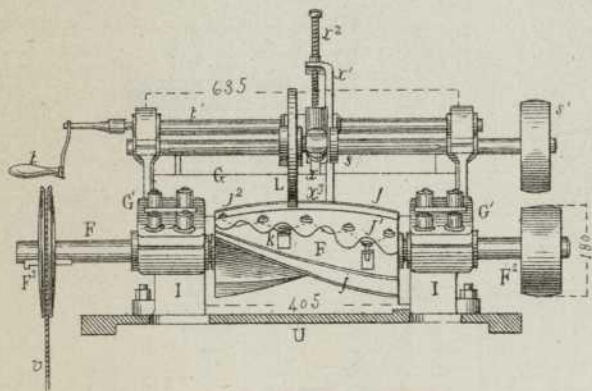


Fig. 4.

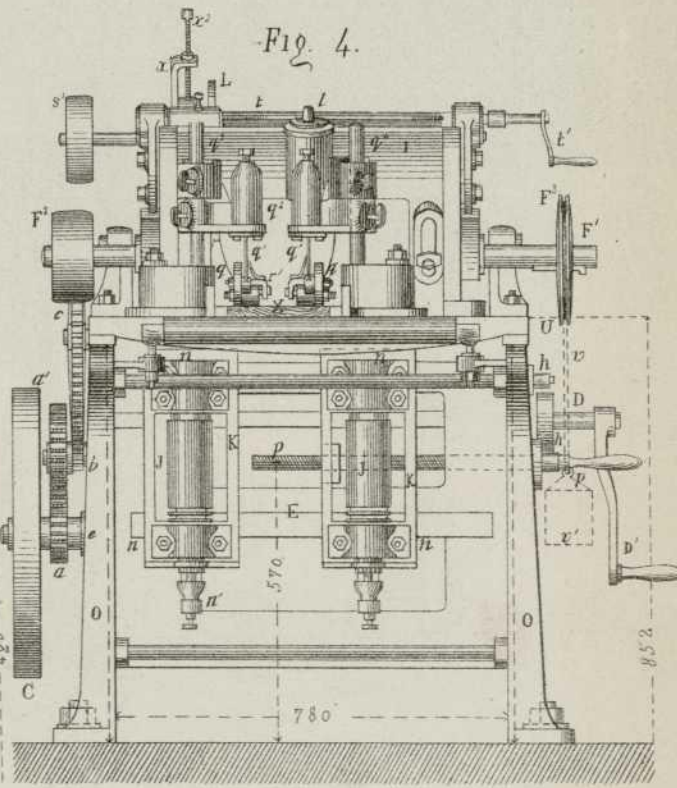


Fig. 5.

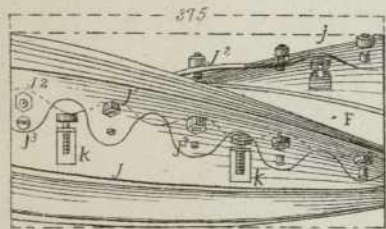
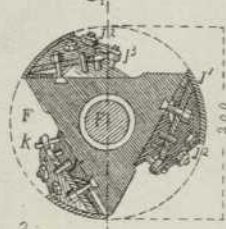
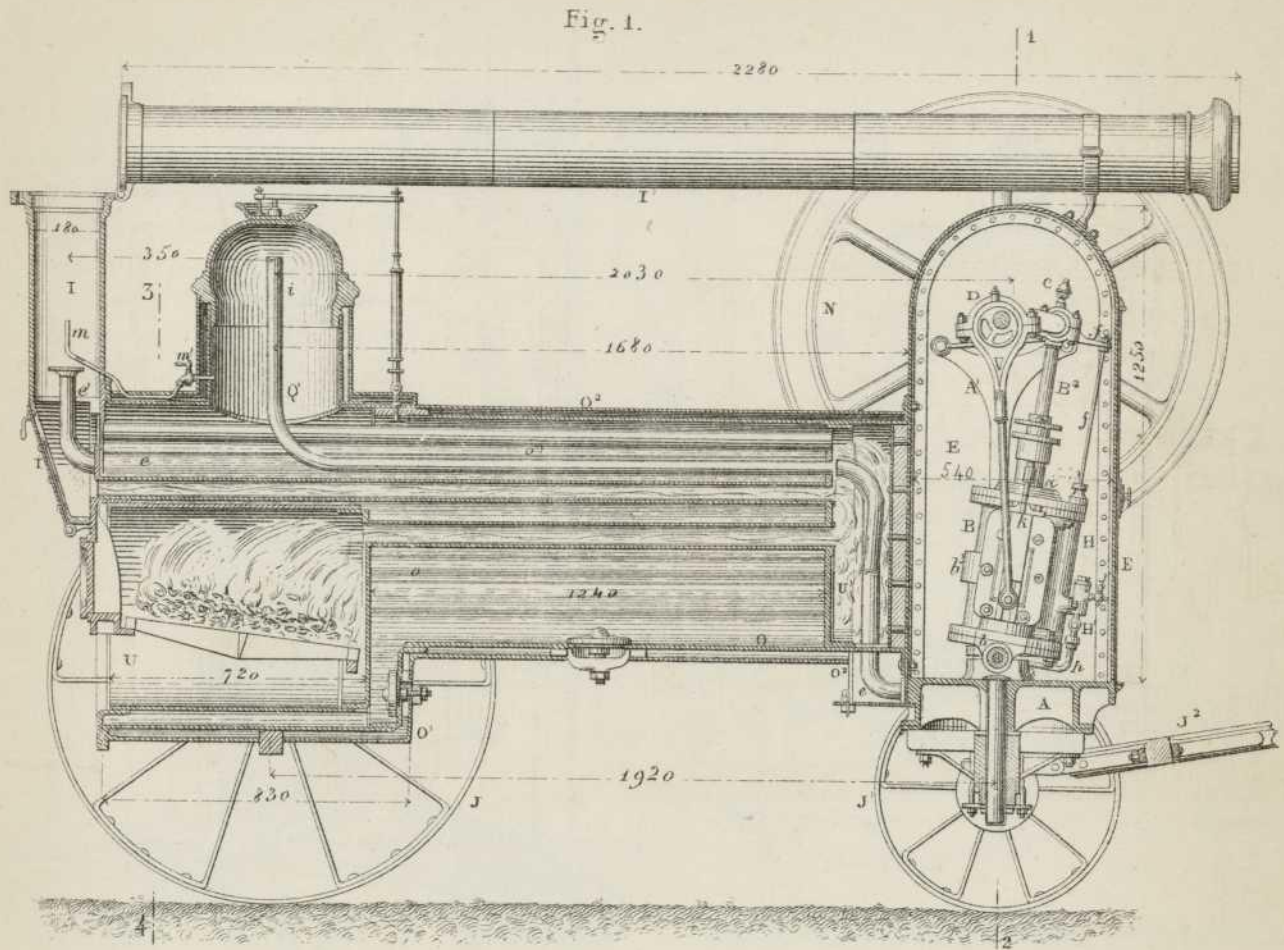


Fig. 6.



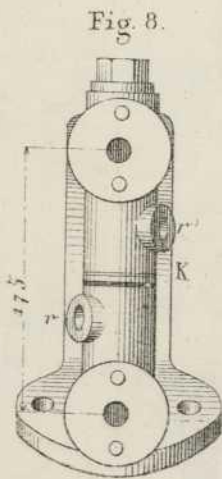
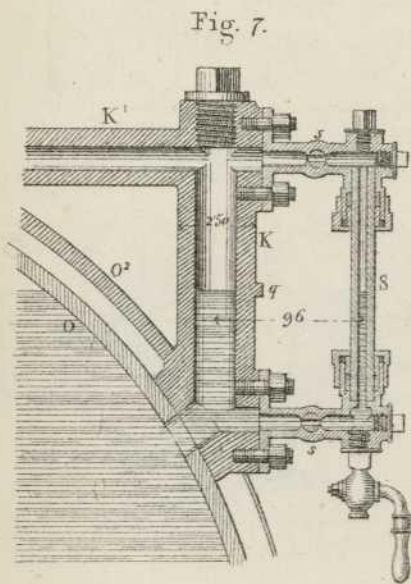
Escala de $\frac{1}{2}$ s por las Fig 1 à 4 y 7 à 9.



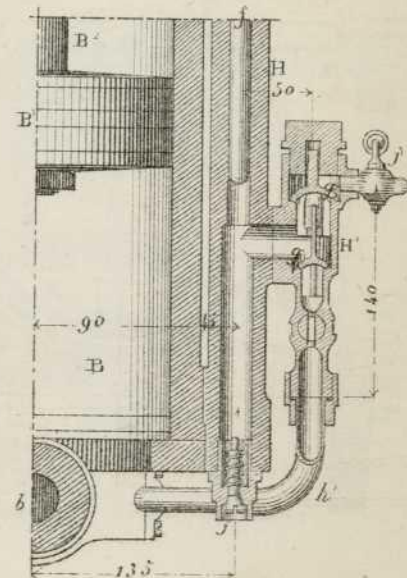
Escala de $\frac{1}{20}$ por las Fig. 1 à 3

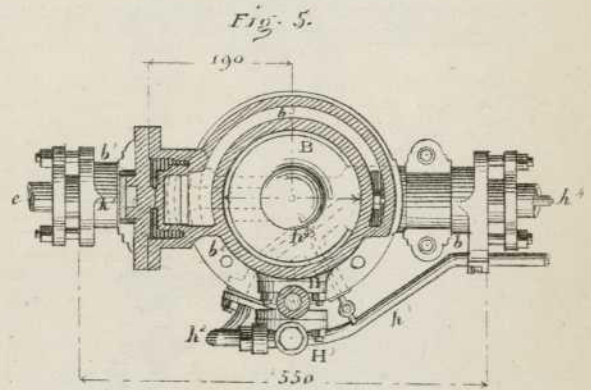
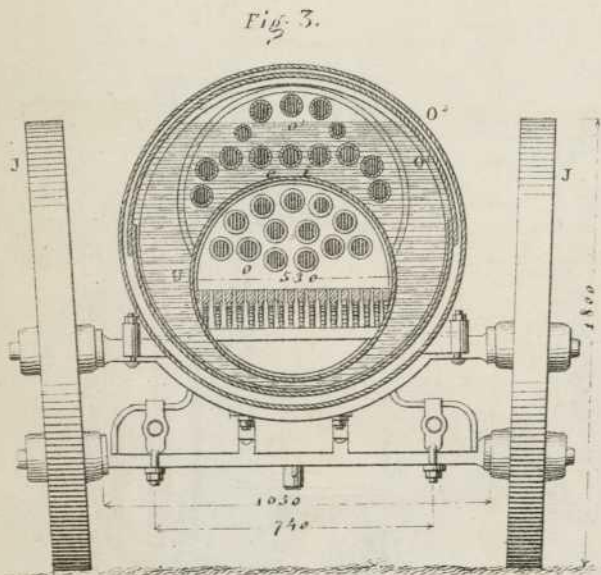
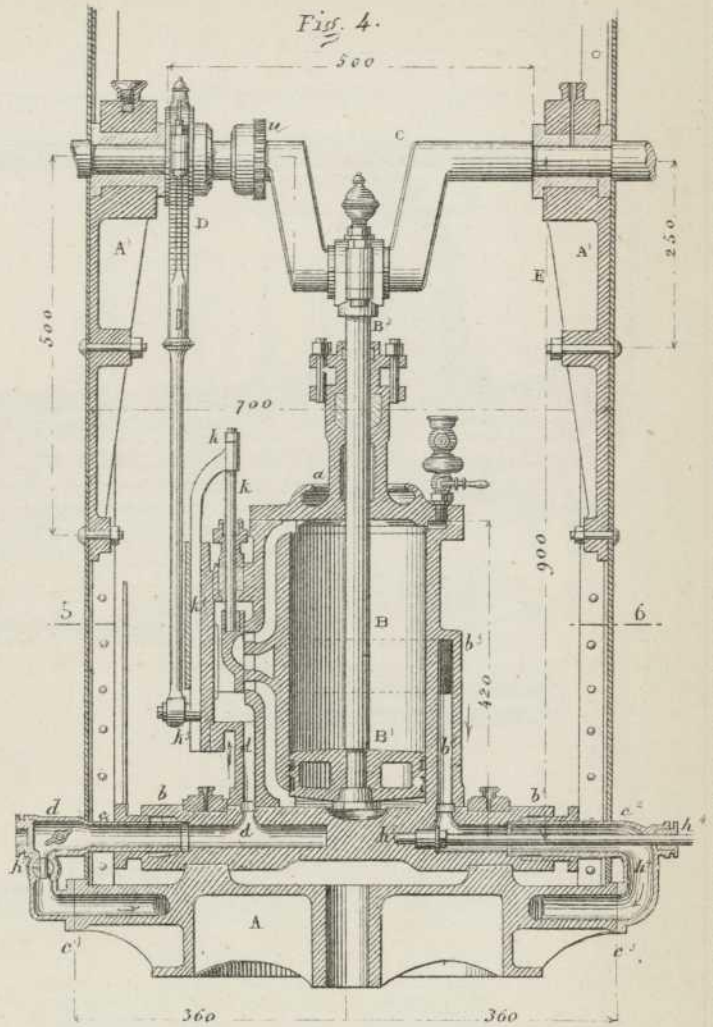
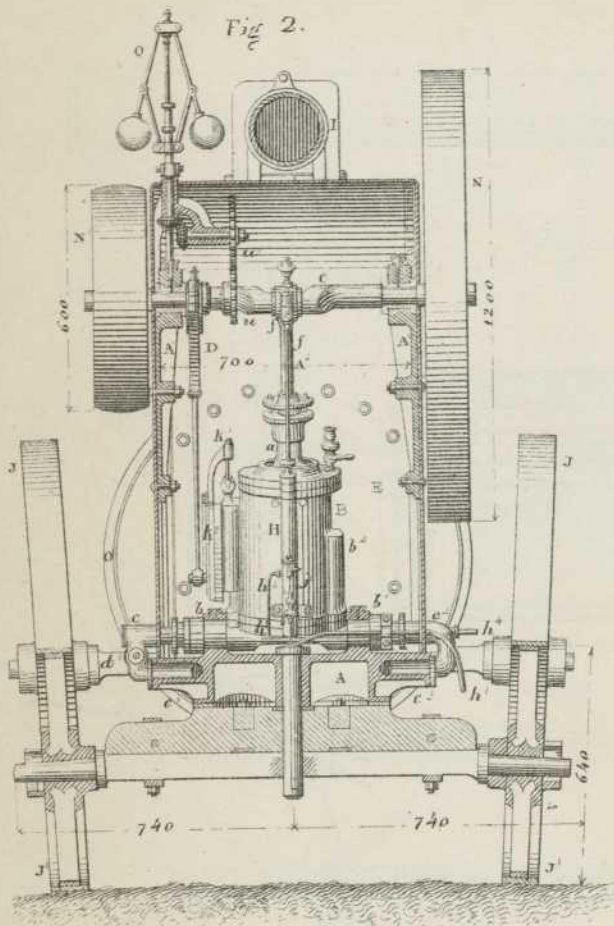
Potencia 8 caballas.

Fig. 6.



Escala de $\frac{1}{15}$





Escala de $\frac{1}{10}$ por las Fig 4 y 5

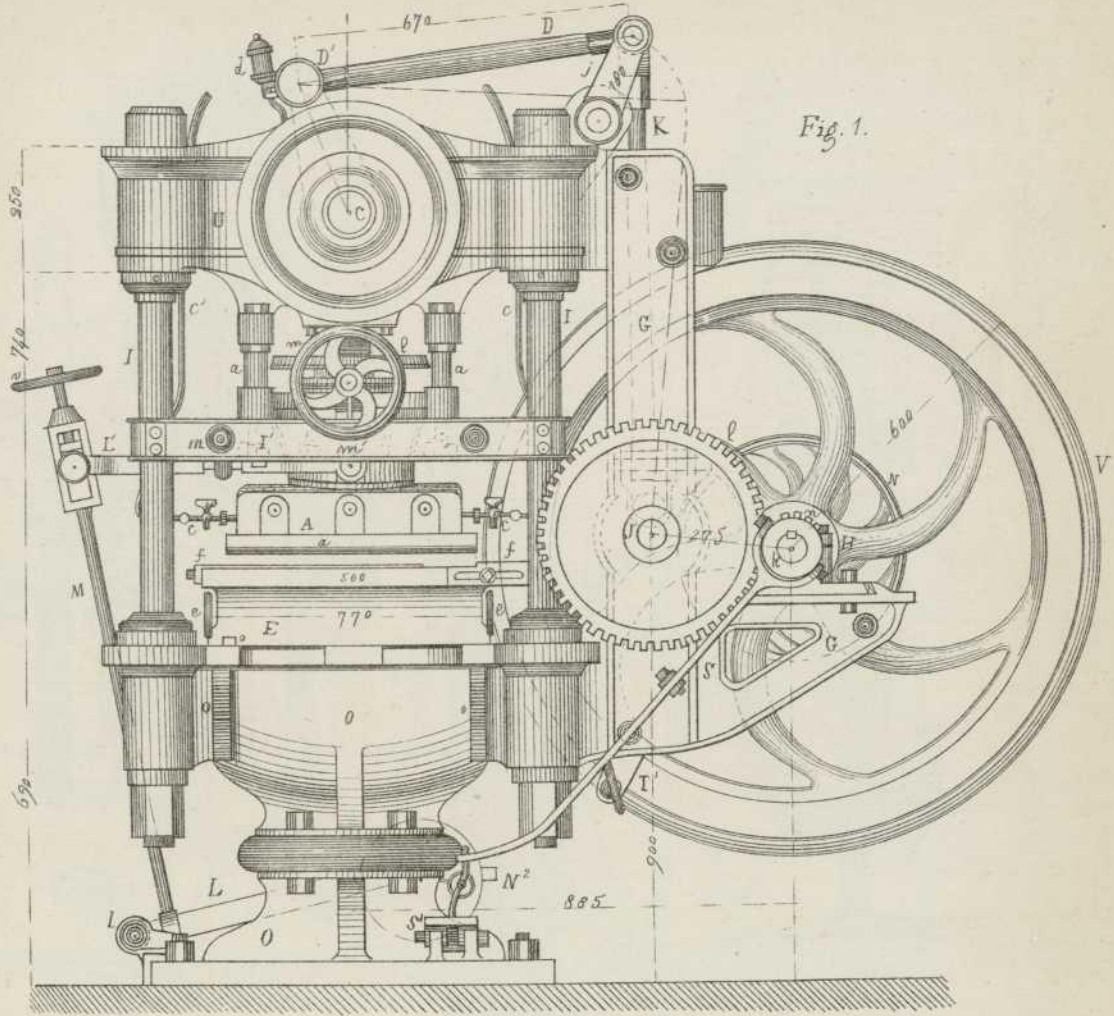


Fig. 1.

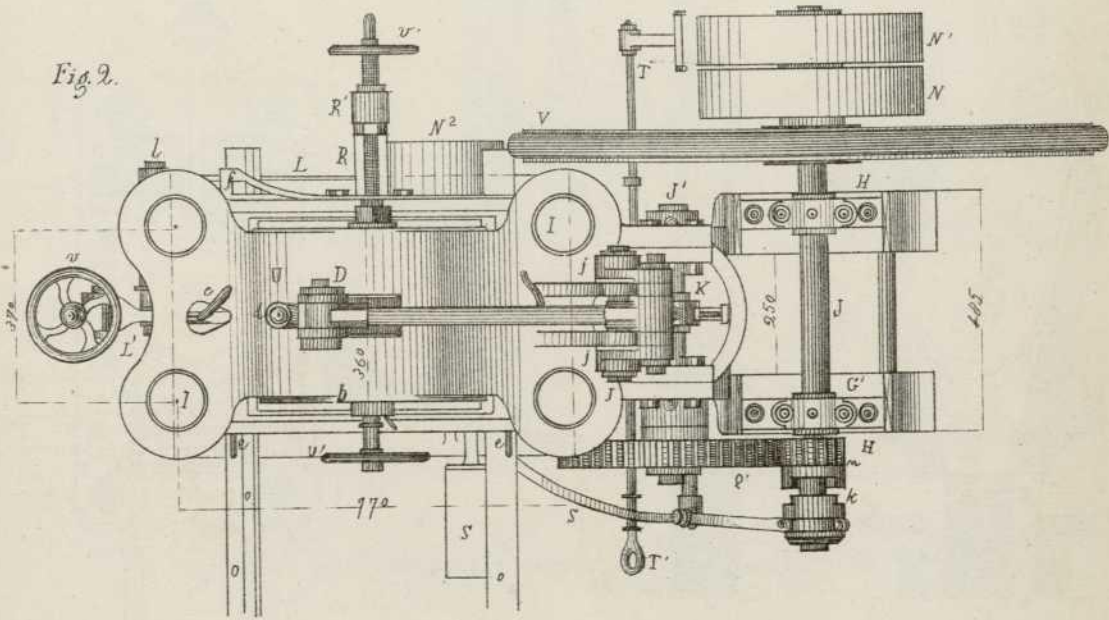
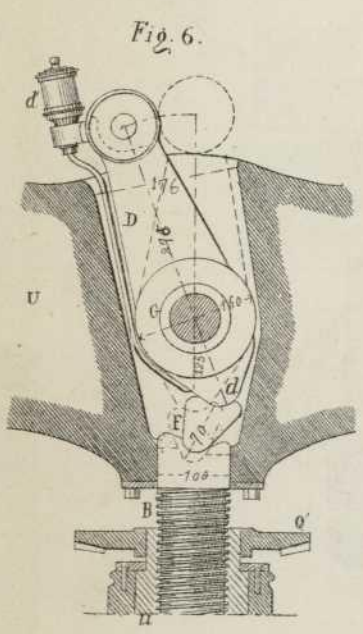
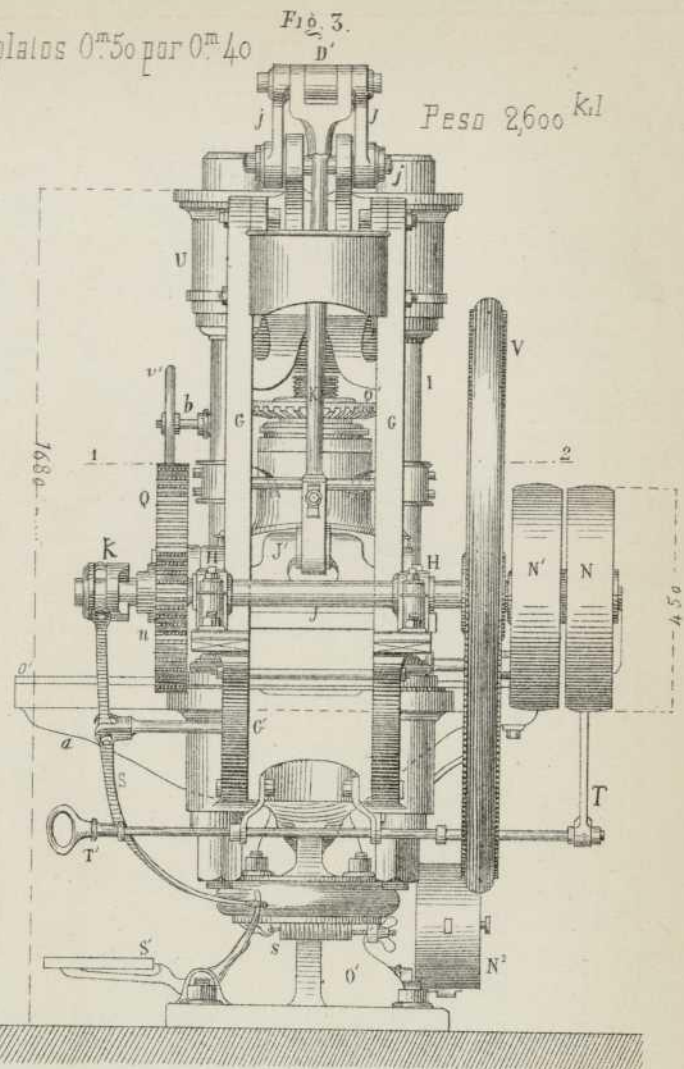
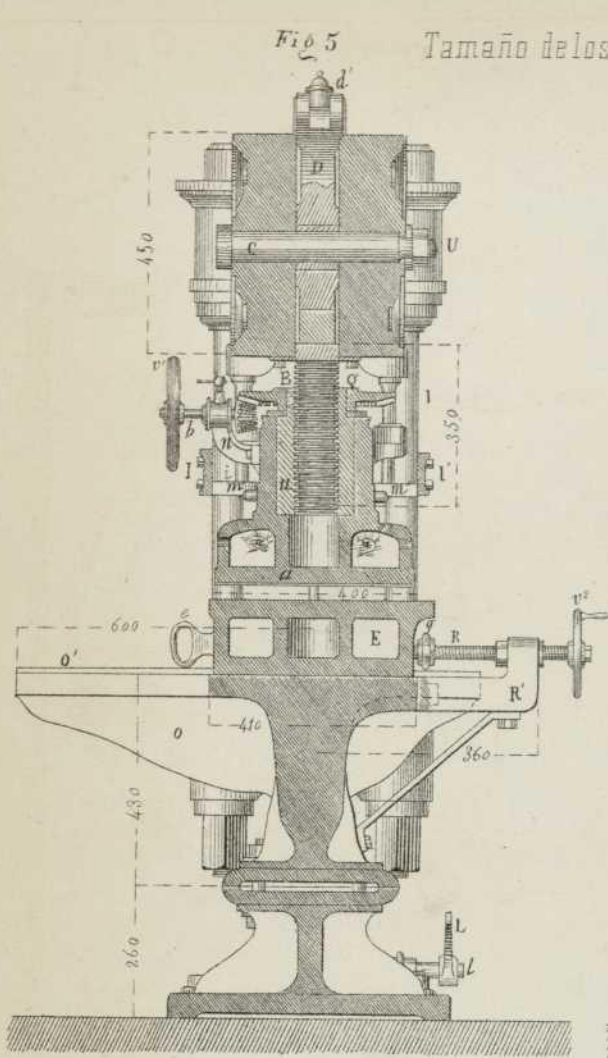
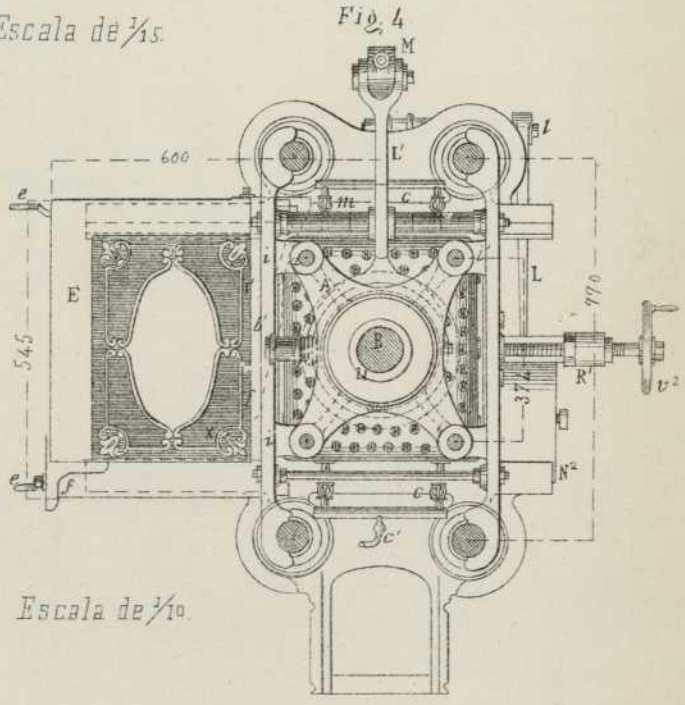


Fig. 2.



Escala de 1/15.



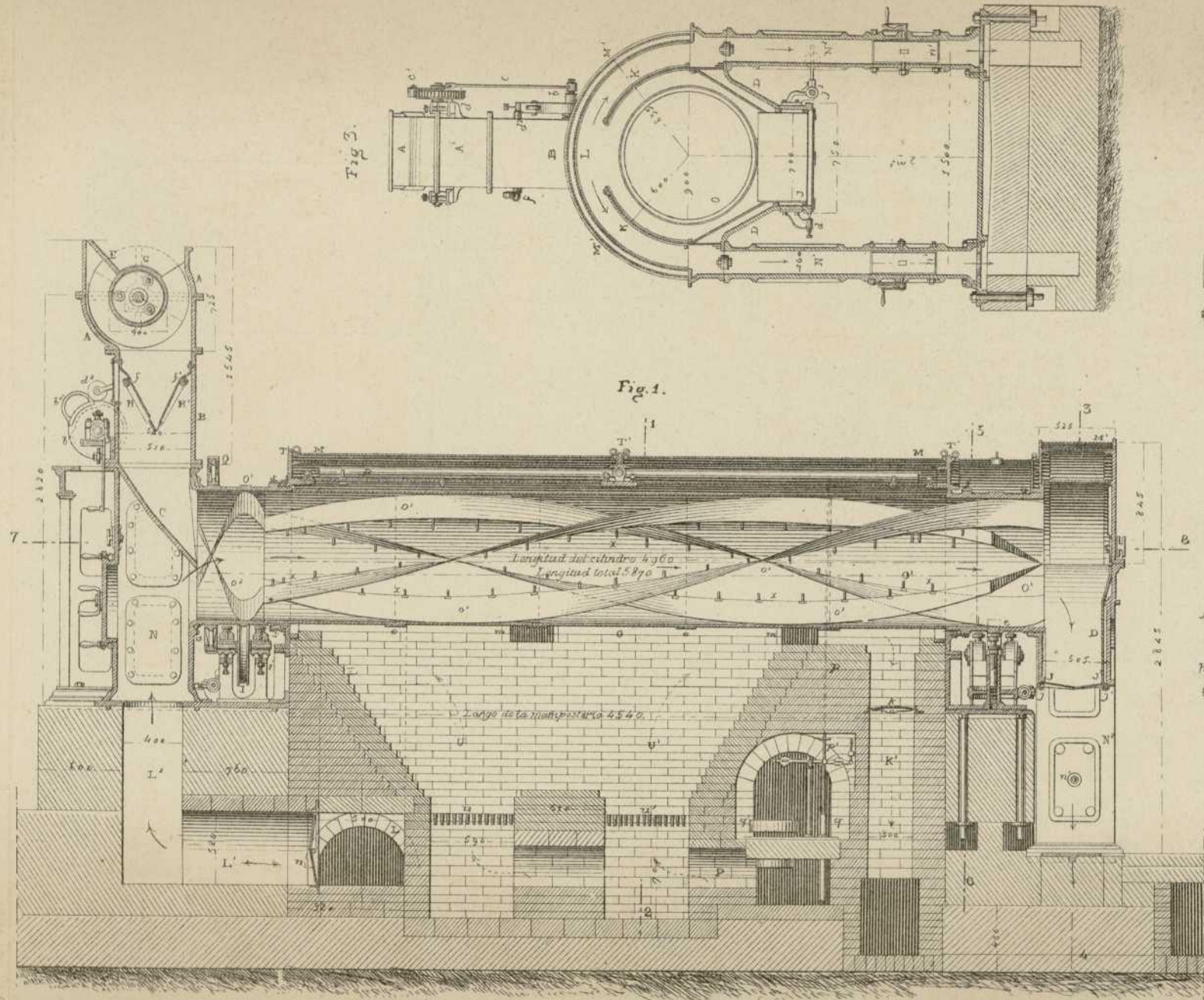


Fig. 3.

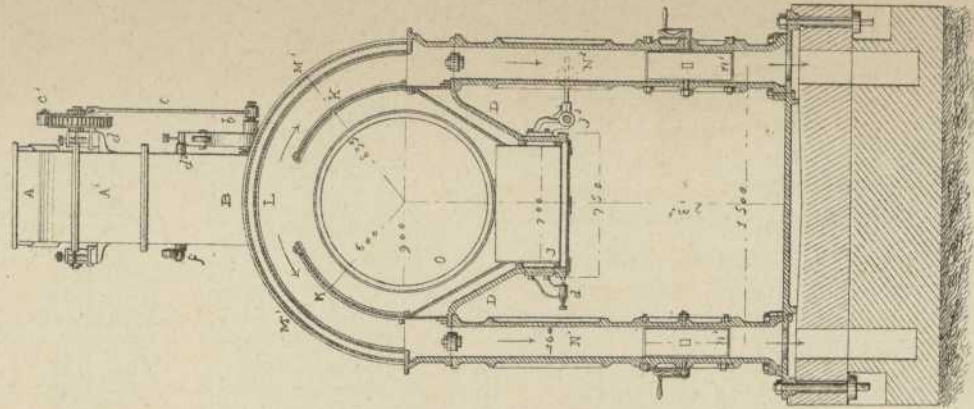


Fig. 6.

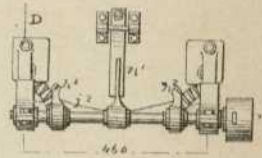
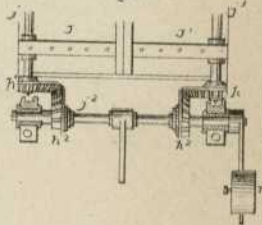


Fig. 1.

Fig. 8.



Dr. Nacente, editor.

Escala de $\frac{1}{20}$ por las Fig. 6 á 9.

Paseo de Gracia, 149.

Fig. 5

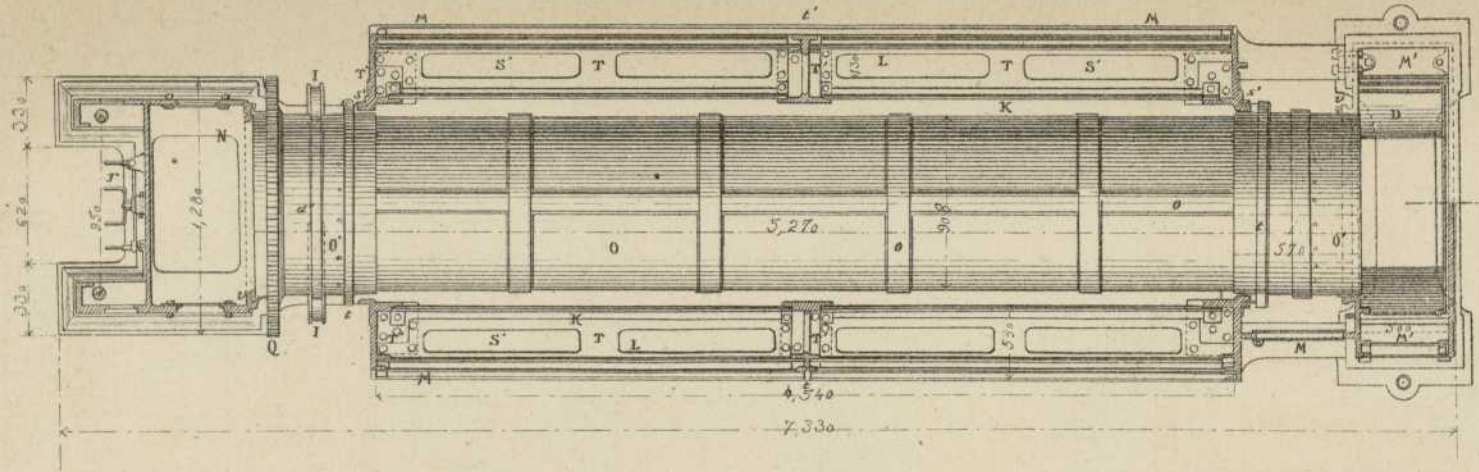


Fig. 2

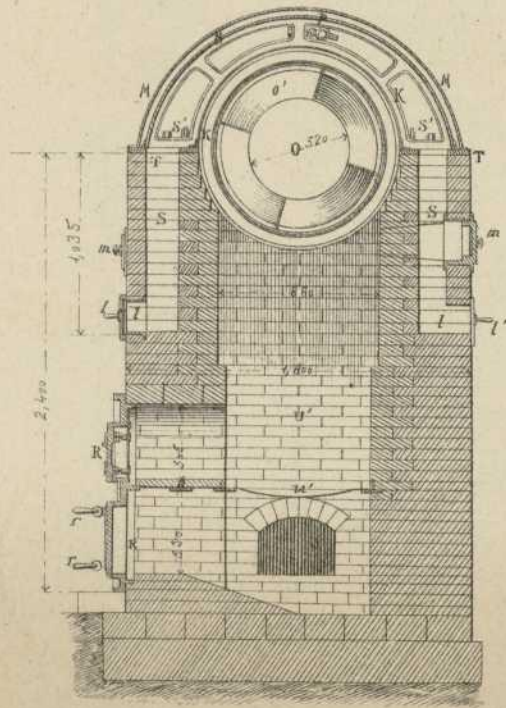


Fig. 4

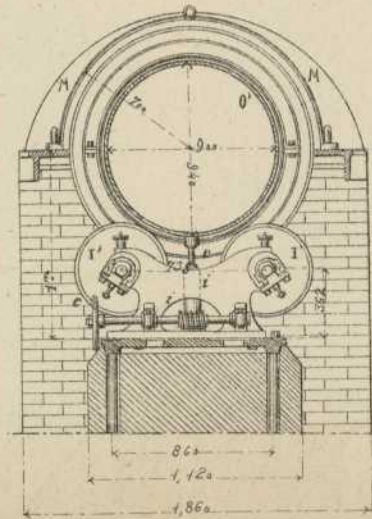


Fig. 7

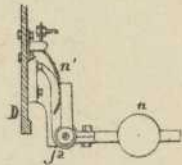
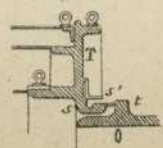


Fig. 9



Escala de 1/10 por las fig. 1 á 5.



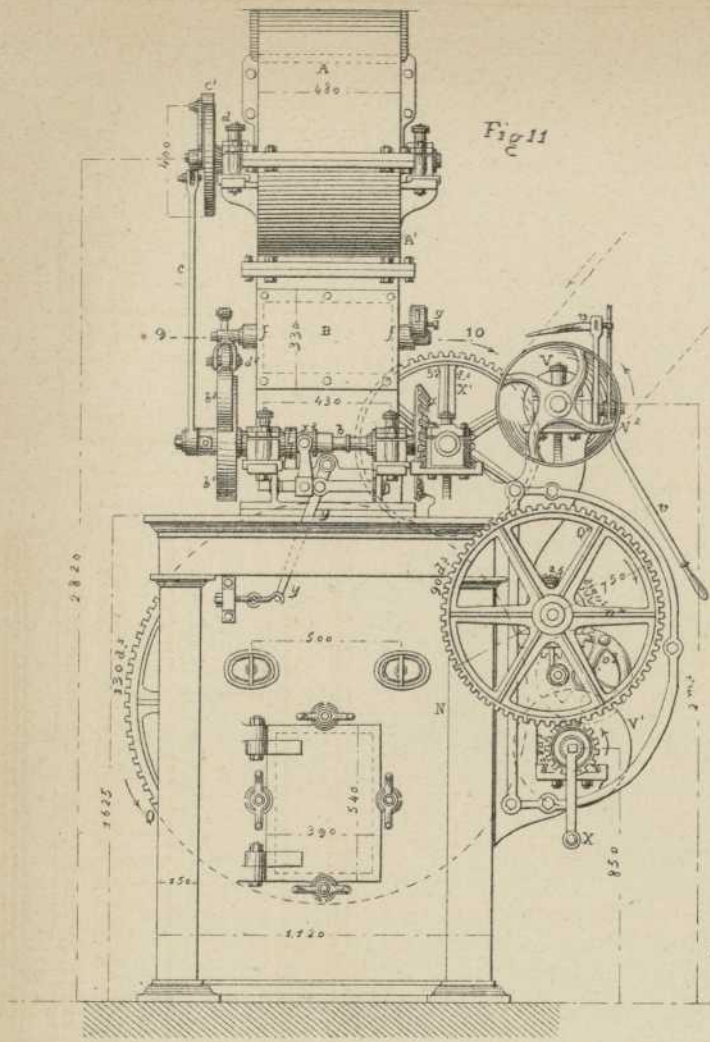


Fig. 11.

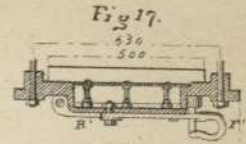


Fig. 17.

Fig. 16.

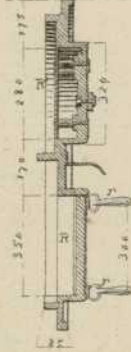


Fig. 15.

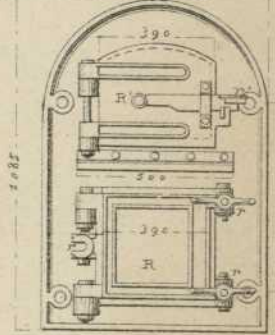


Fig. 18.

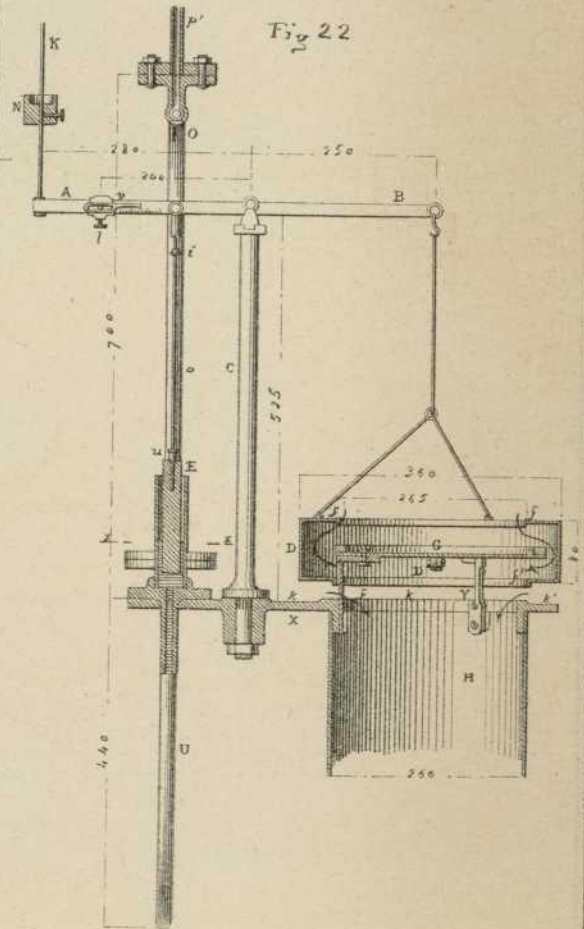
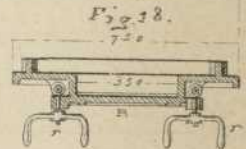


Fig. 22.

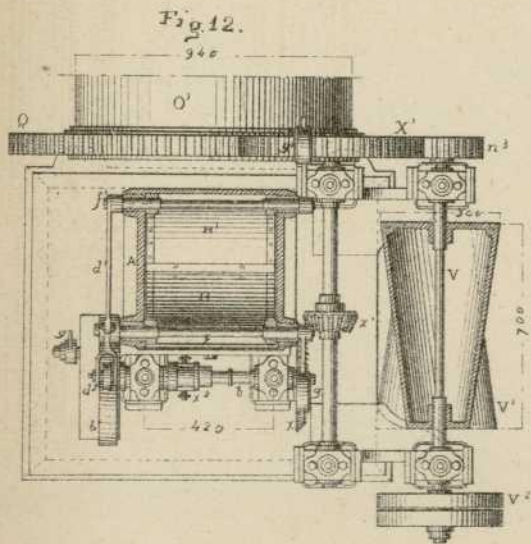


Fig. 12.

Escala de 1/20 por las Fig. 15 à 21.

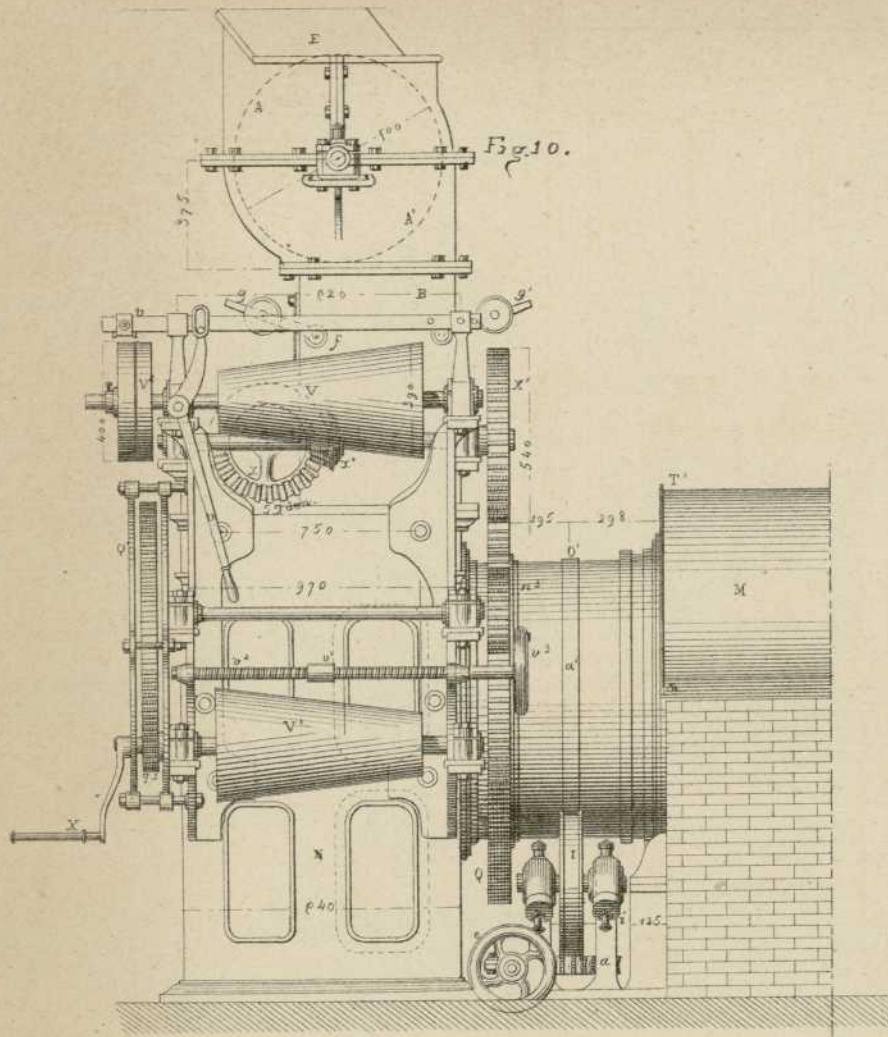


Fig. 23.

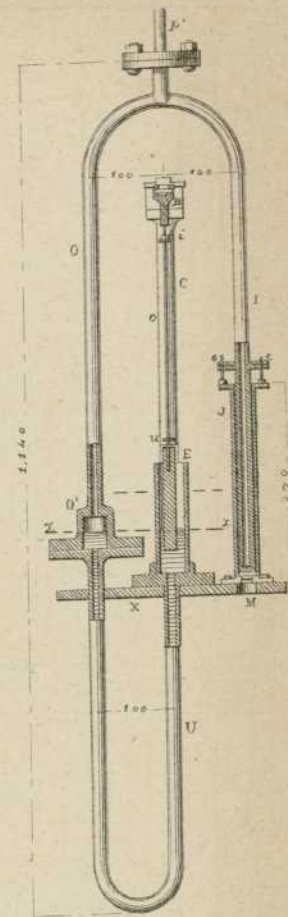


Fig. 14.

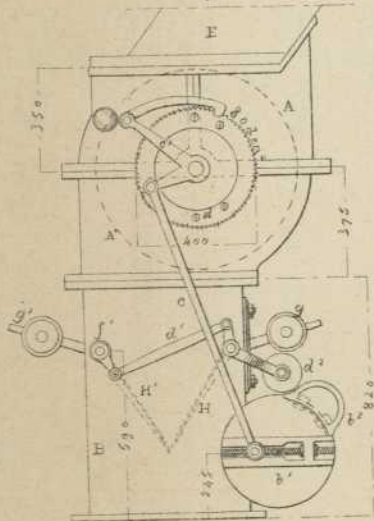


Fig. 13.

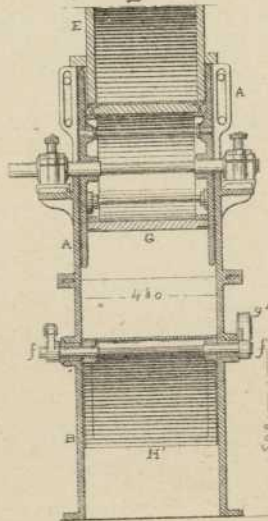


Fig. 19.

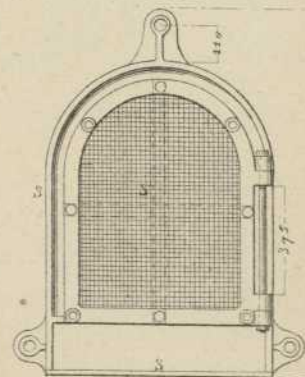


Fig. 20.

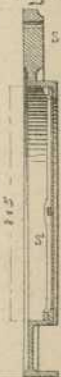
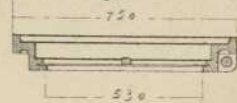


Fig. 21.



Escala de 1/10 por las Fig. 22 y 23.

Fig. 30

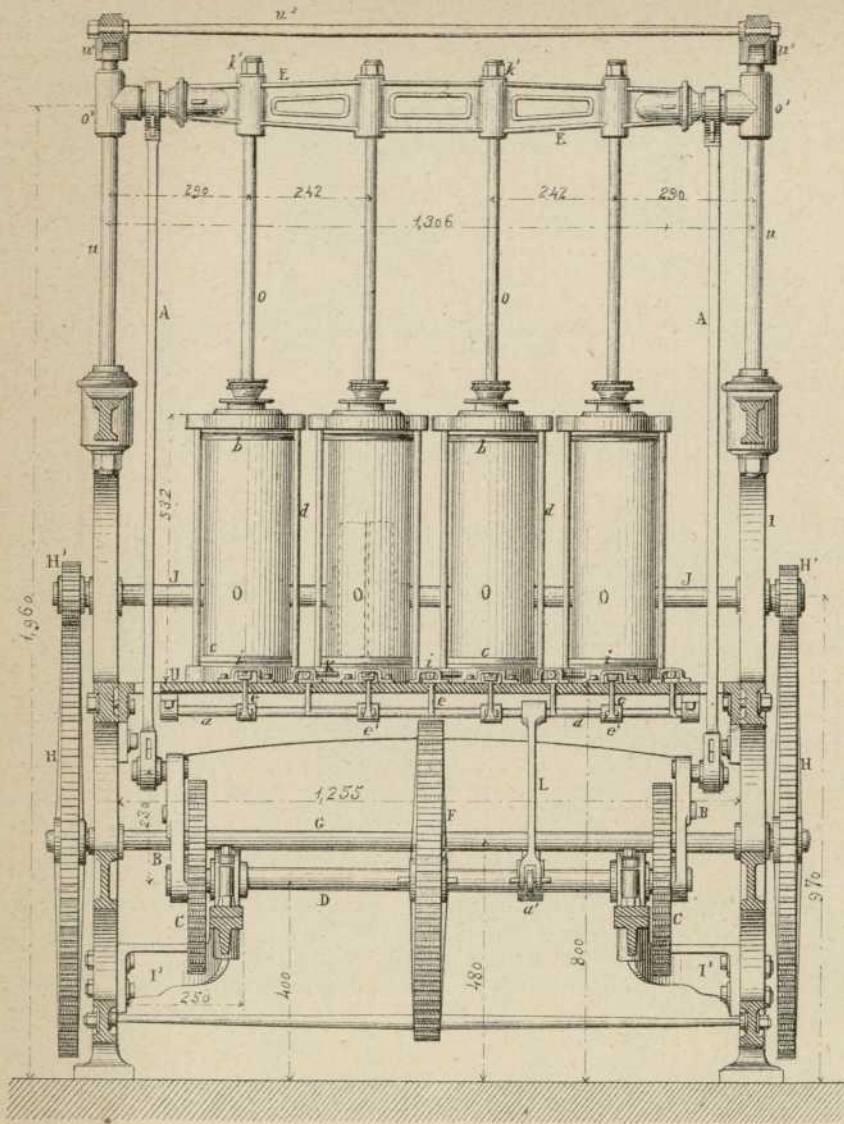


Fig. 32

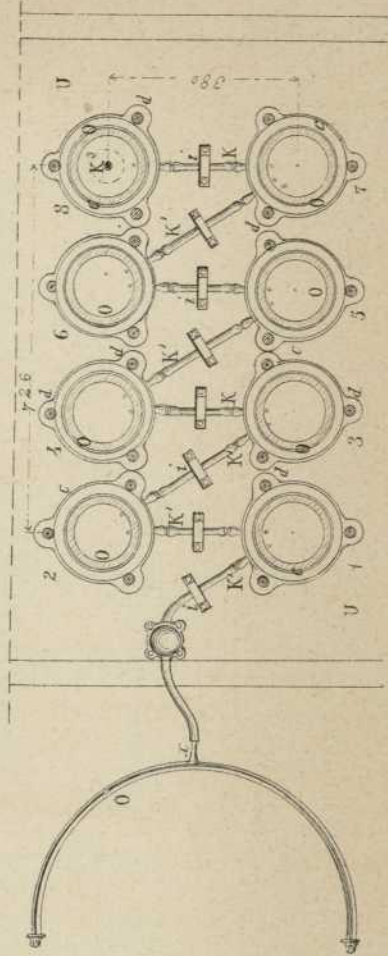


Fig. 39

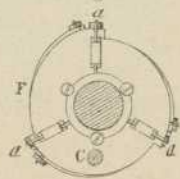


Fig. 38

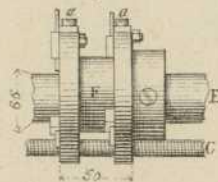
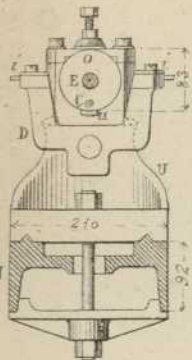
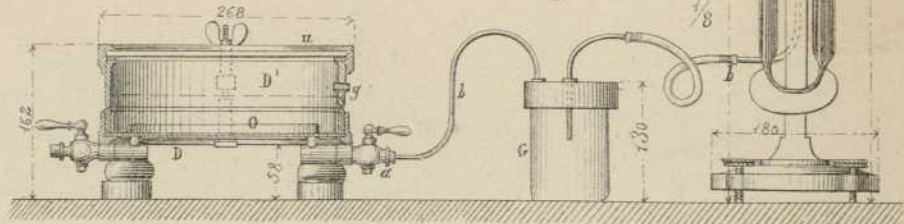


Fig. 37



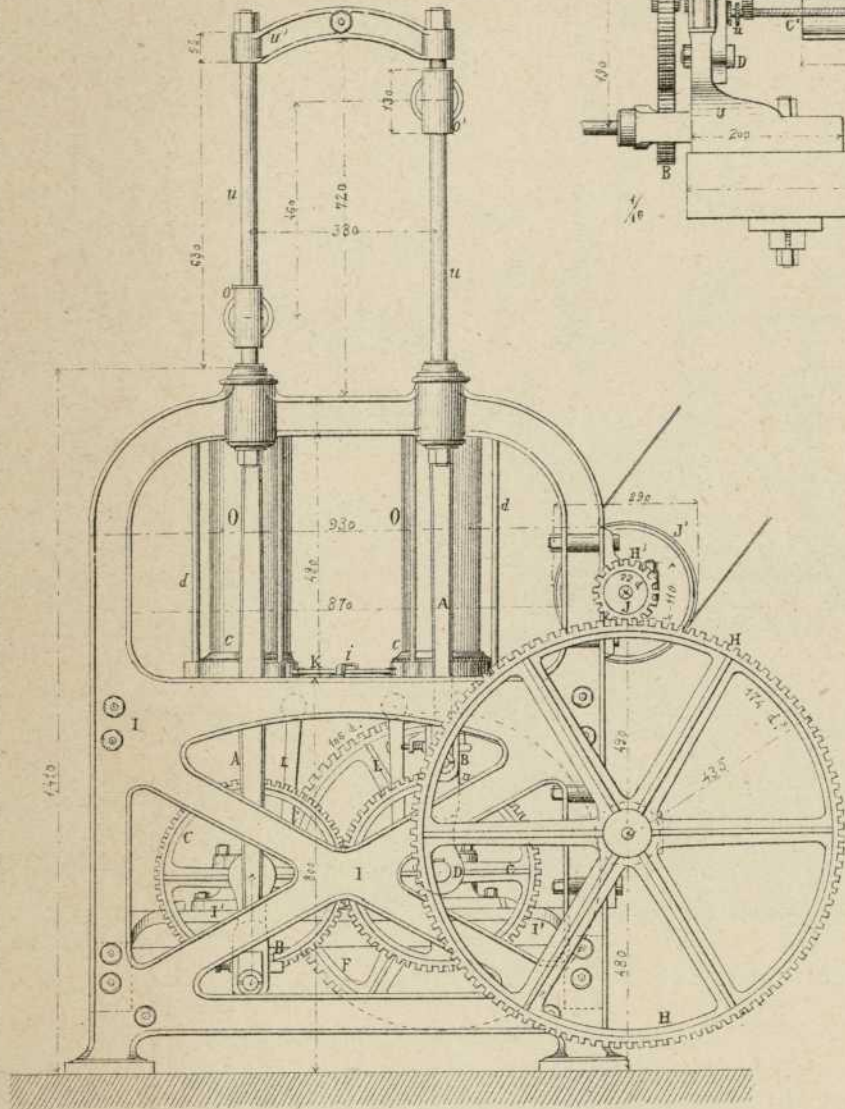
Escala de 1/5 por las Fig. 30 à 32

Fig. 26



NOTA. Esta lámina y las tres siguientes van esplicadas á continuacion de las que llevan los números 195 y 196.

Fig. 31



Escala de 1/6 por las Fig 26 y 27

Fig. 36

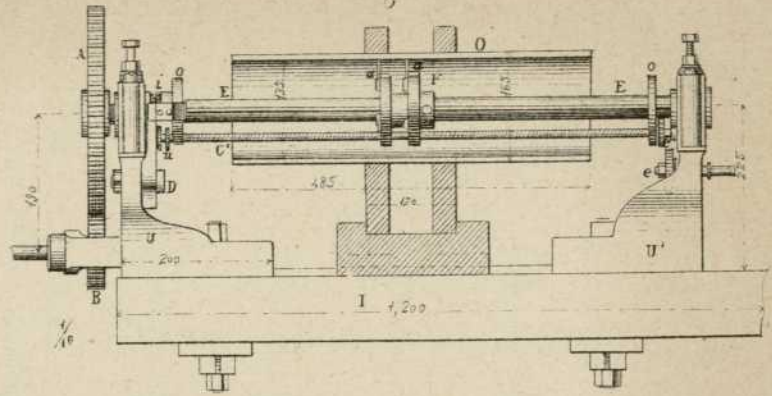


Fig. 34

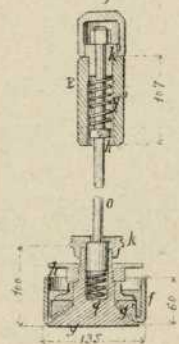


Fig. 35

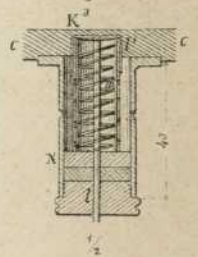


Fig. 29

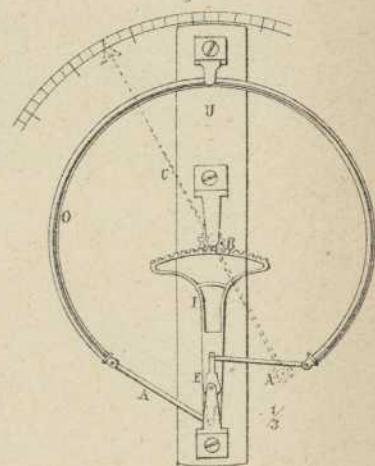


Fig. 33

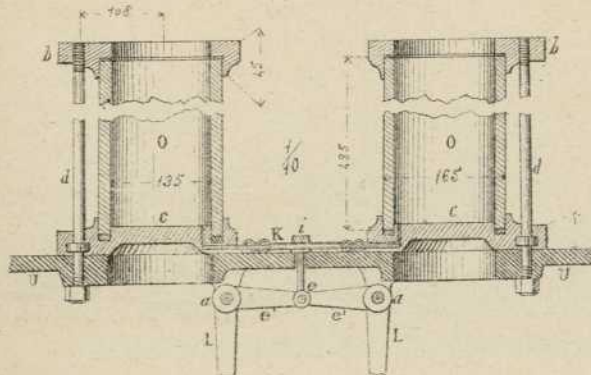


Fig. 27

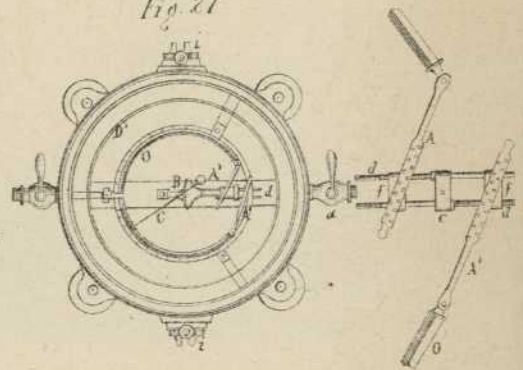


Fig. 41

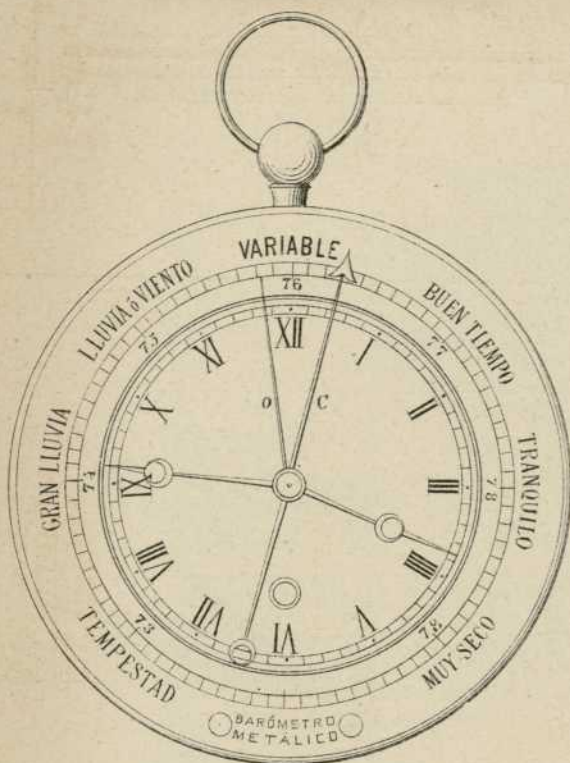


Fig. 42

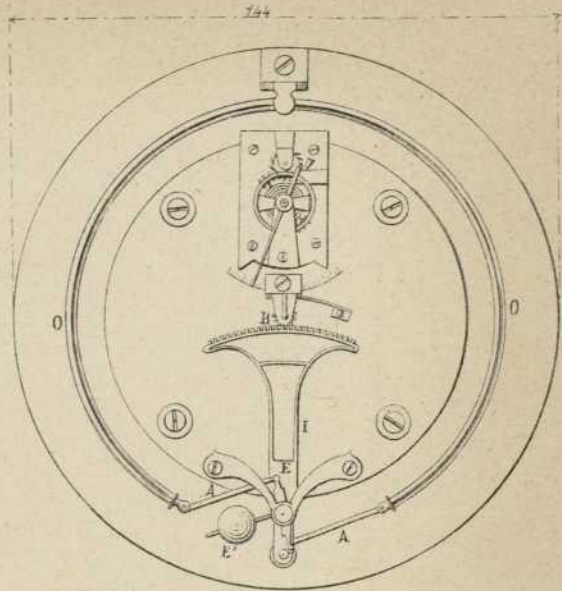


Fig. 46

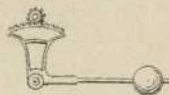


Fig. 40

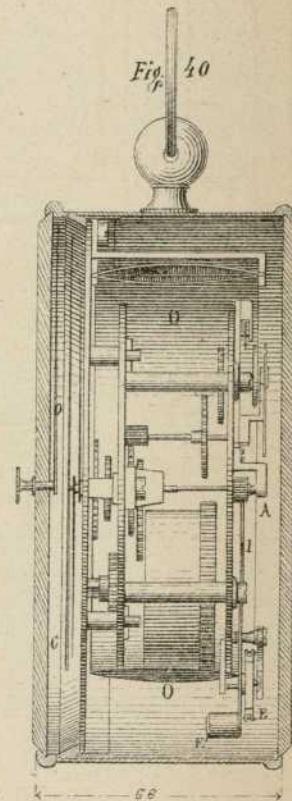


Fig. 45

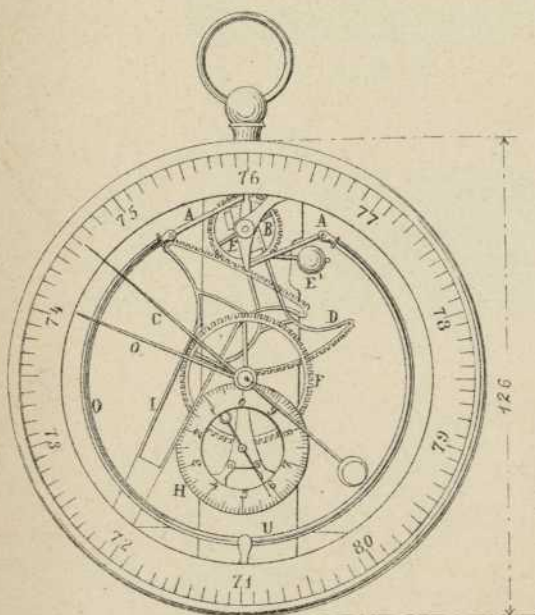


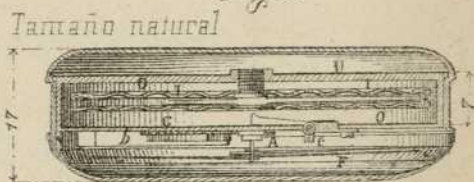
Fig. 52



Fig. 49



Fig. 51



Escala de 1/2 por las Fig. 40 à 45.

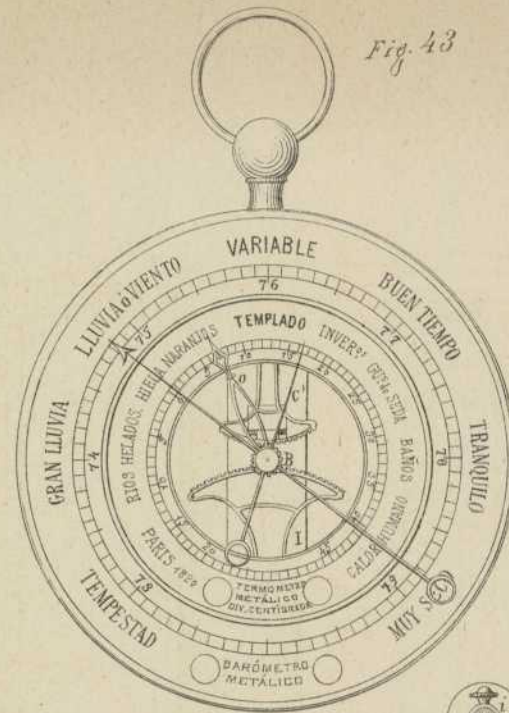
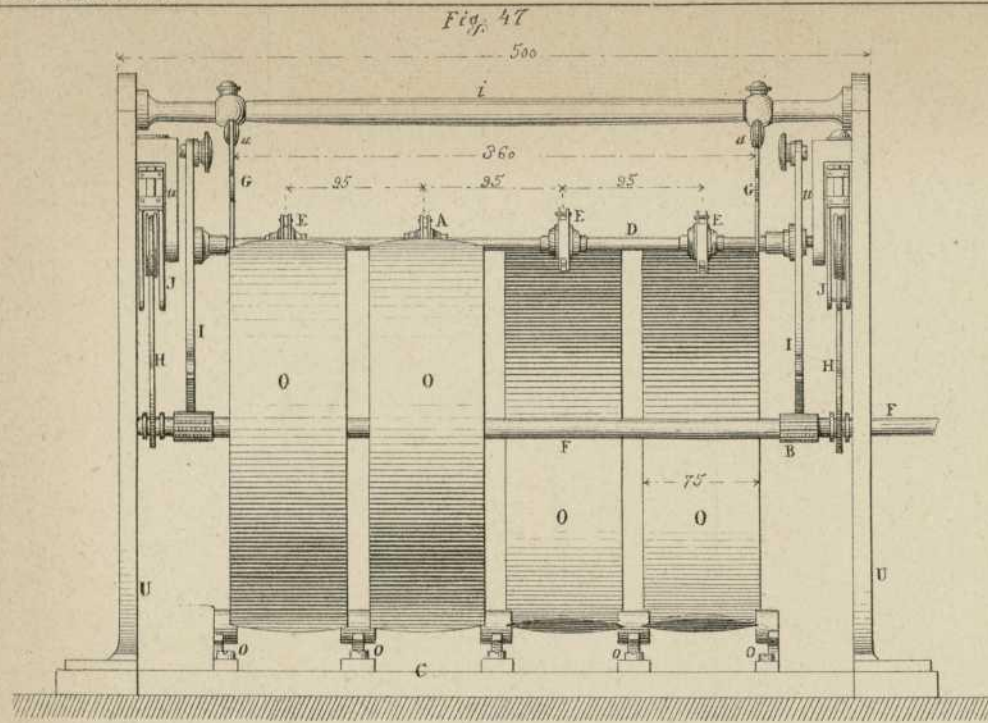


Fig. 44

Escala de 1/5.

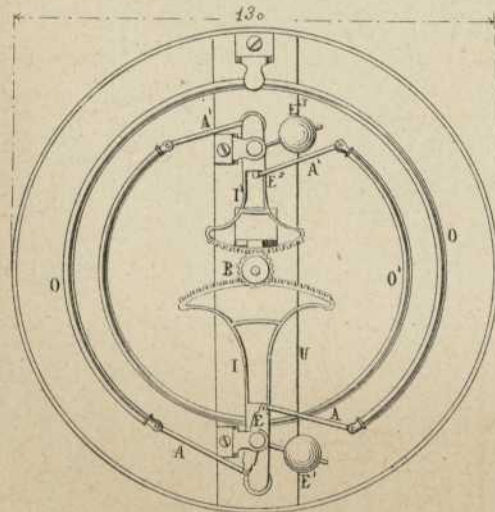


Fig. 50

Tamaño natural

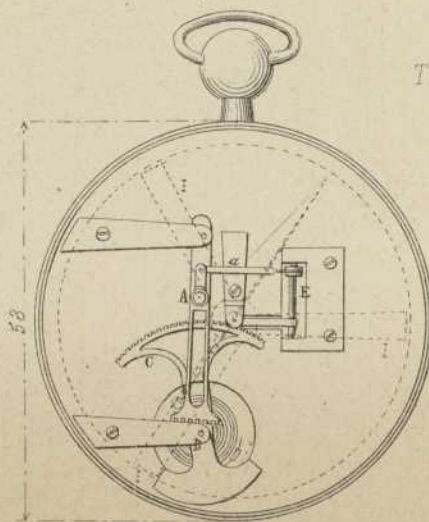
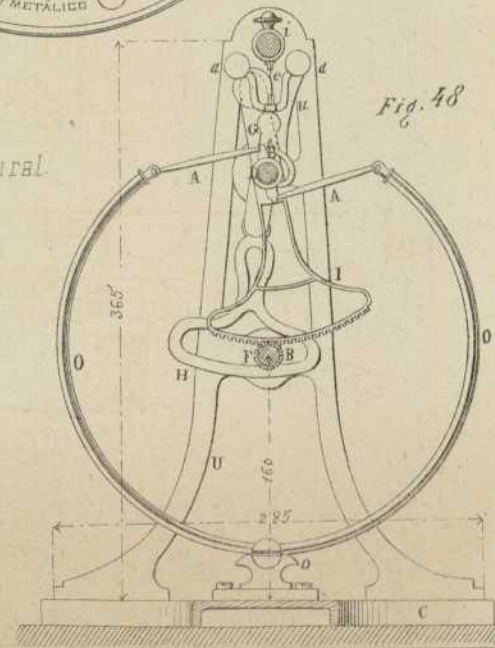
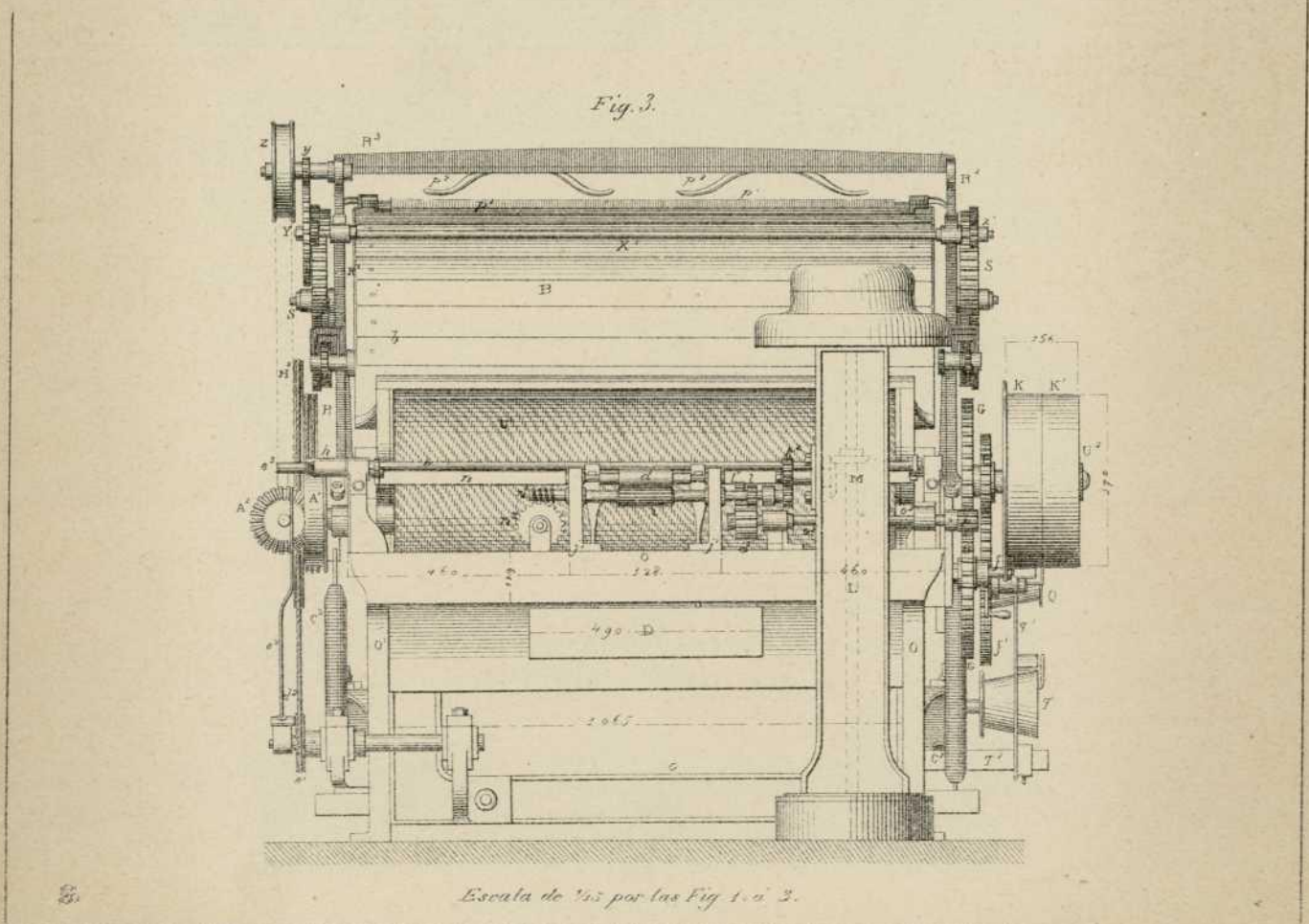
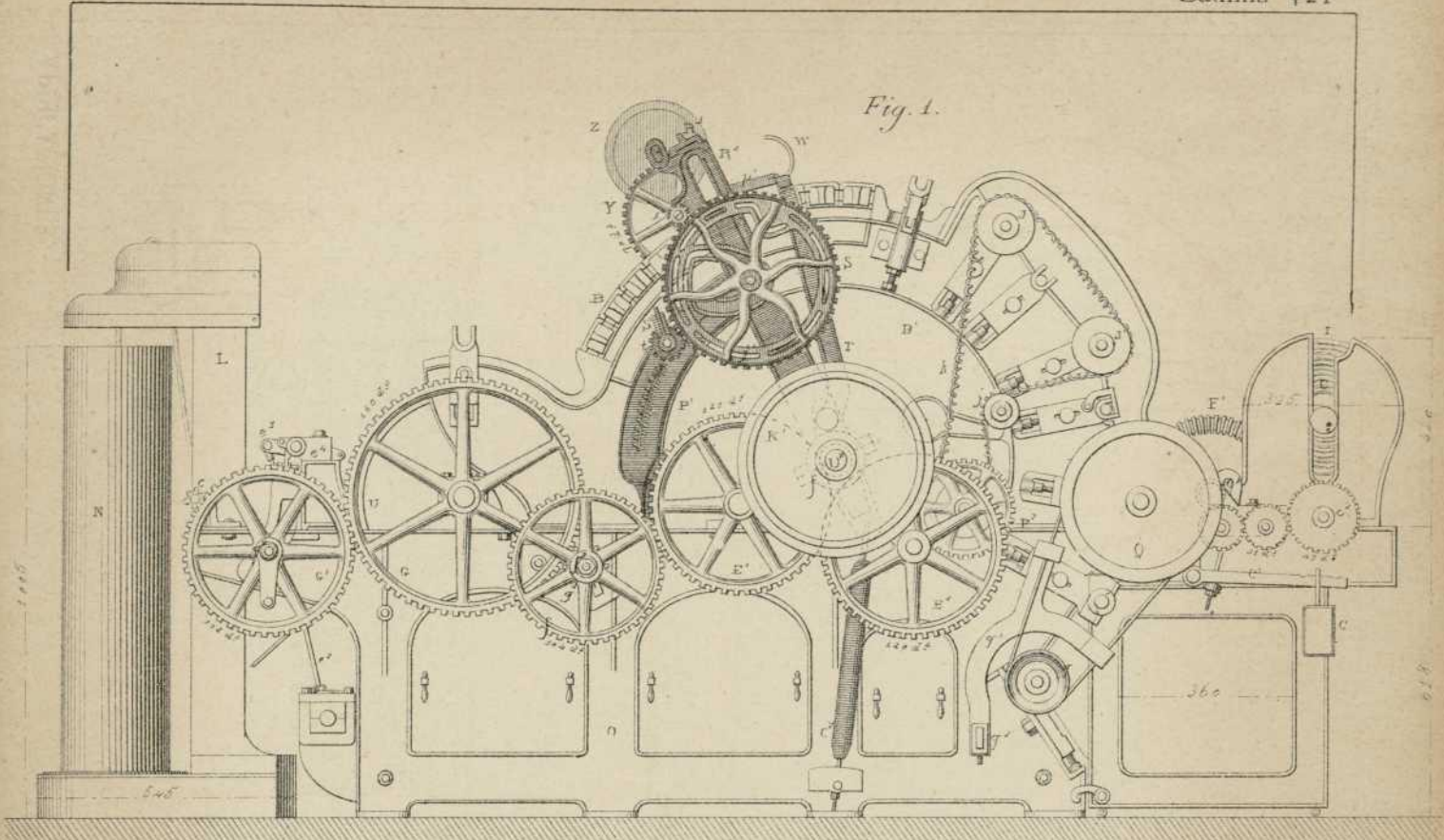


Fig. 48





Escala de 1/50 por las Fig 1. a 3.

Fig. 2.

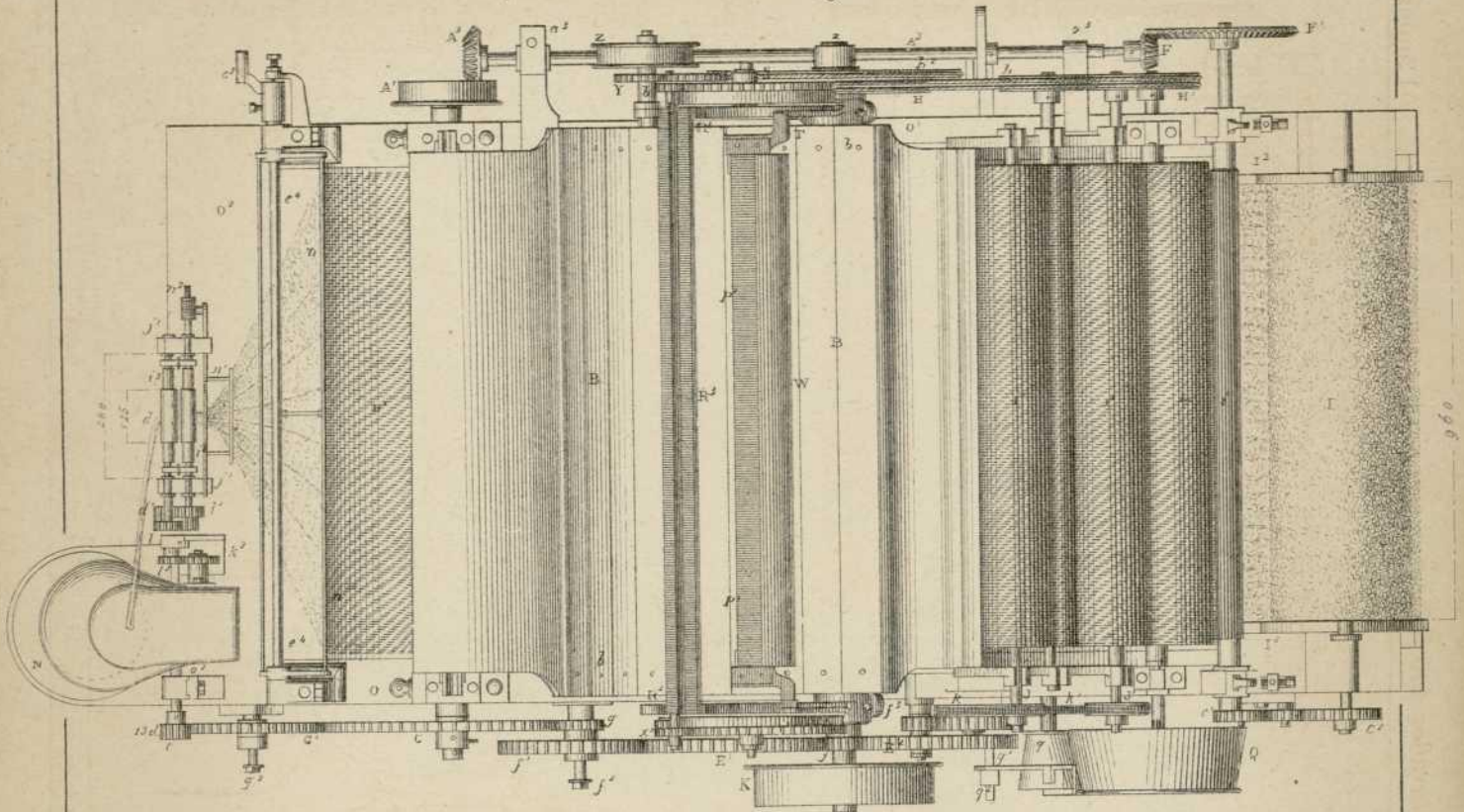
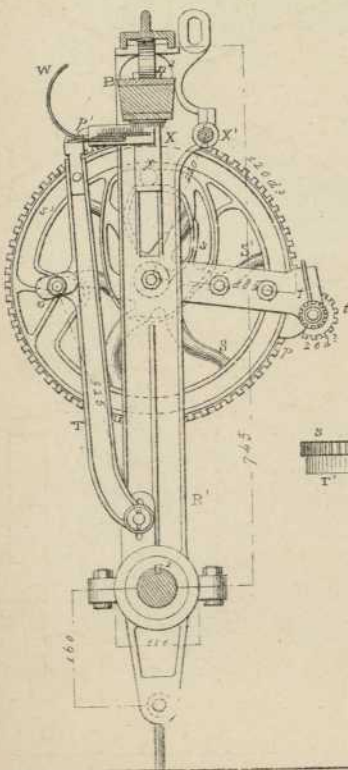


Fig. 12.



Escala de 1/10.

Fig. 14.

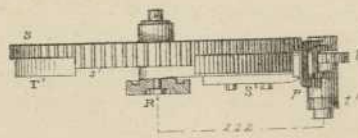
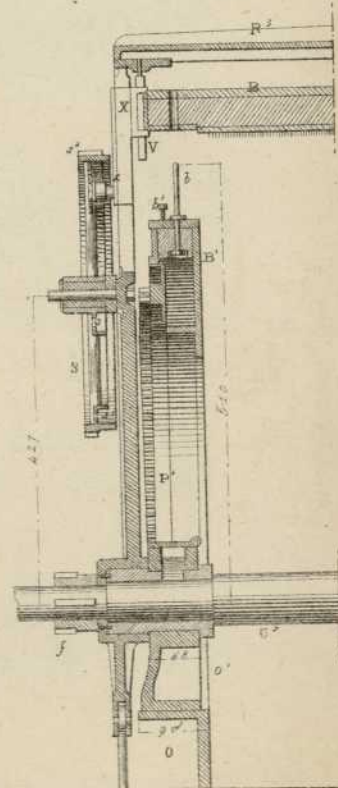
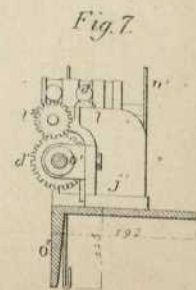
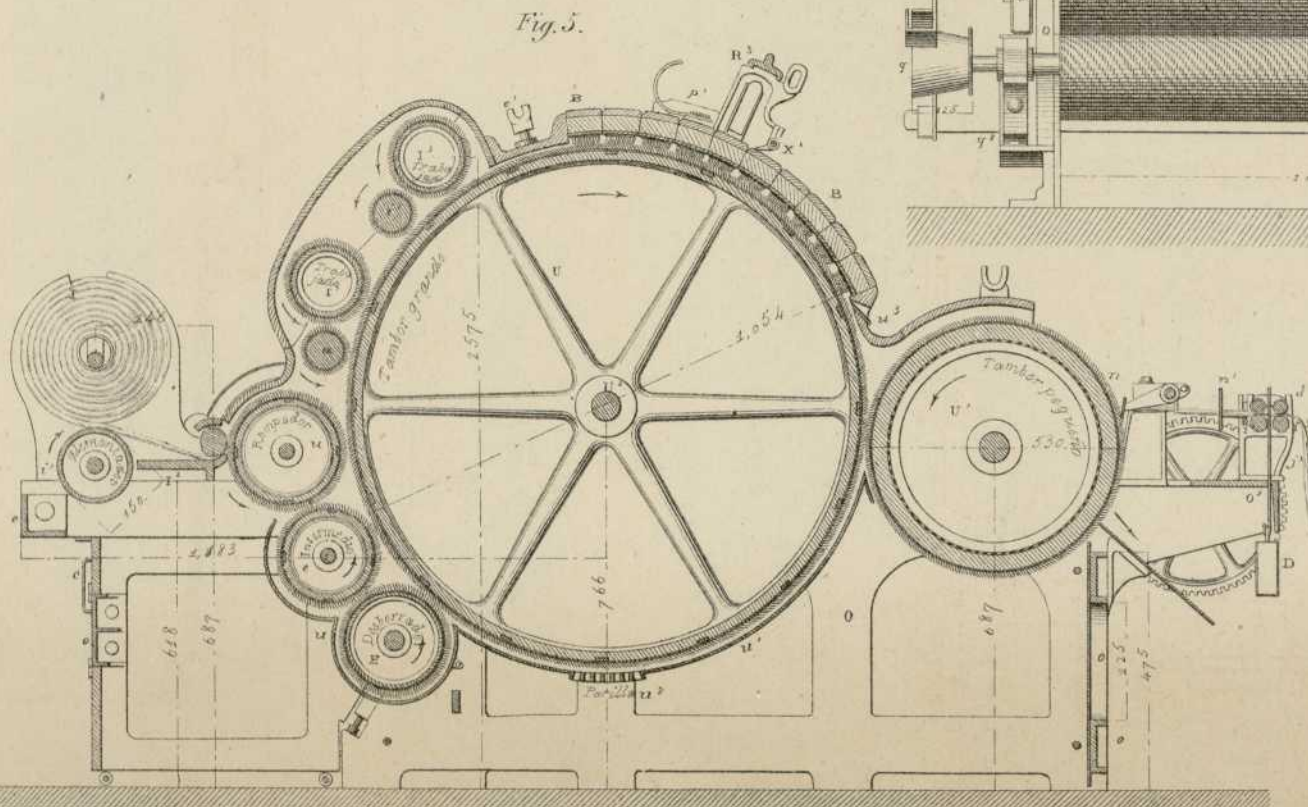
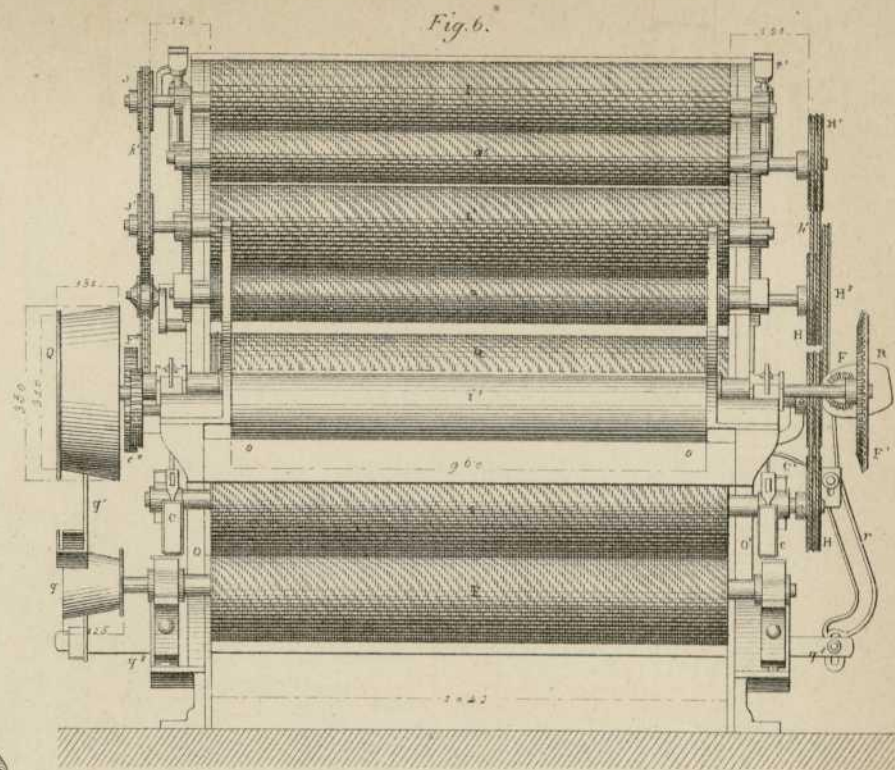
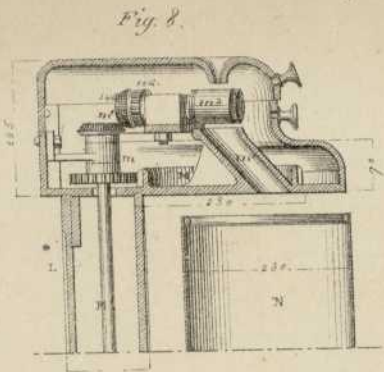


Fig. 13.





Escala de 1/15.

Fig. 10.

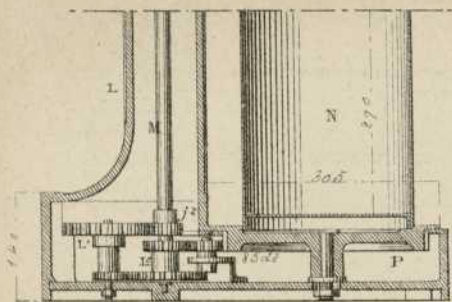


Fig. 11.

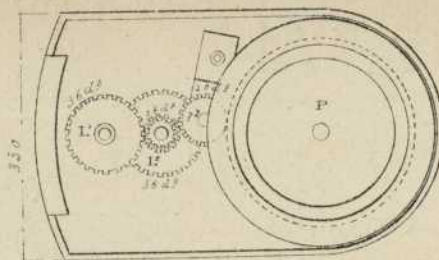


Fig. 9.

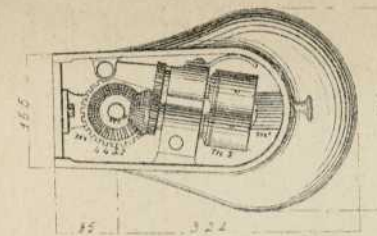
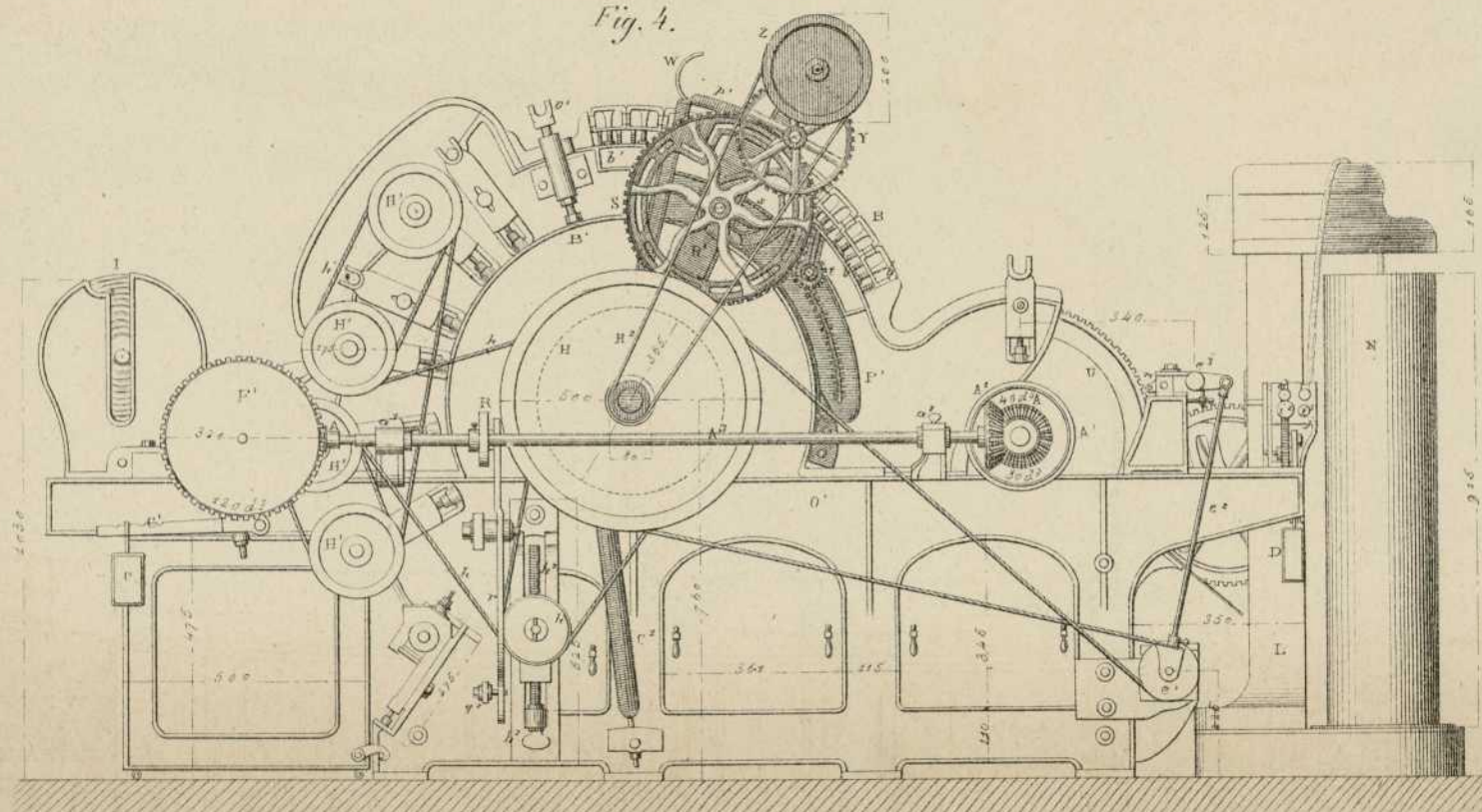


Fig. 4.



Escala de 1/10 por las Fig. 8 a 11.



Fig. 2.

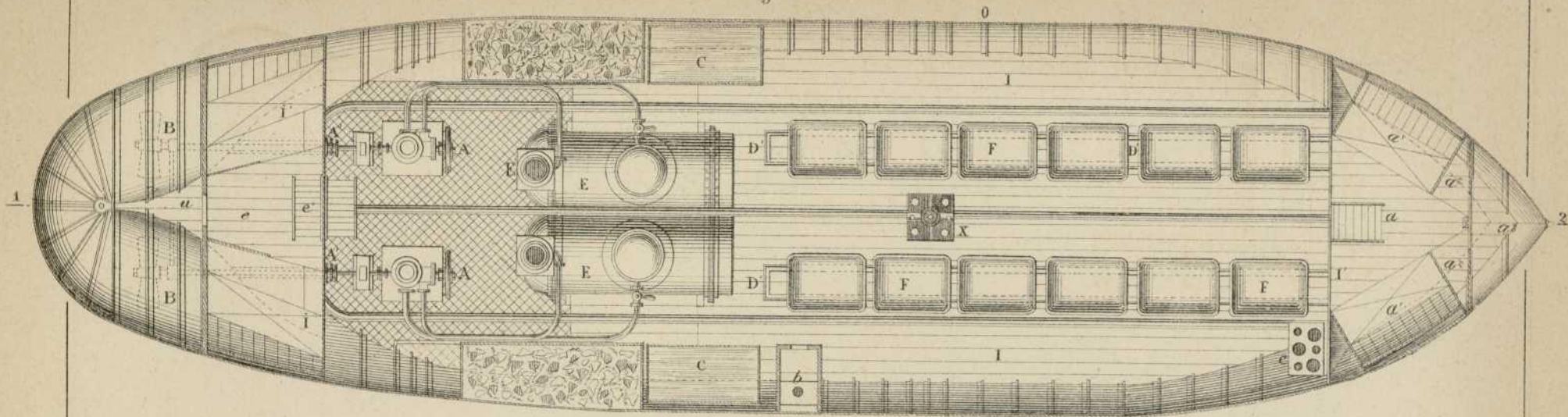
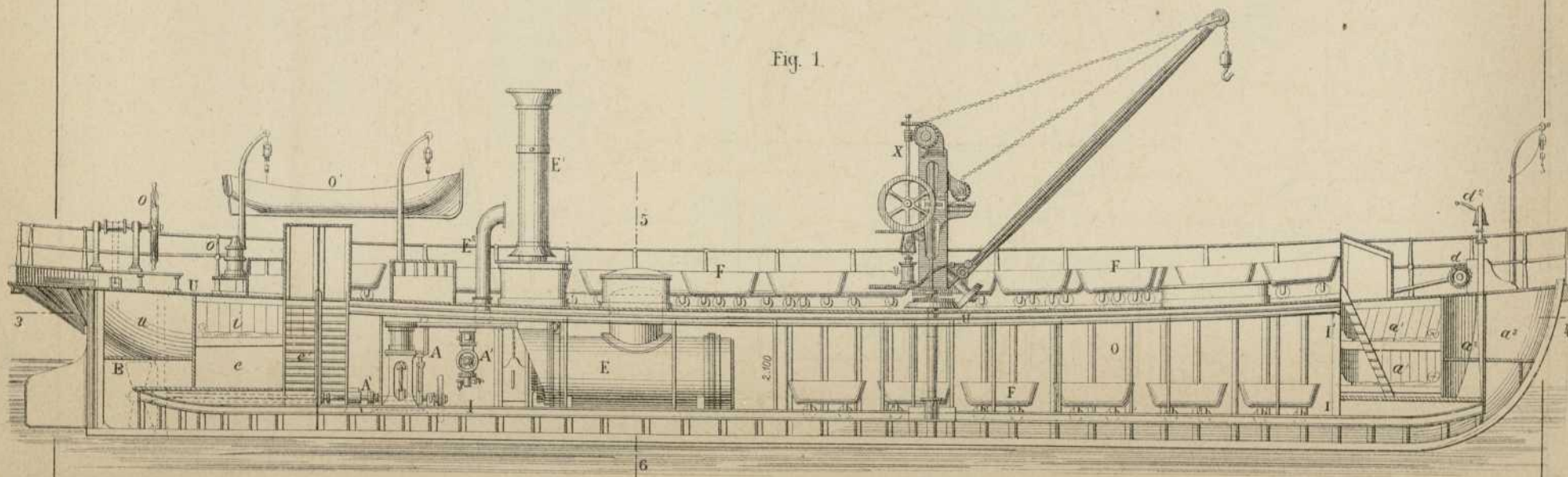
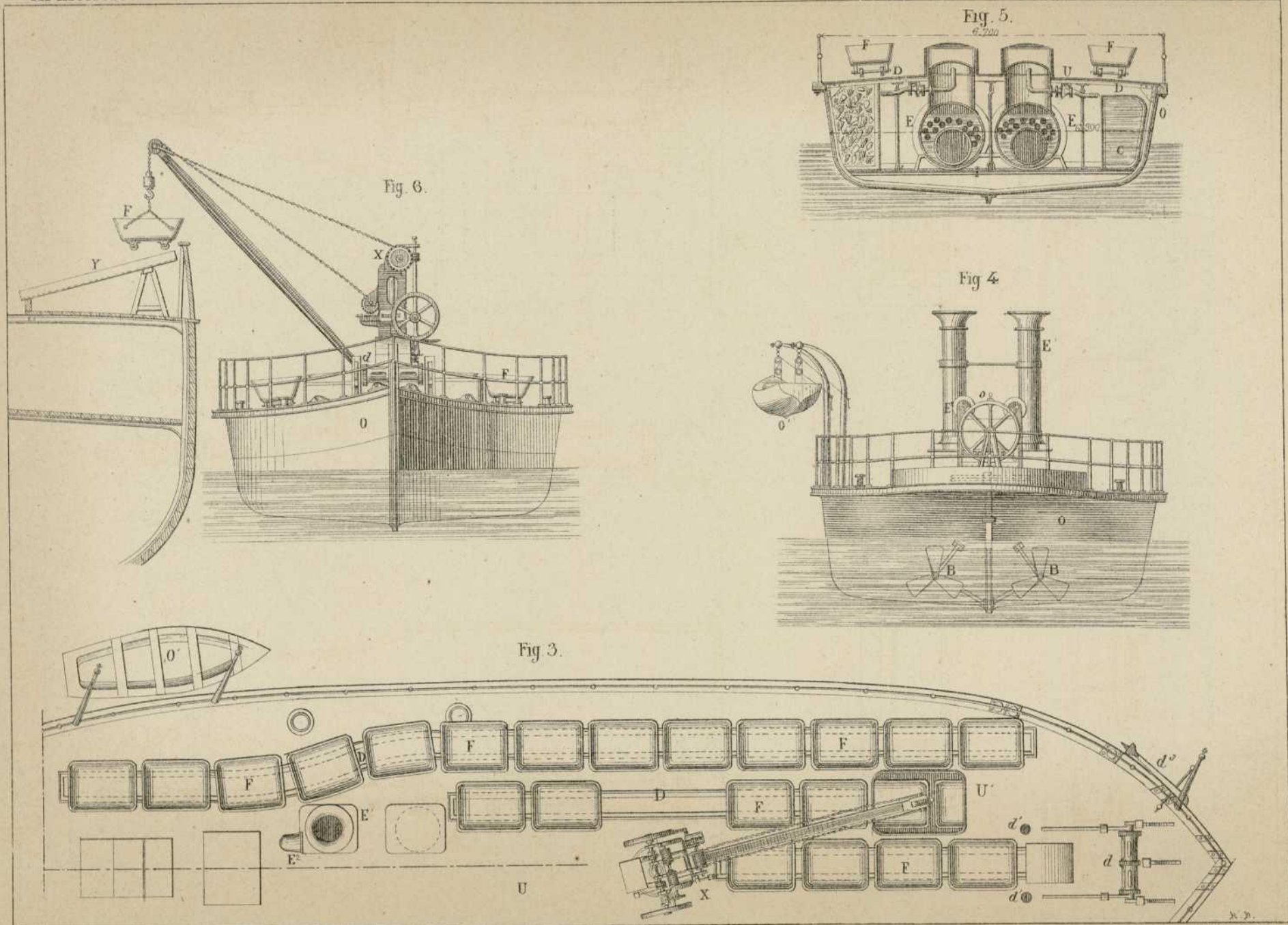
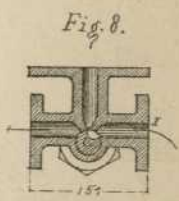
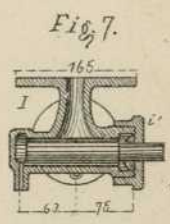
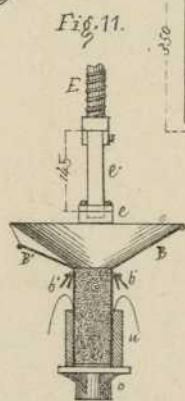
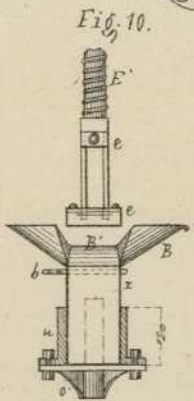
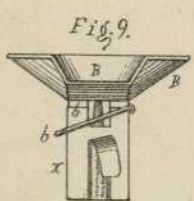
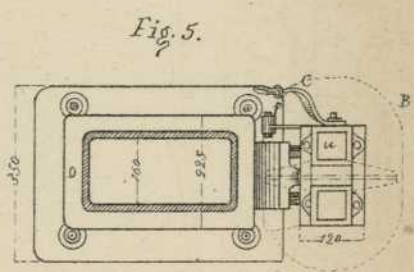
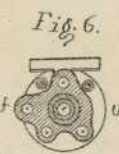
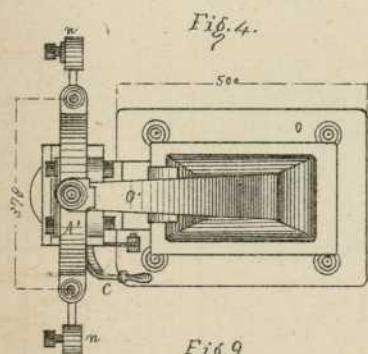
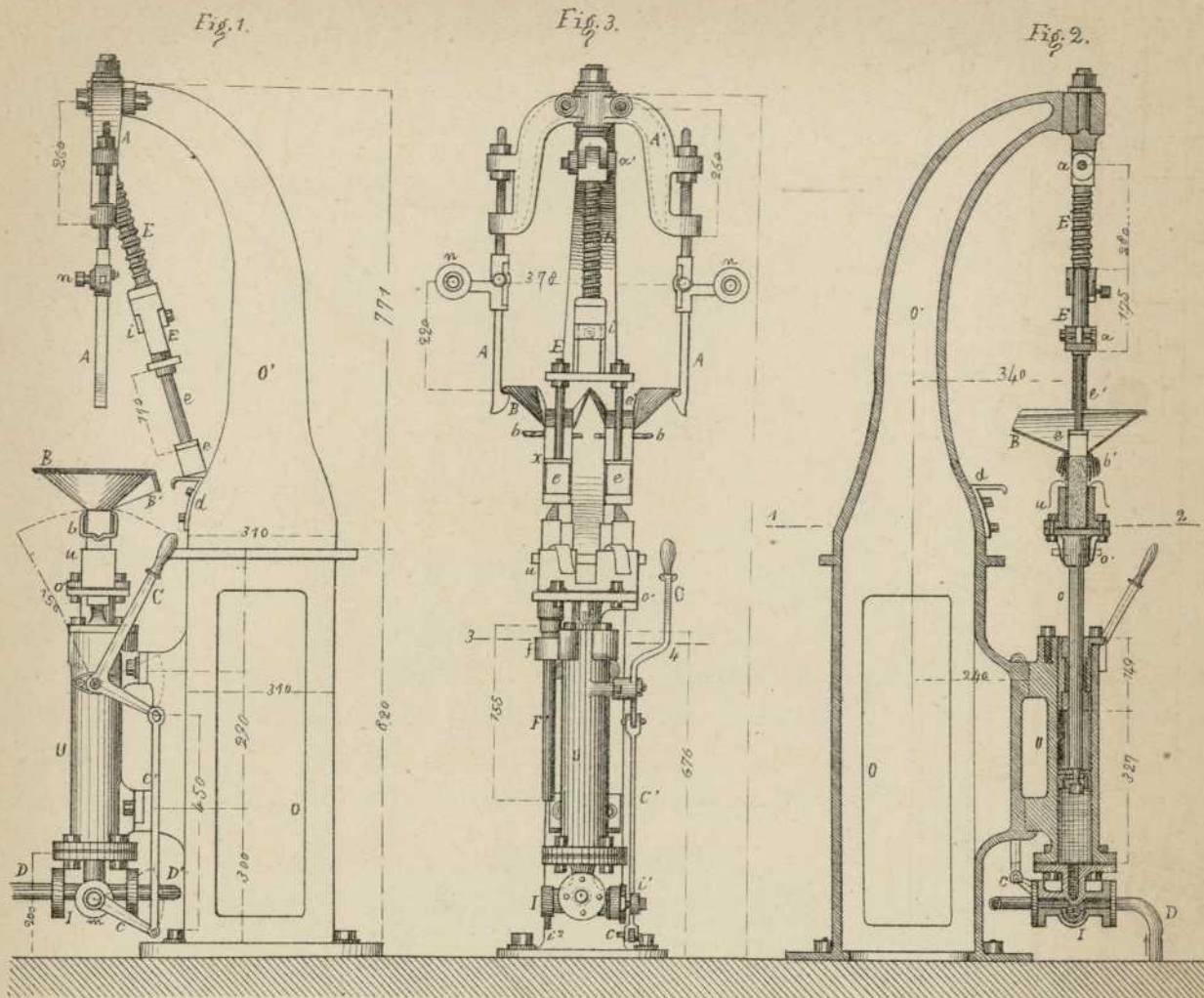


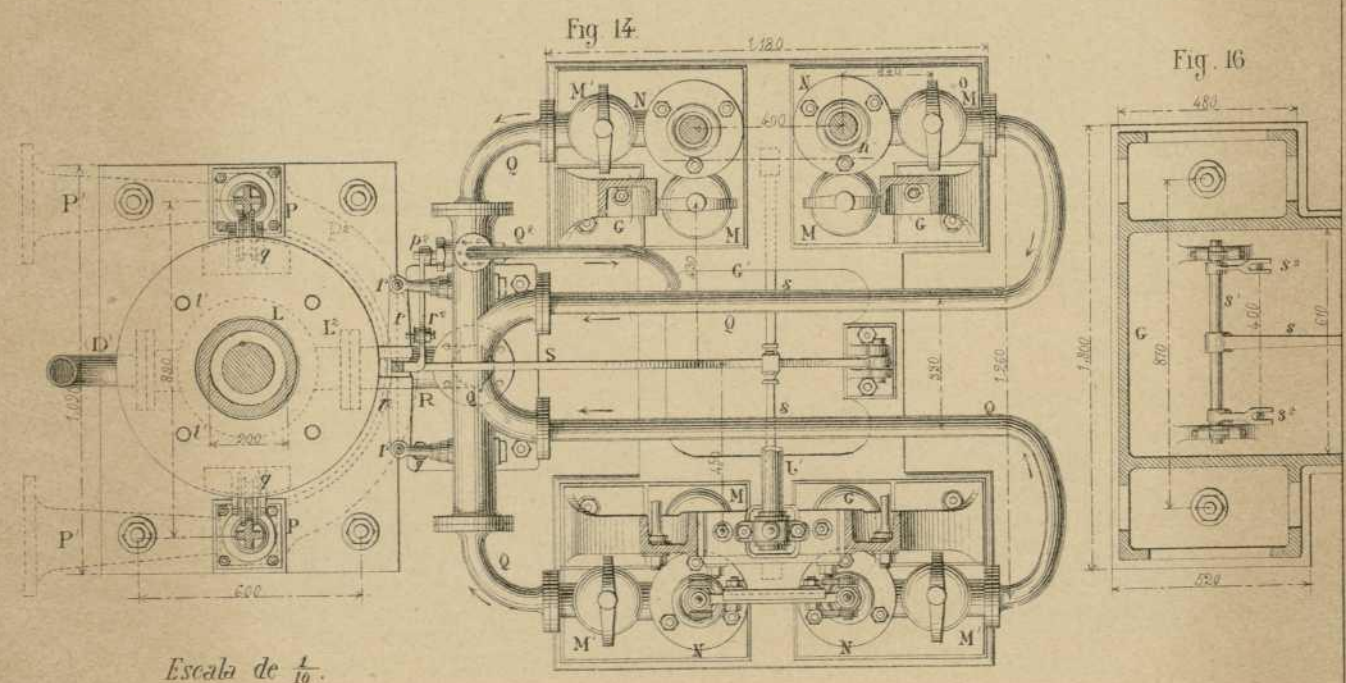
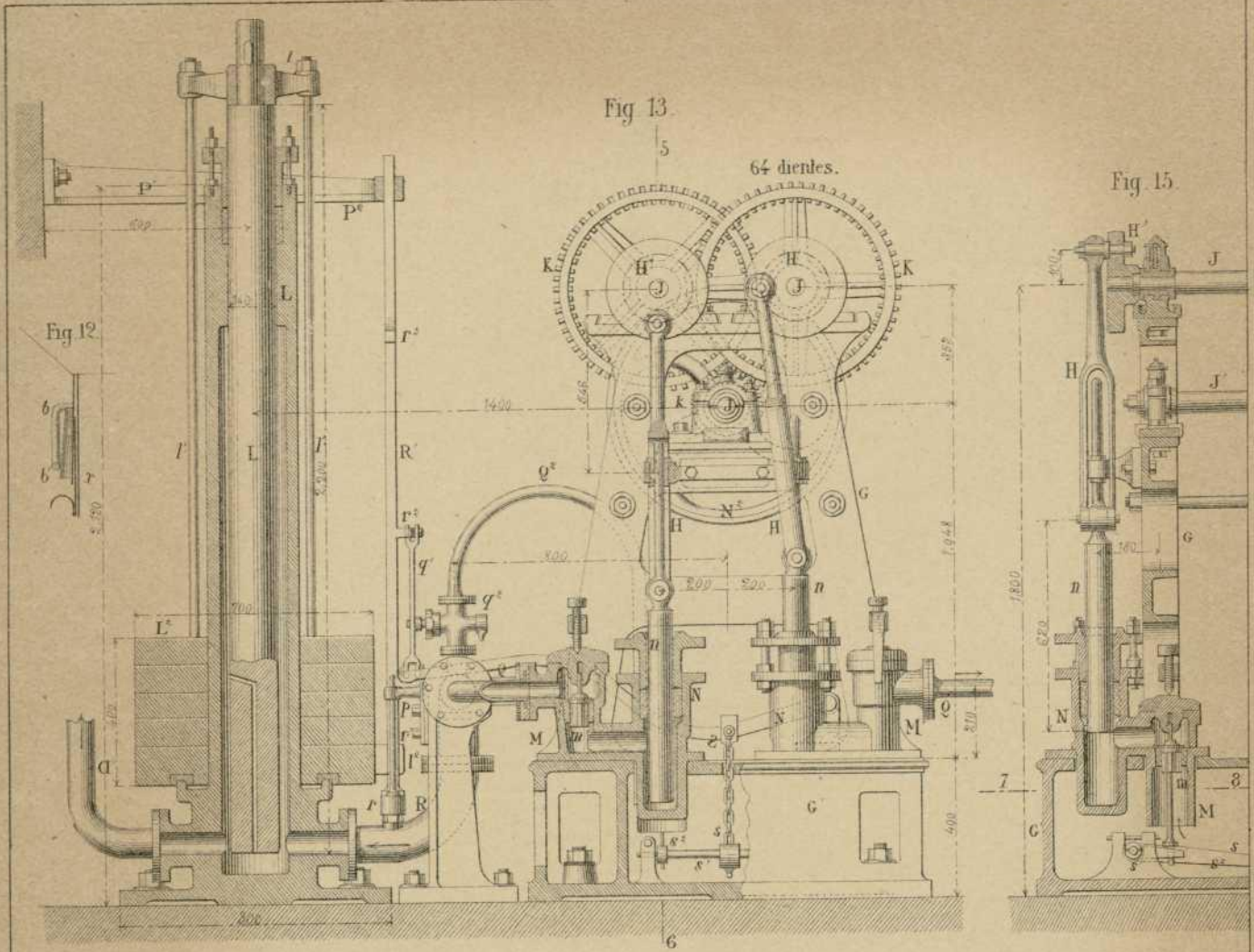
Fig. 1.







Escala de 1/16



Escala de $\frac{1}{10}$.

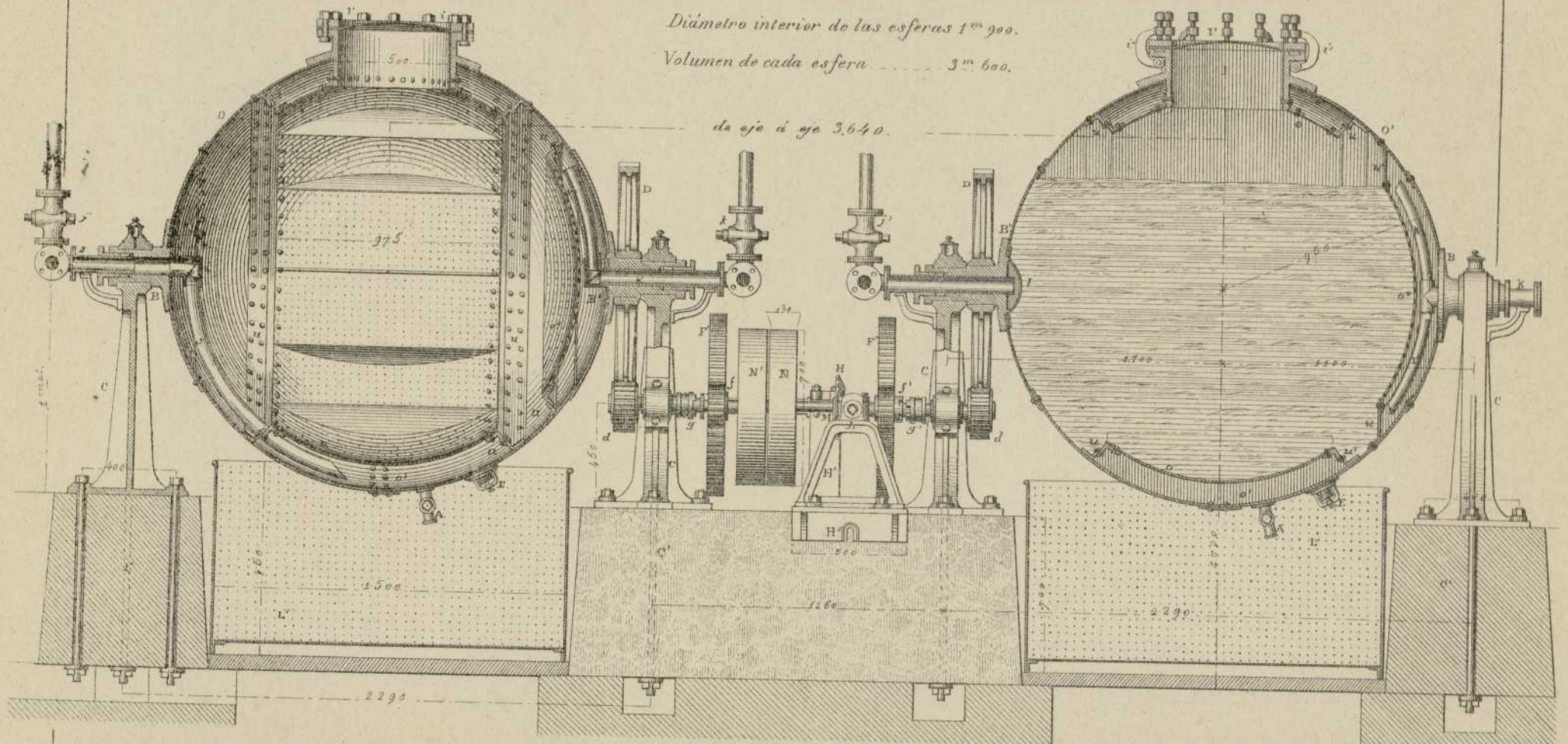
R. B.

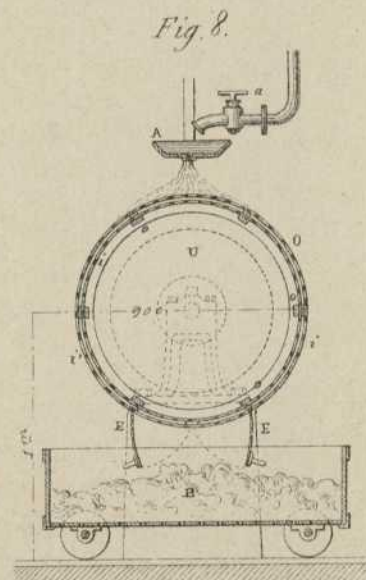
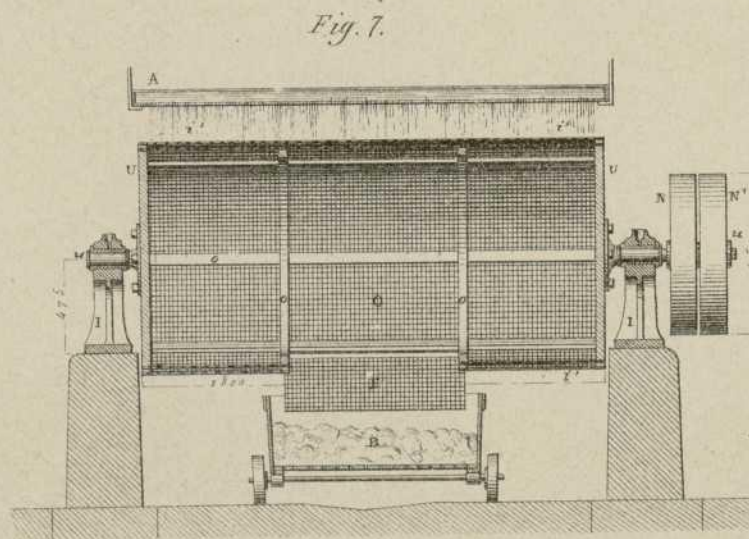
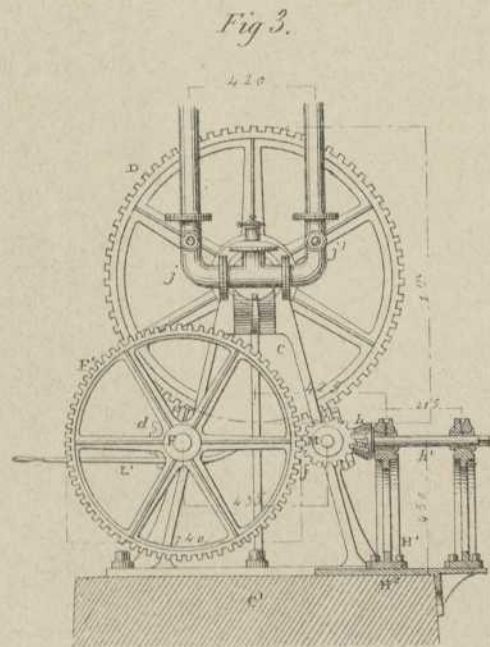
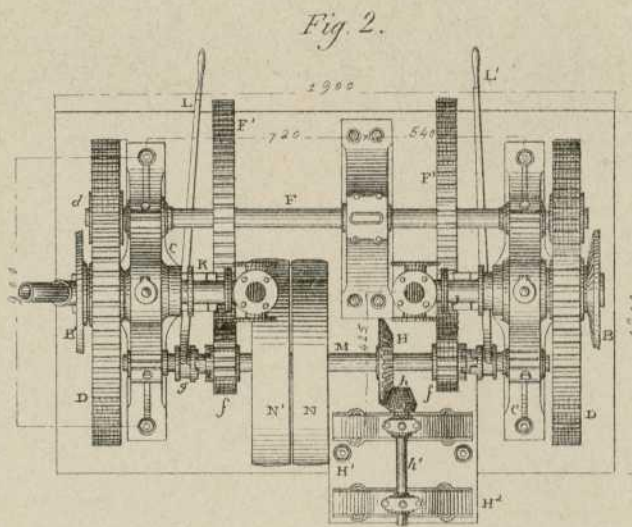
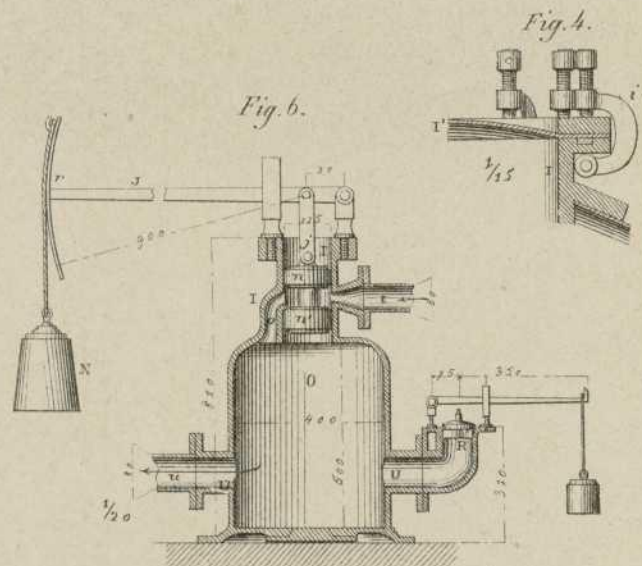
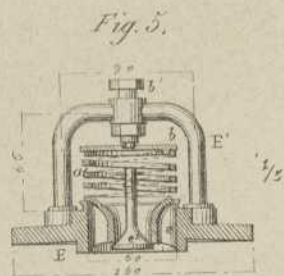
Fig. 1.

Diámetro interior de las esferas 1^{ra} 900.

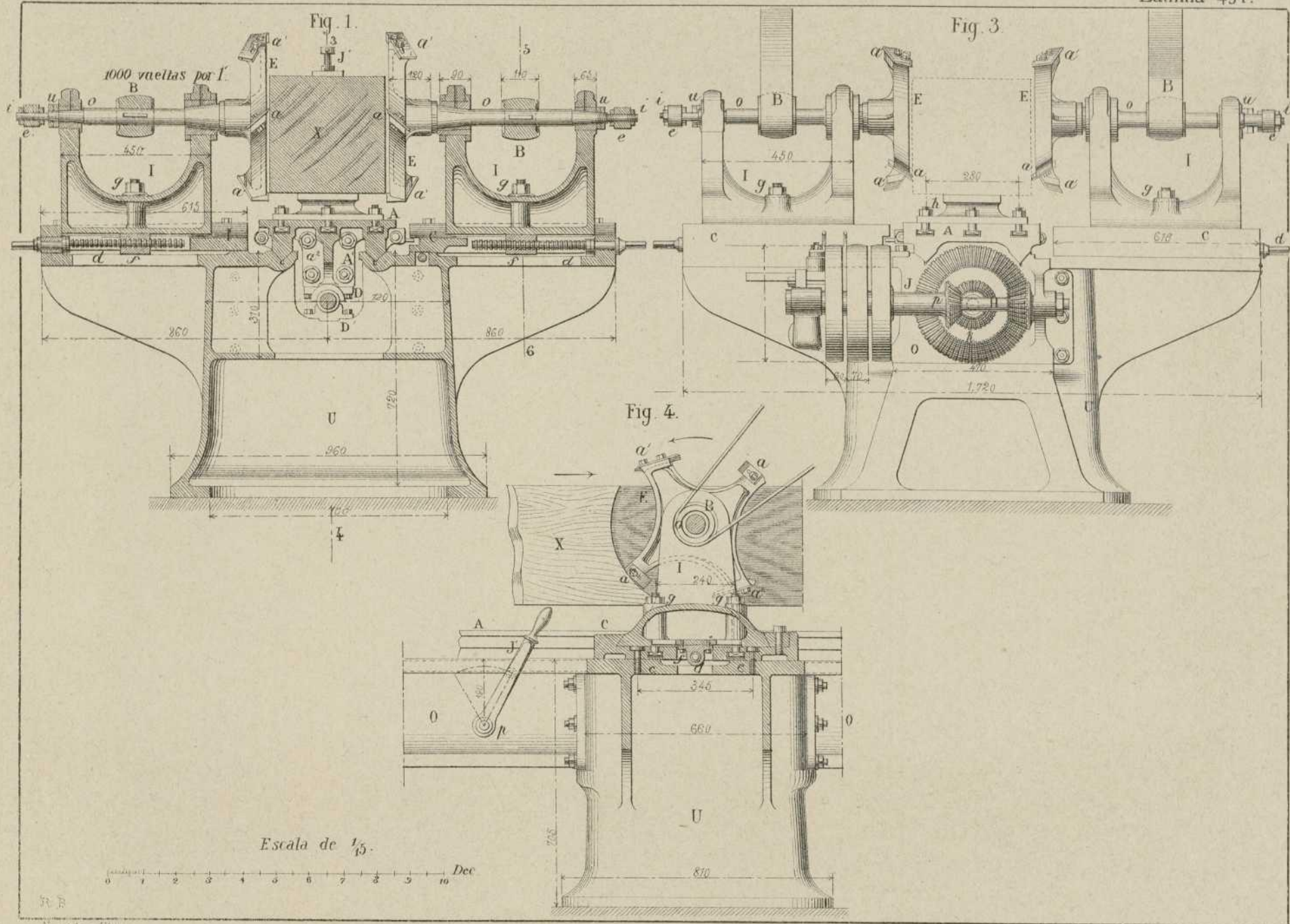
Volumen de cada esfera 3^m. 600.

de eje á eje 3,640.





Escala de 1/20 por las Fig. 1. á 3.



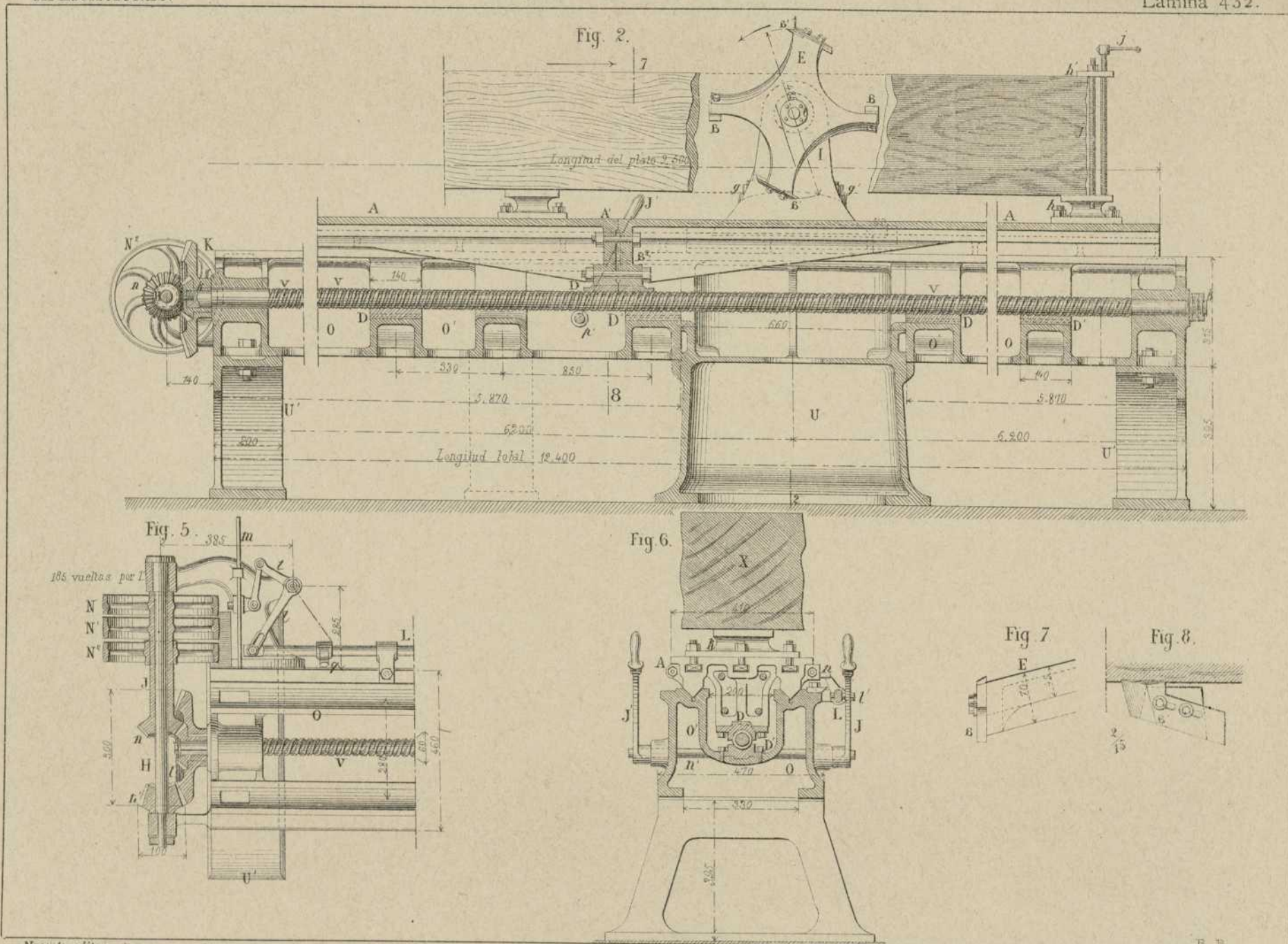


Fig. 1.

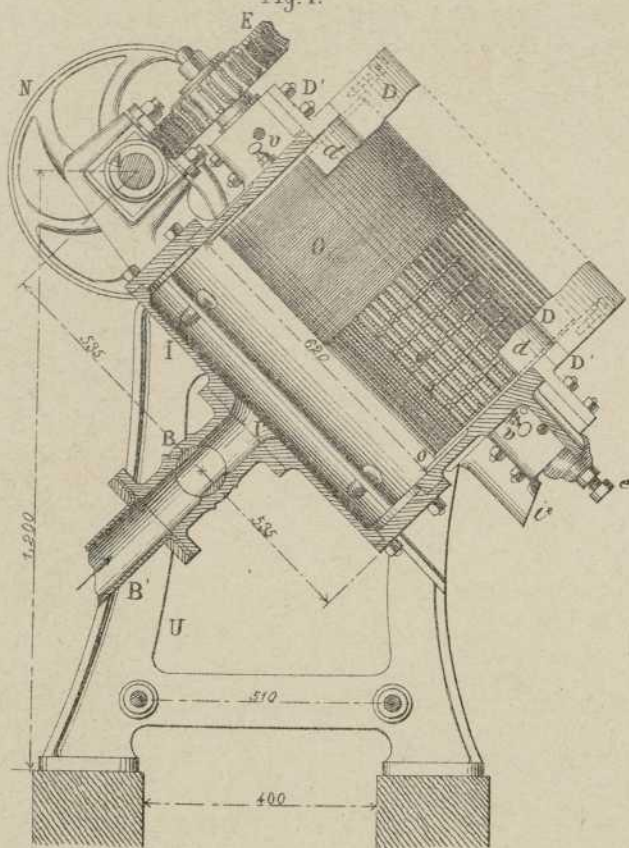


Fig. 2.

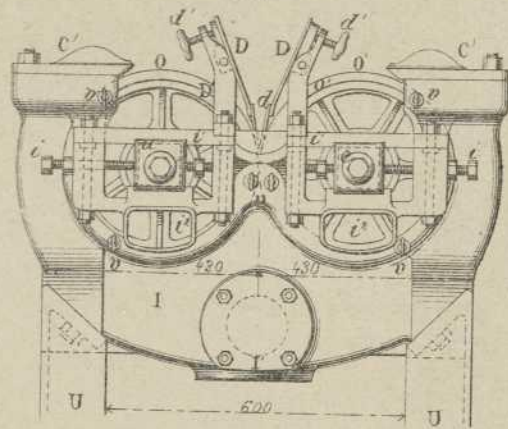


Fig. 3.

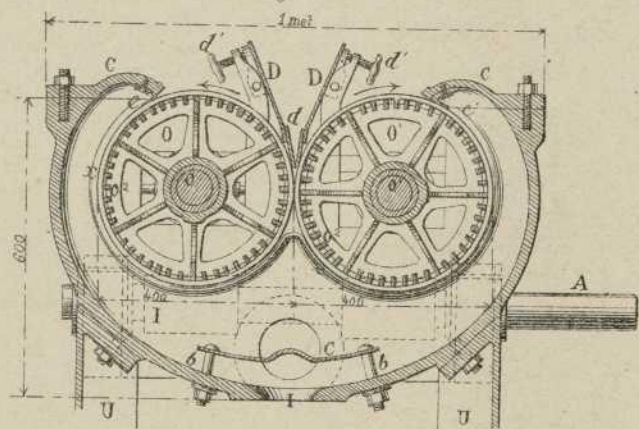


Fig. 6.

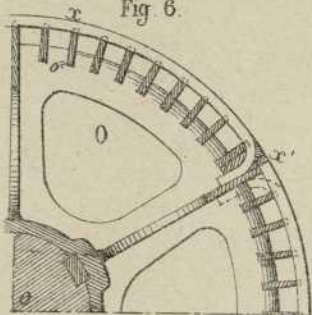


Fig. 7.

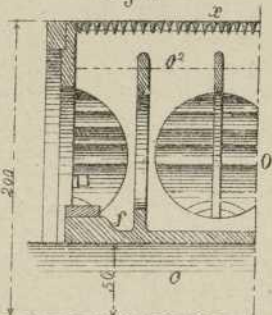


Fig. 4.

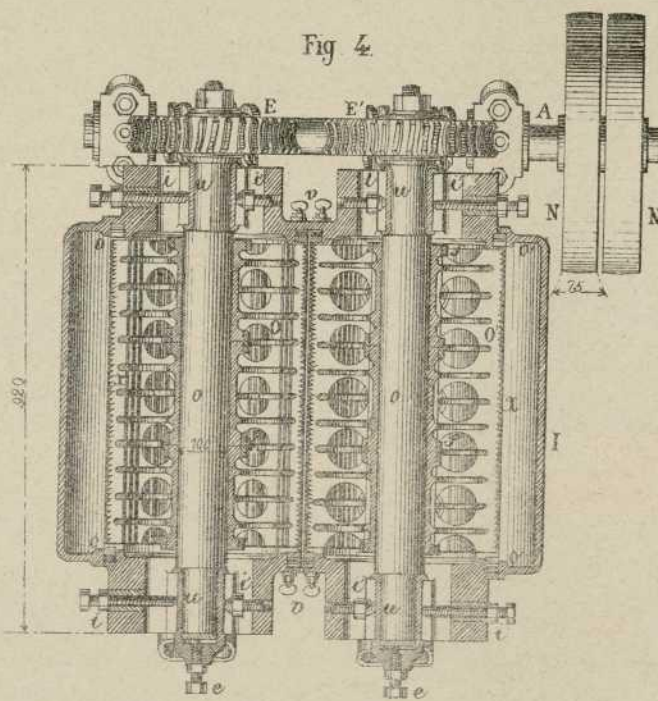


Fig. 8.

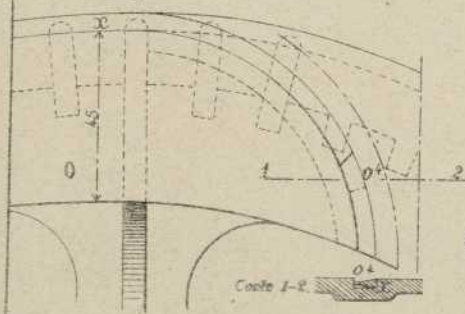
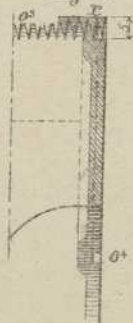


Fig. 9.



Escala de 1/3 para las Fig. 1 a 4.

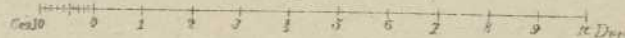


Fig. 10.

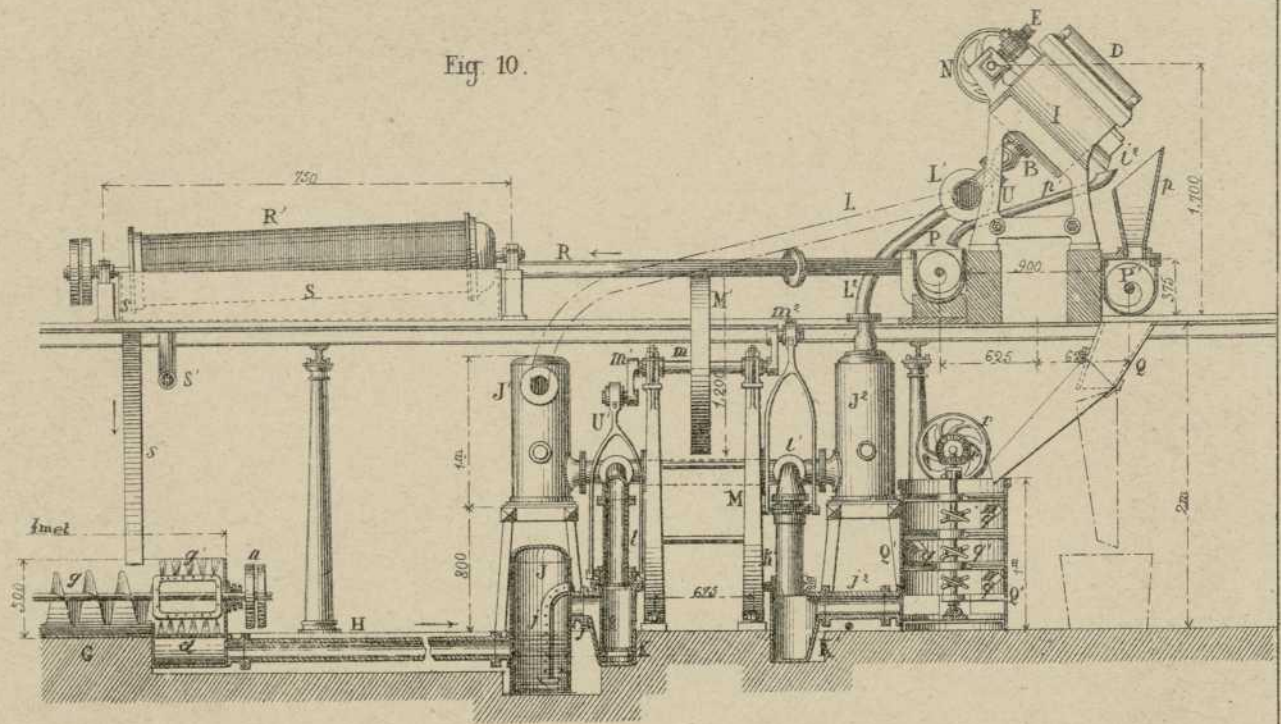


Fig. 5.

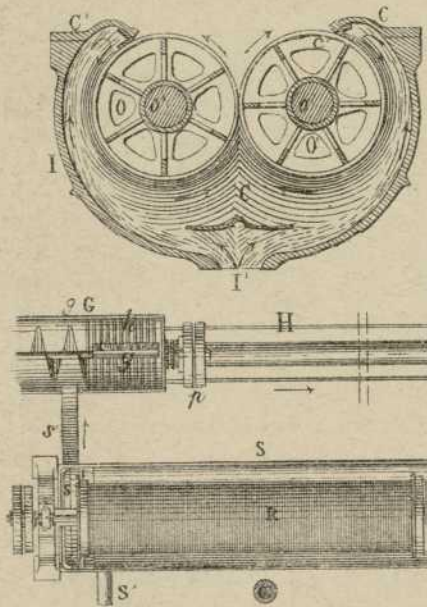
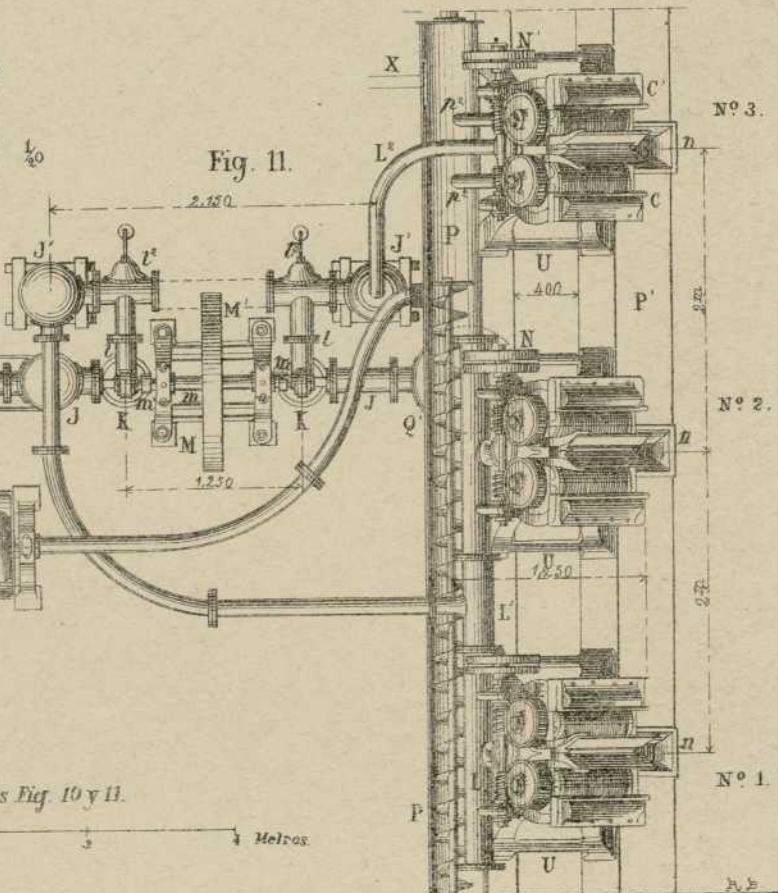


Fig. 11.



Escala de $\frac{1}{50}$ para las Fig. 10 y 11.

0 1 2 3 4 5 6 7 8 9 10 Metros

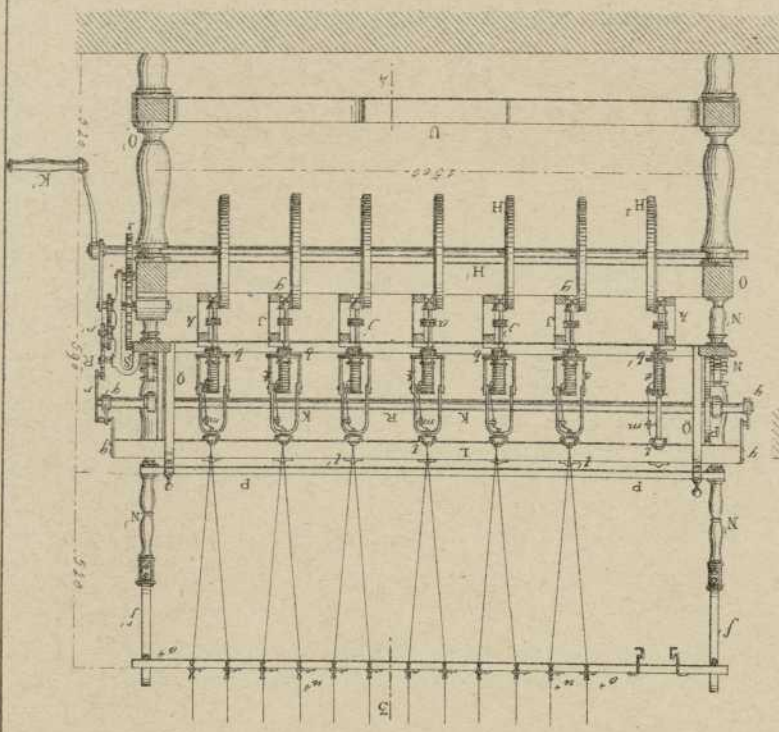


Fig. 4.

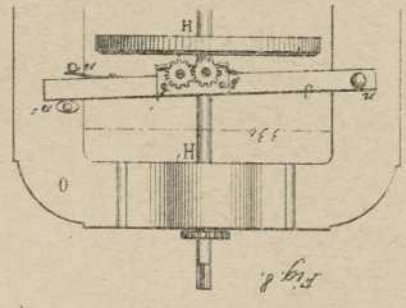


Fig. 8.

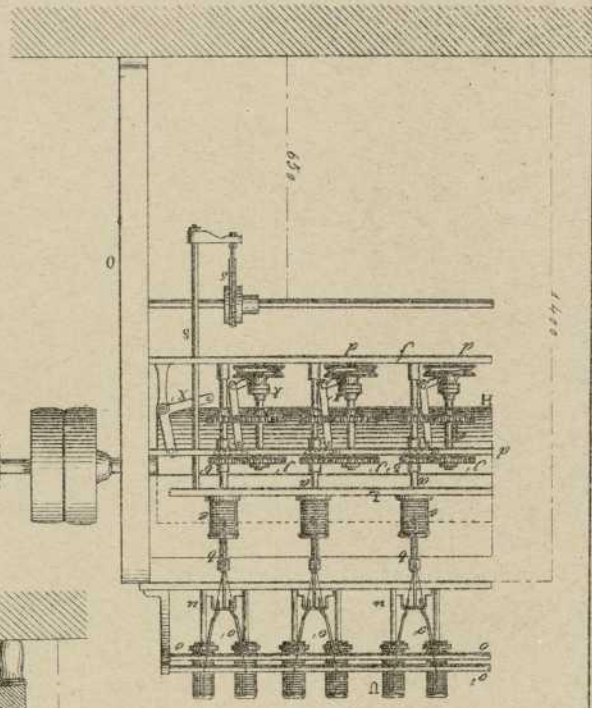


Fig. 15.

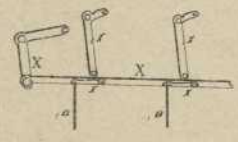


Fig. 16.

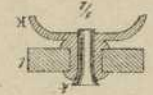


Fig. 17.

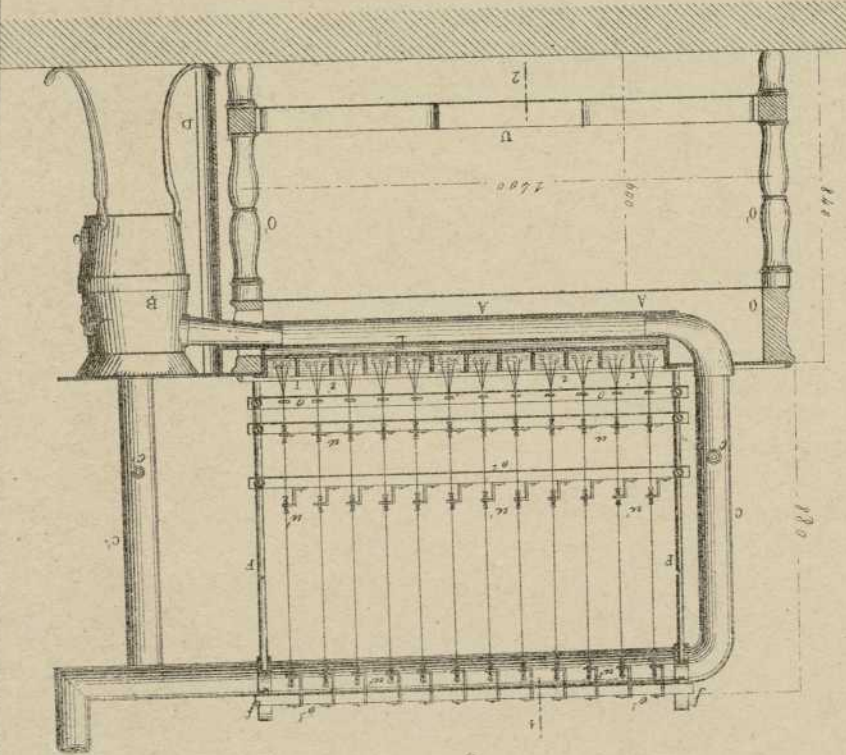


Fig. 1.

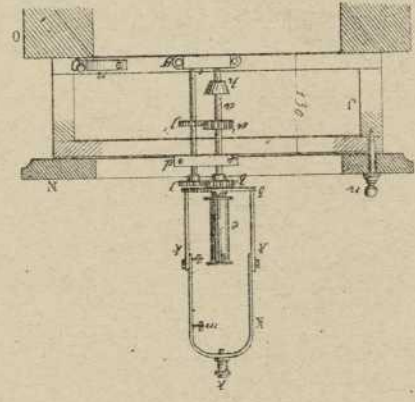
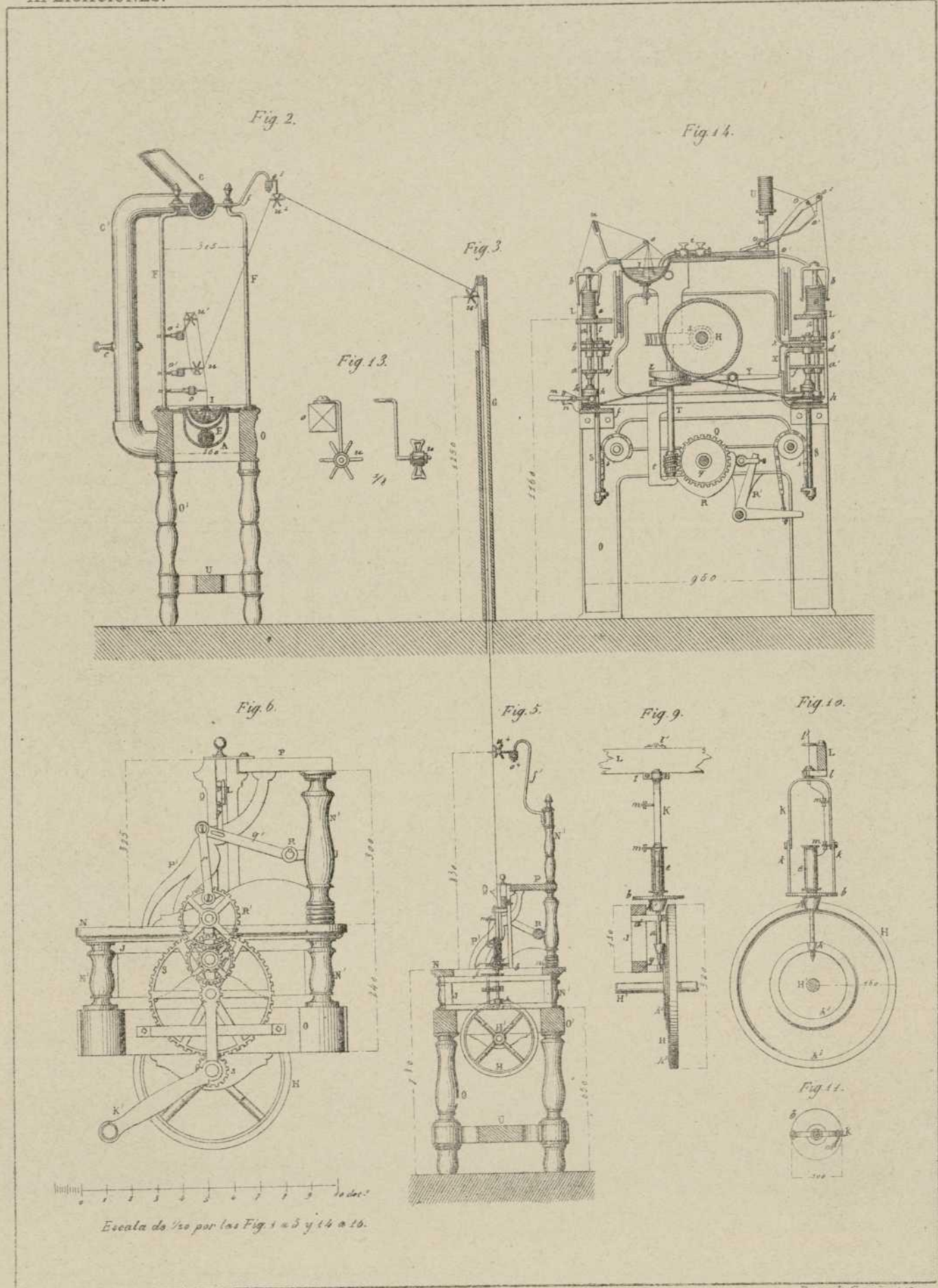


Fig. 7.



Escala de 1/20 por las Fig. 1 a 5 y 14 a 16.

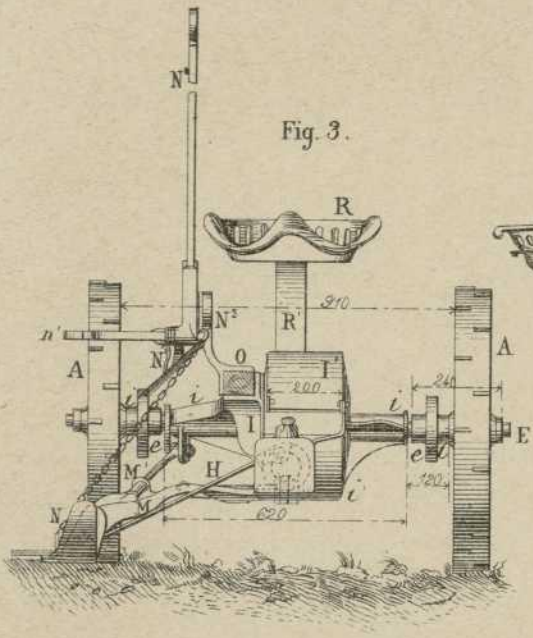


Fig. 3.

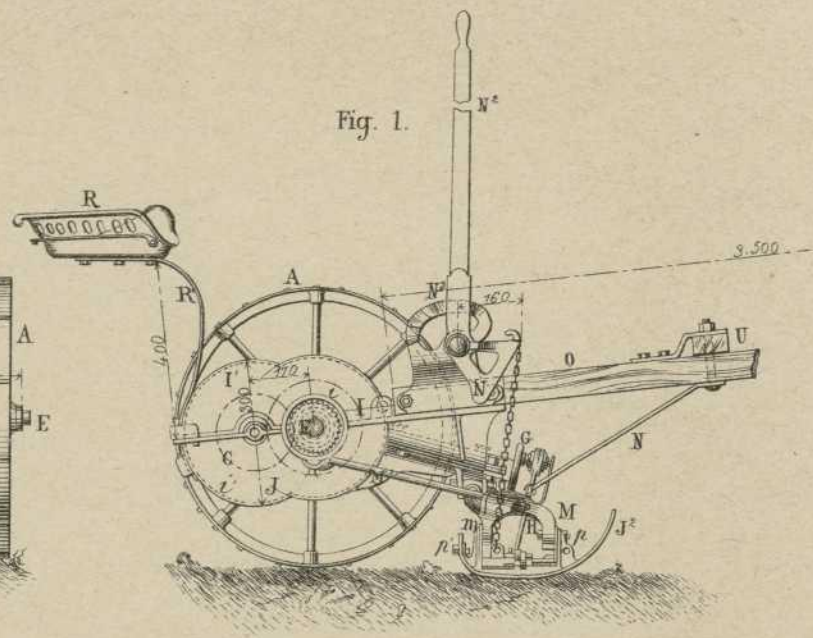


Fig. 1.

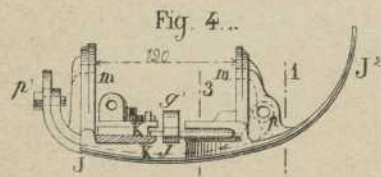


Fig. 4.

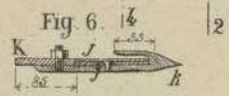


Fig. 6.

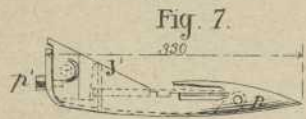


Fig. 7.

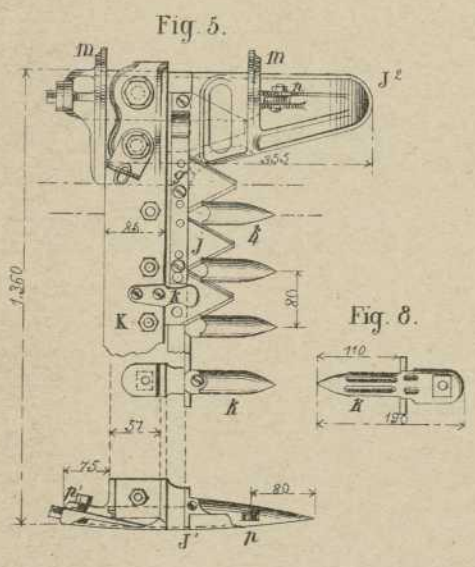


Fig. 5.

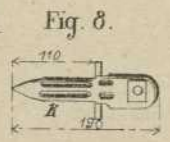


Fig. 8.

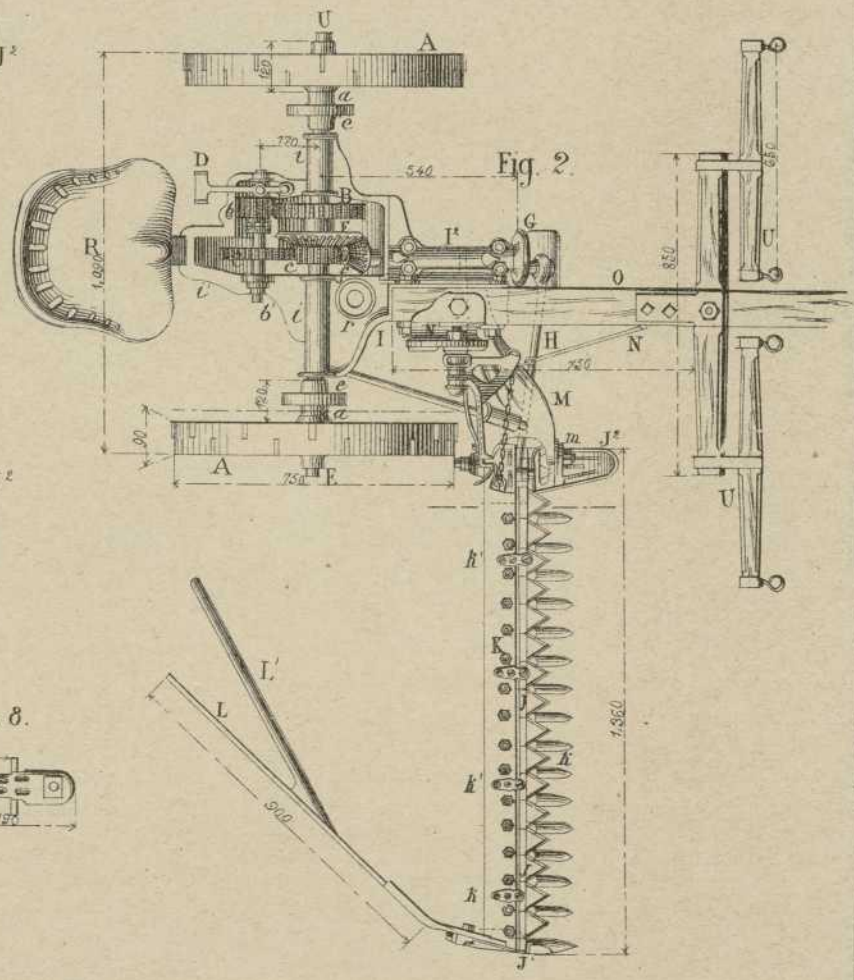
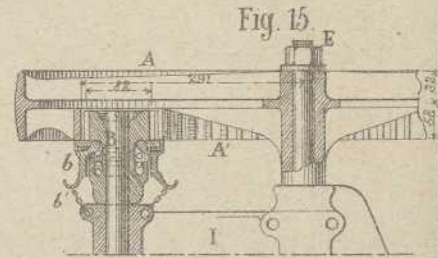
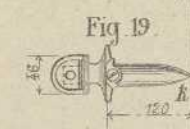
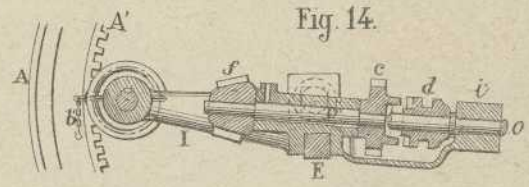
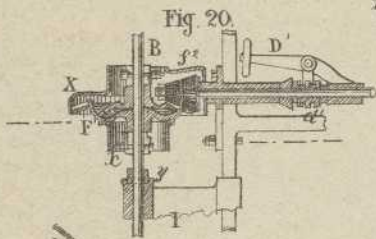
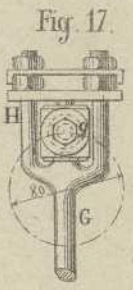
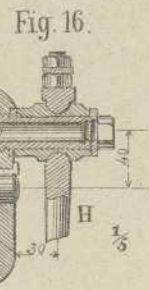
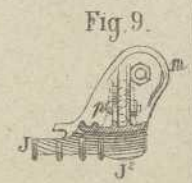
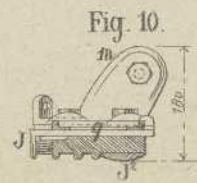
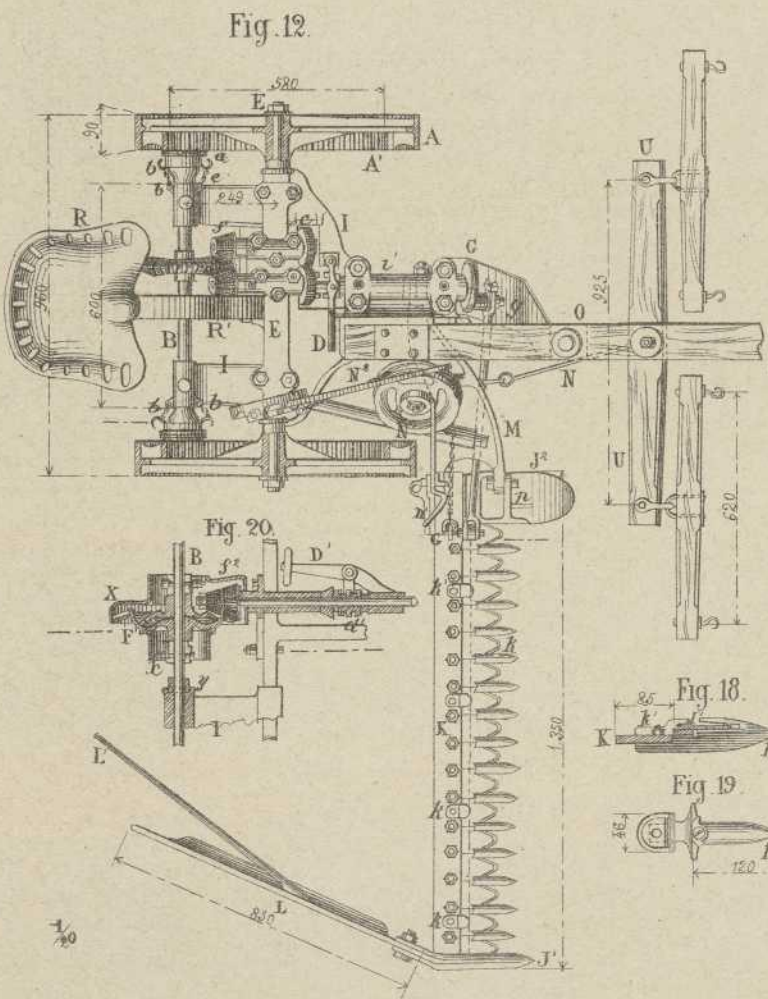
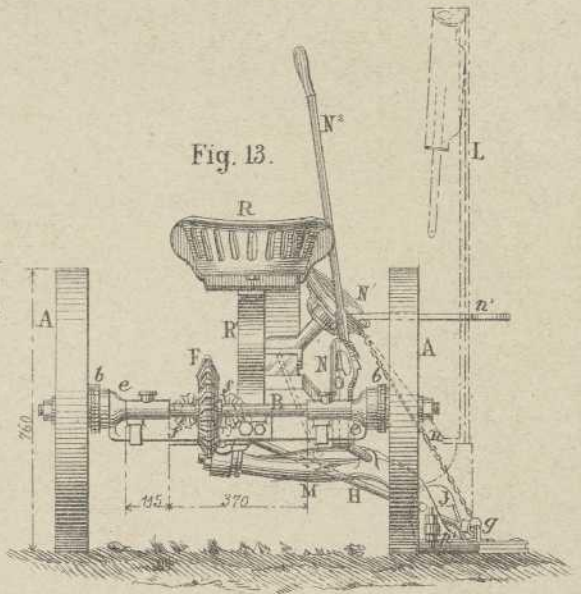
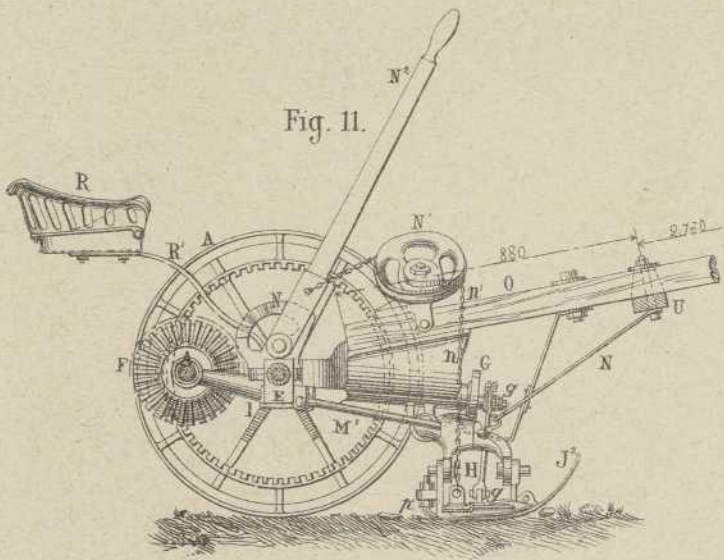


Fig. 2.

Escala de 1/20 para las Fig. 1 a 3 y 11. 13.



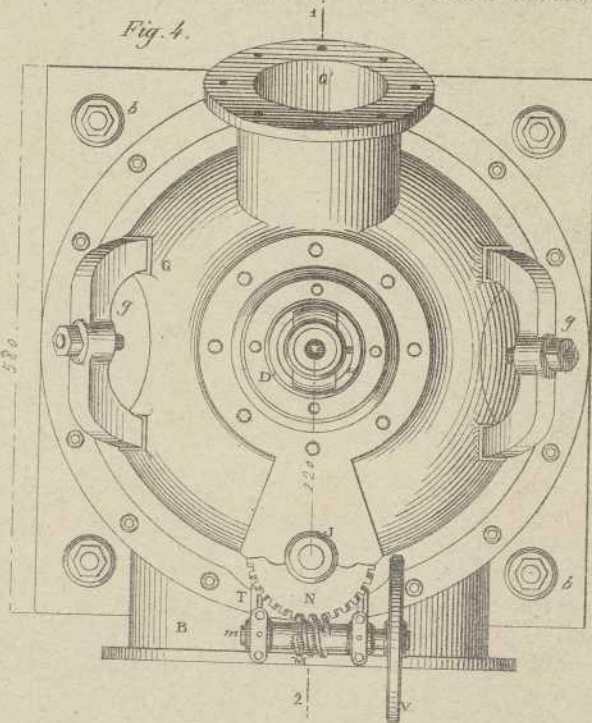
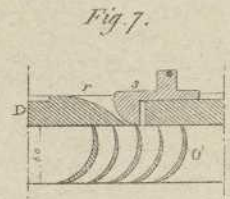
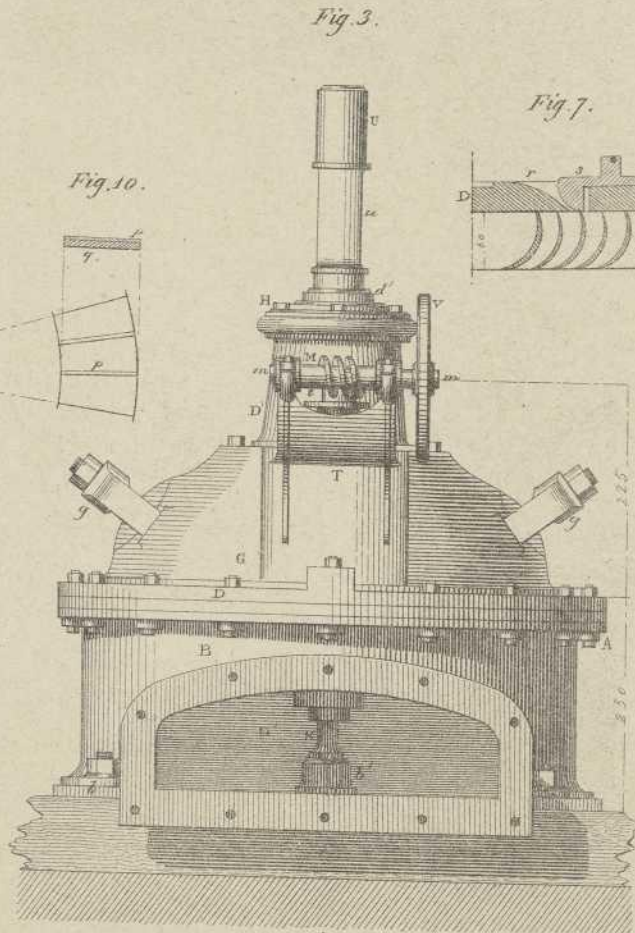
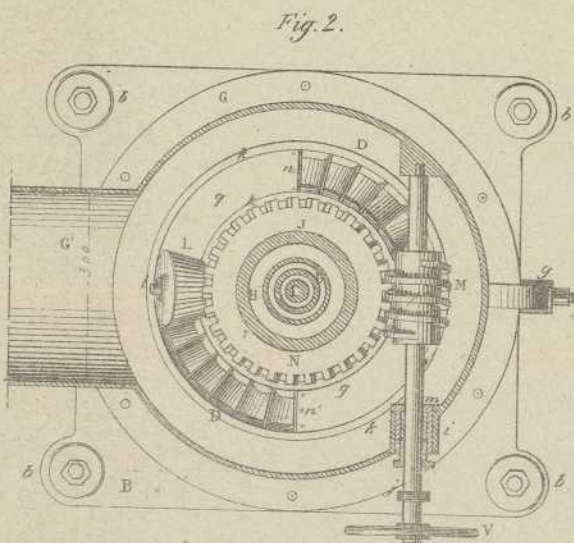
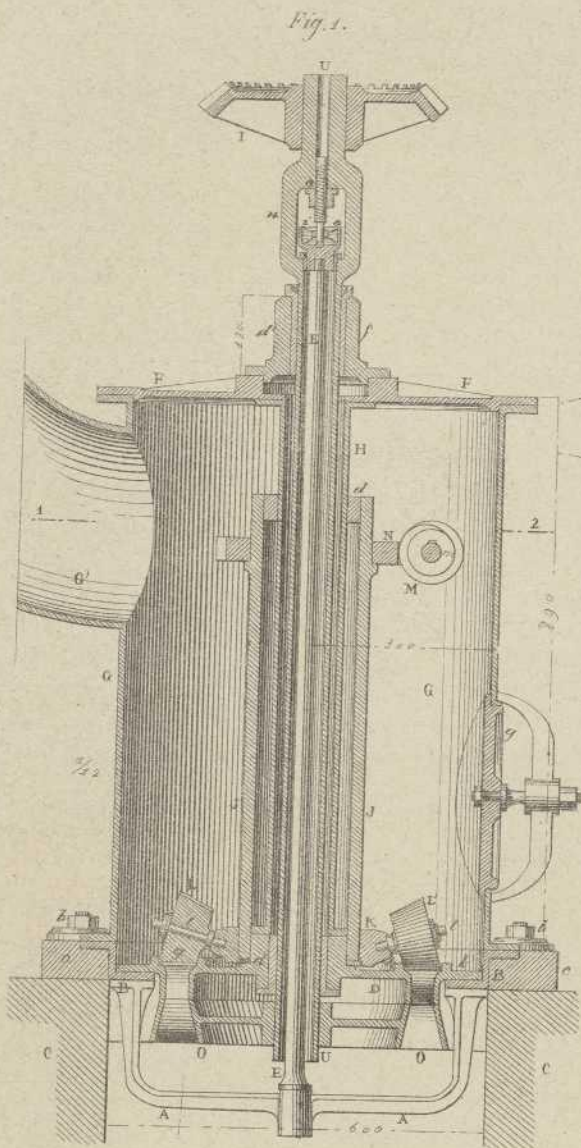


Fig. 5.

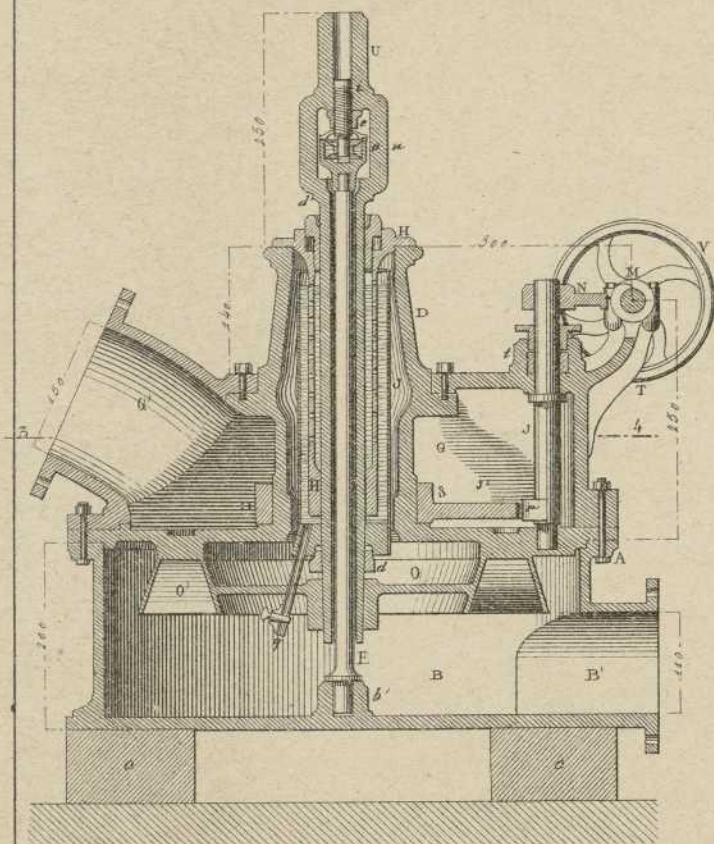


Fig. 6.

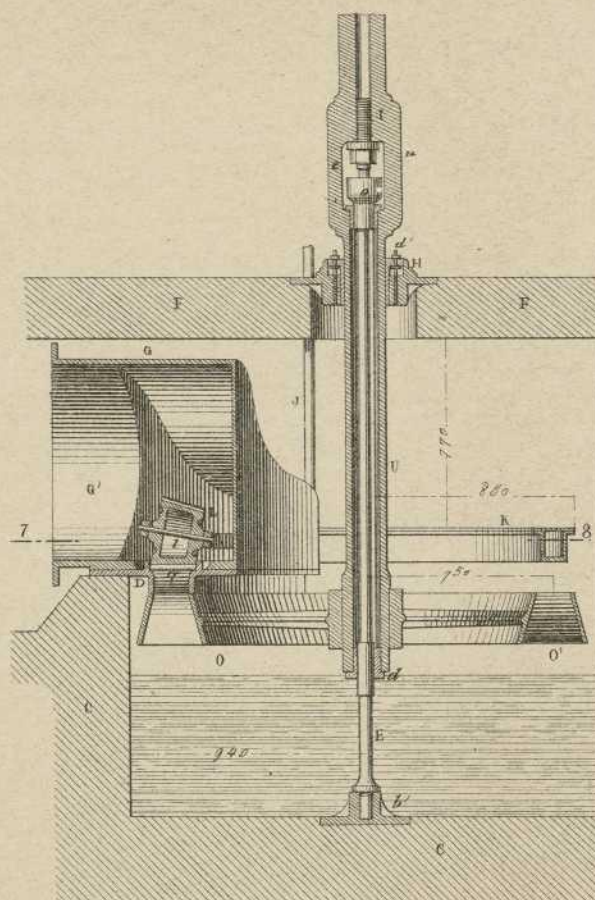


Fig. 6.

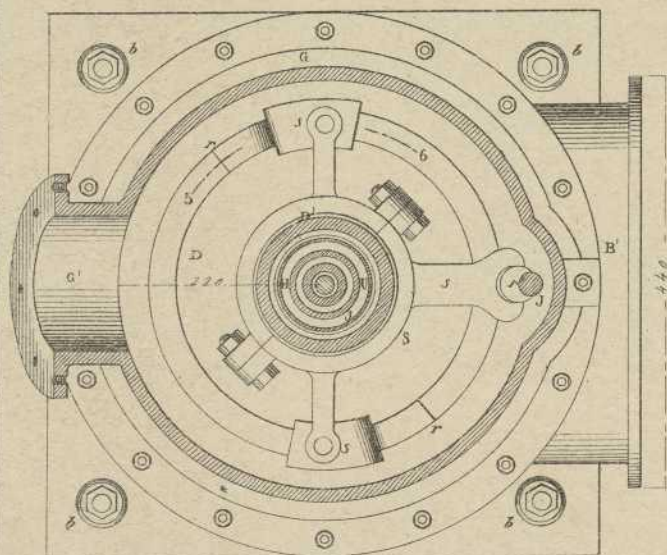


Fig. 11.

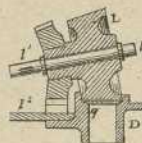
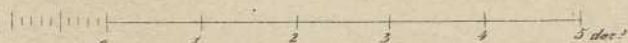
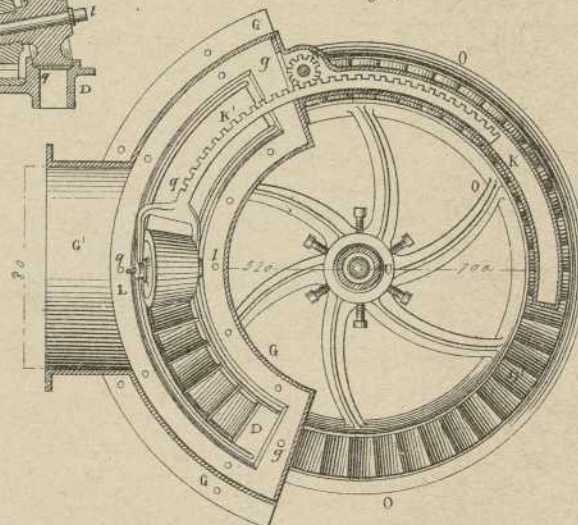


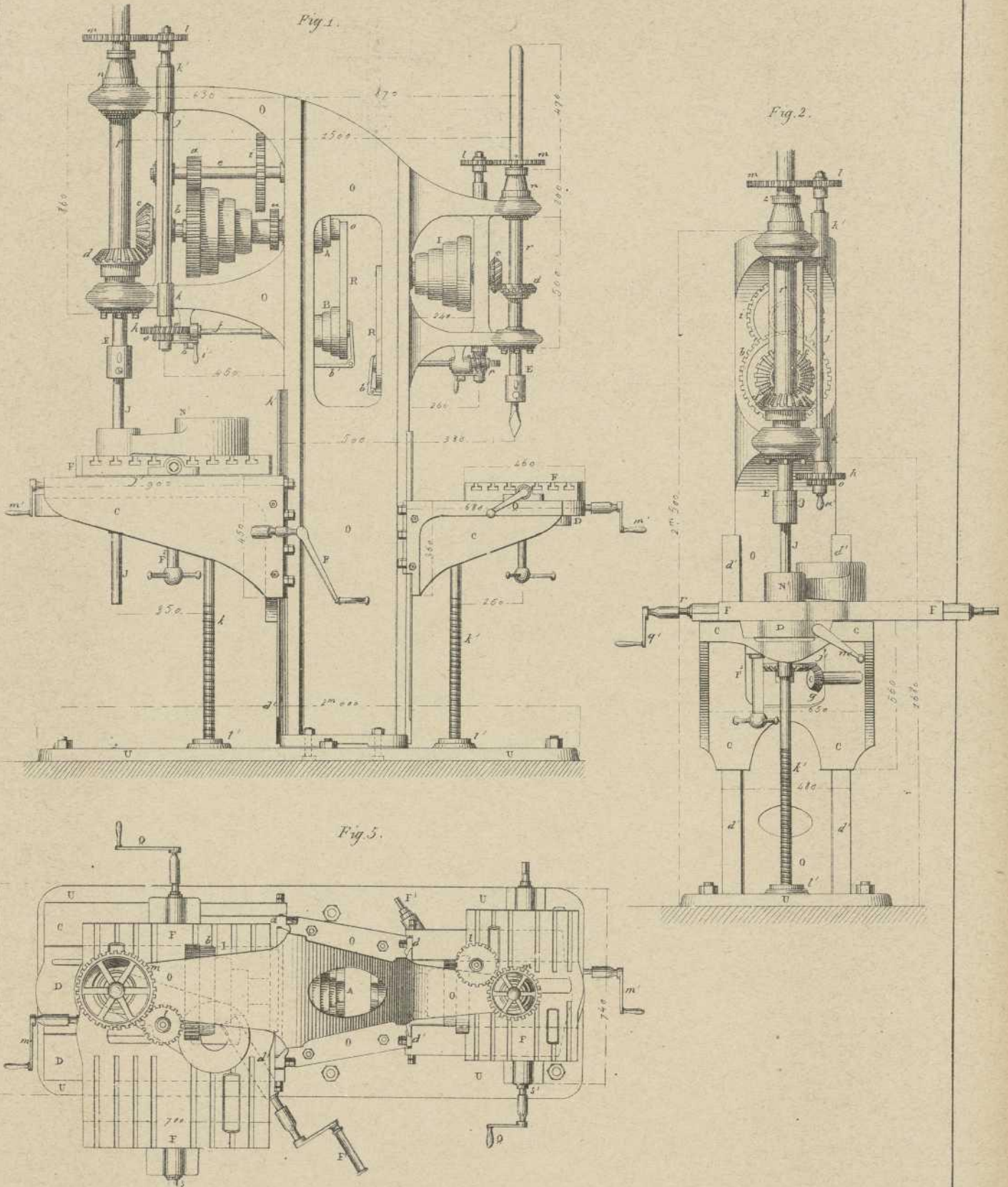
Fig. 9.

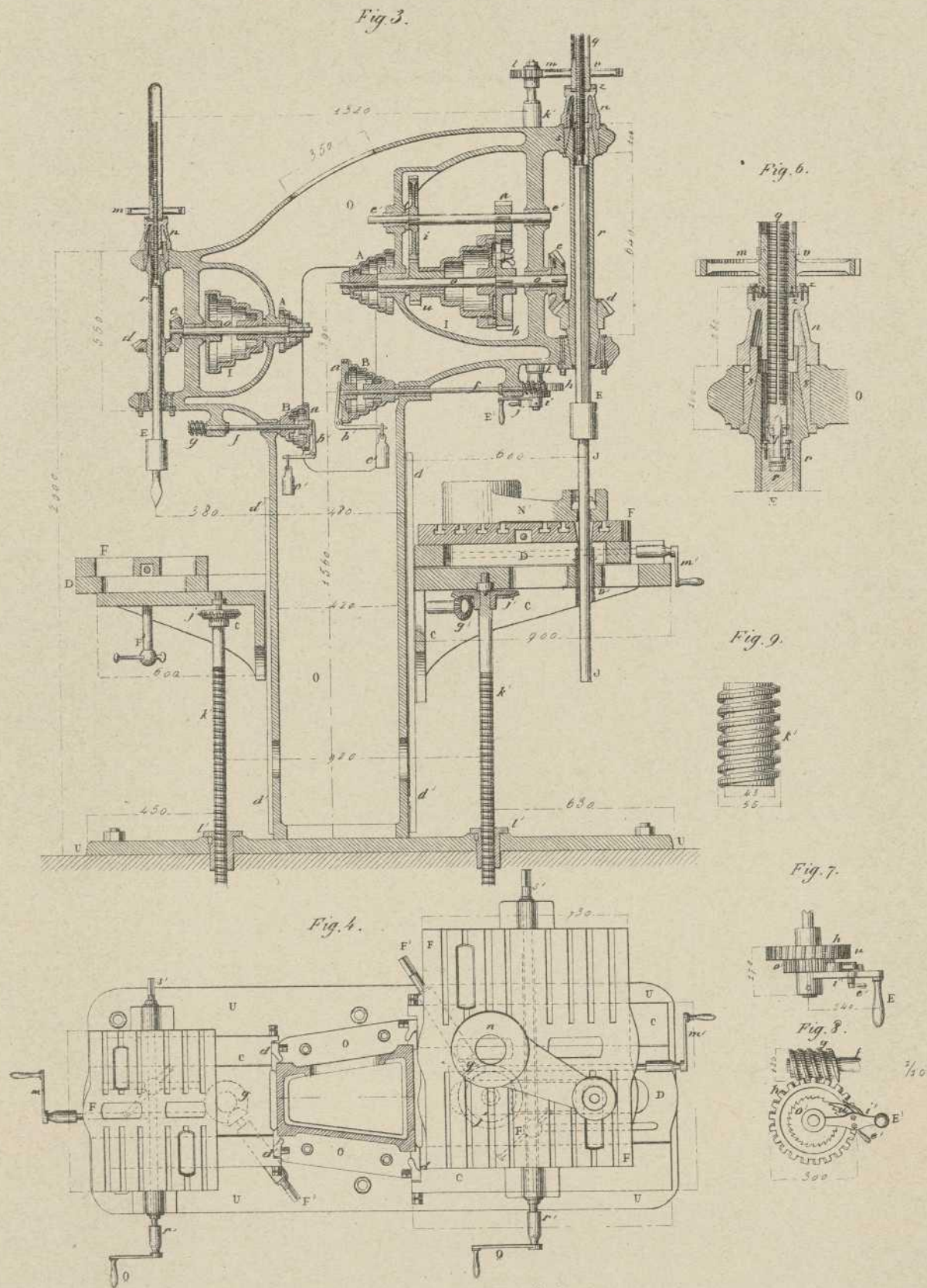


Escala de $\frac{1}{4}$ por las Fig. 3 a 7.

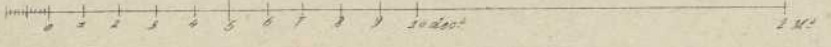


Escala de $\frac{1}{50}$ por las Fig. 8 y 9.



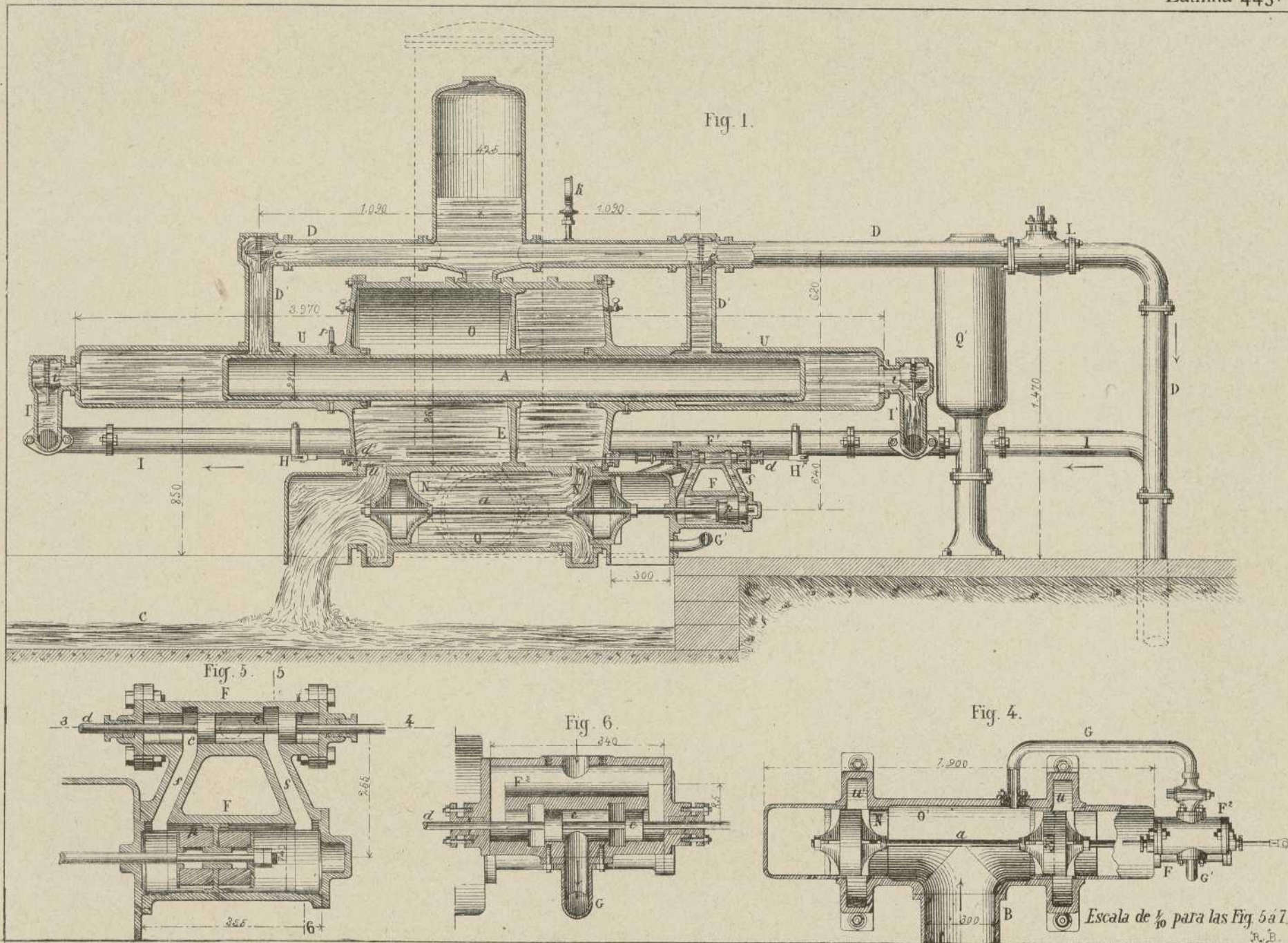


Escala de 1/50 por las Fig. 1. a 5.

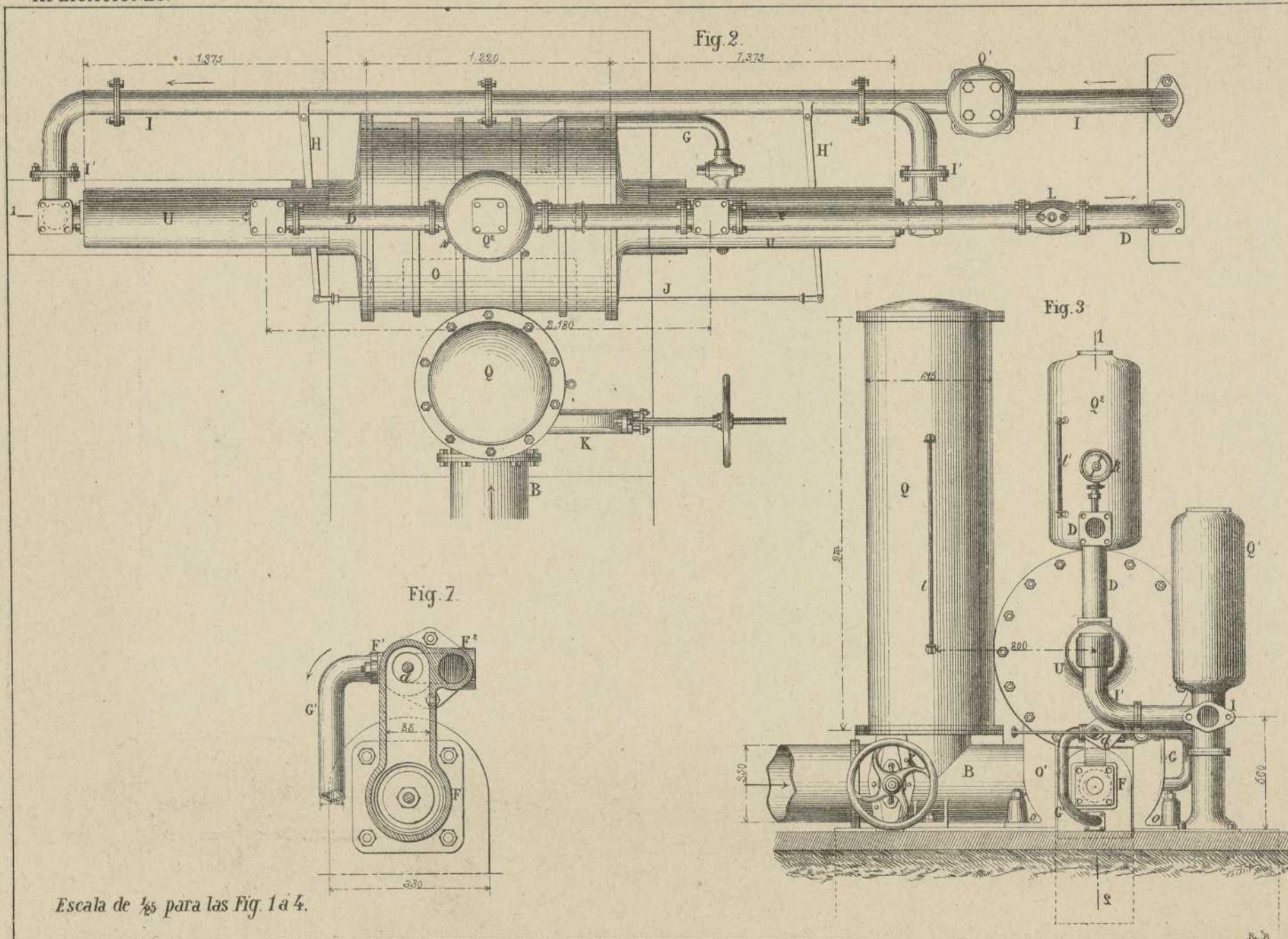


Nacente, editor.

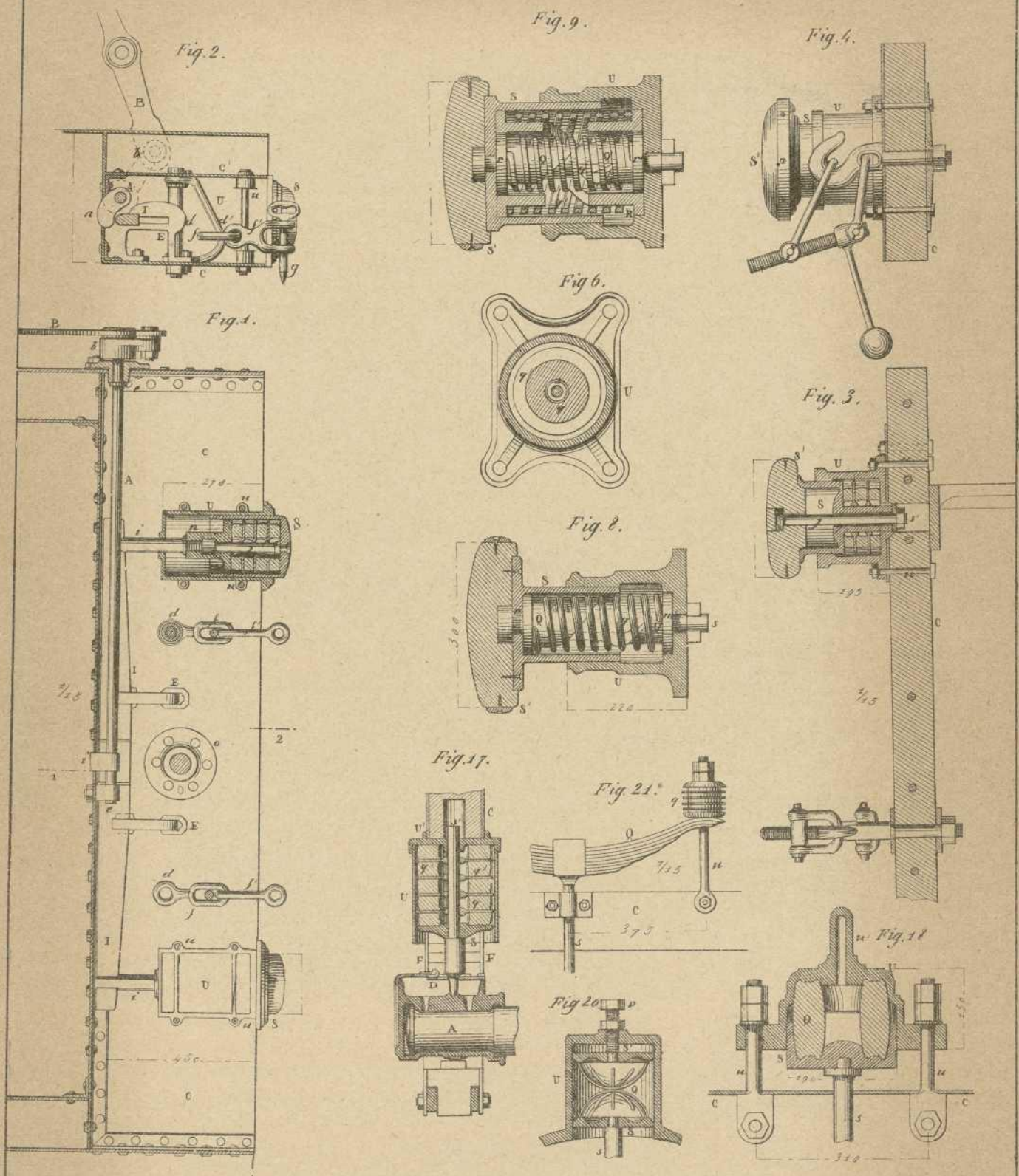
Paseo de Gracia, 149.

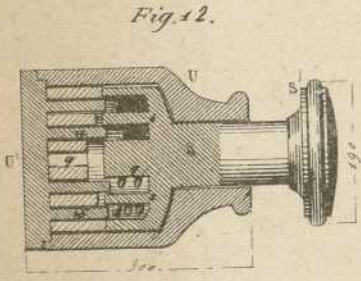
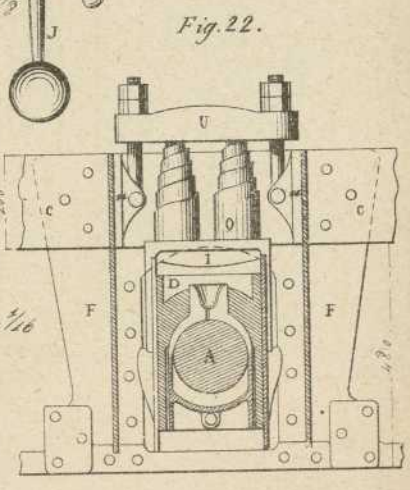
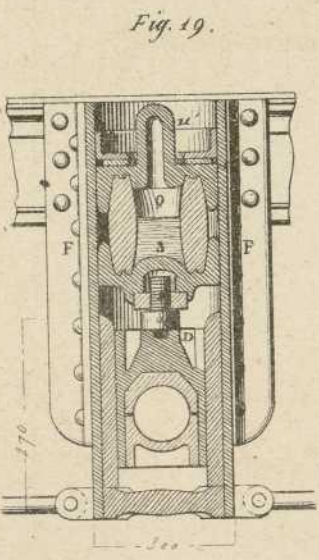
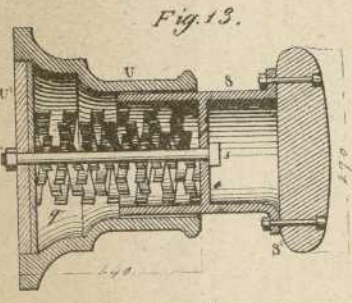
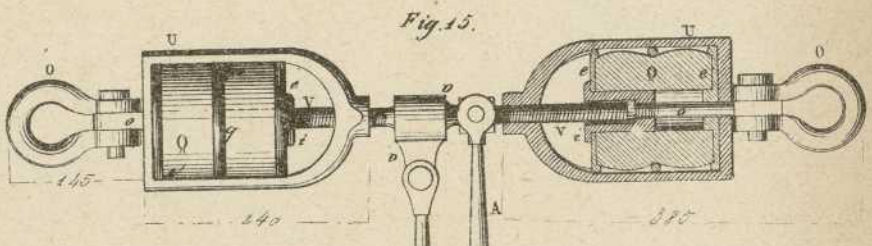
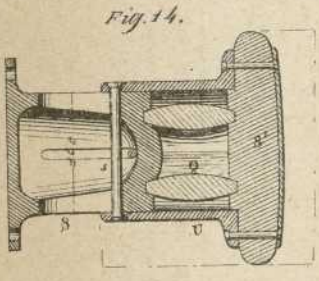
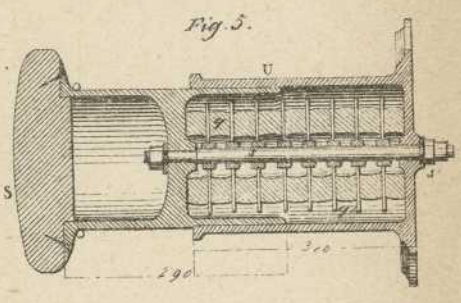
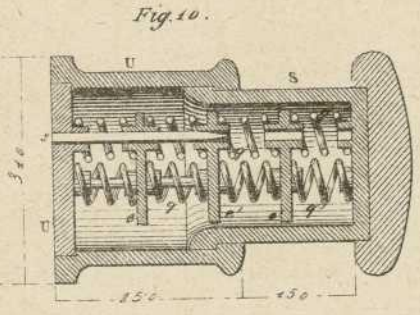
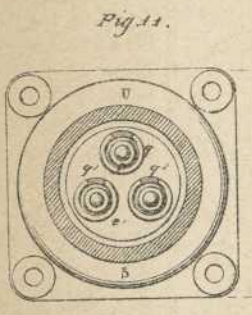
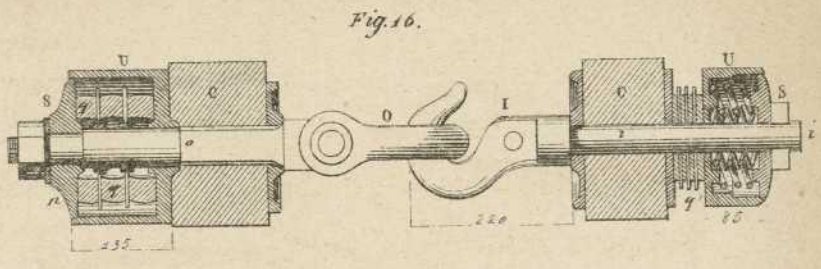
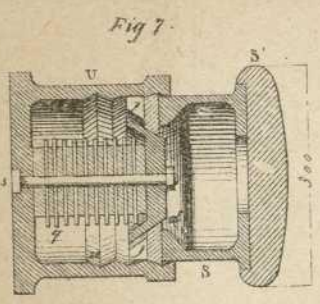


N. com. s. edito.



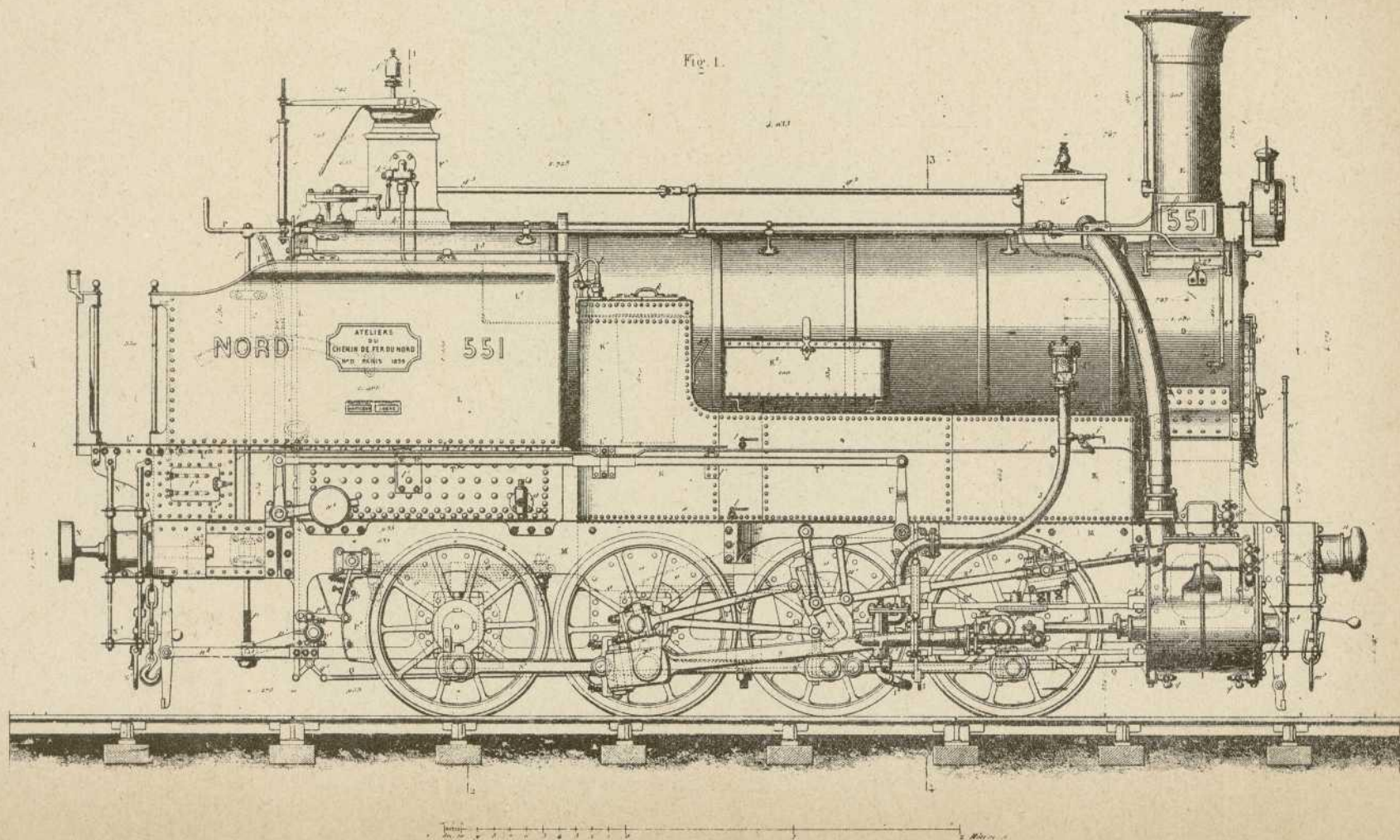
Escala de 1/85 para las Fig. 1 á 4.

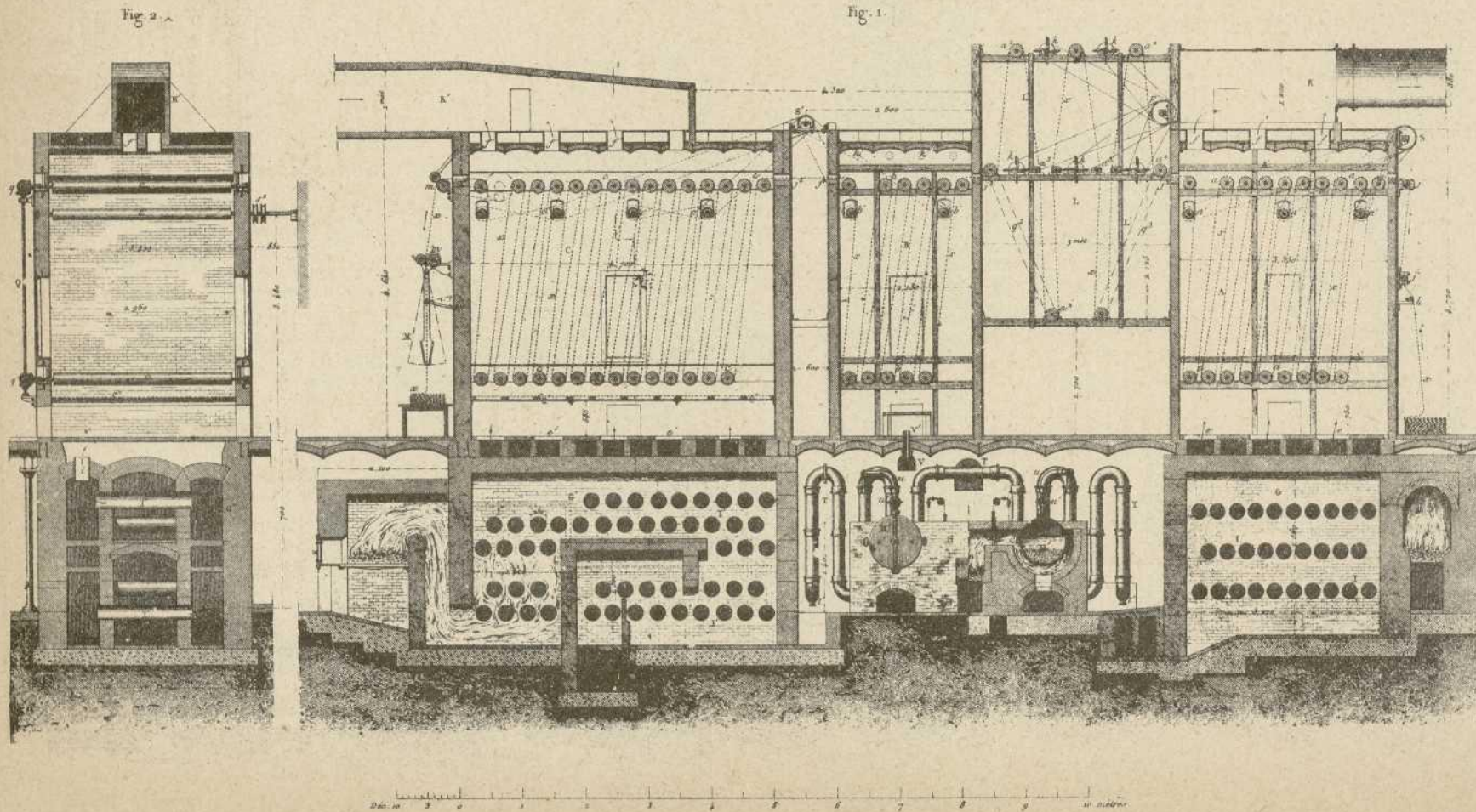


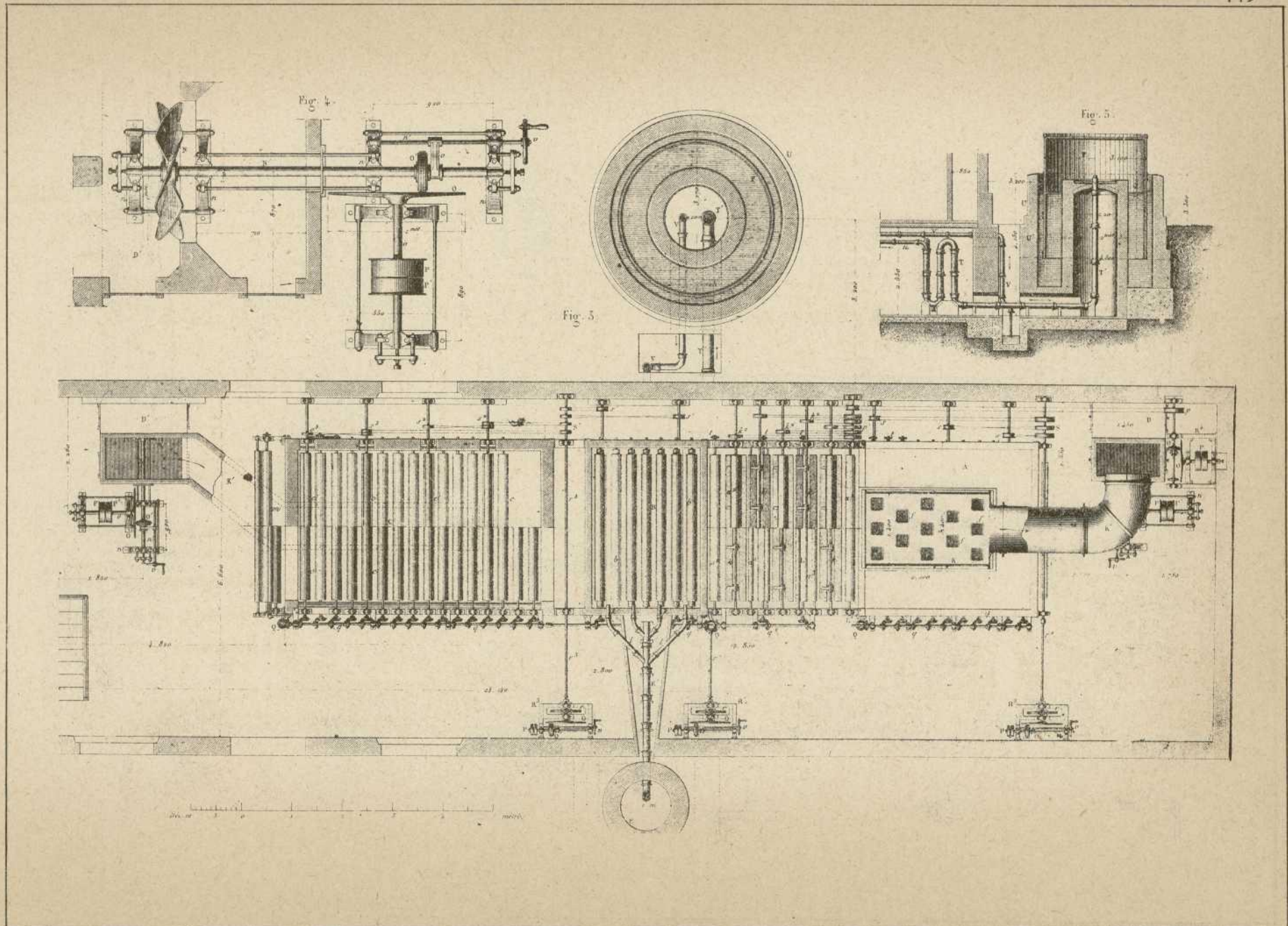


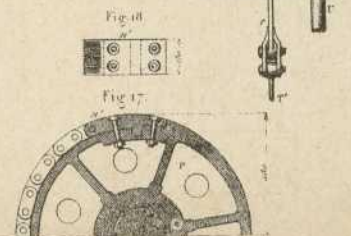
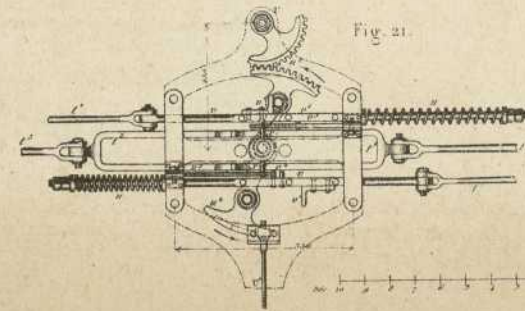
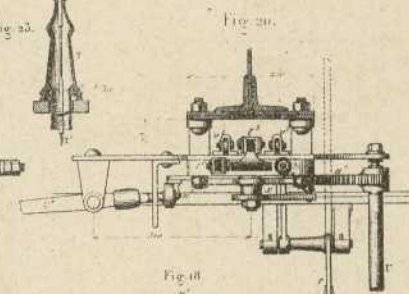
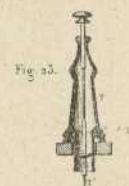
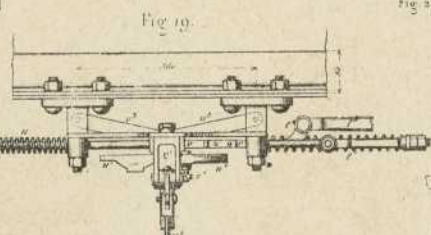
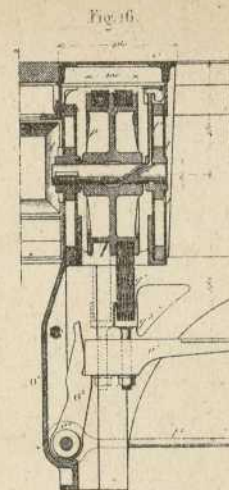
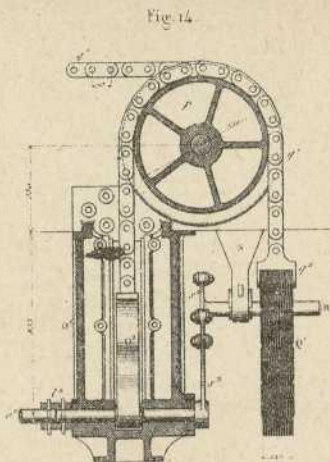
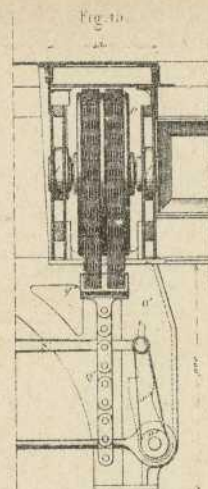
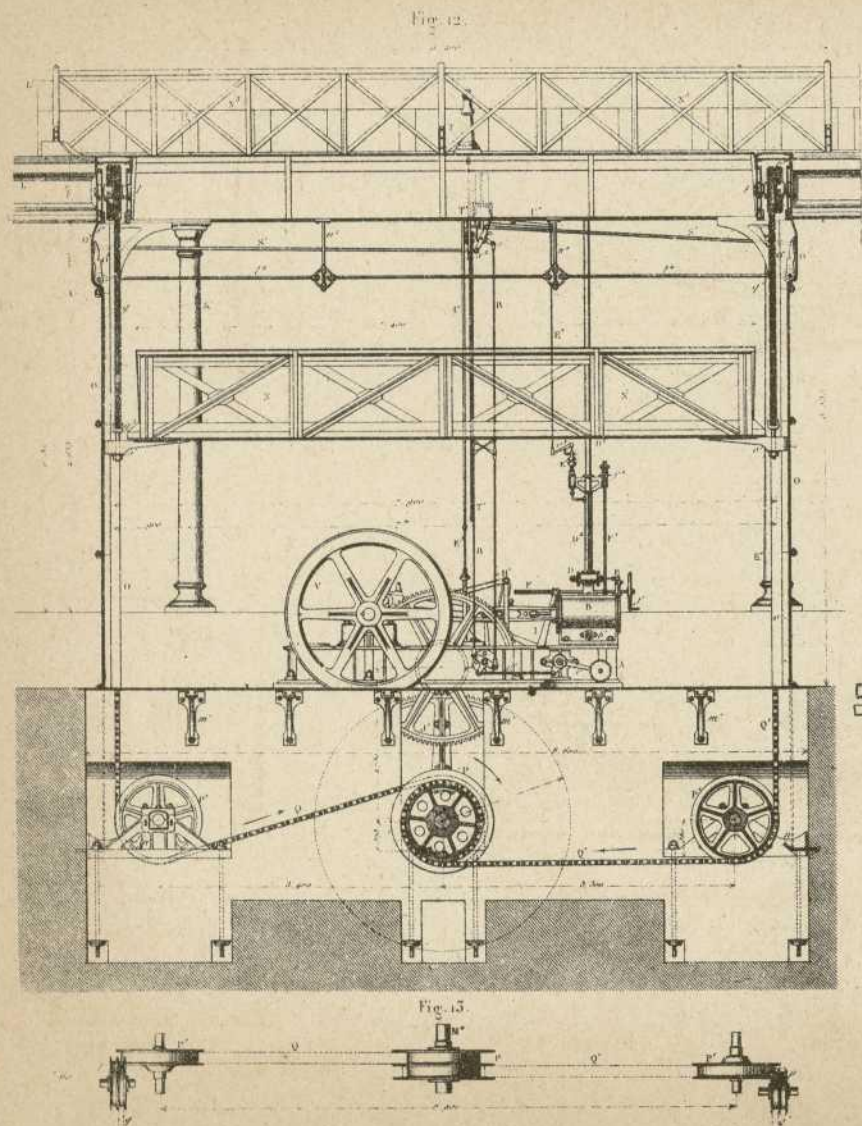
Escala de 1/10 por las Fig. 5 á 14 y 16 á 18.











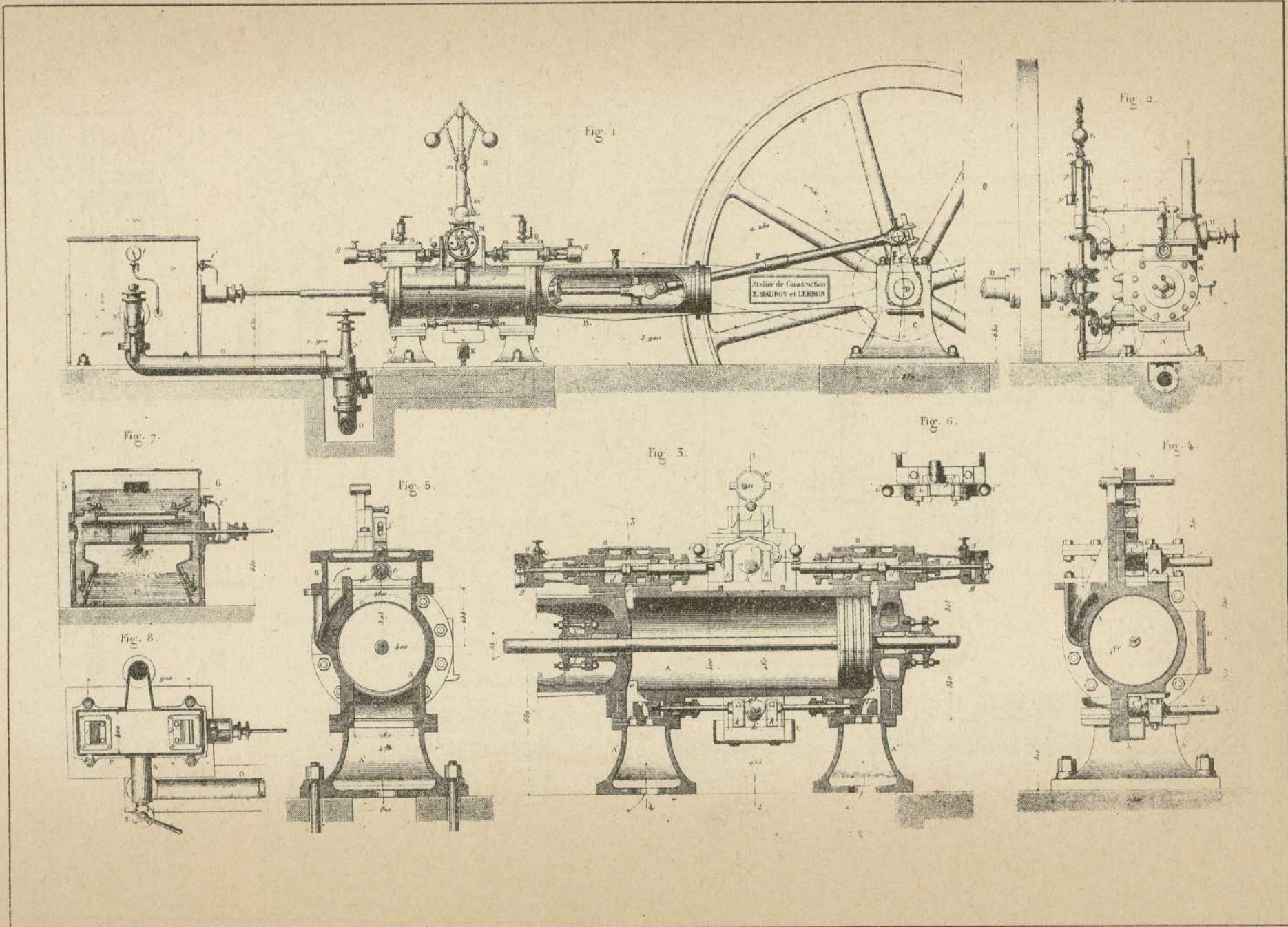


Fig. 1.

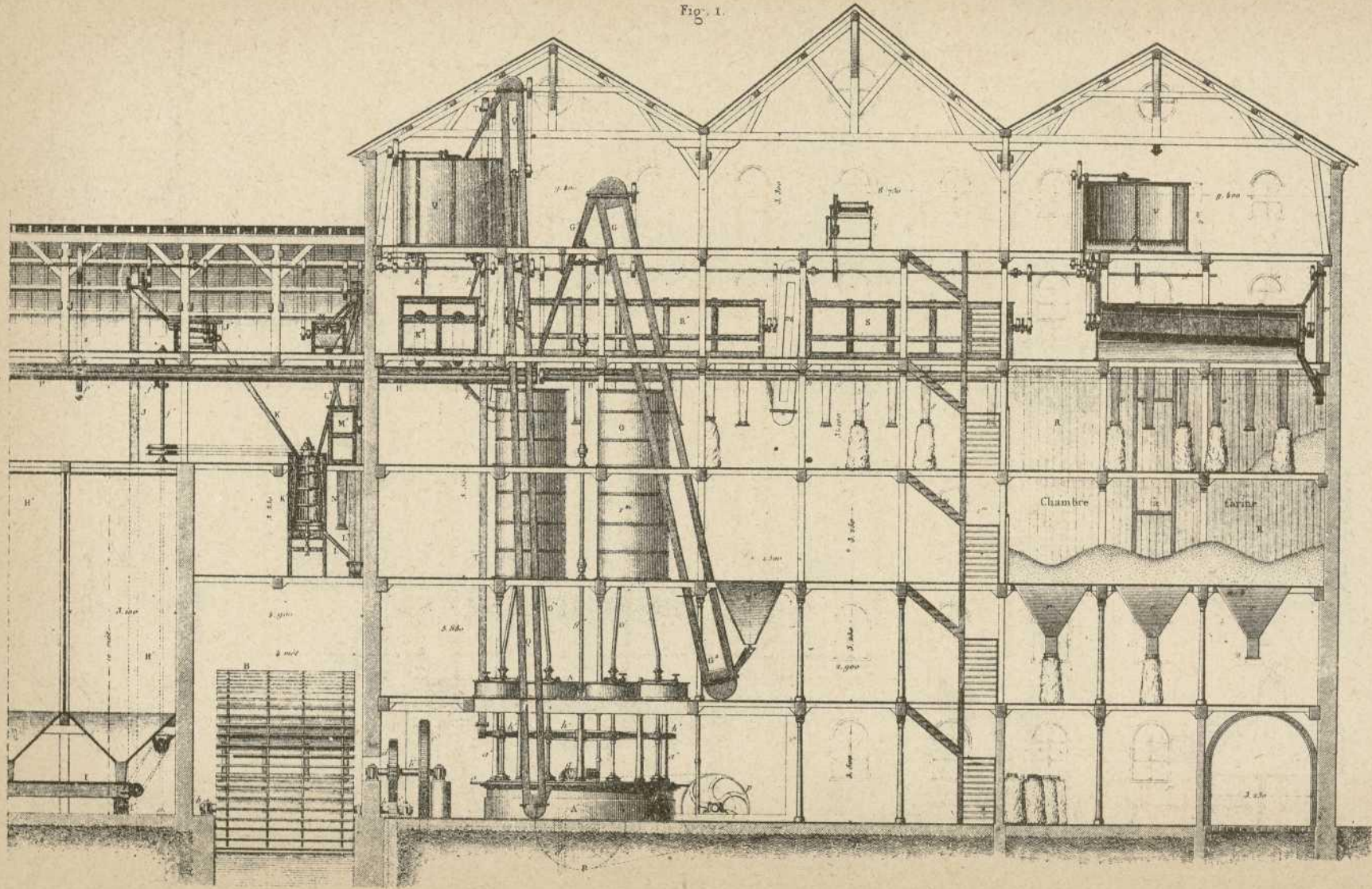
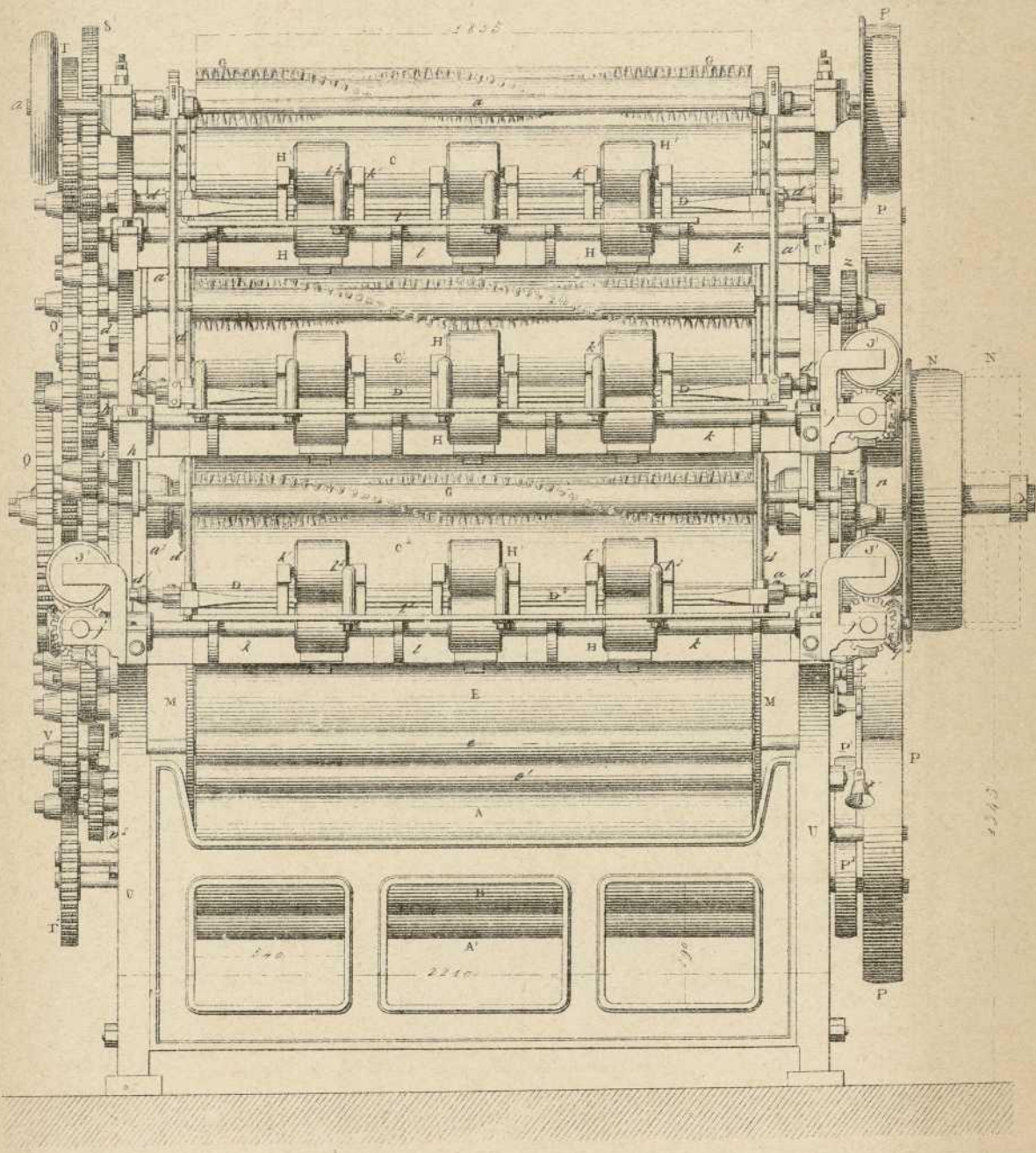


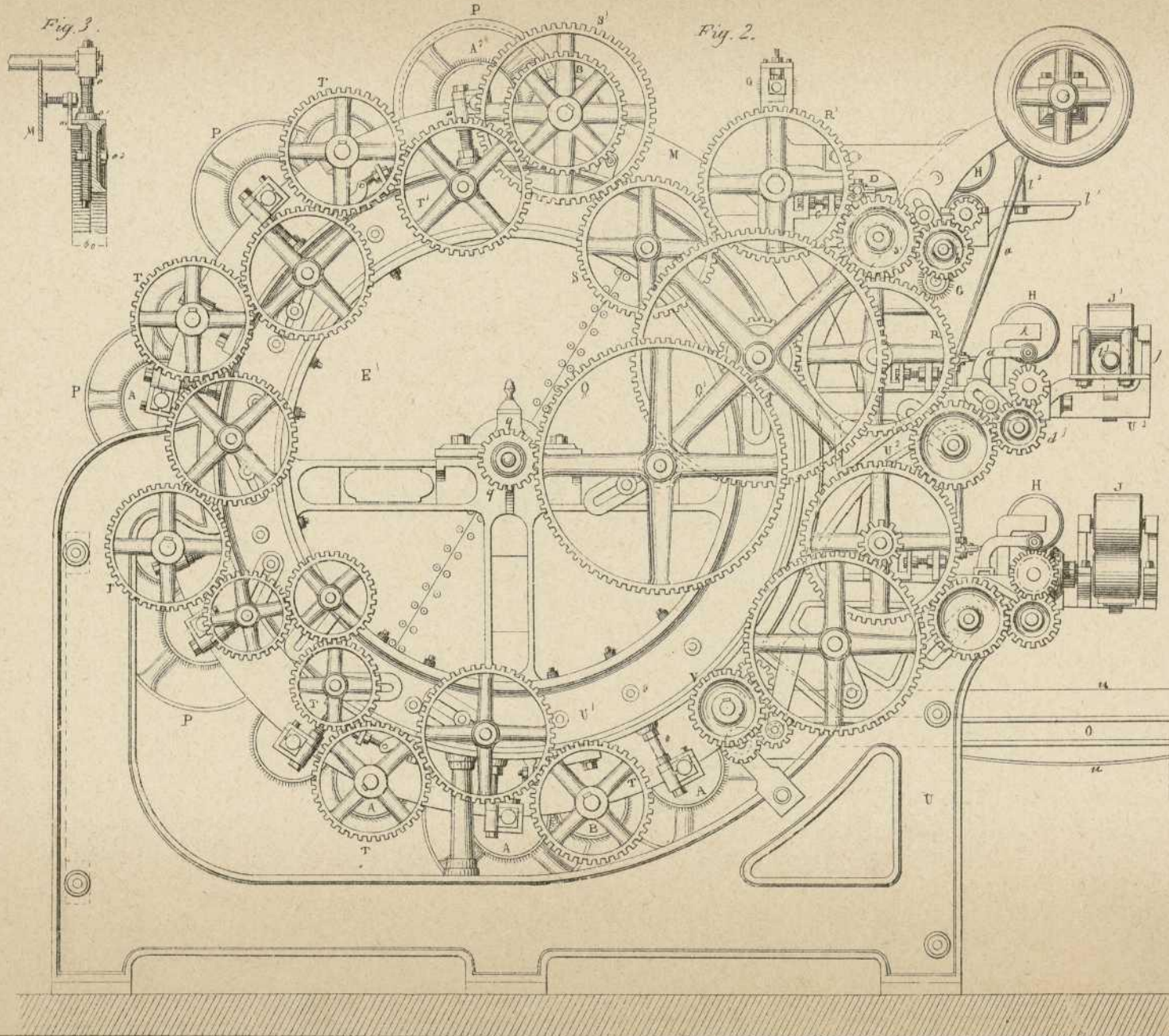
Fig. 1.

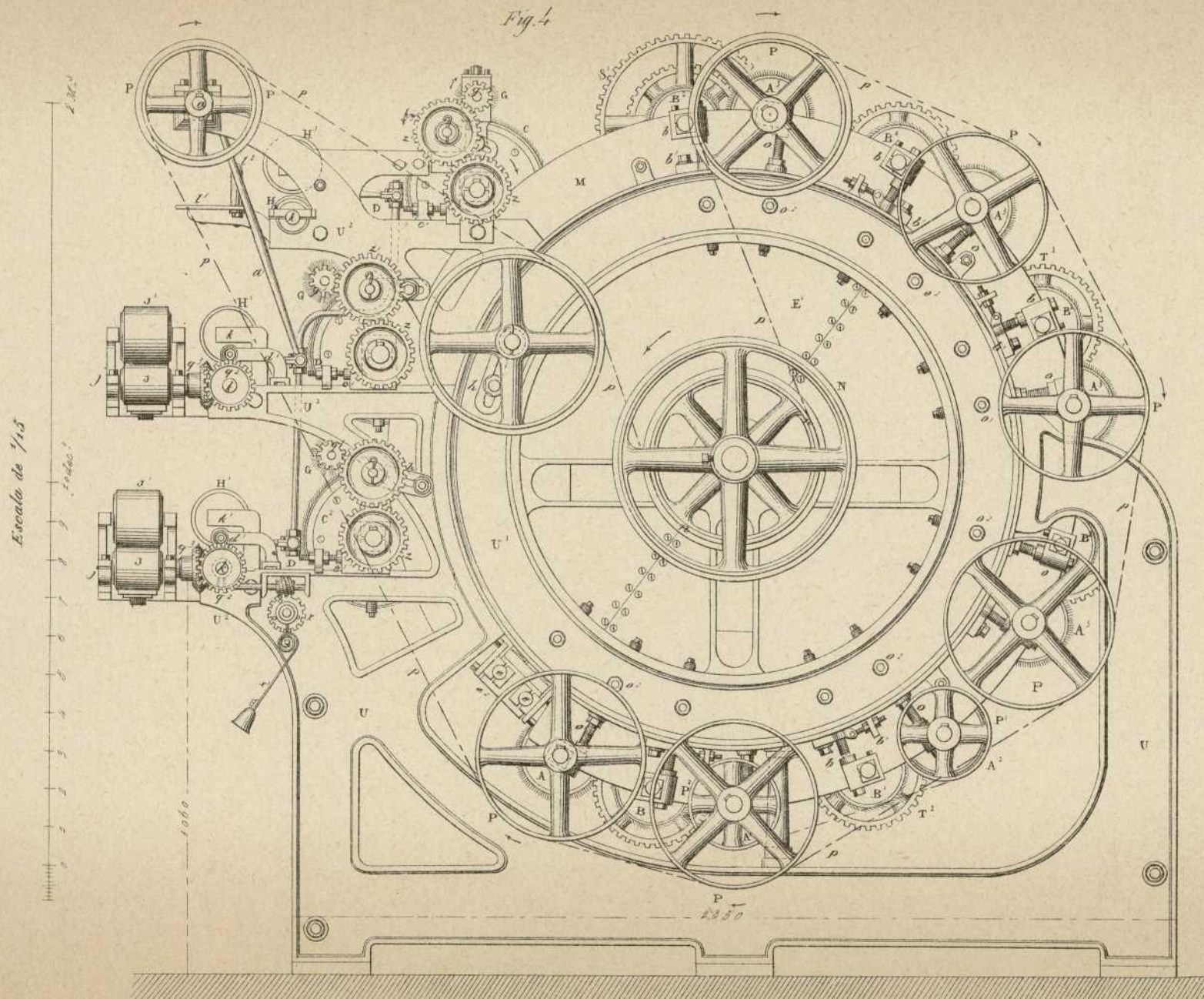


Escala de 1/15.

0 1 2 3 4 5 6 7 8 9 10 cm

2210





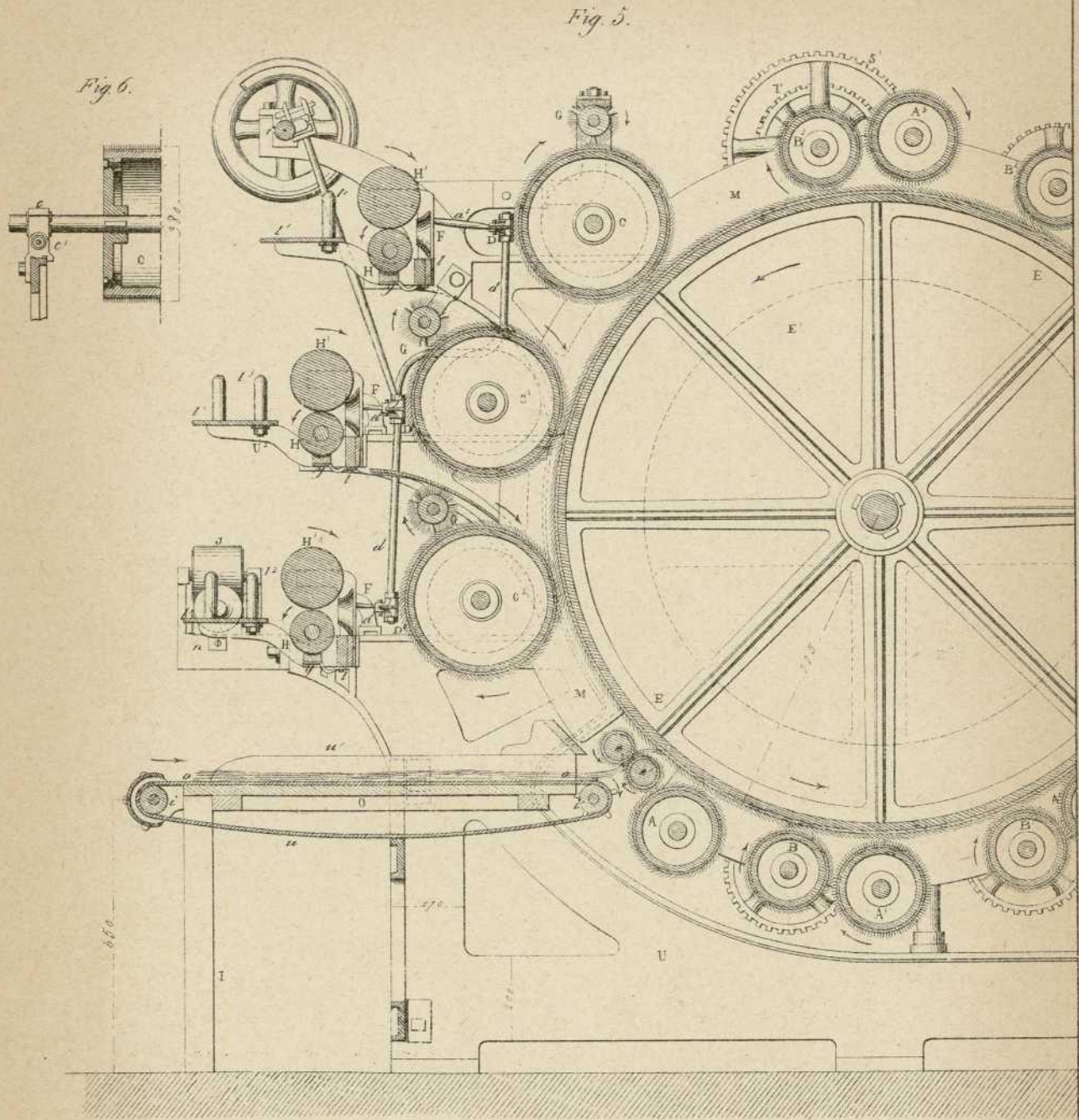


Fig. 7.

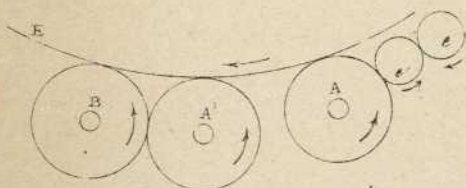
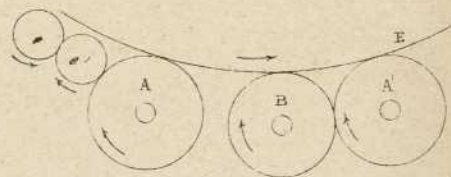
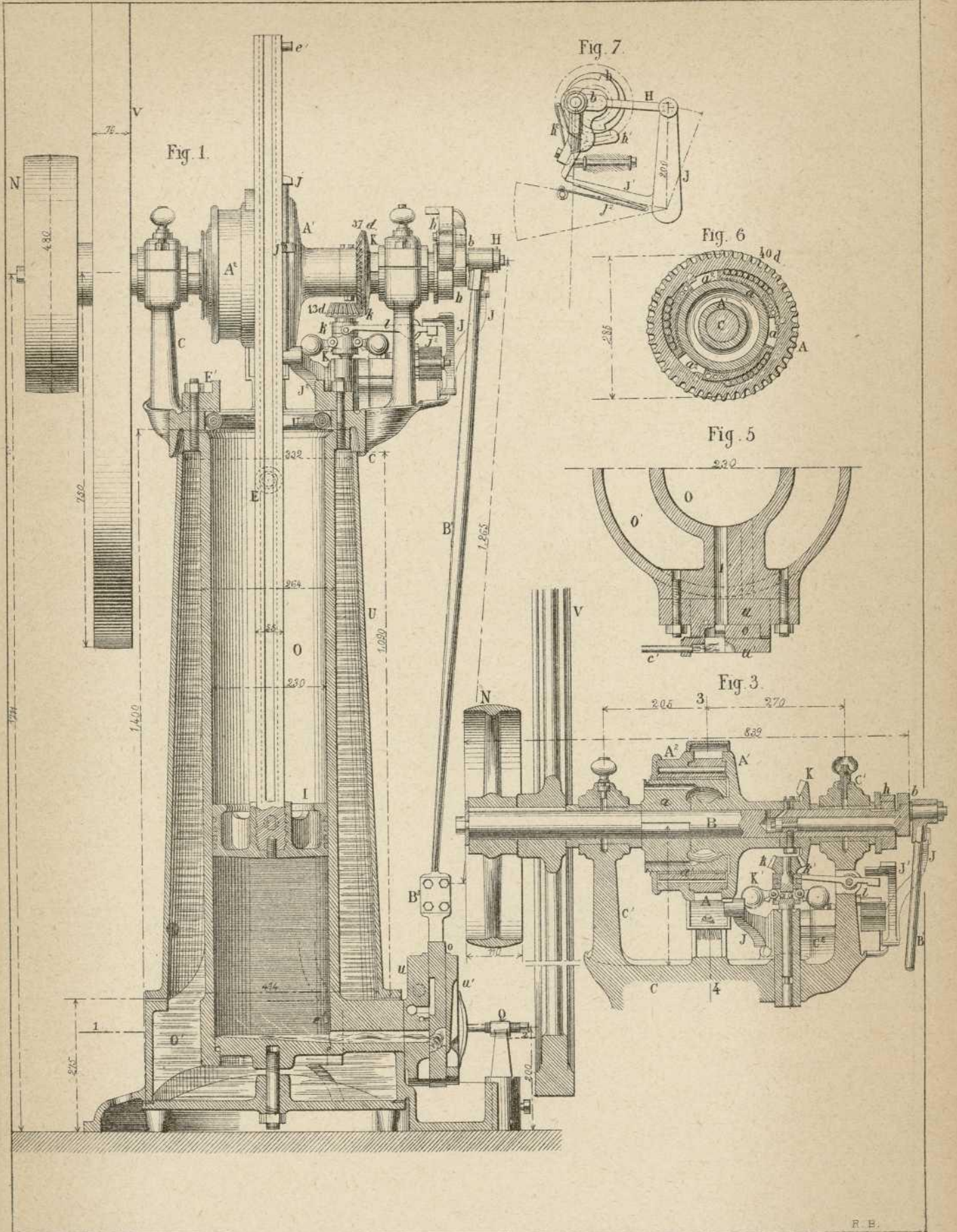


Fig. 8.





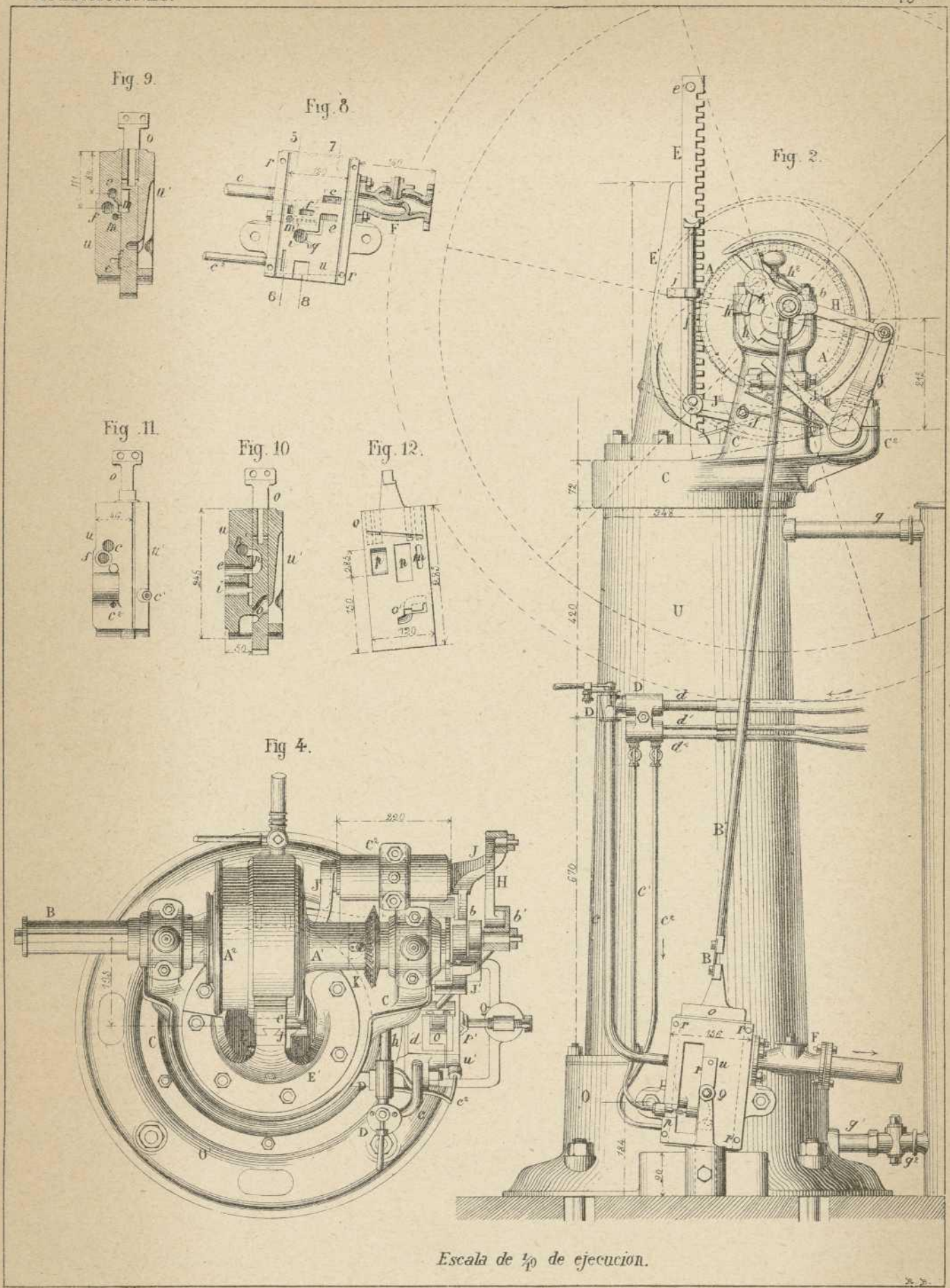


Fig. 13

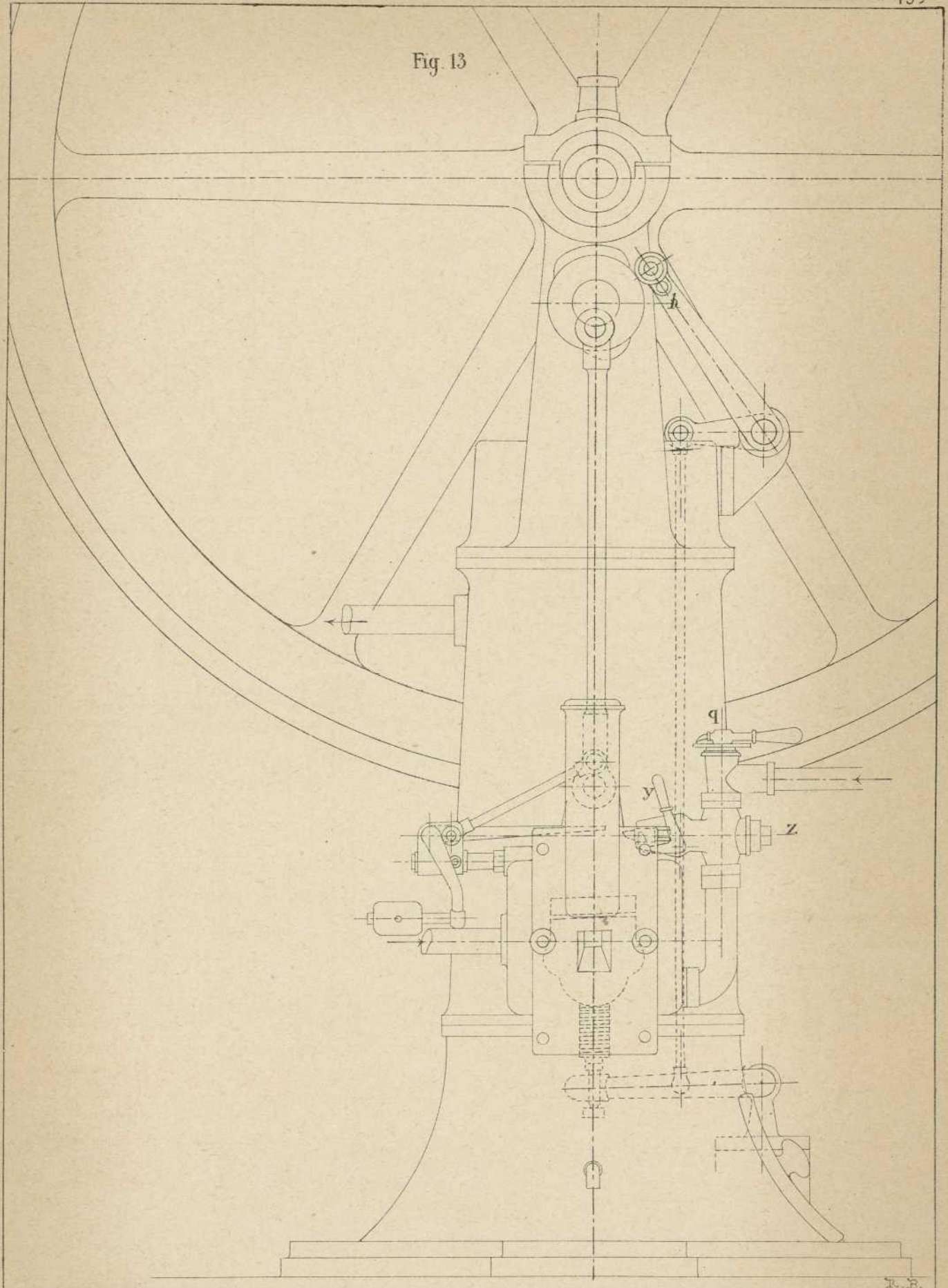
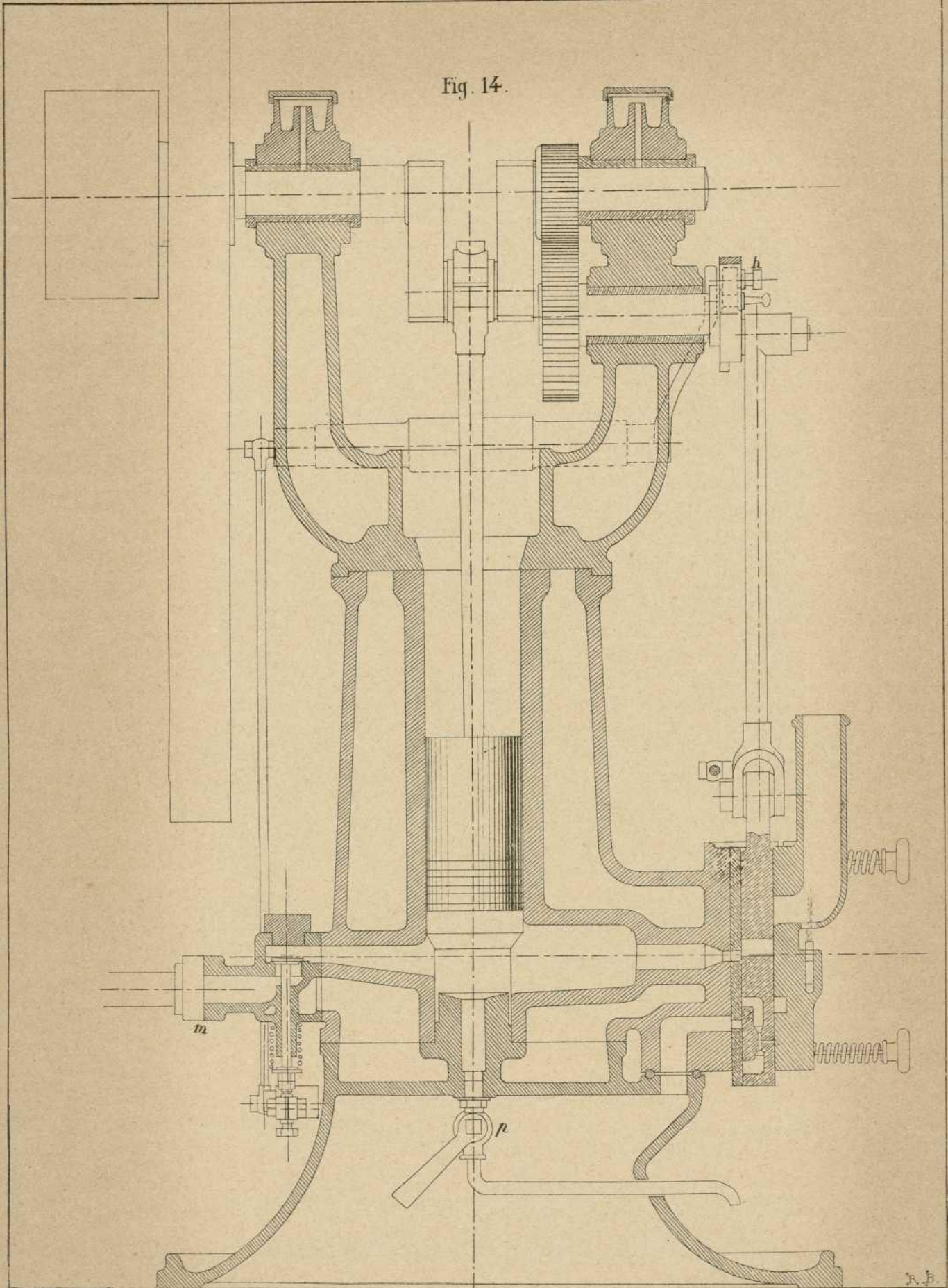


Fig. 14.



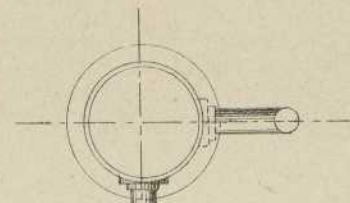


Fig 15.

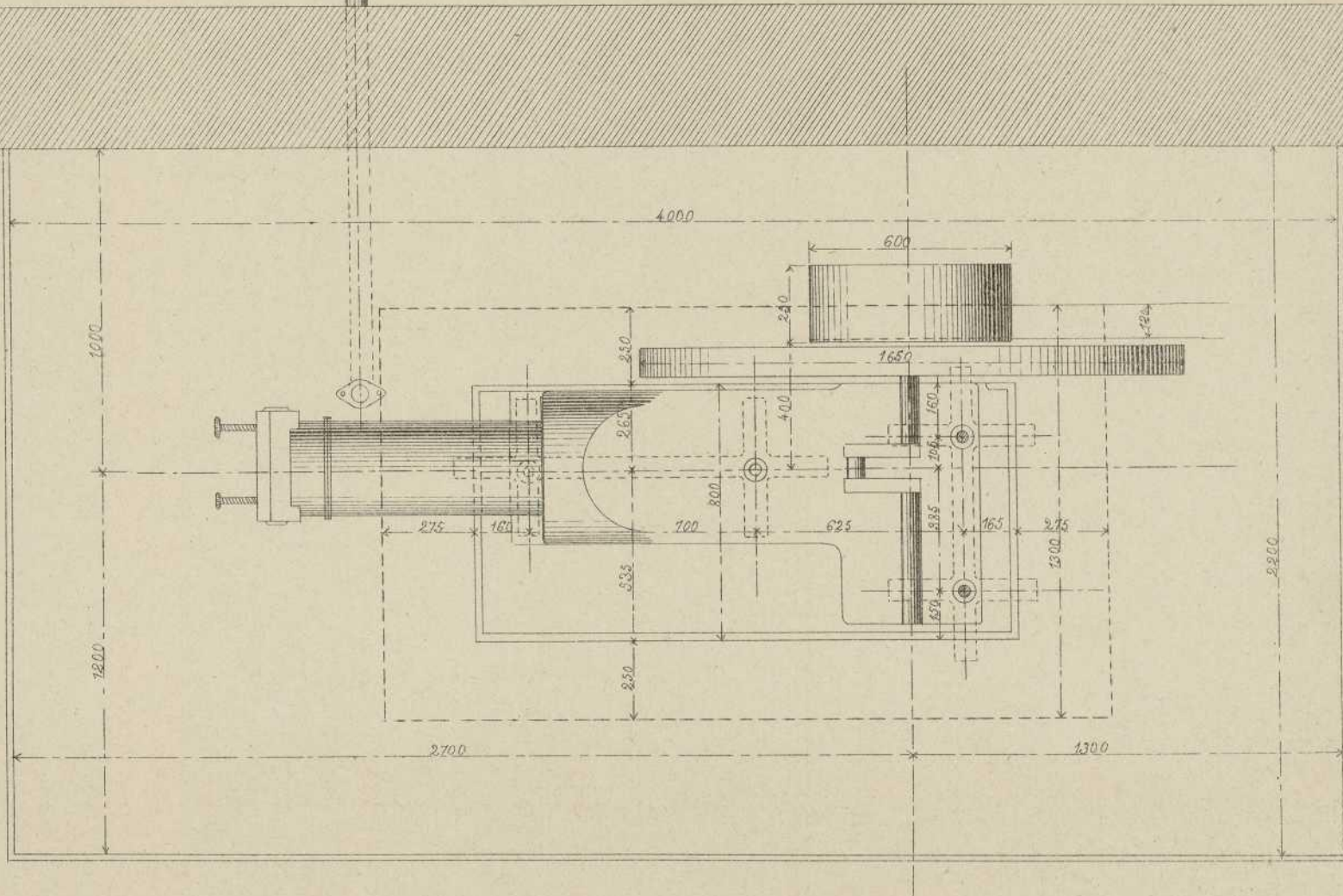


Fig. 16.

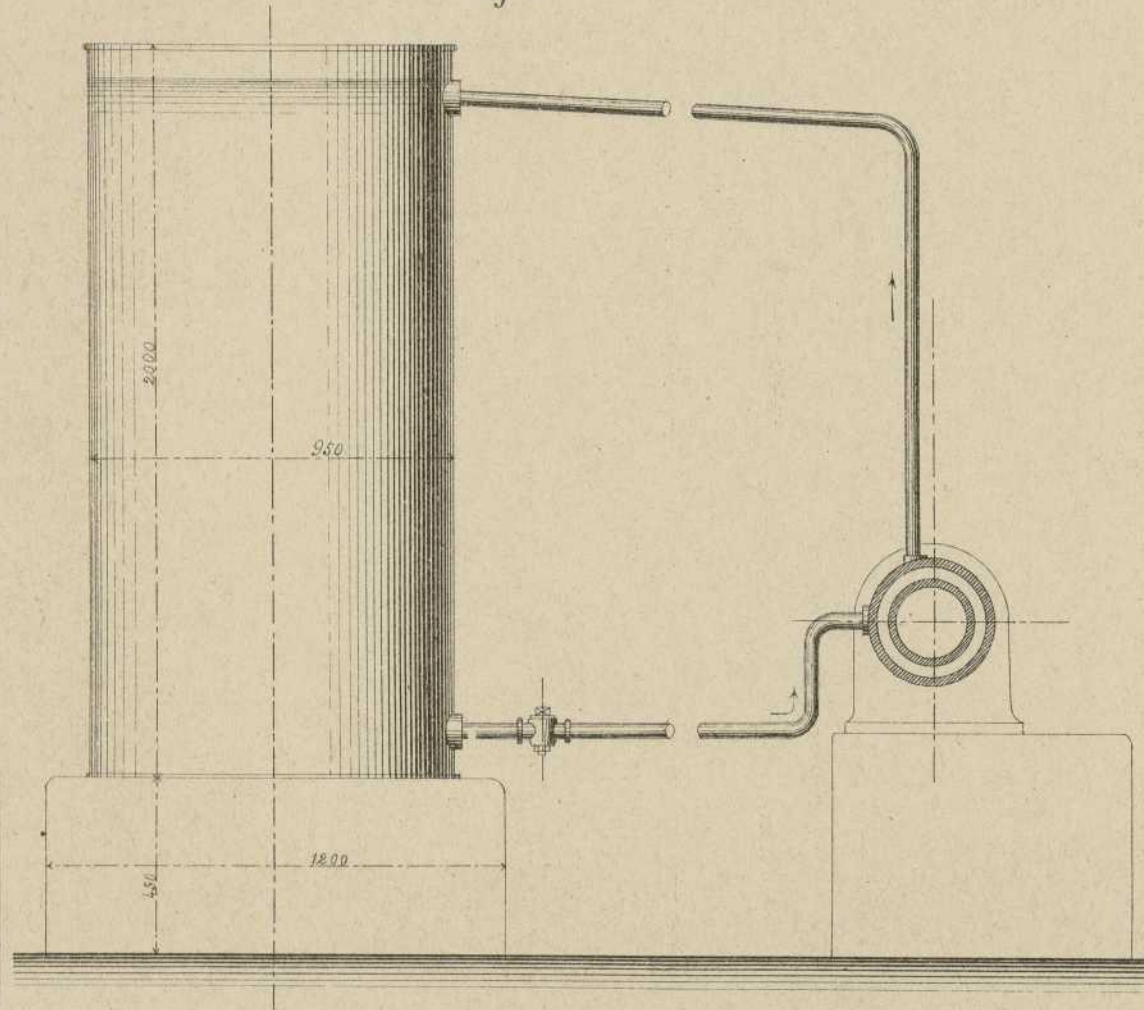
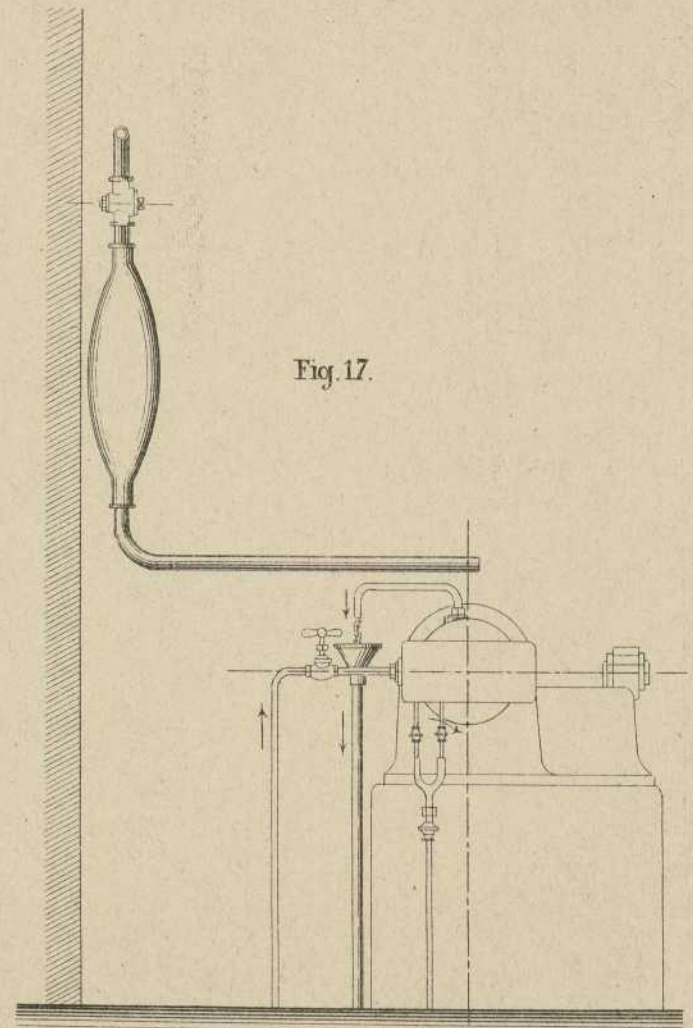
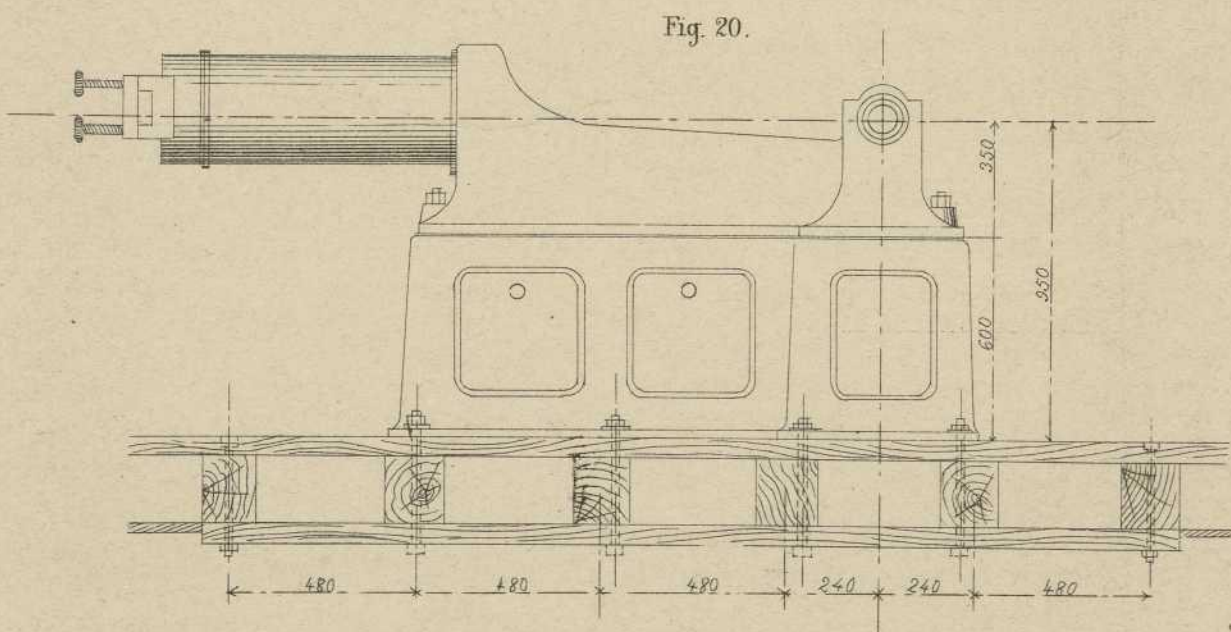
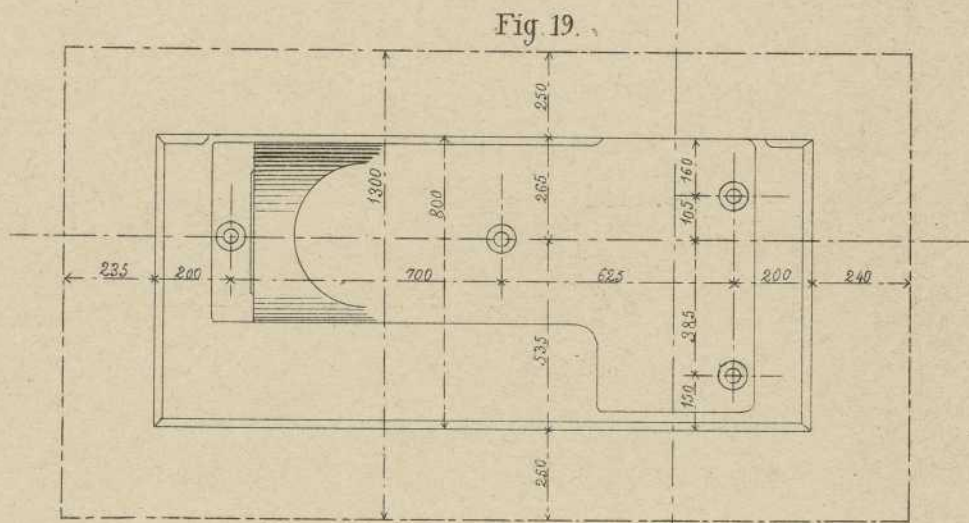
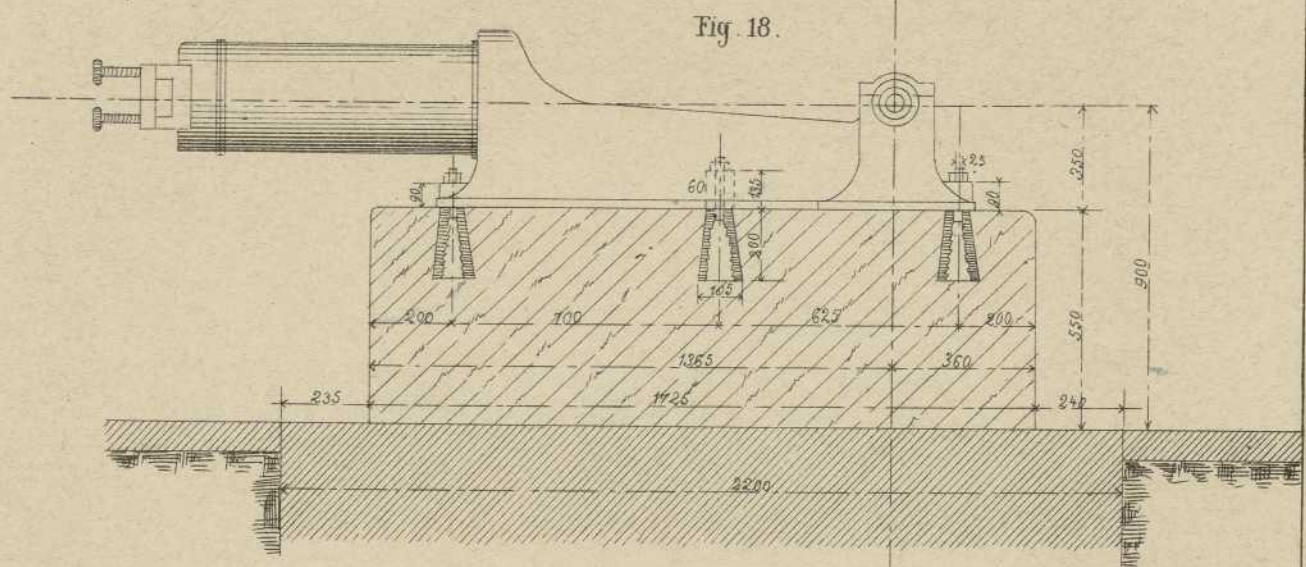


Fig. 17.





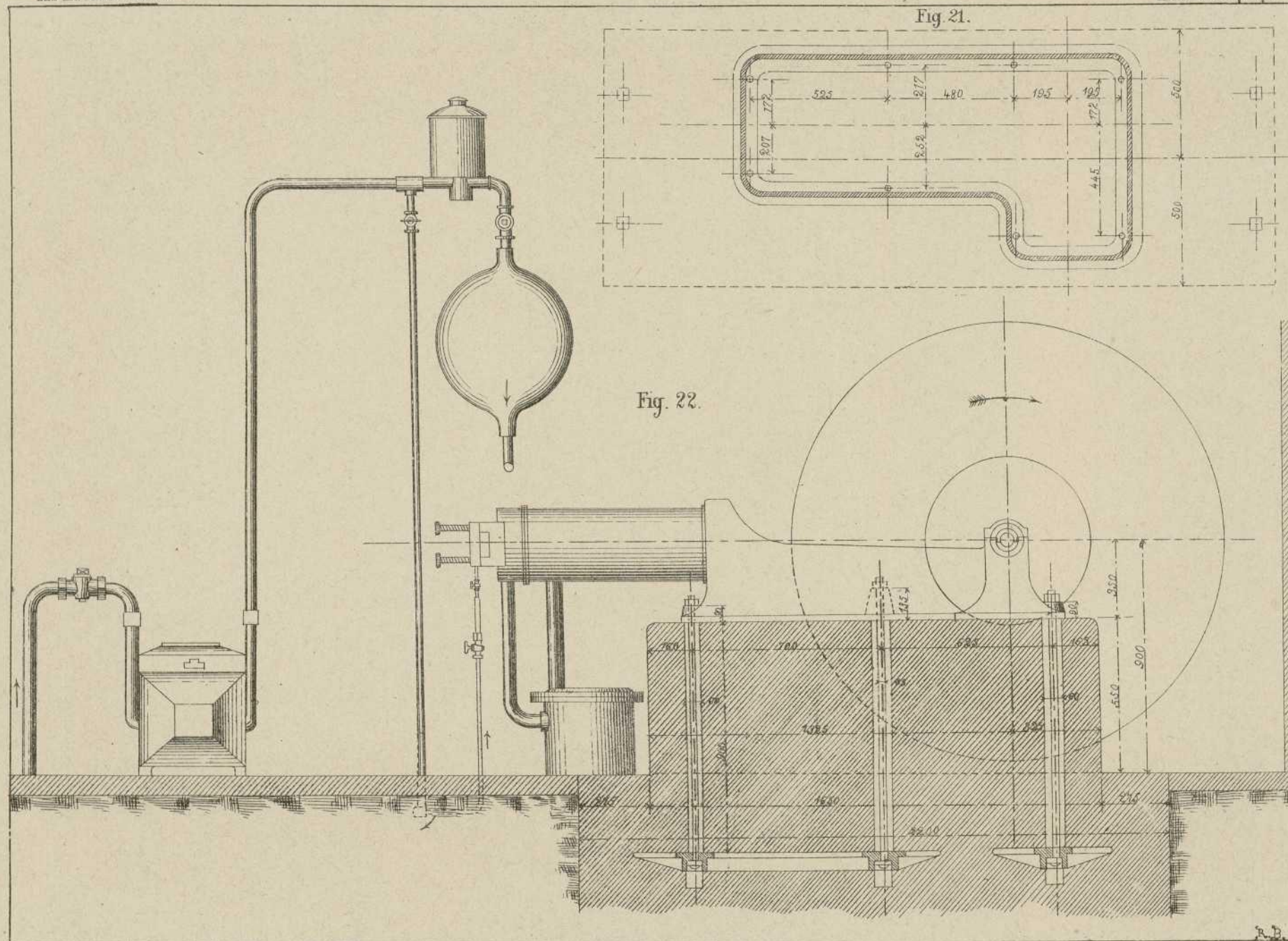


Fig. 22.

Fig. 21.

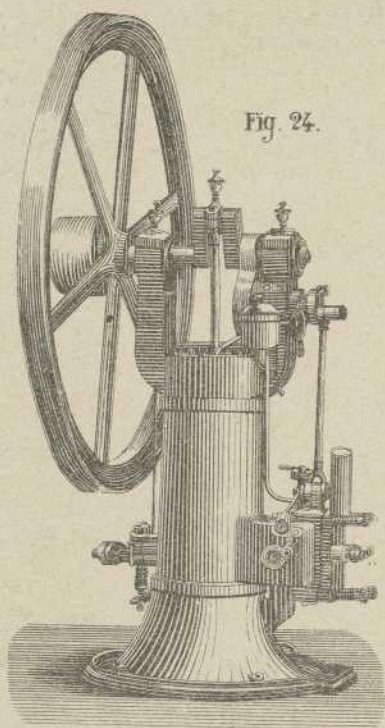


Fig. 24.

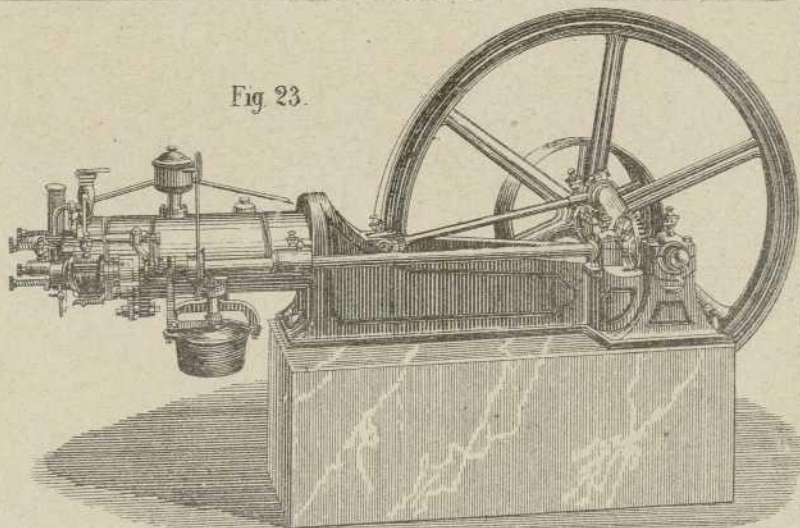


Fig. 23.

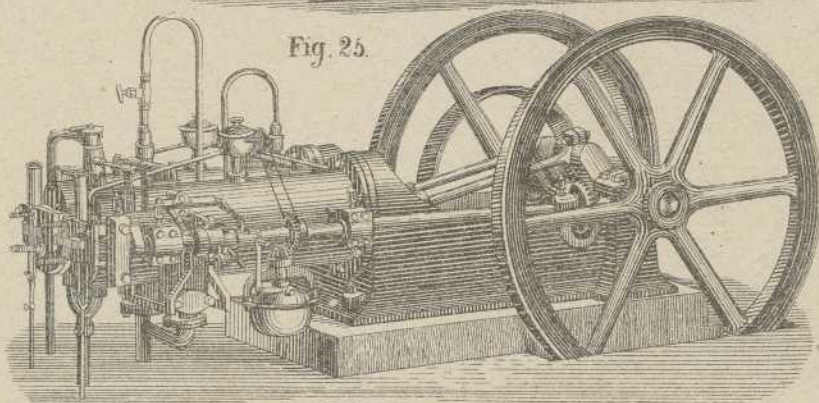


Fig. 25.

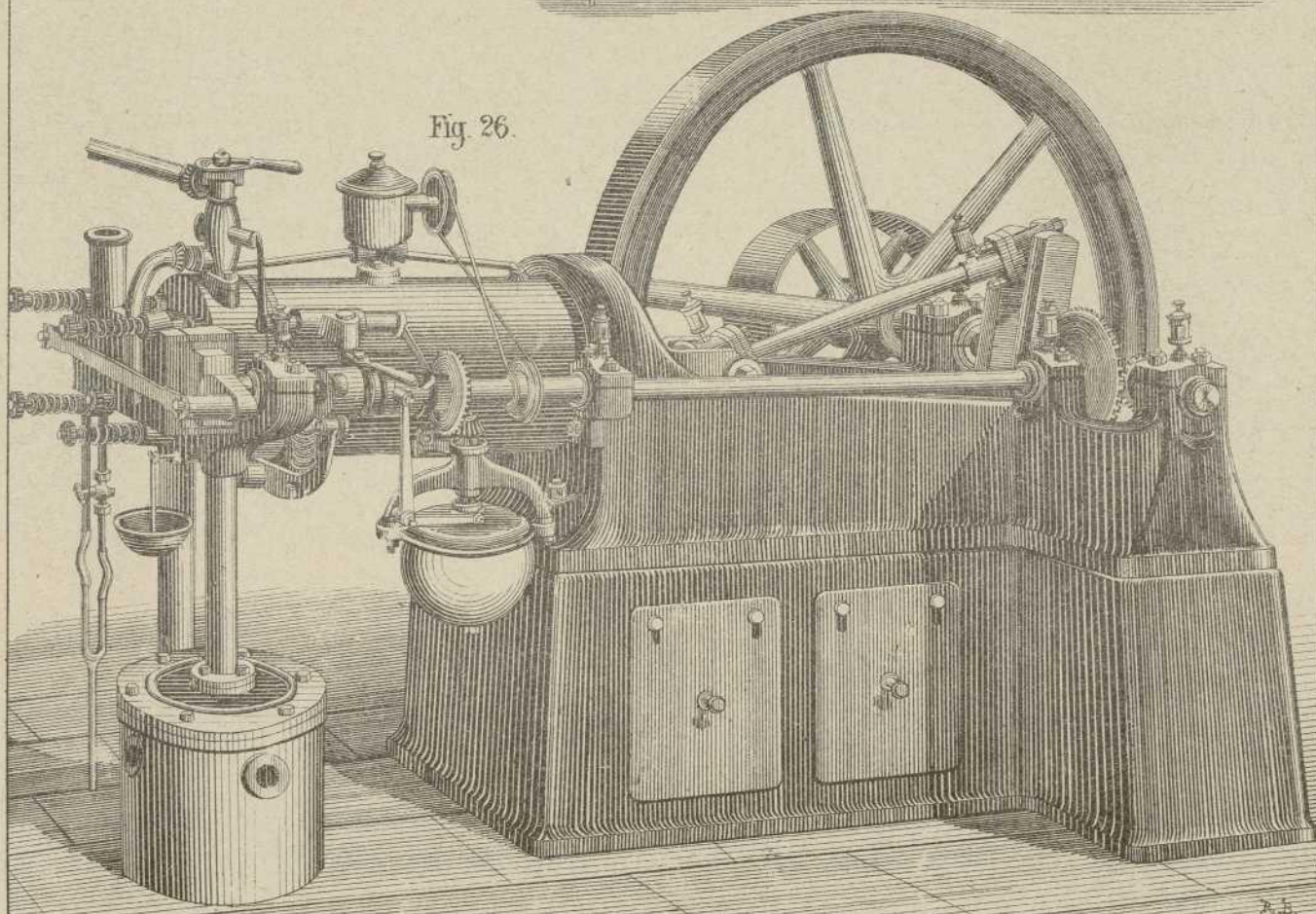
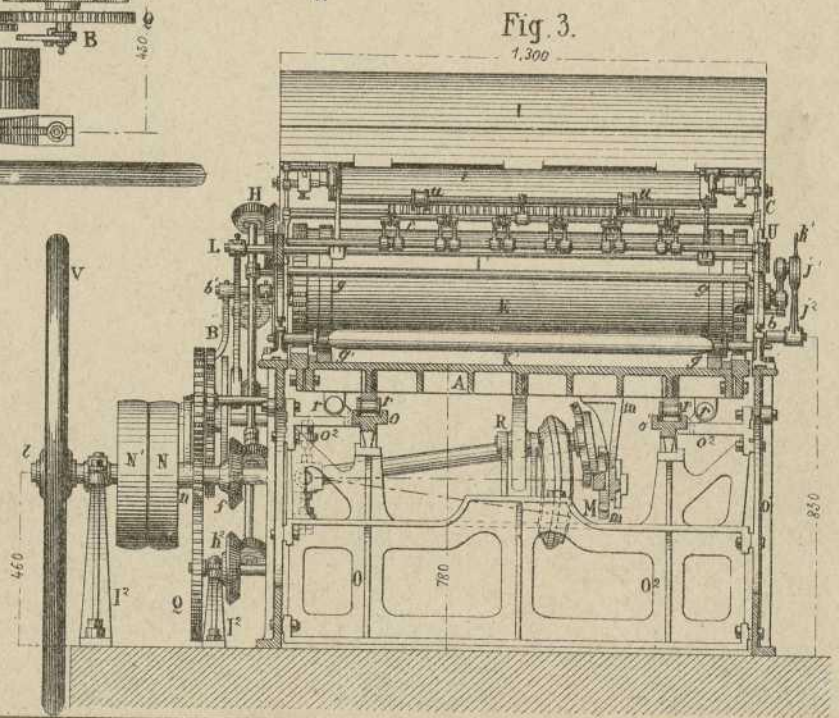
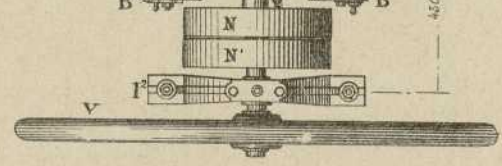
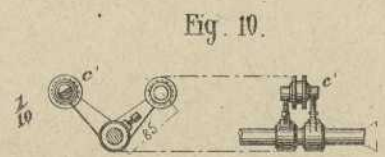
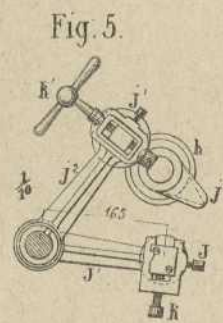
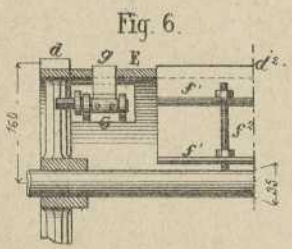
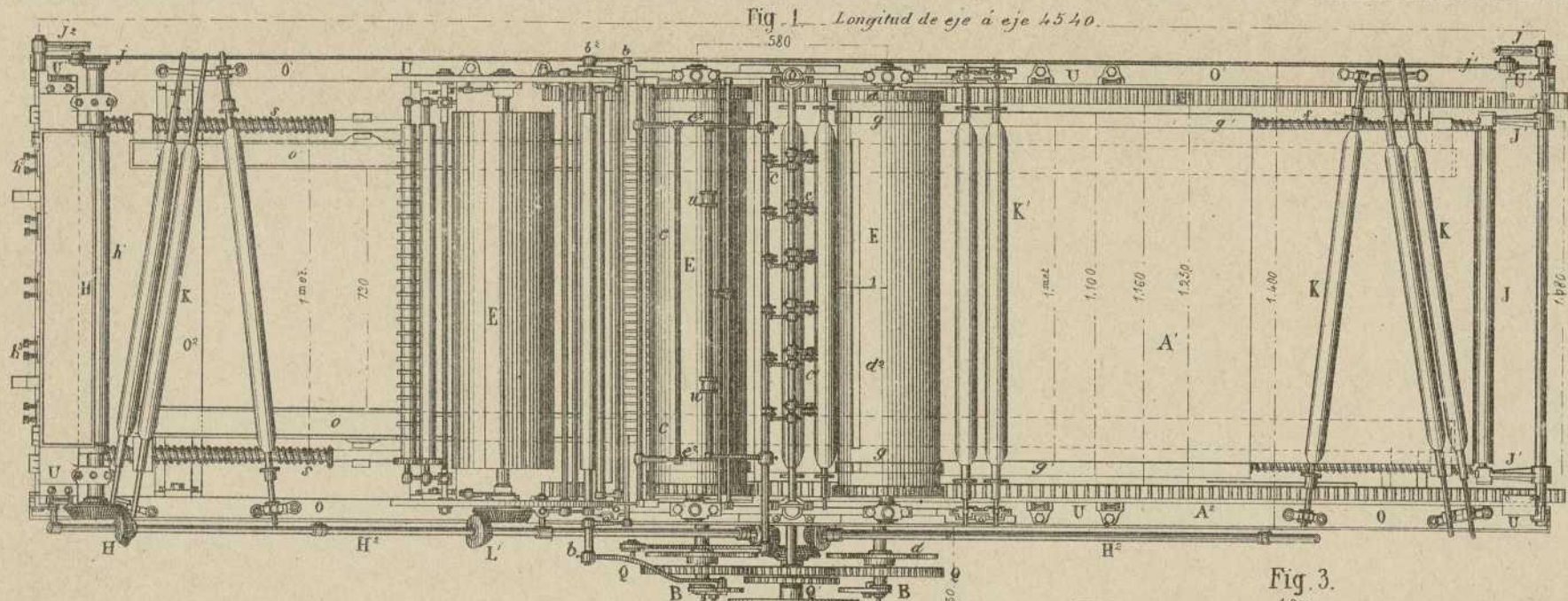
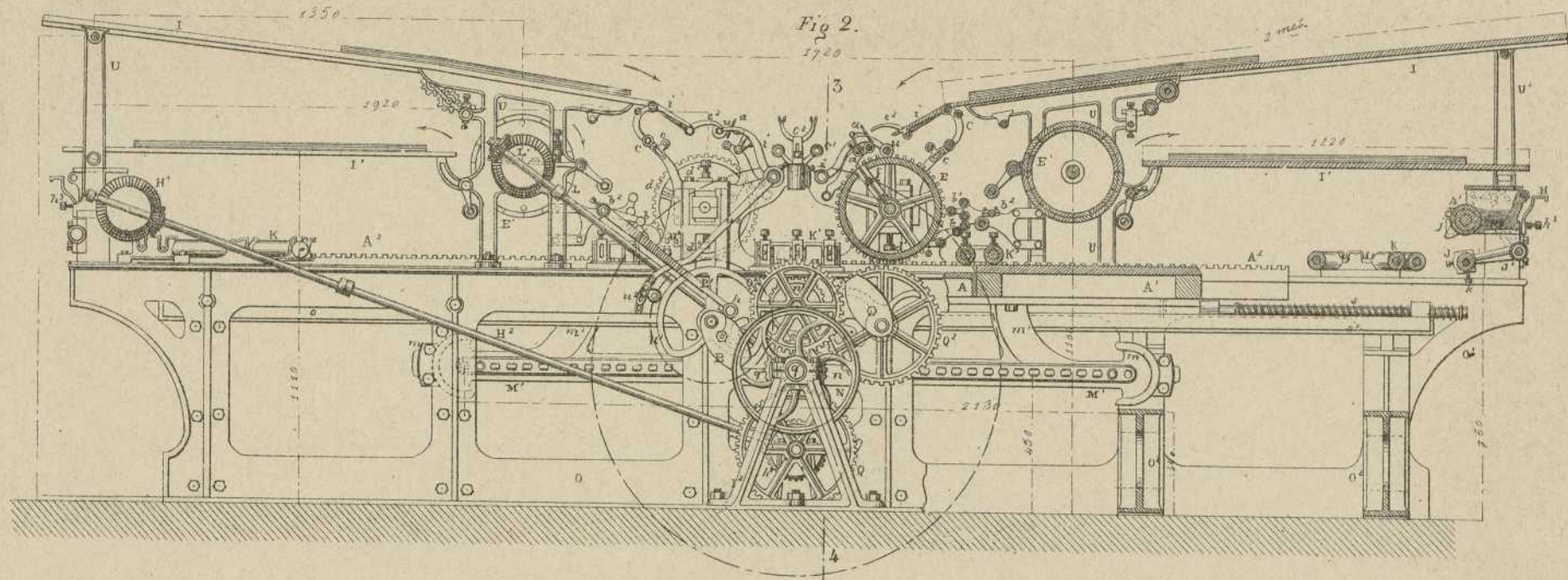


Fig. 26.





Curso del marmol 22 1/3.

Fig. 4.

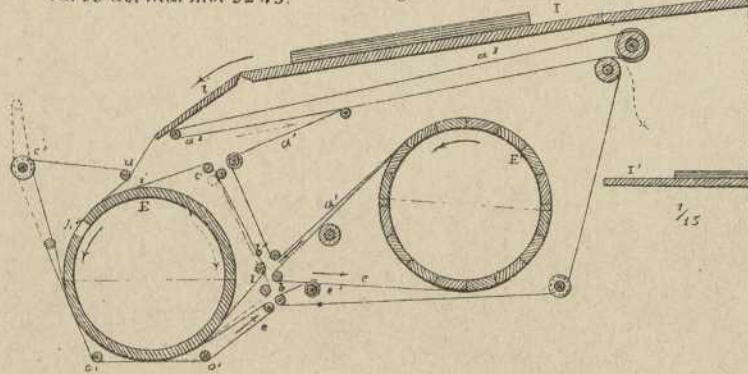


Fig. 8.



Fig. 9.

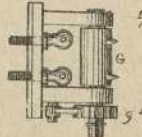
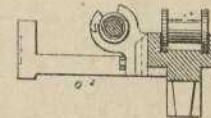


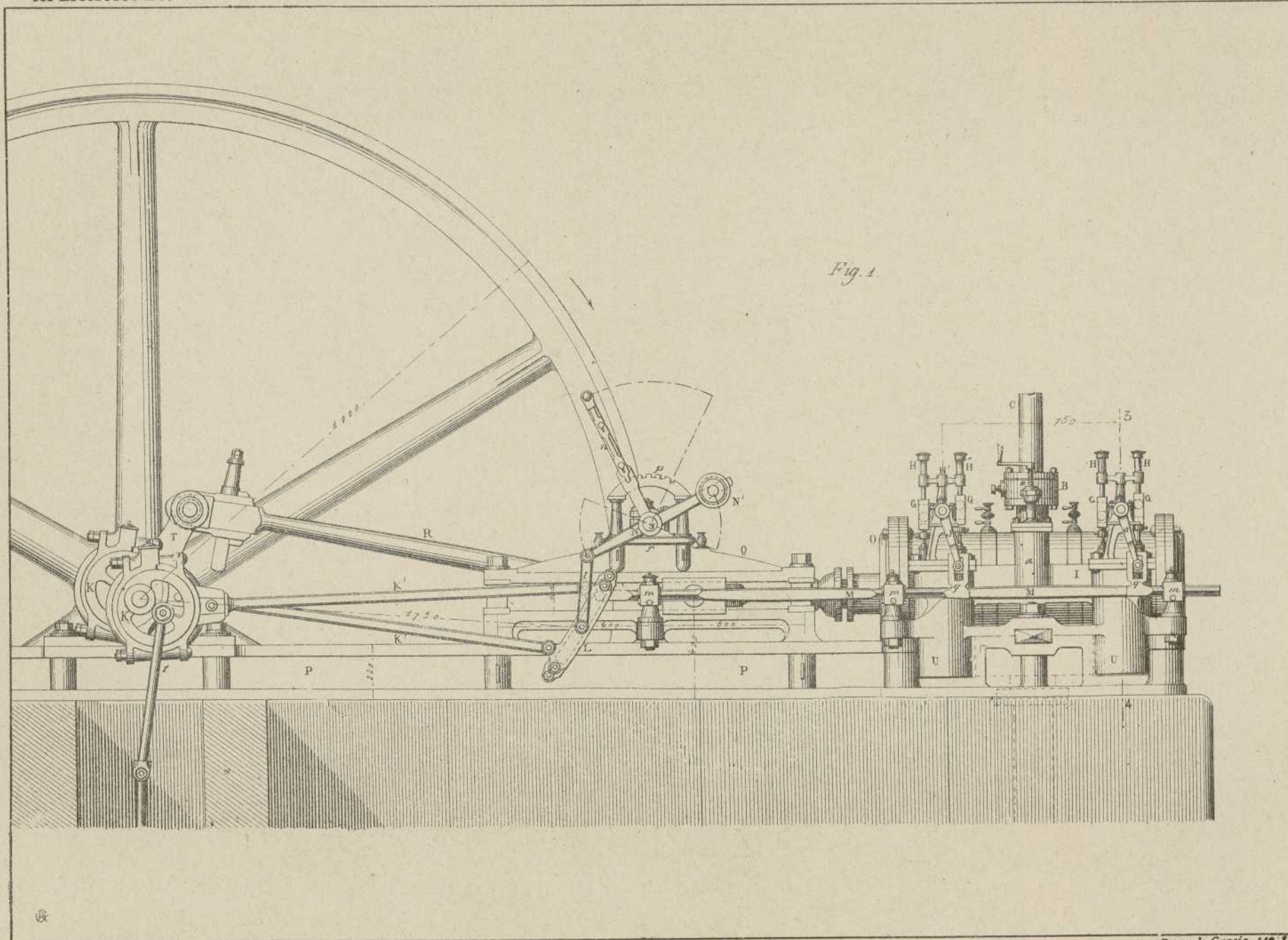
Fig. 7.

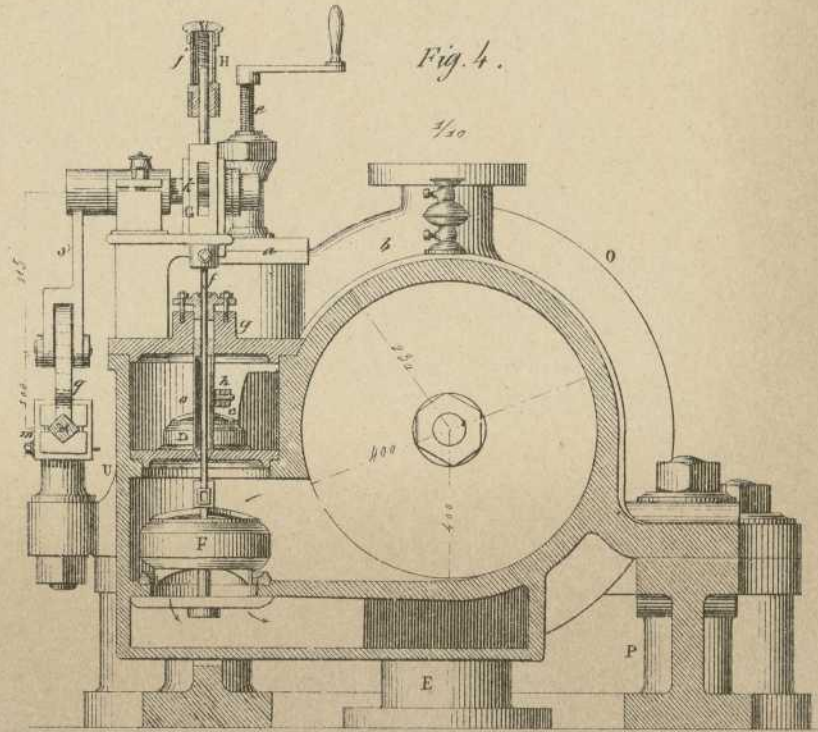
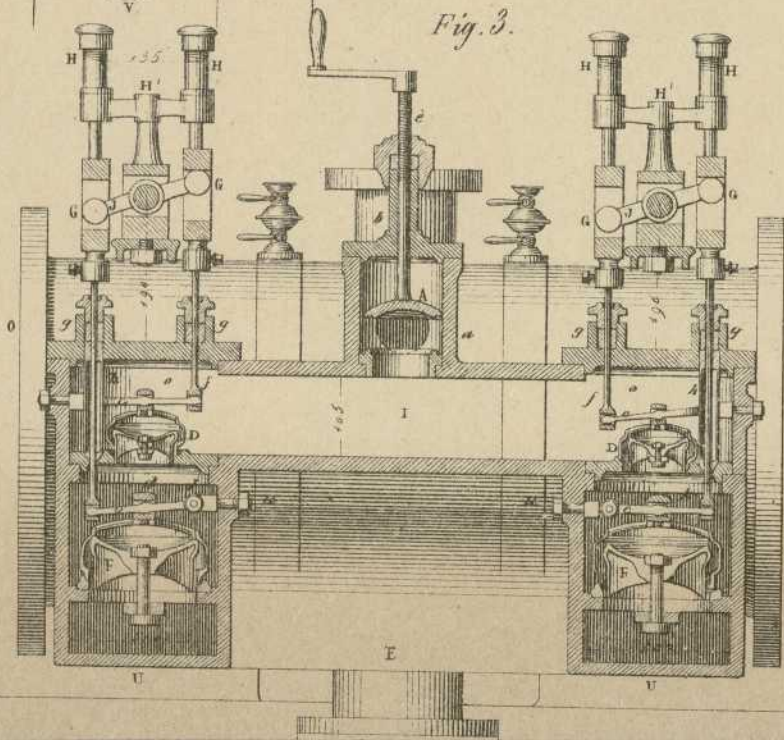
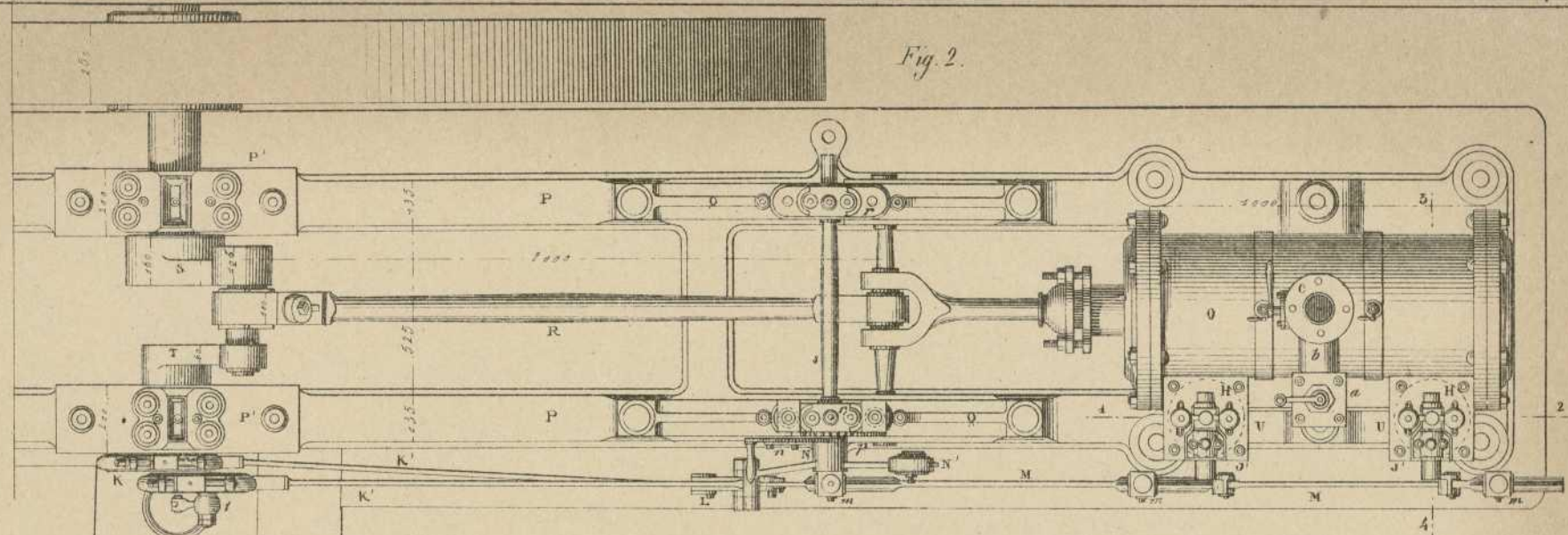


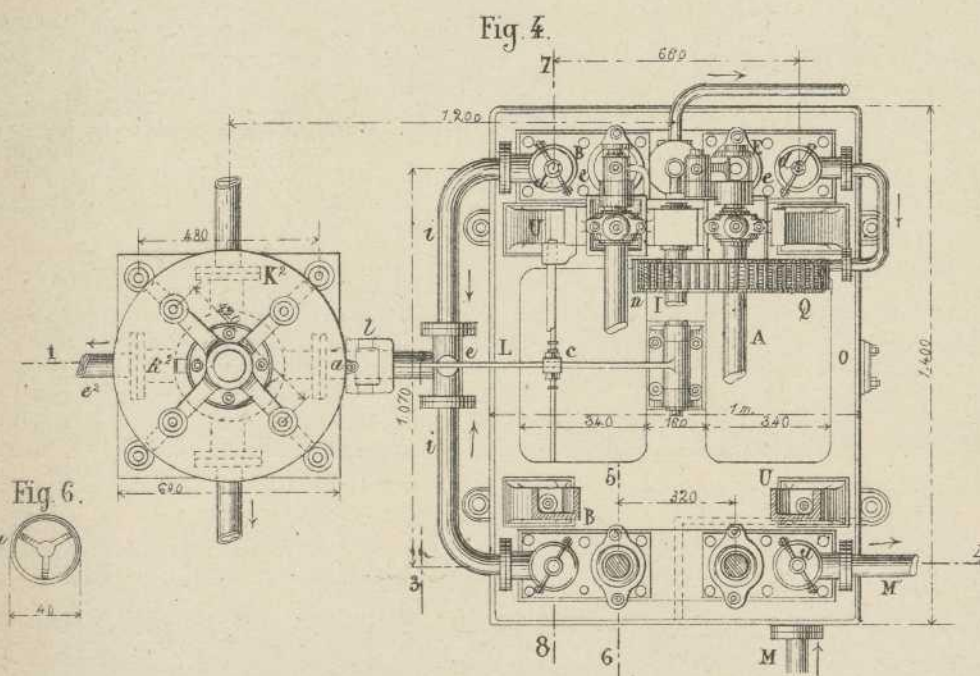
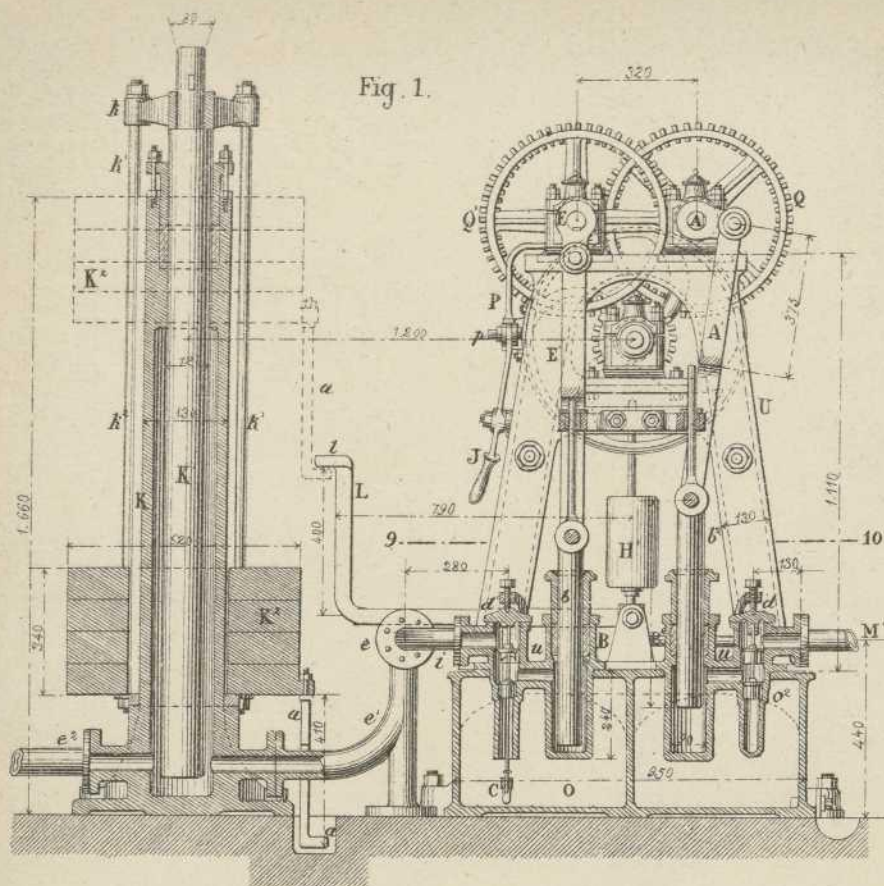
Escala de 1/40 por las Fig. 1 á 3.

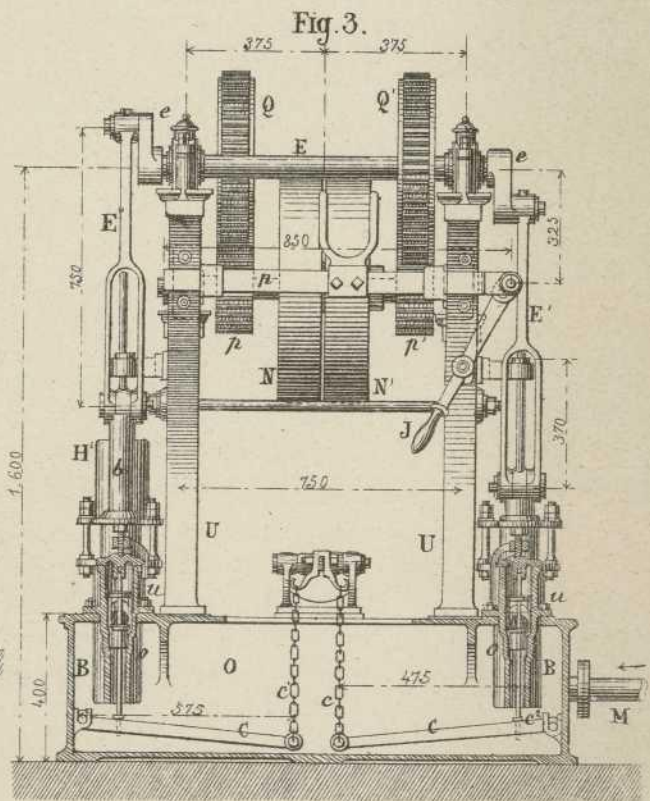
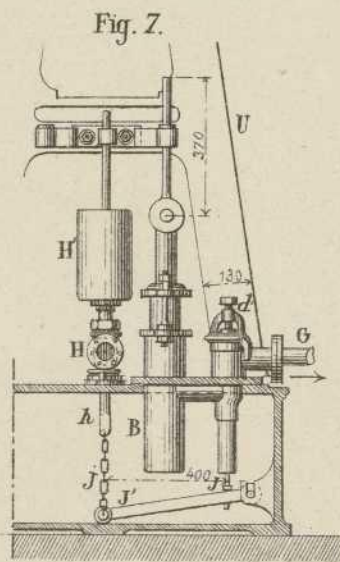
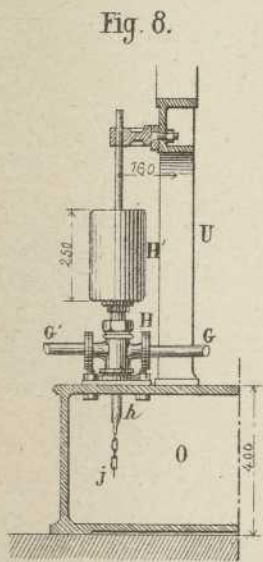
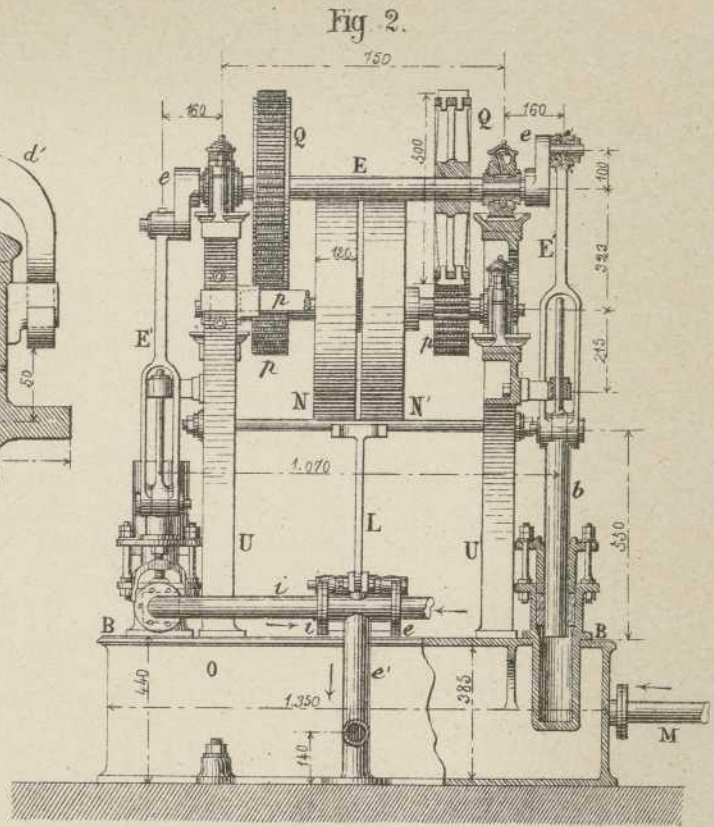
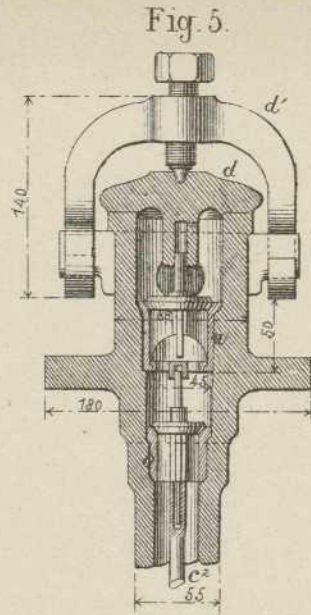
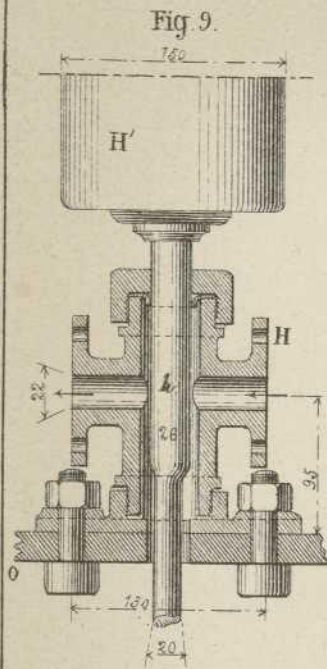


R









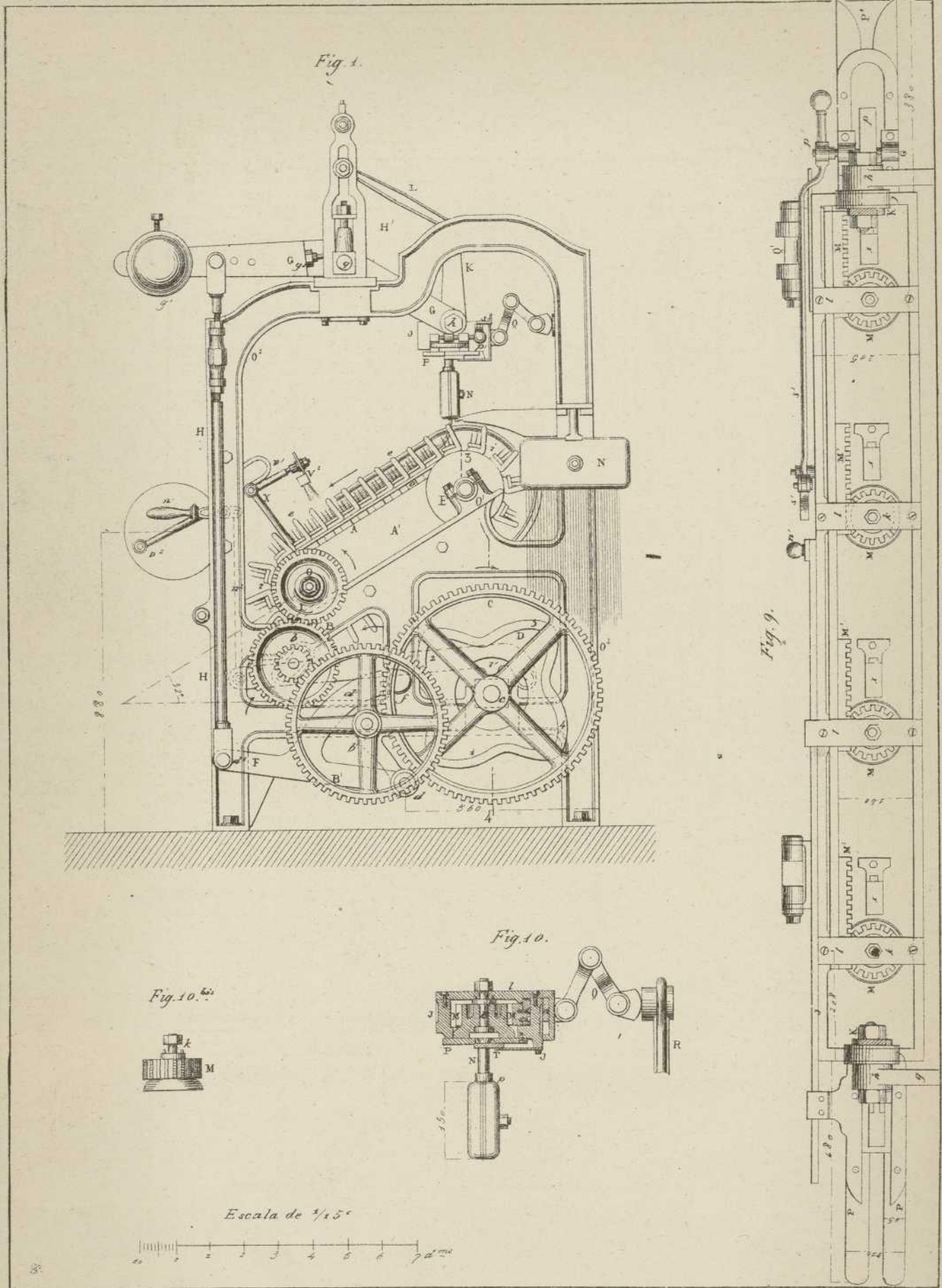
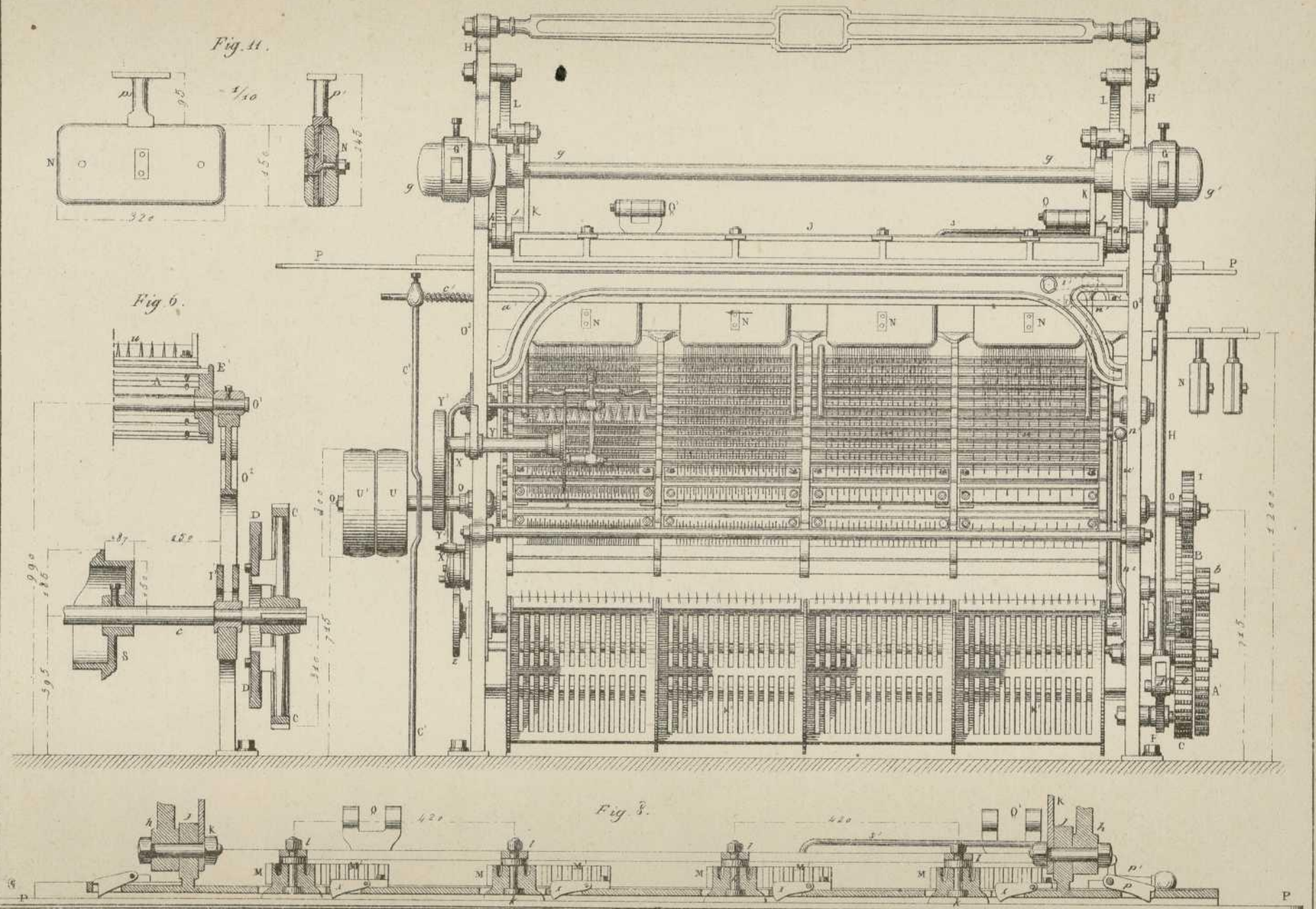
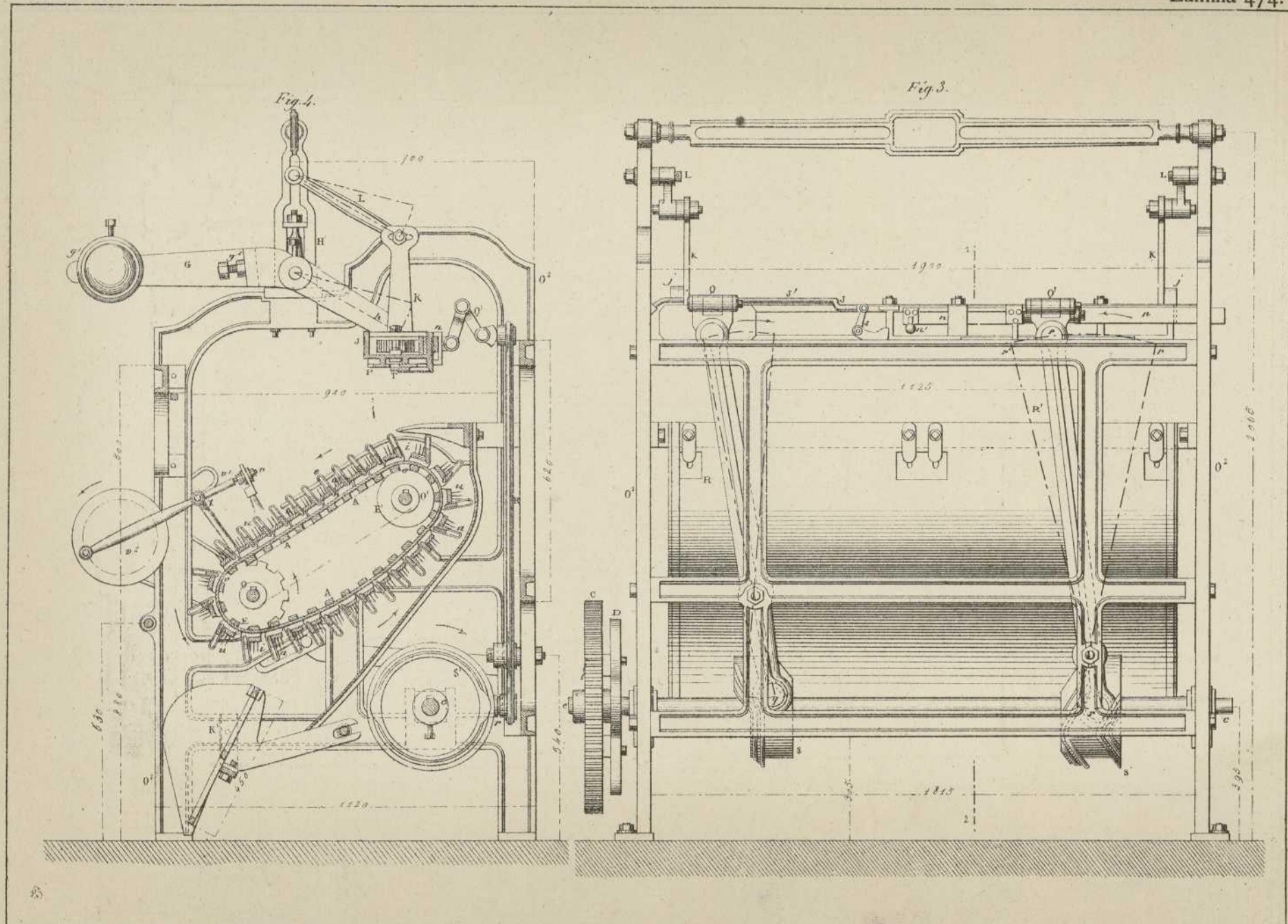
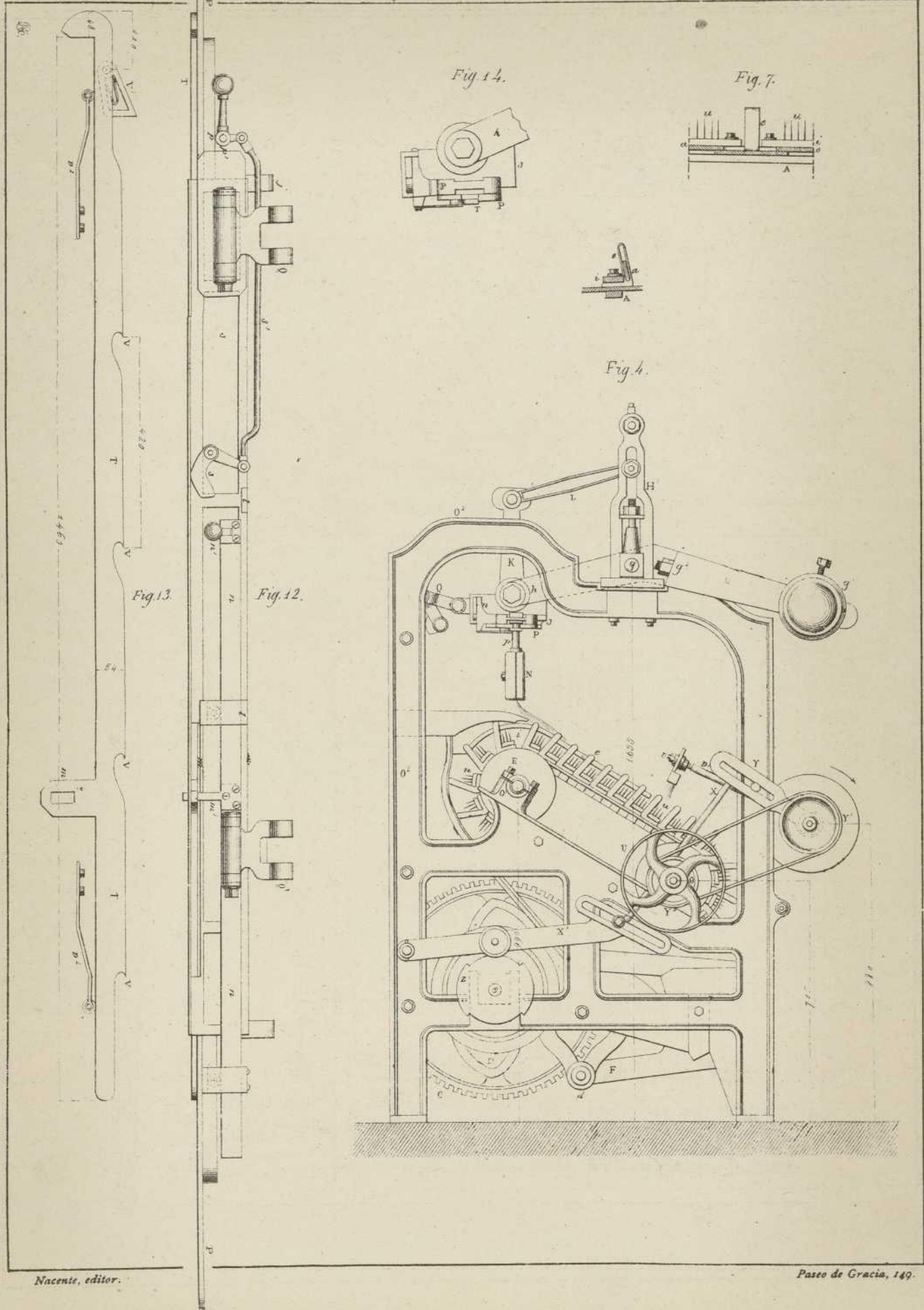
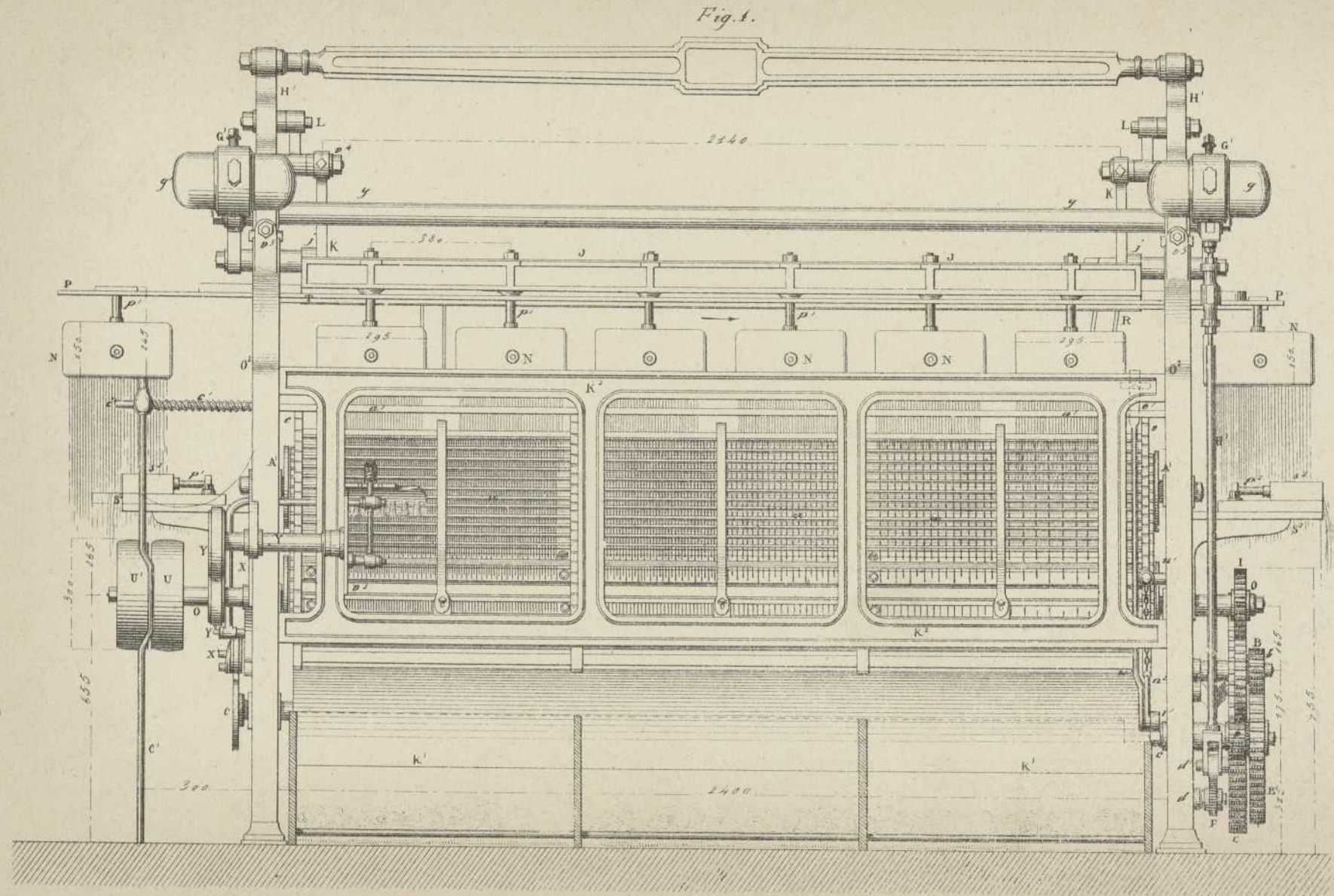


Fig. 2.

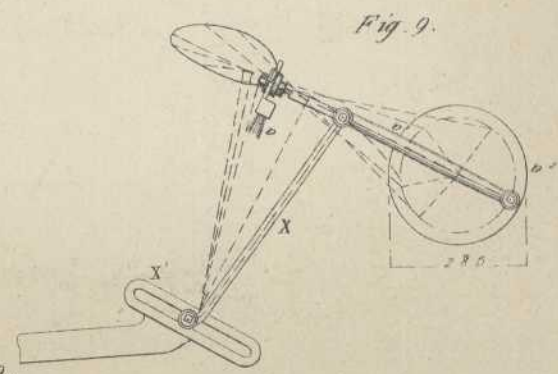
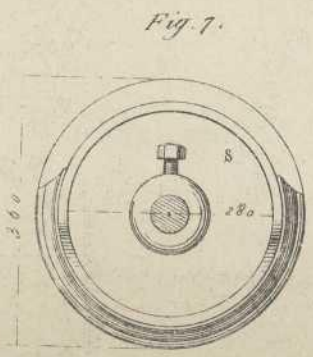
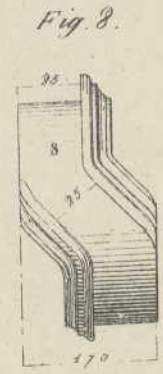
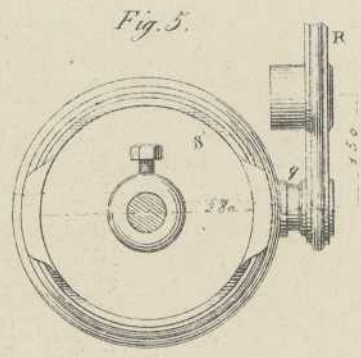
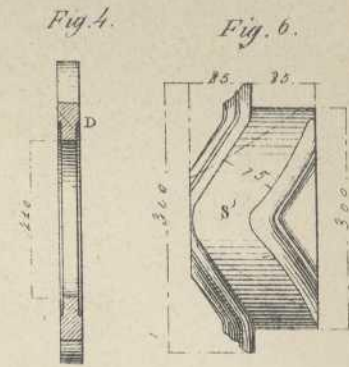
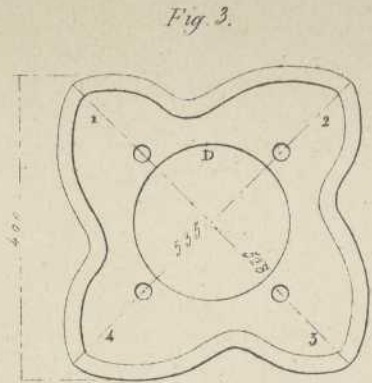
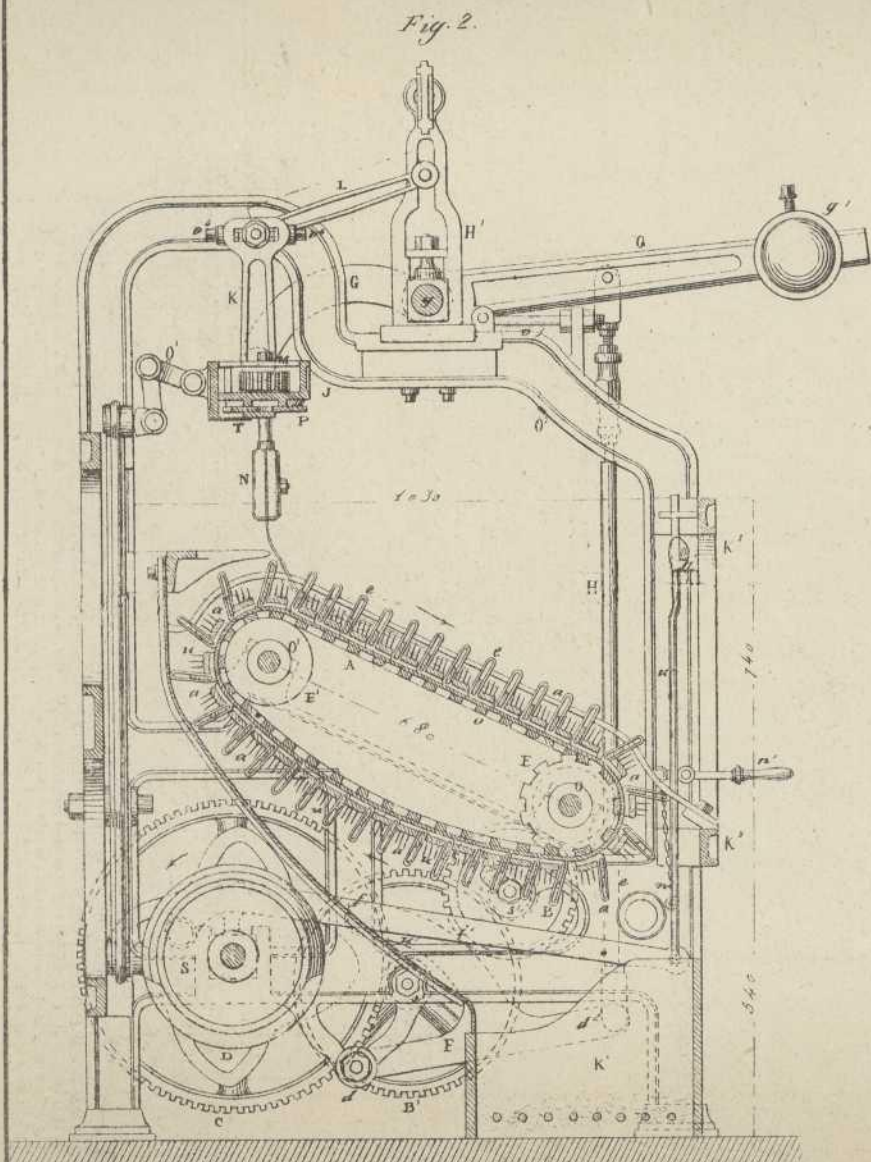




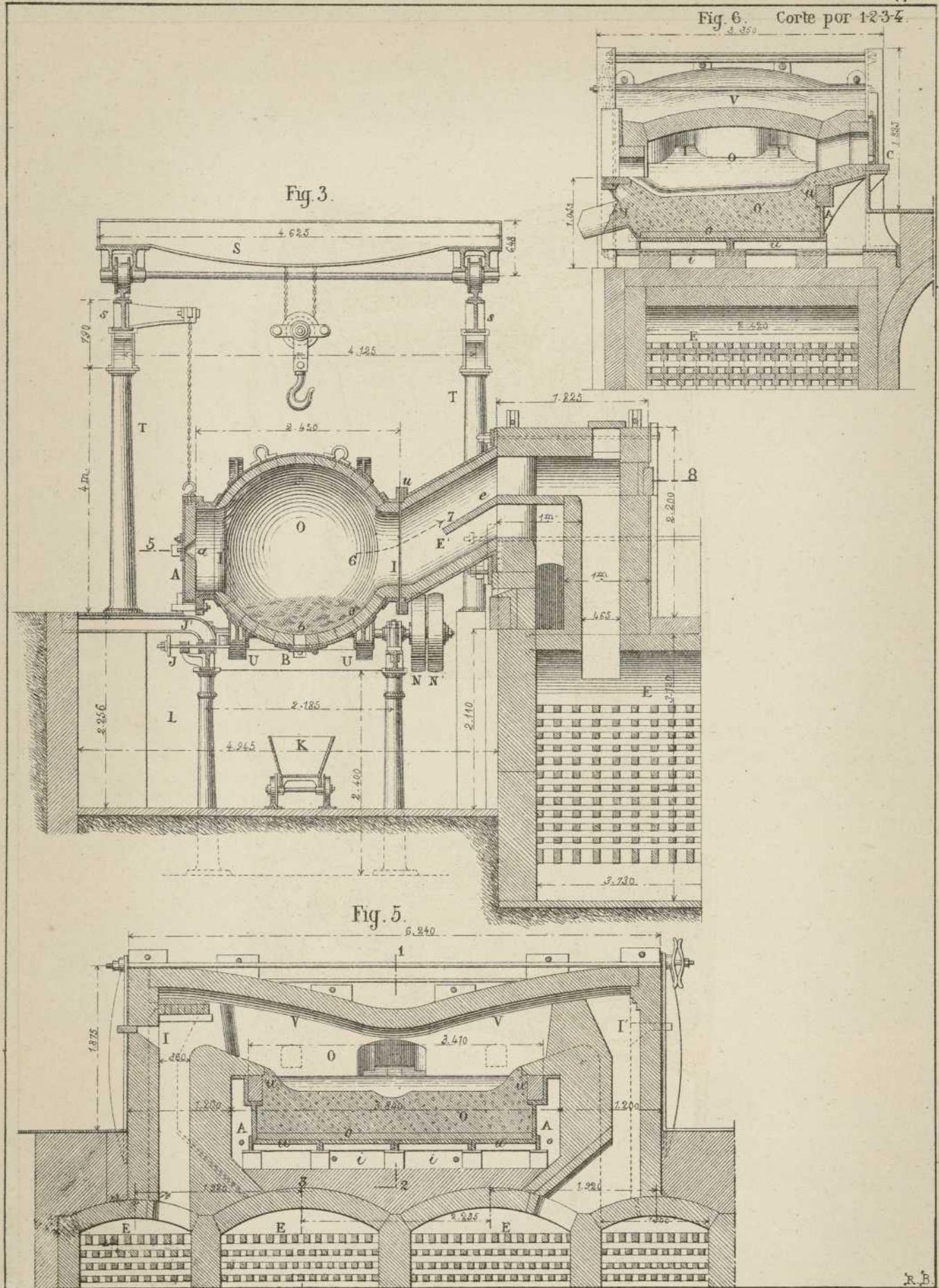


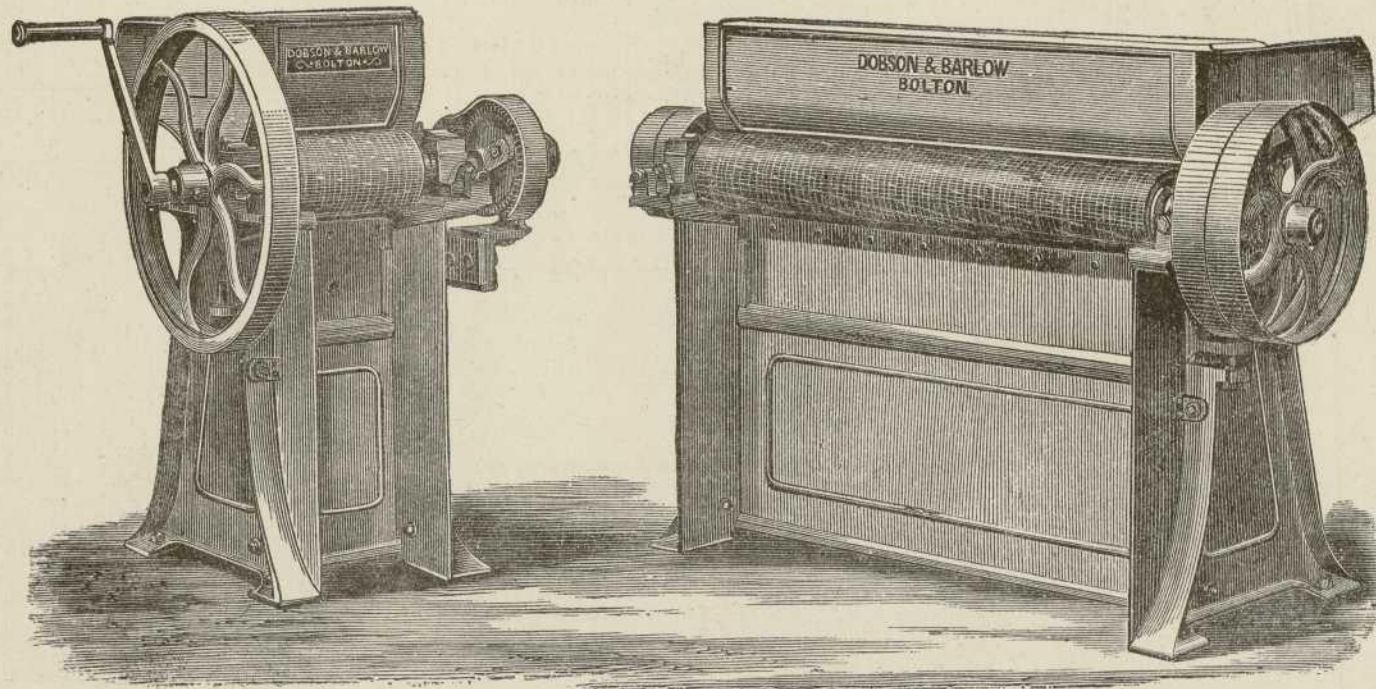


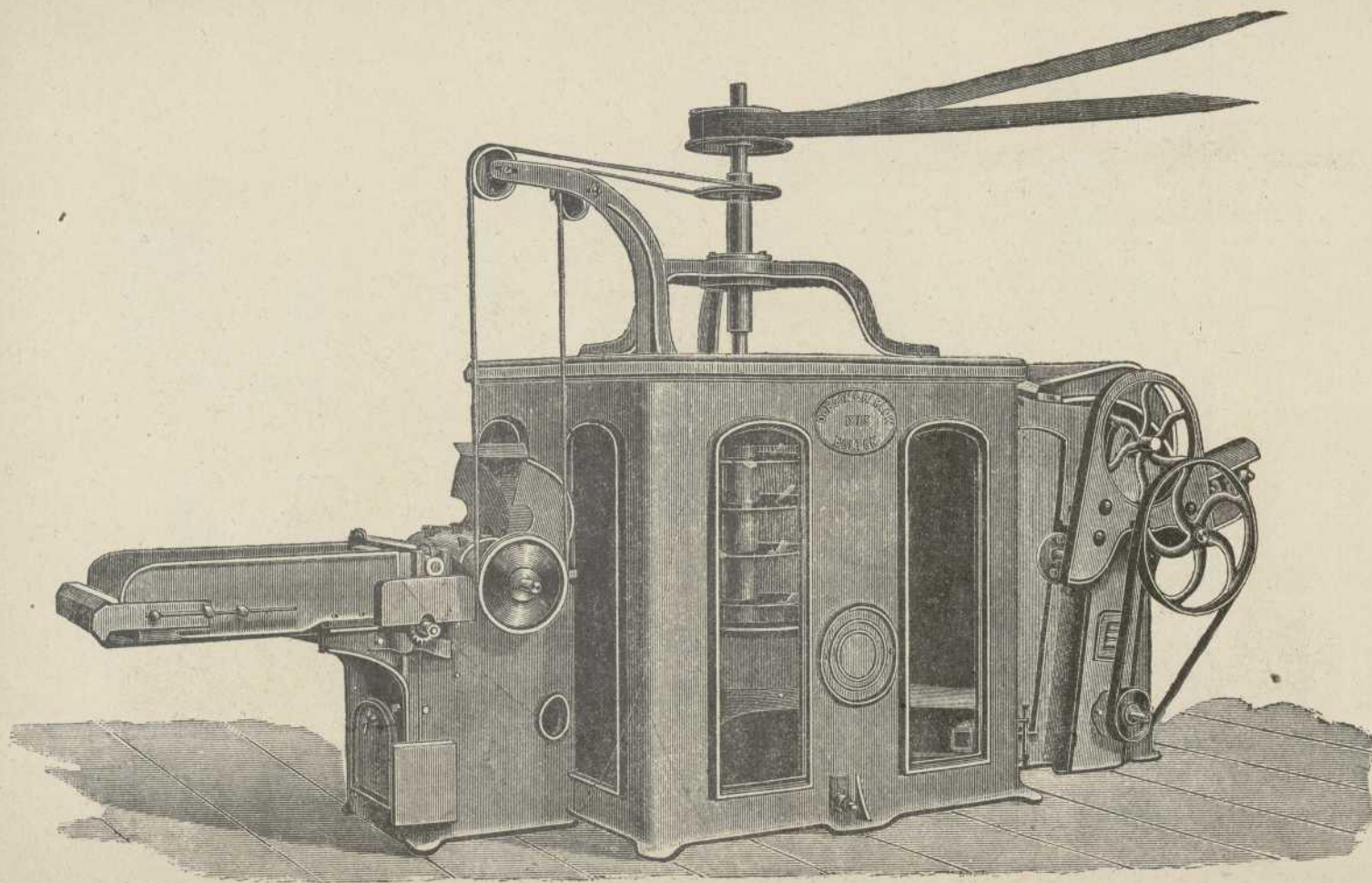
Escala de 1/25 por las Fig 1 y 2.

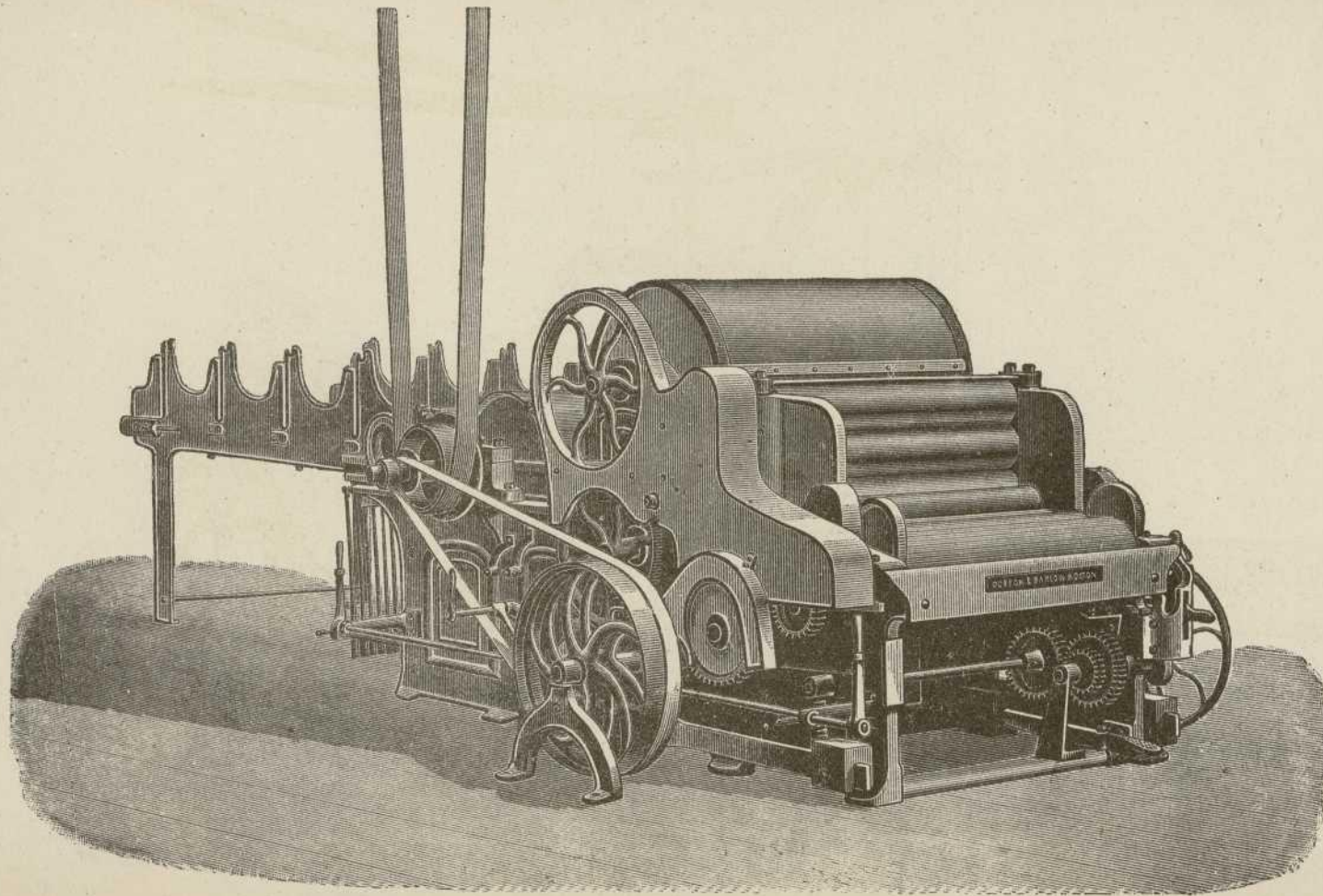


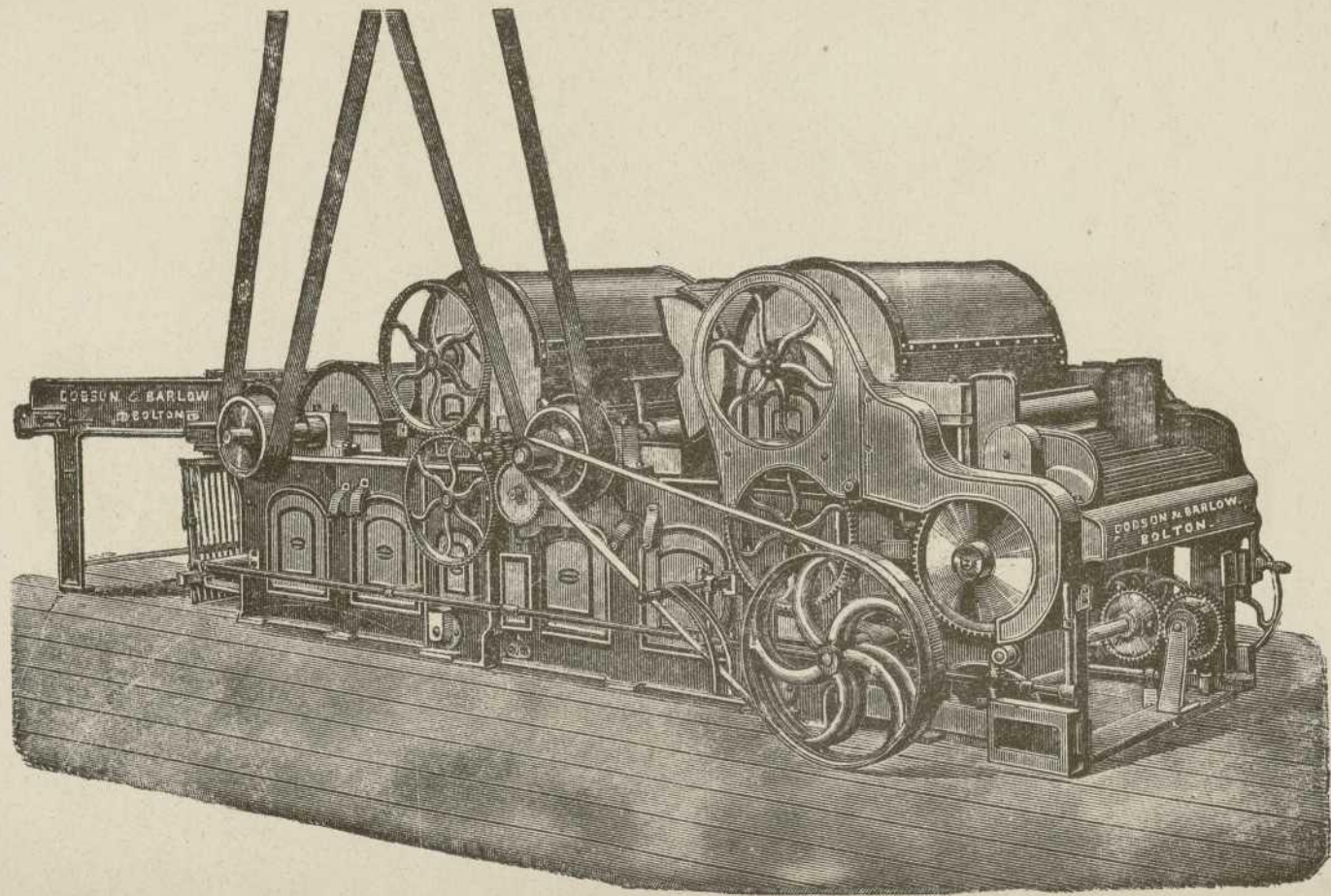
Escala de 1/15 por las Fig 1, 2 y 9.

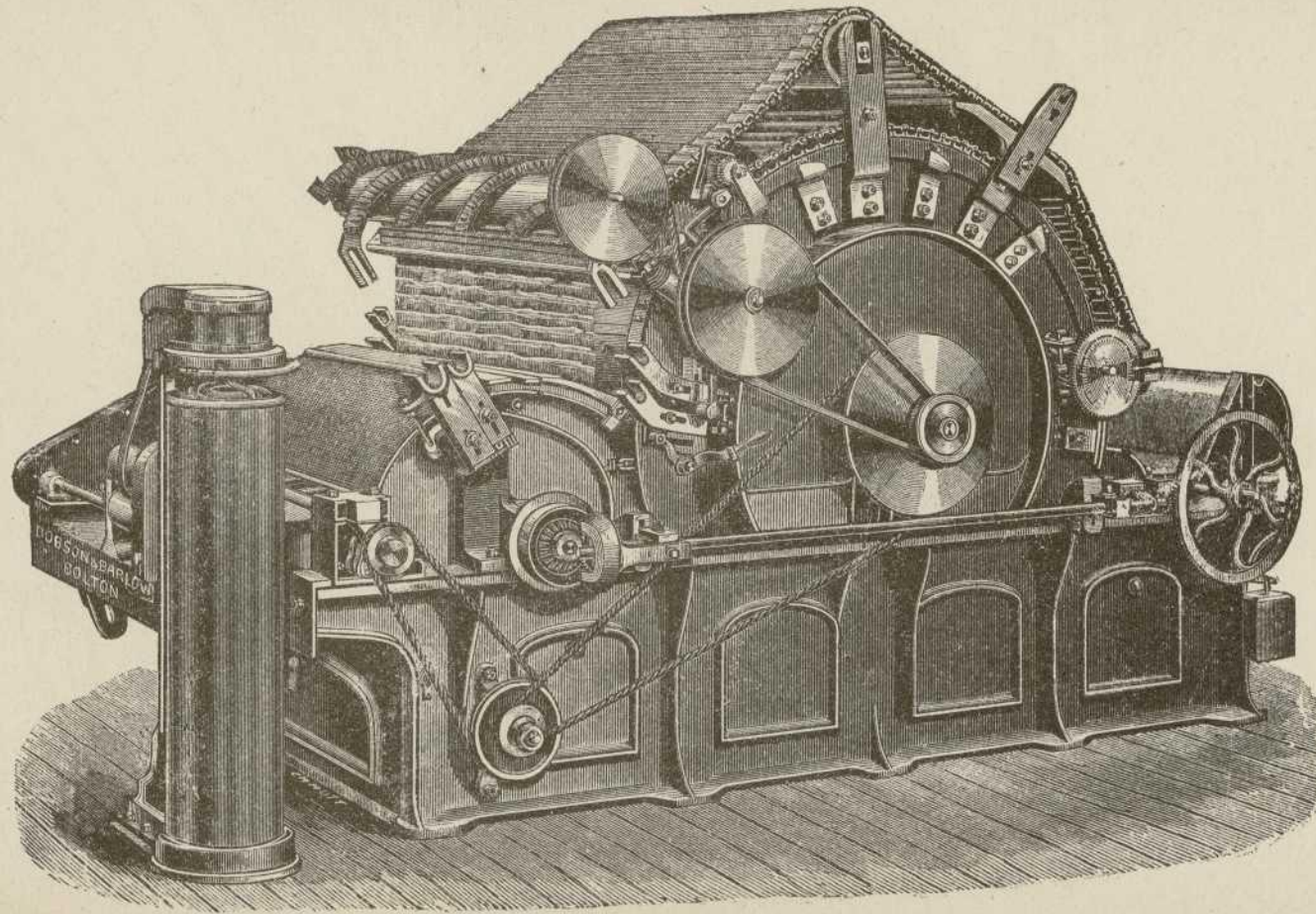


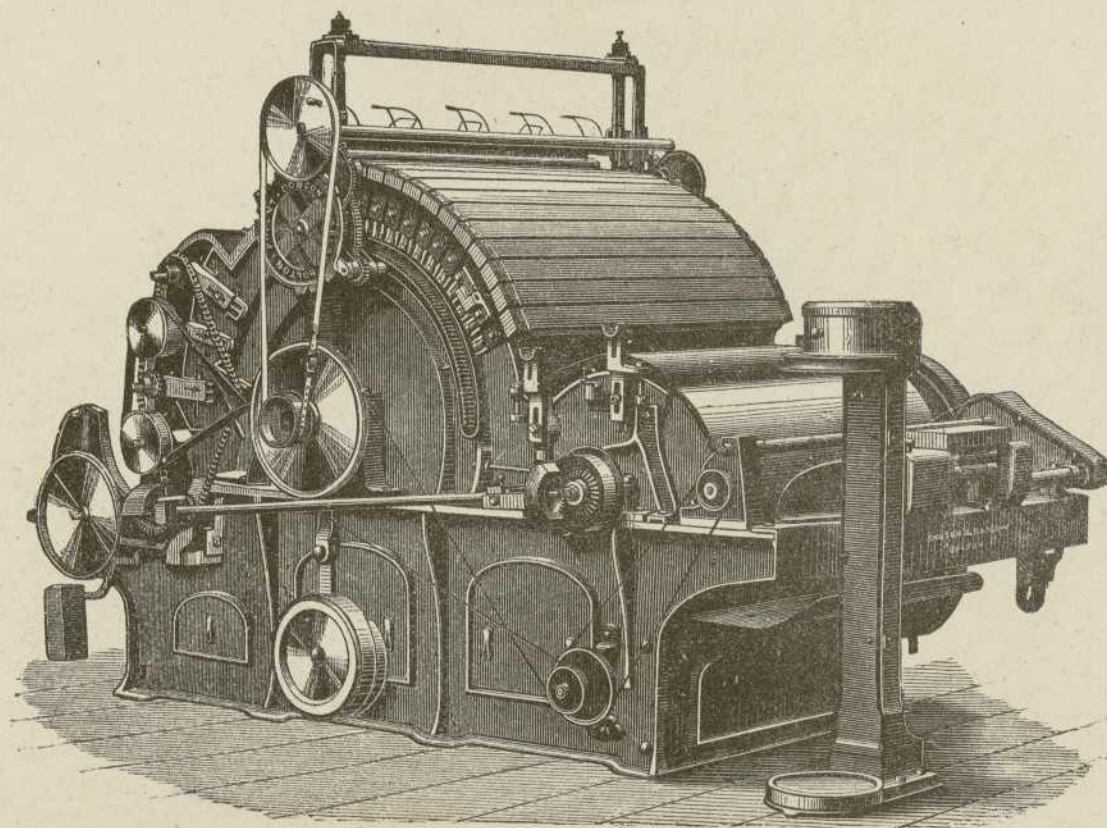


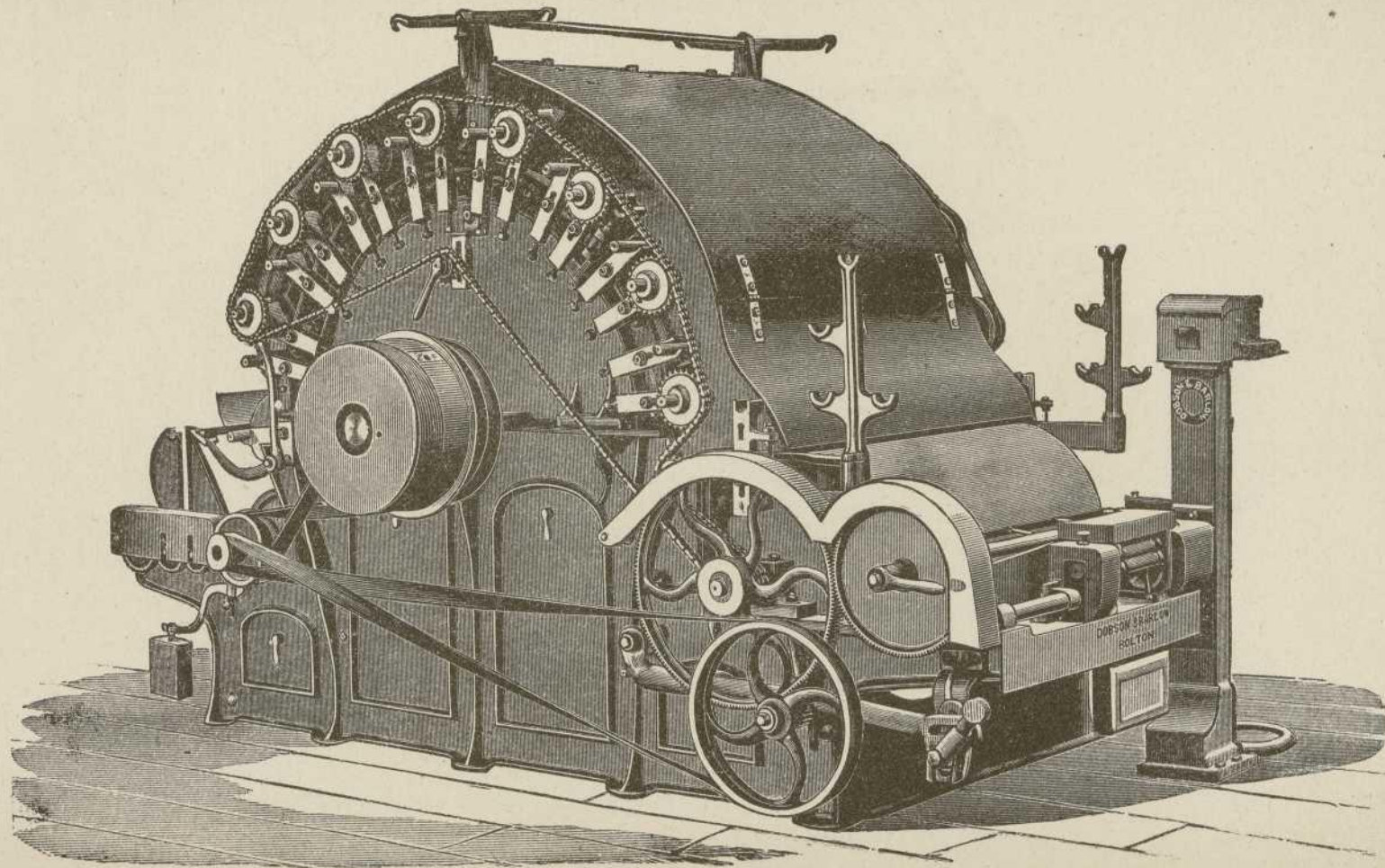


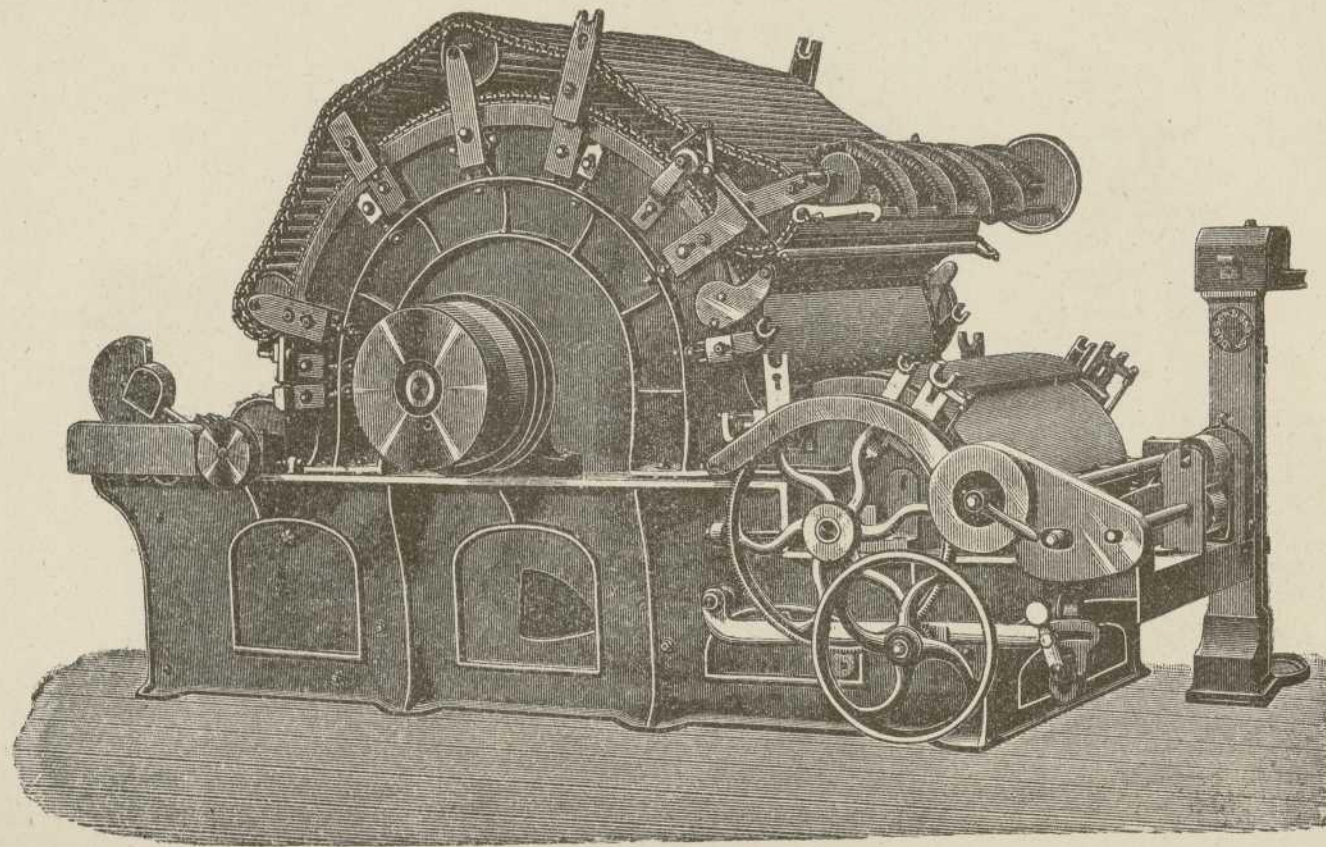


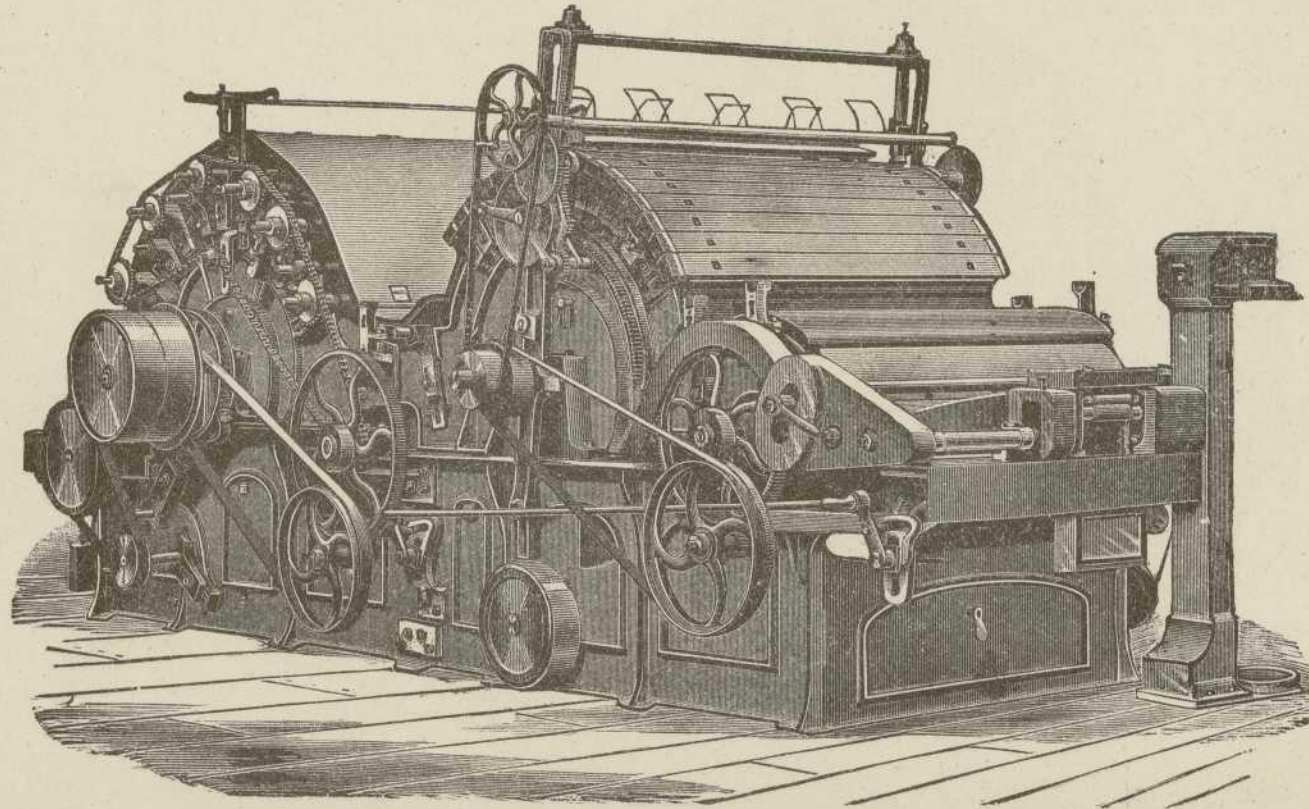


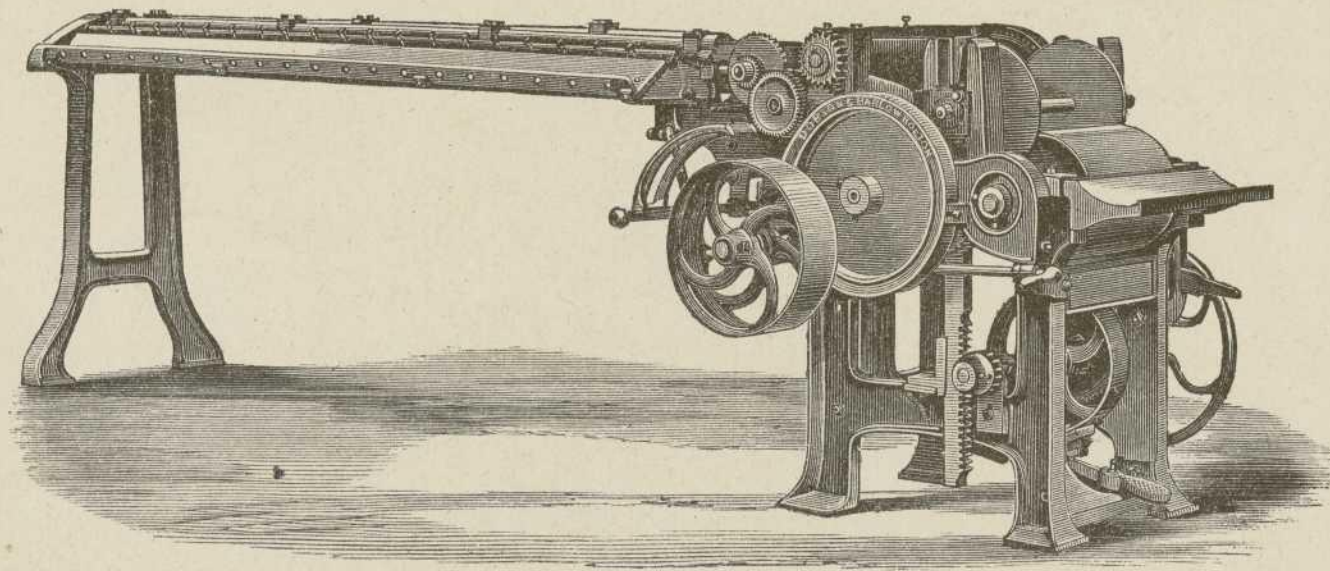


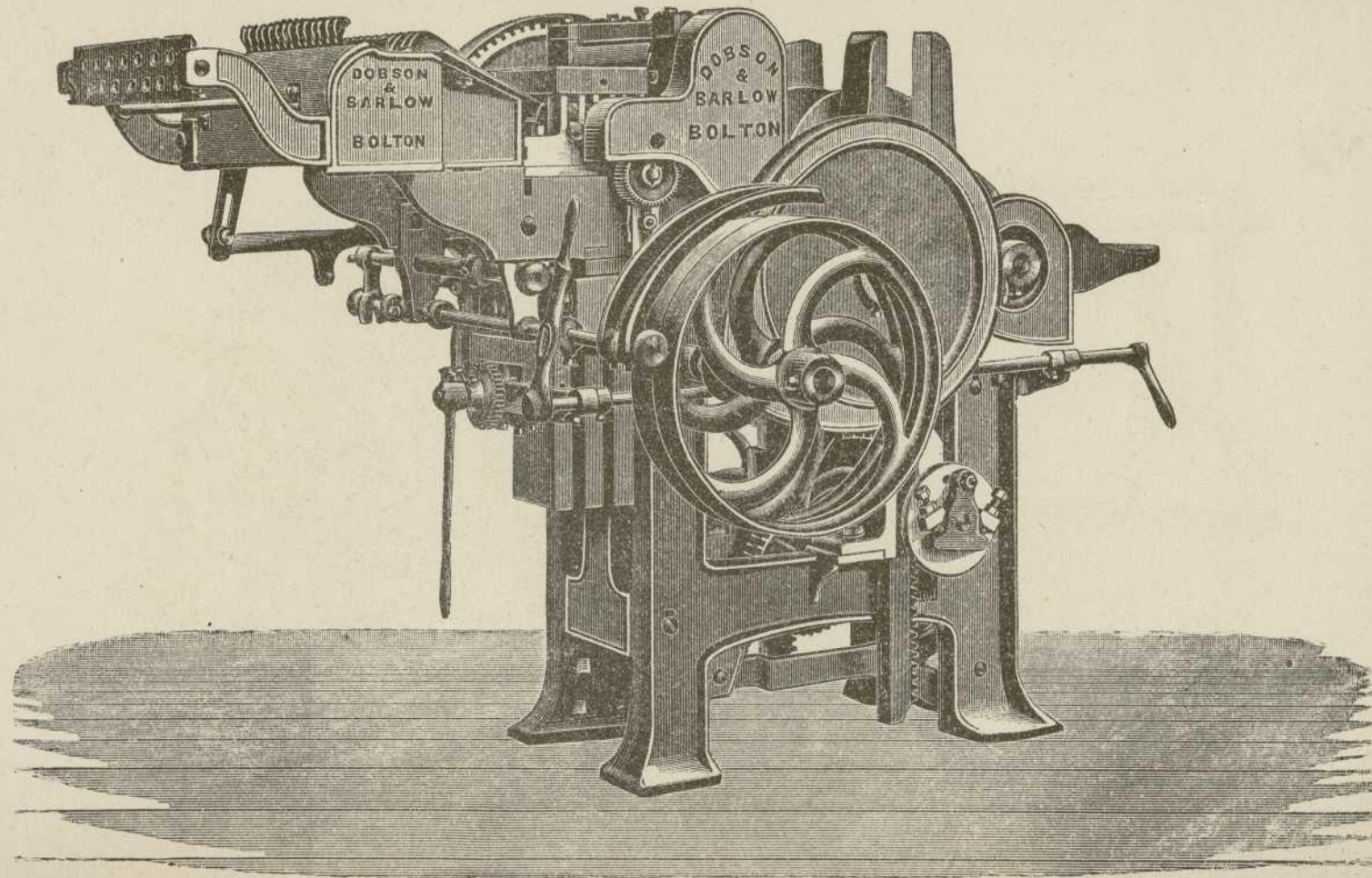


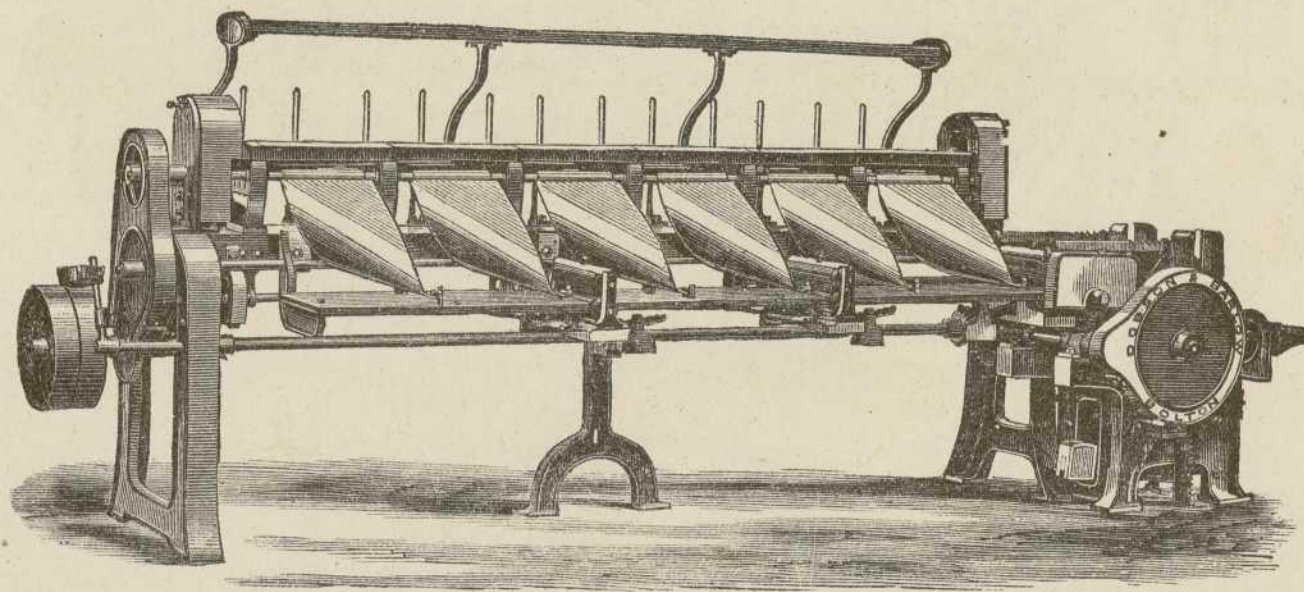


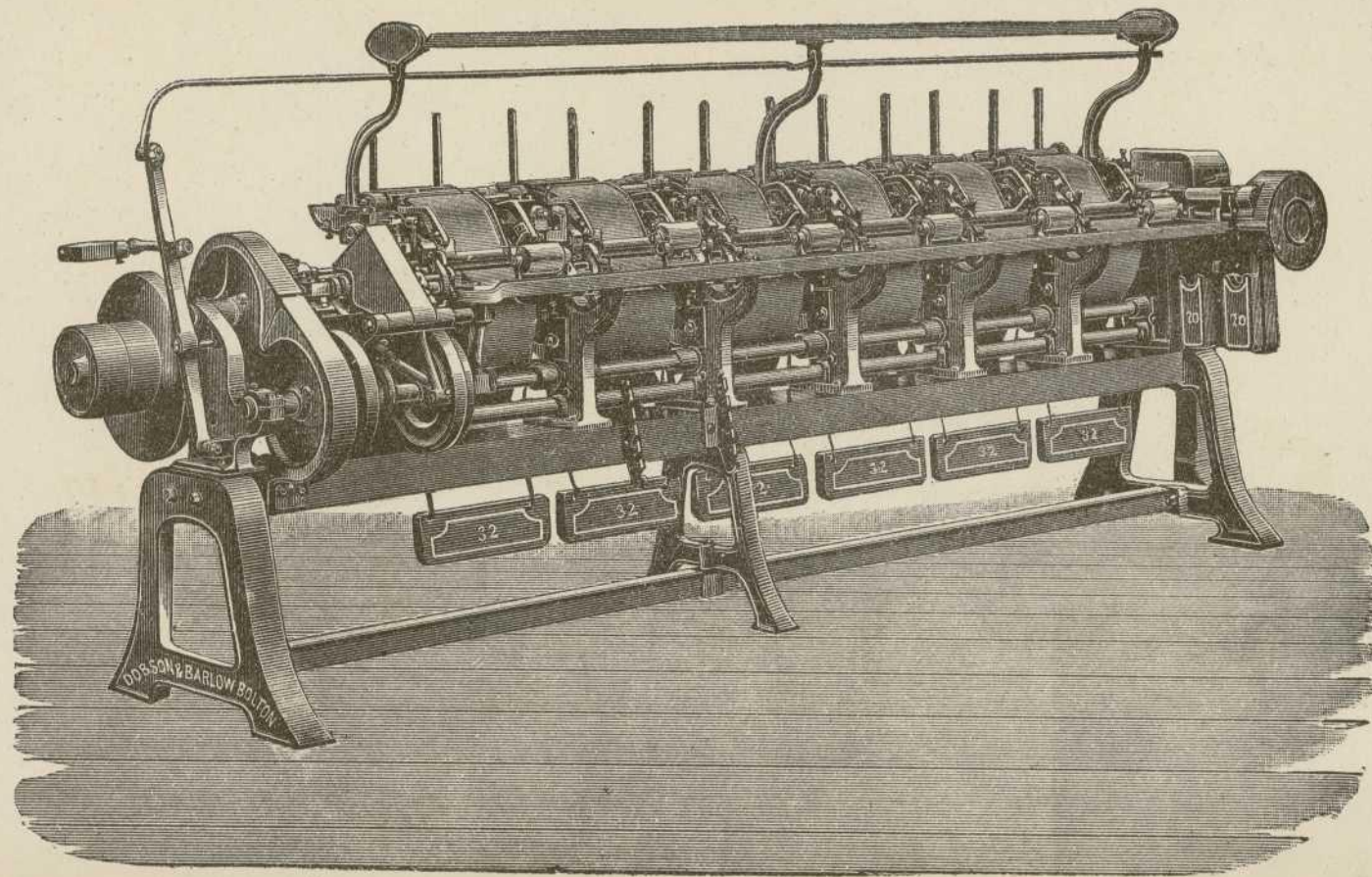


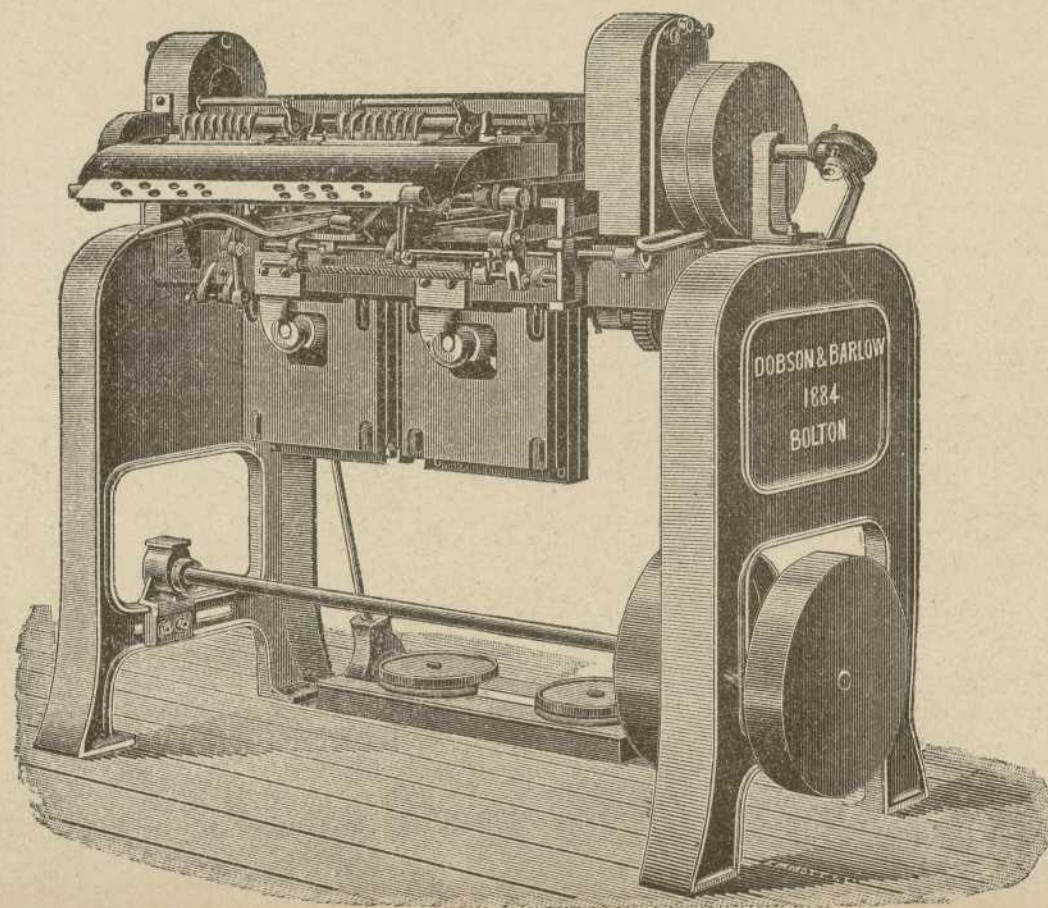


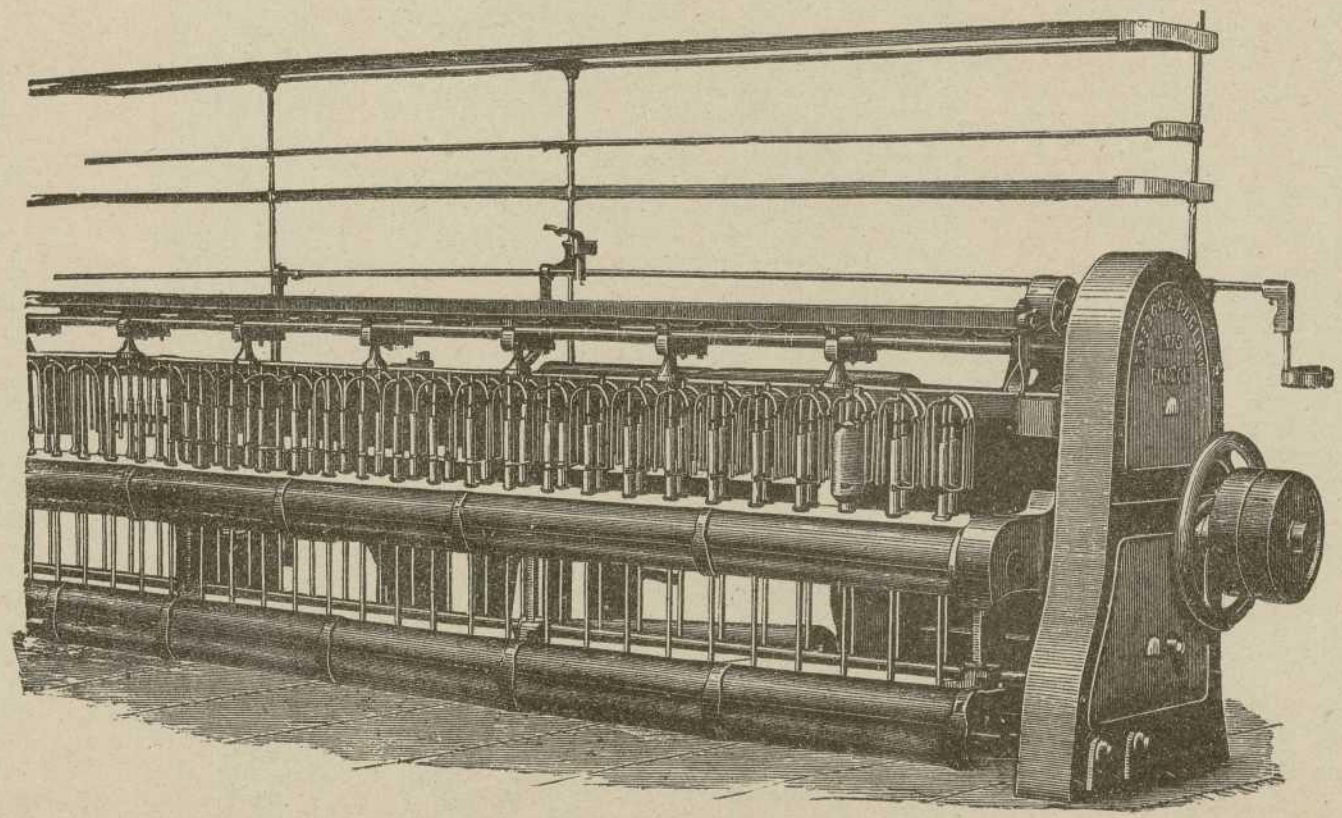


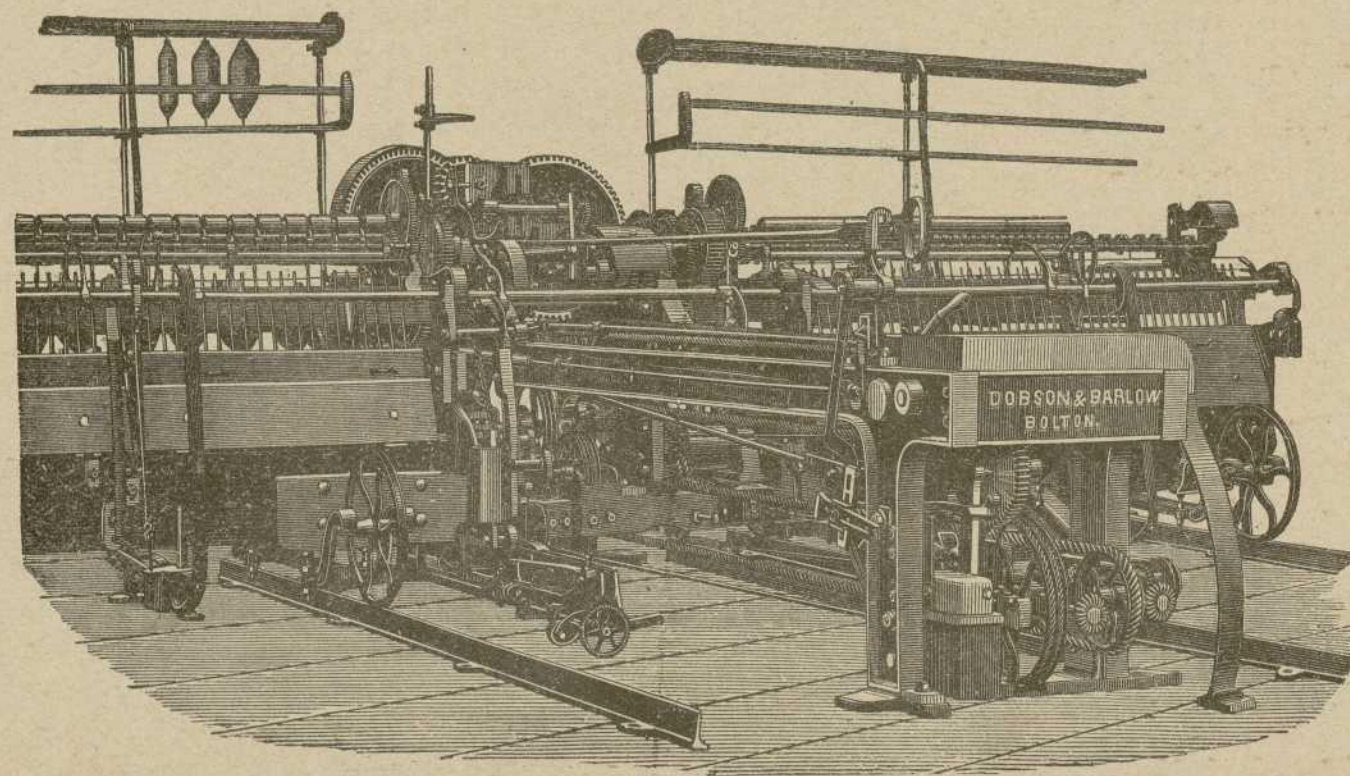


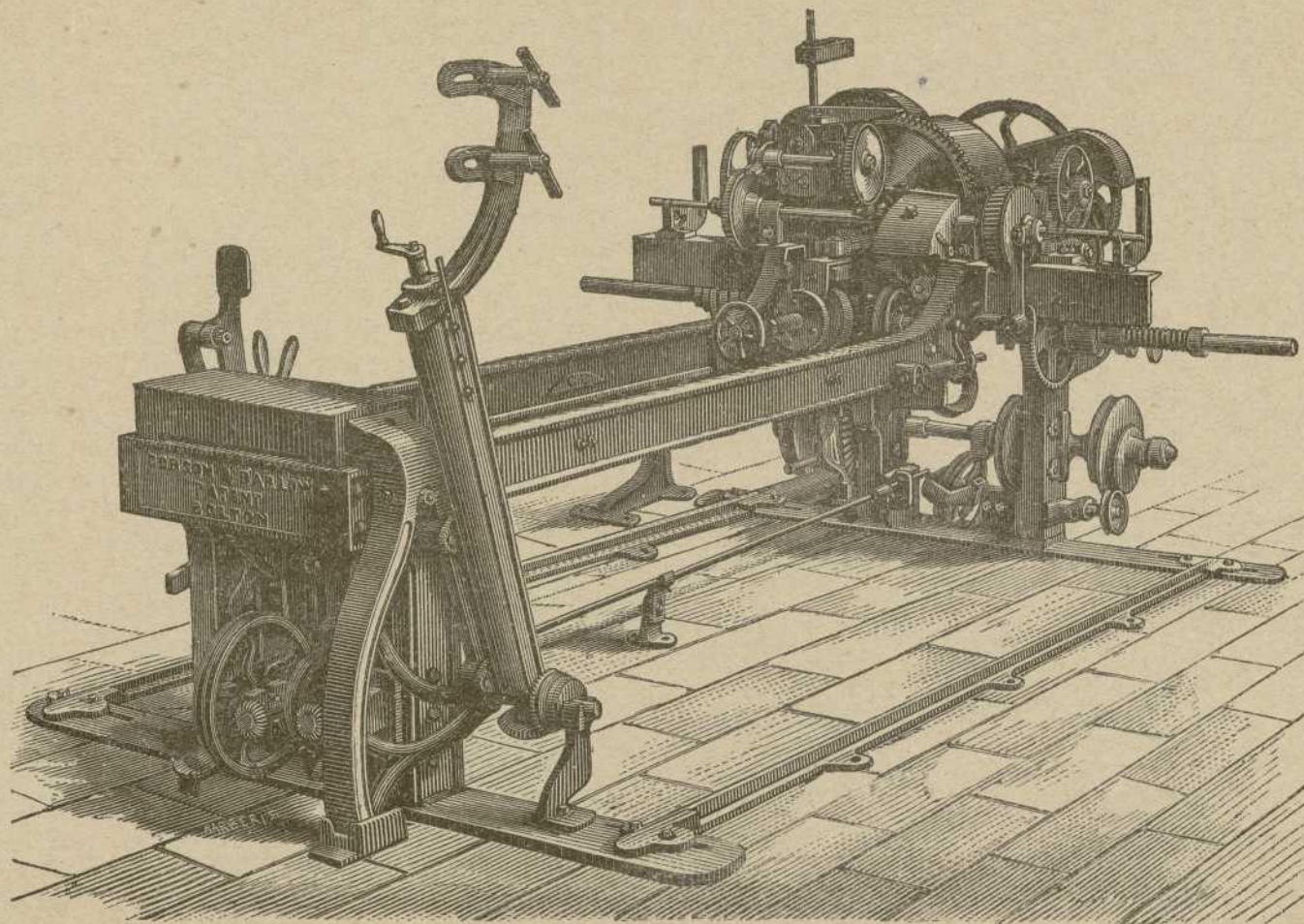


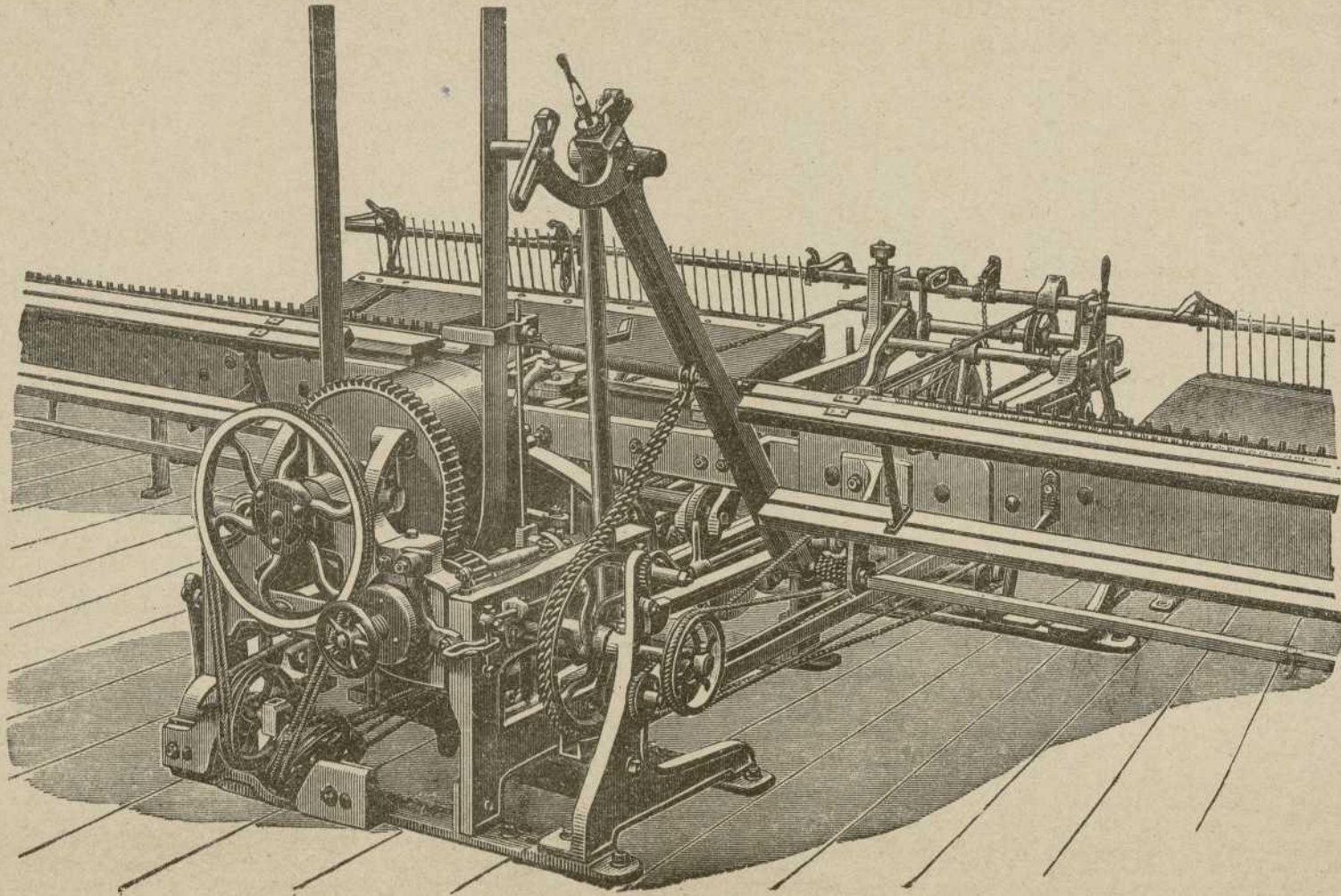


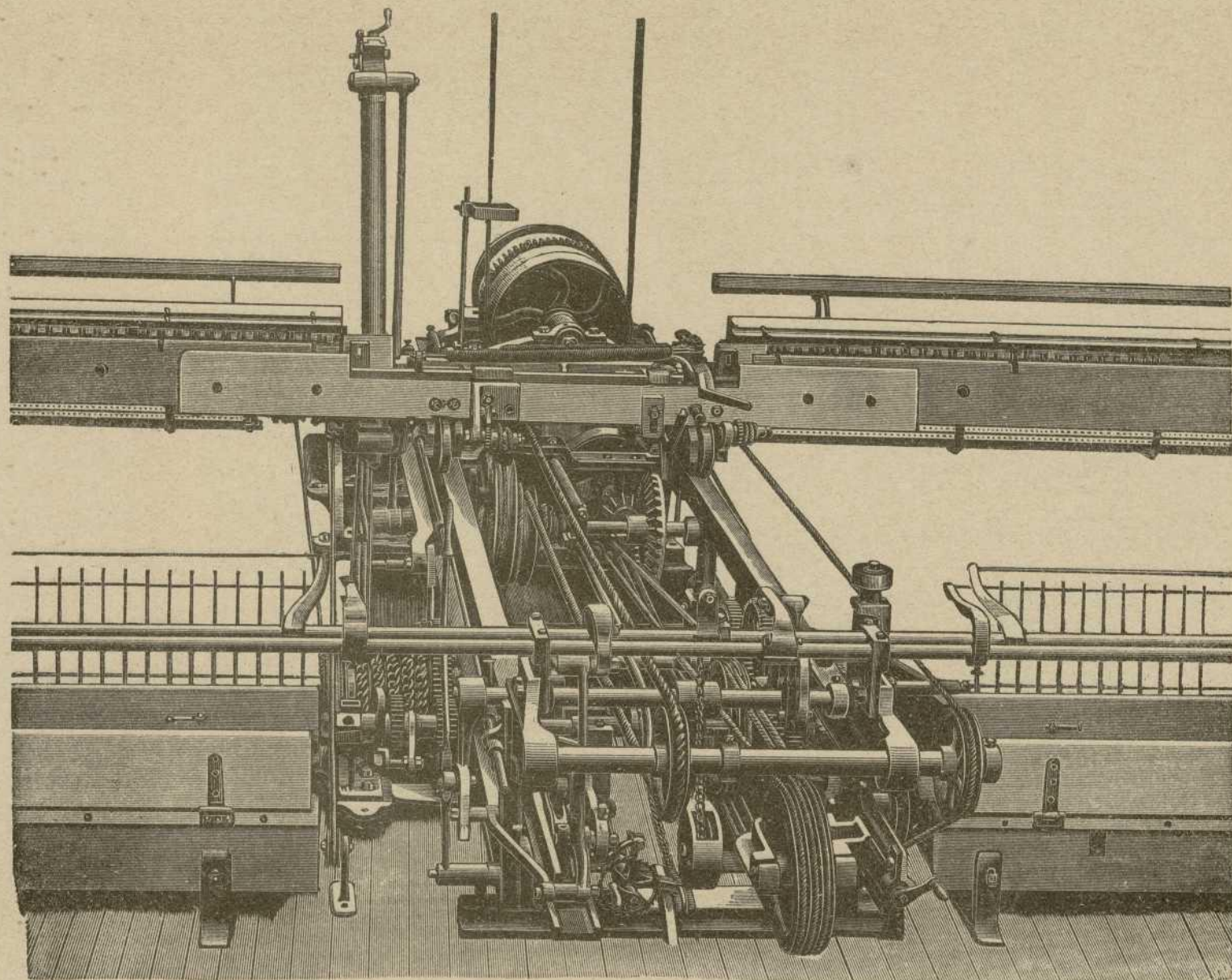


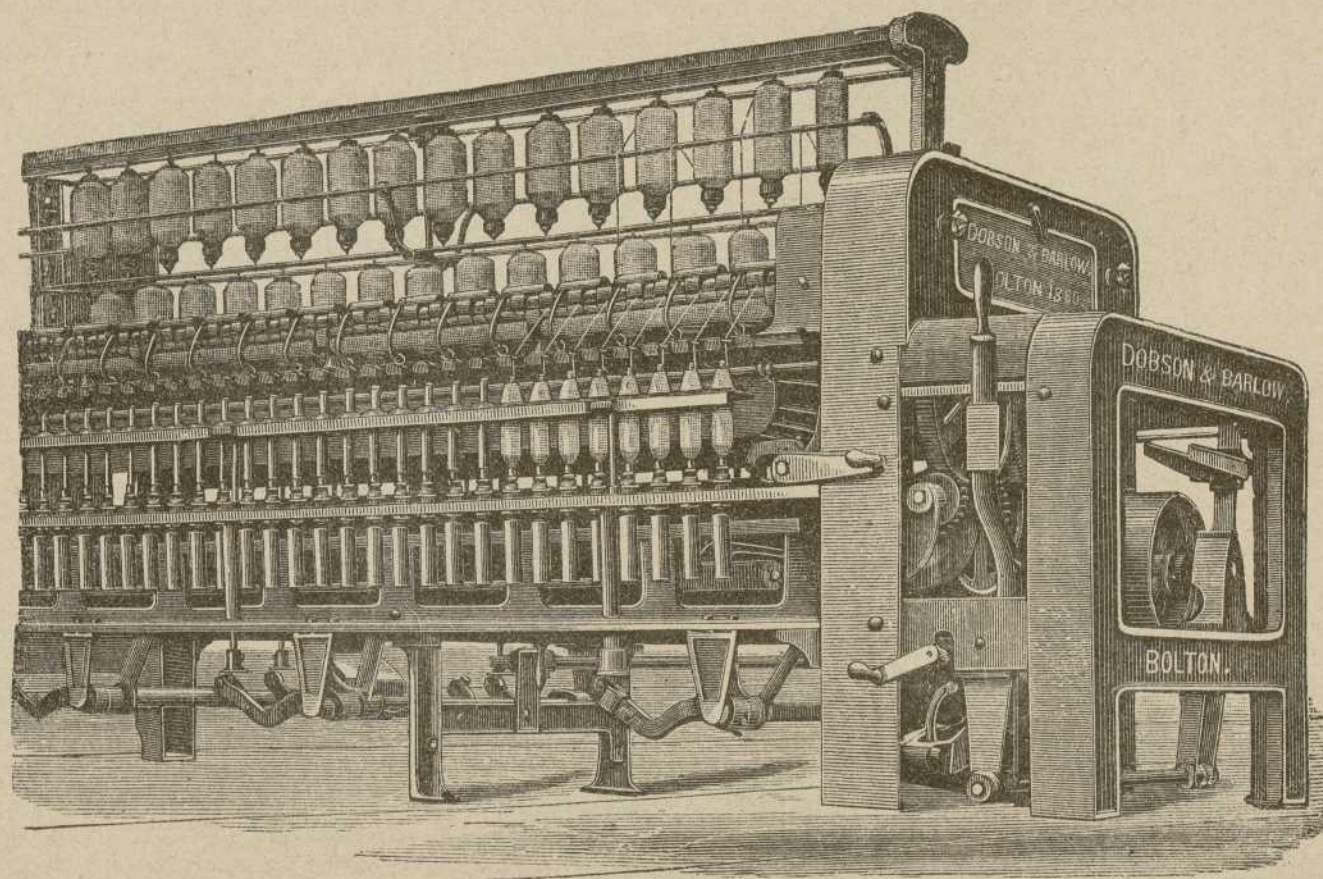


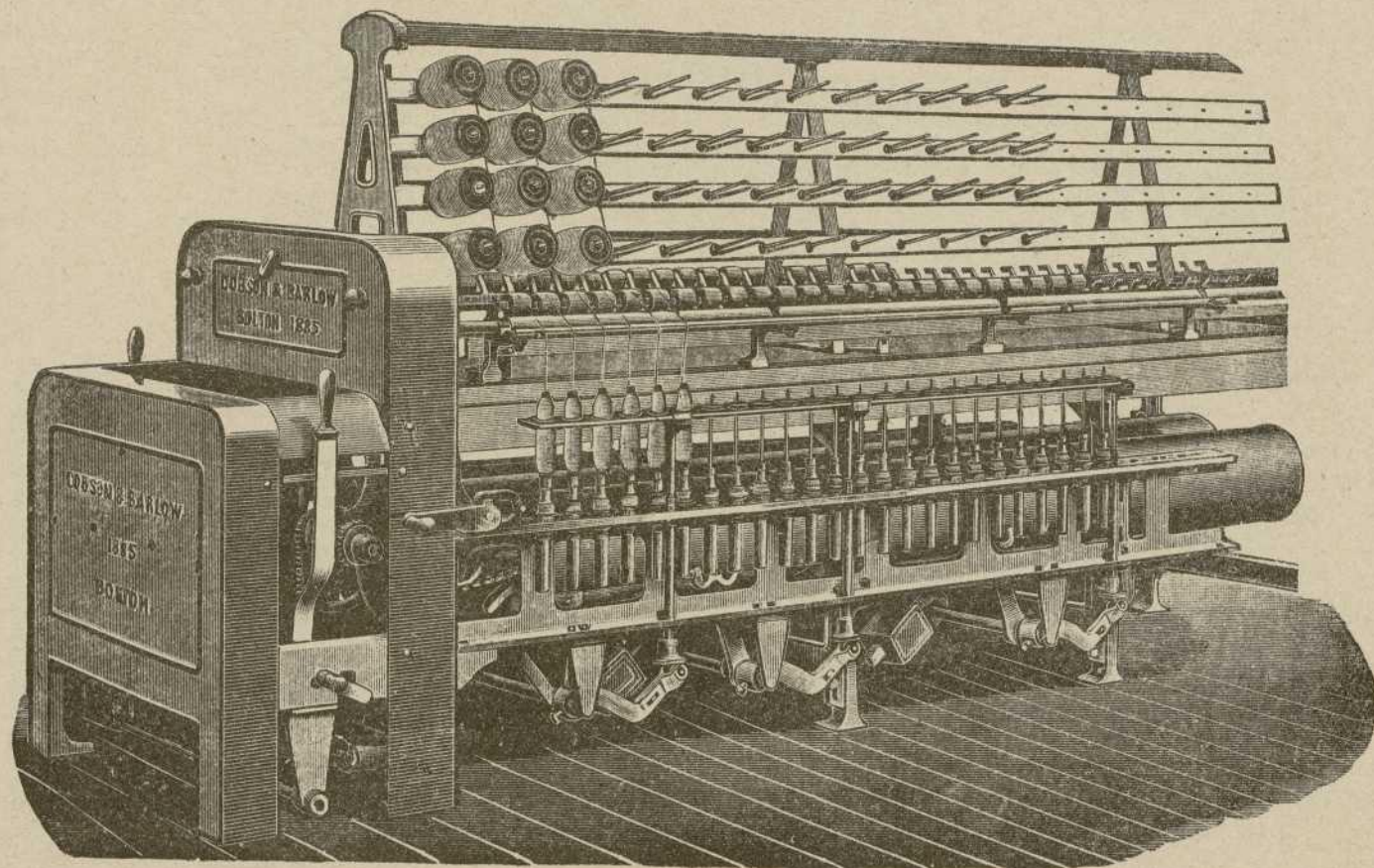


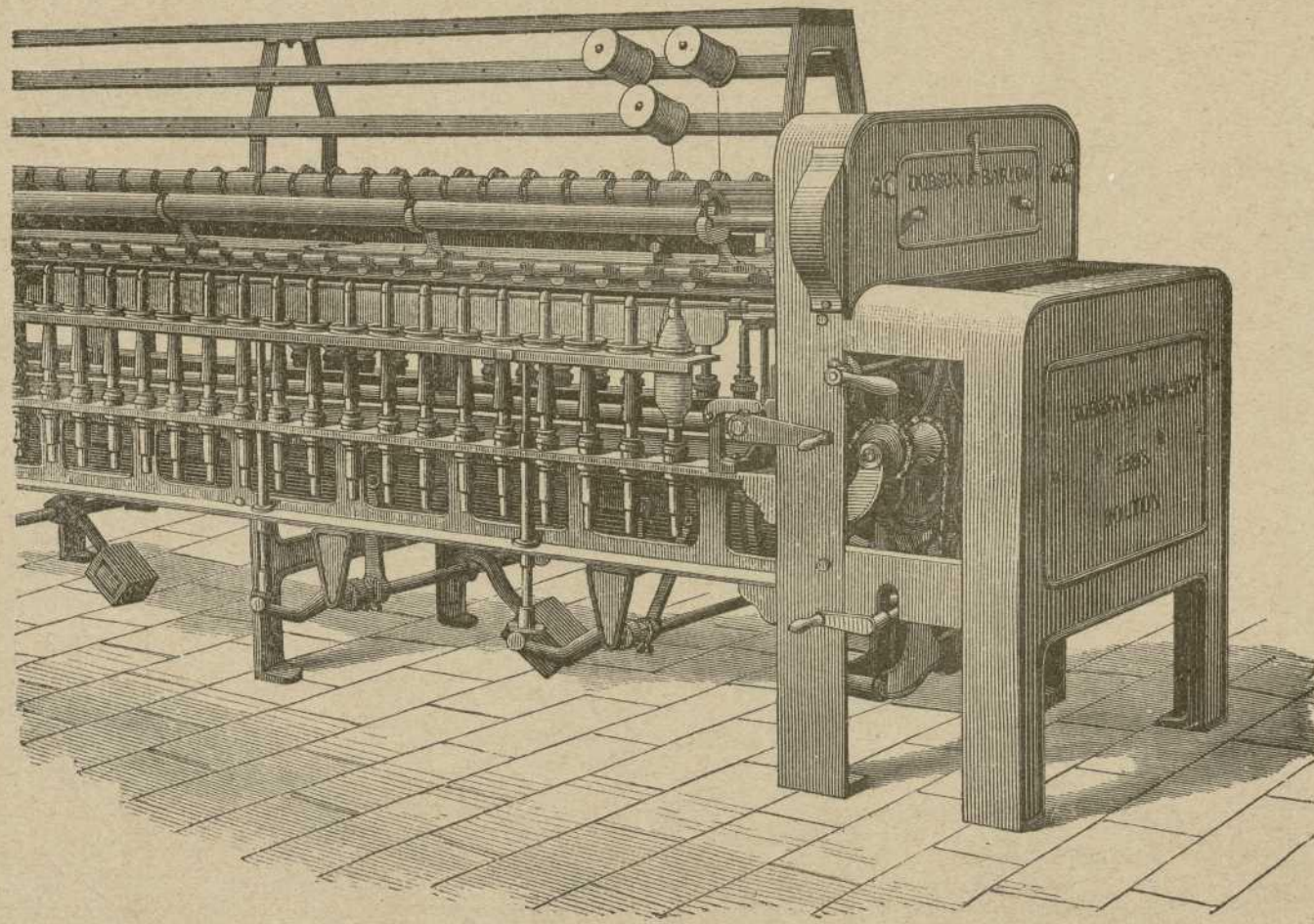


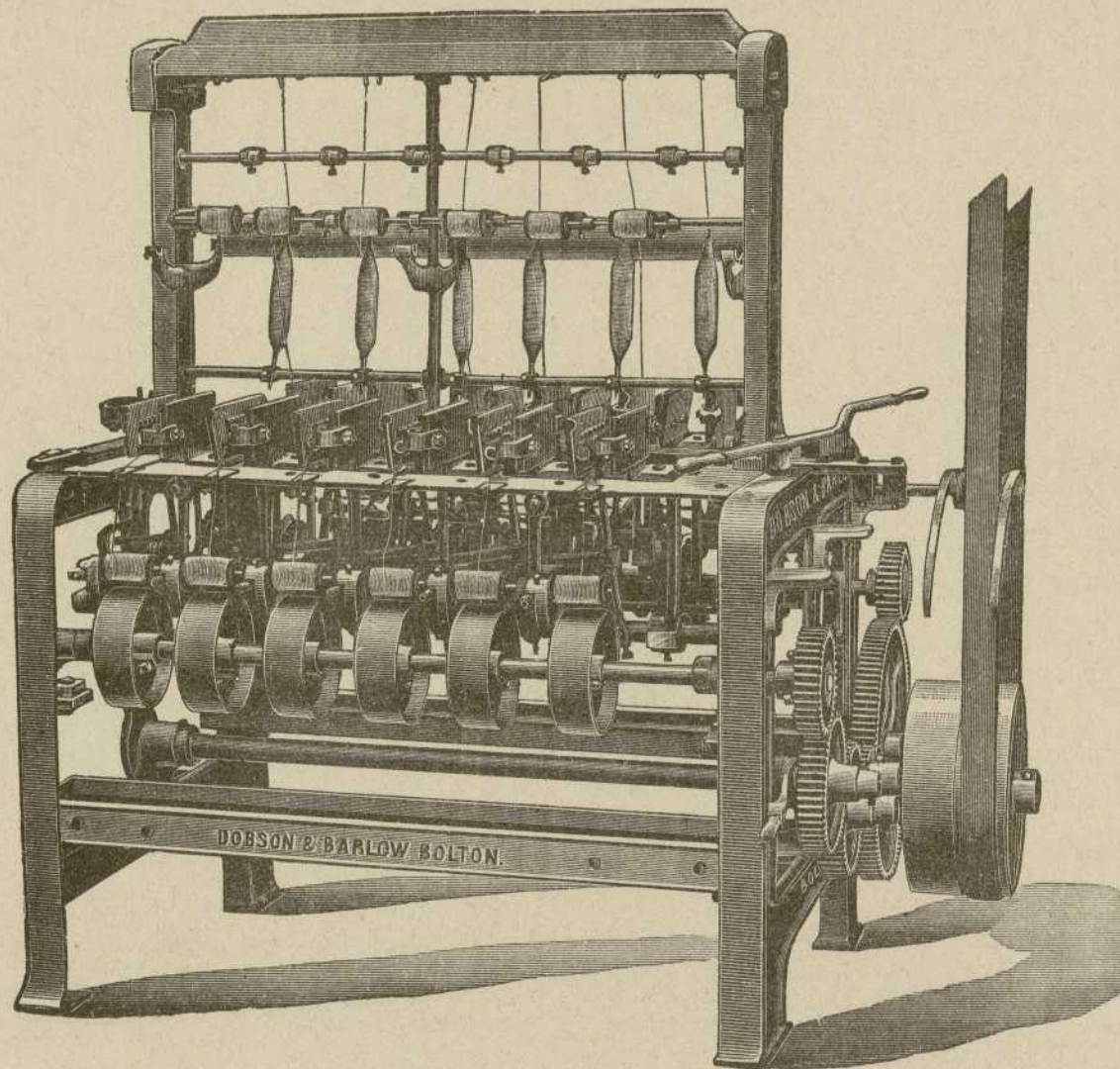


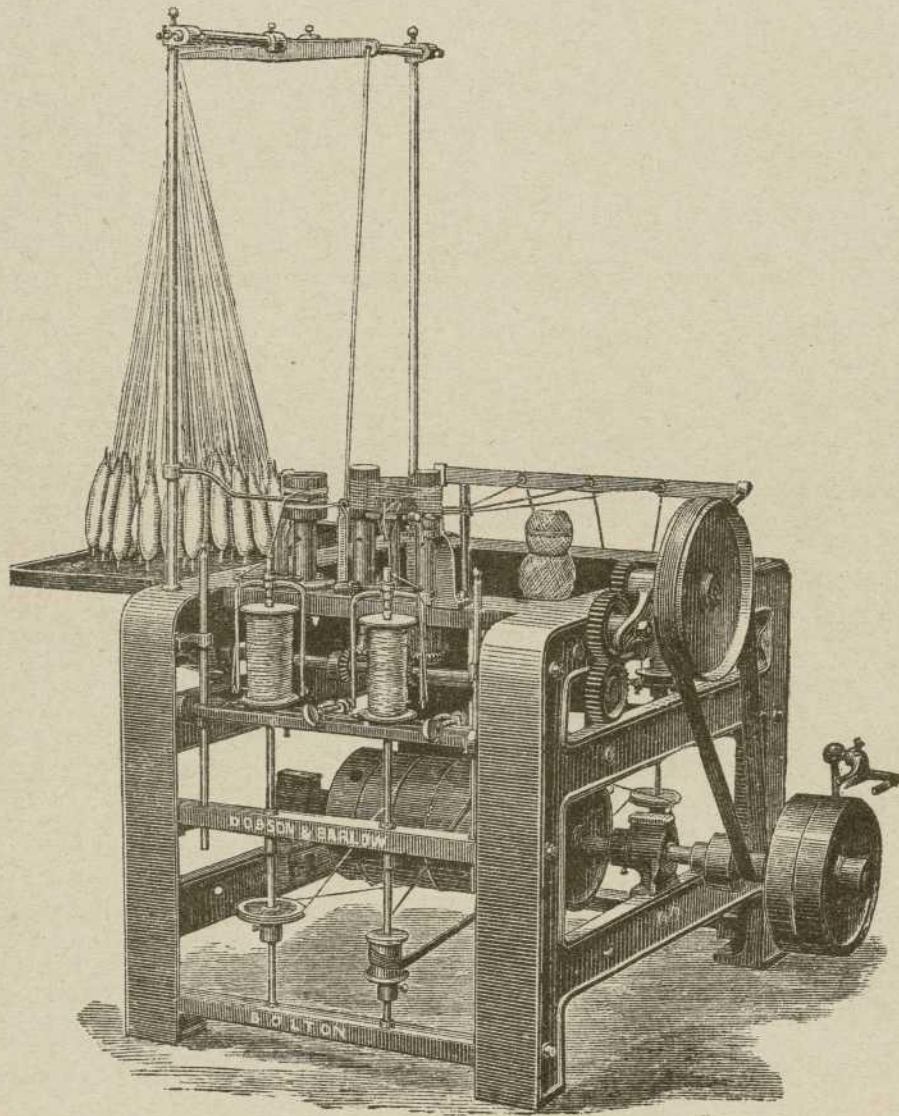


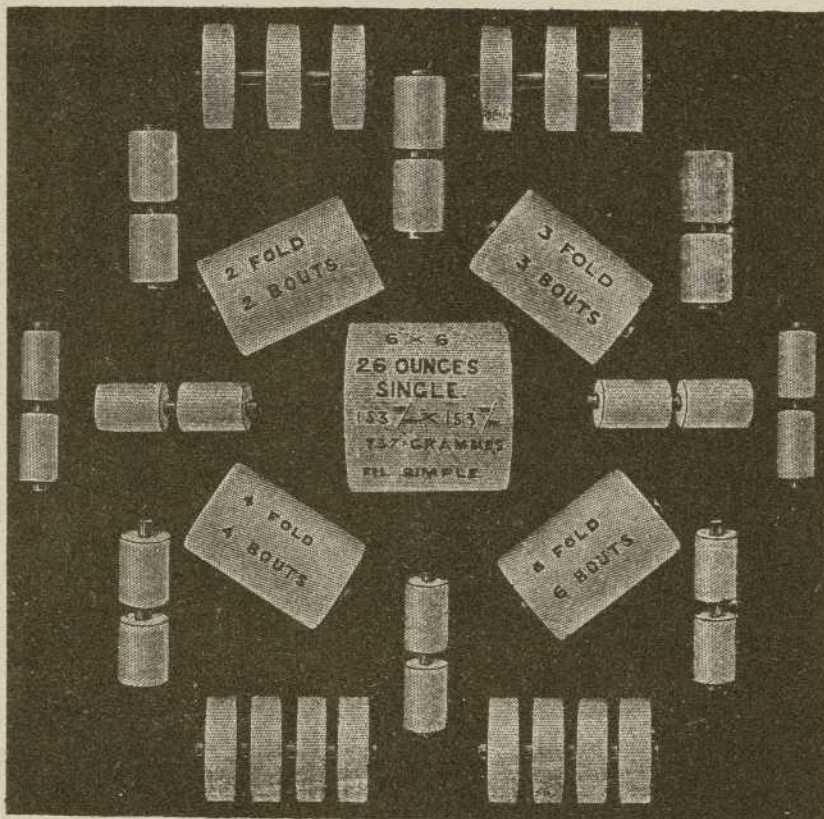












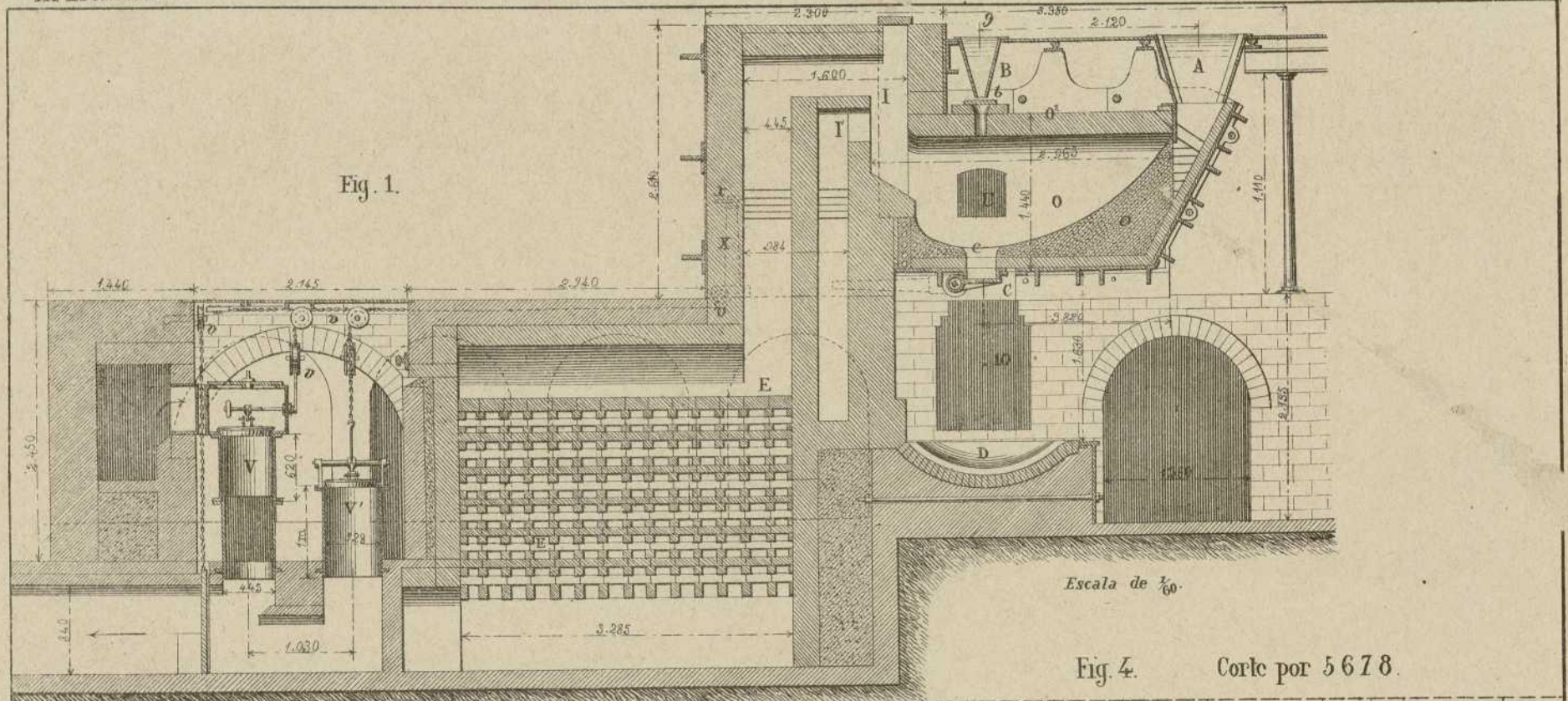


Fig. 1.

Escala de $\frac{1}{60}$.

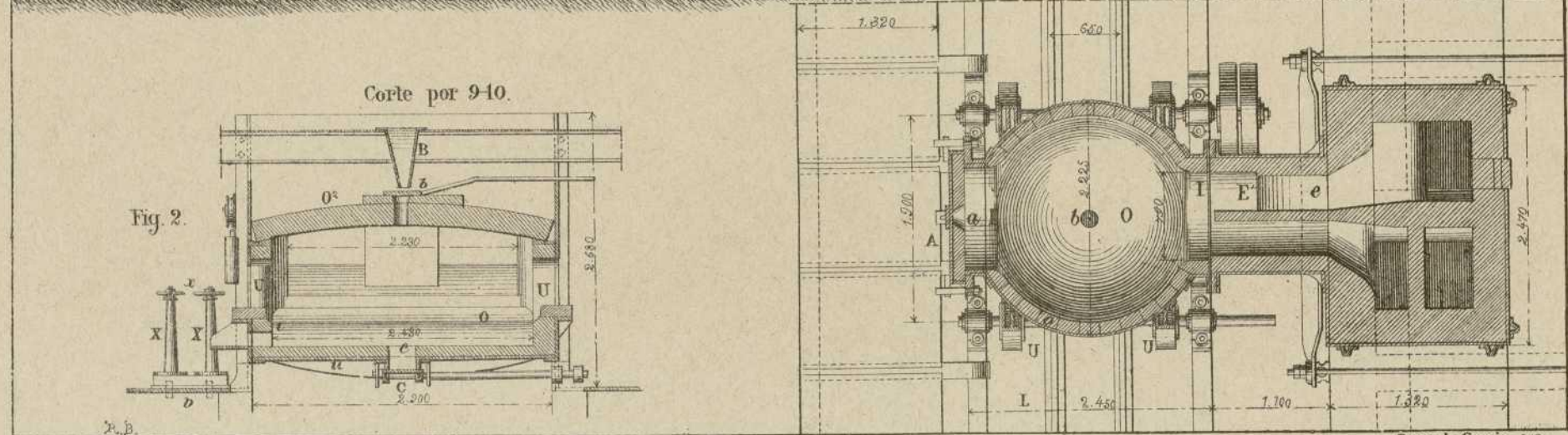


Fig. 2.

Corte por 9-10.

Fig. 4. Corte por 5 6 7 8.

X. B.
Nacente, editor.

Paseo de Gracia, 149.

Fig. 215.

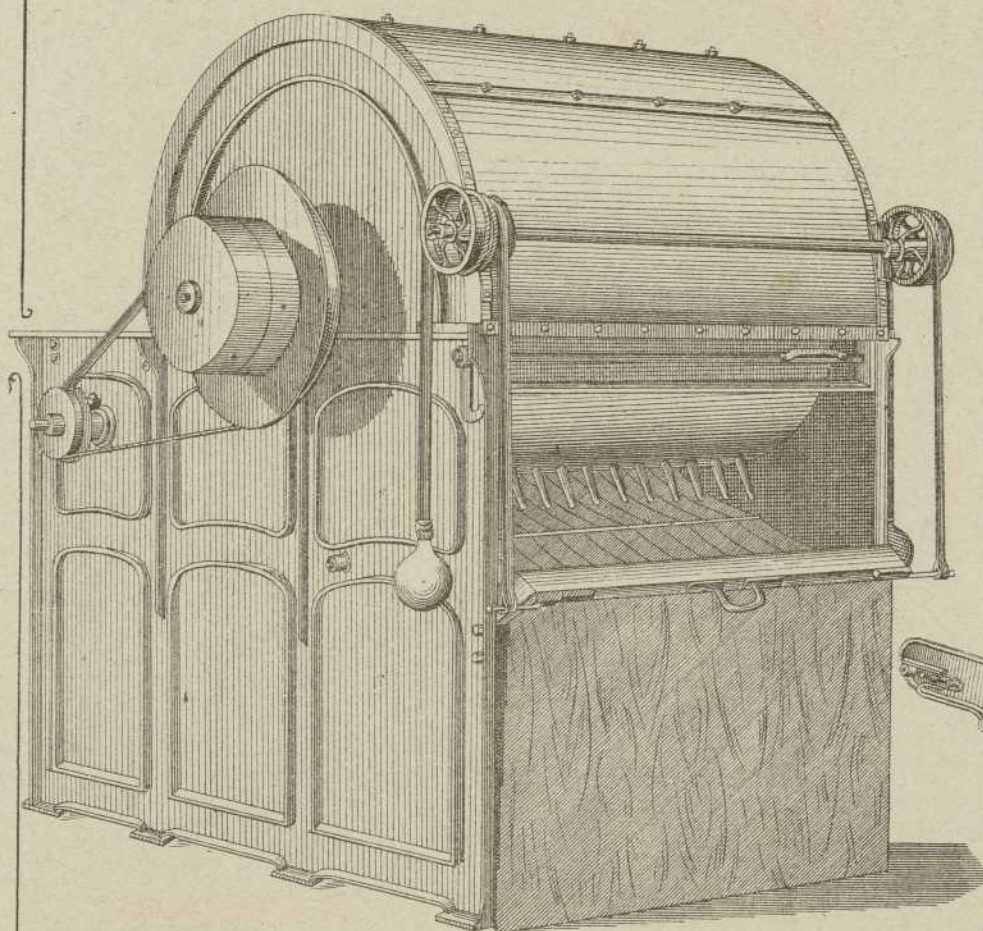


Fig. 217.

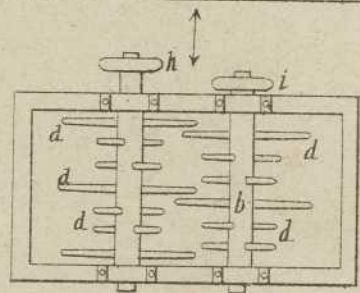
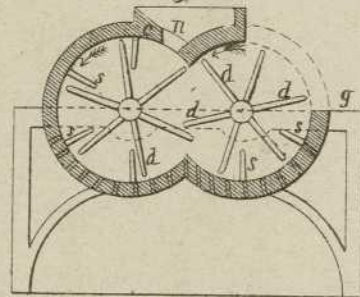


Fig. 214.

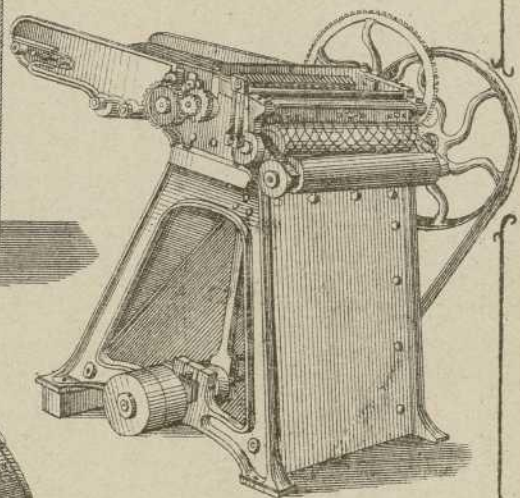


Fig. 216.

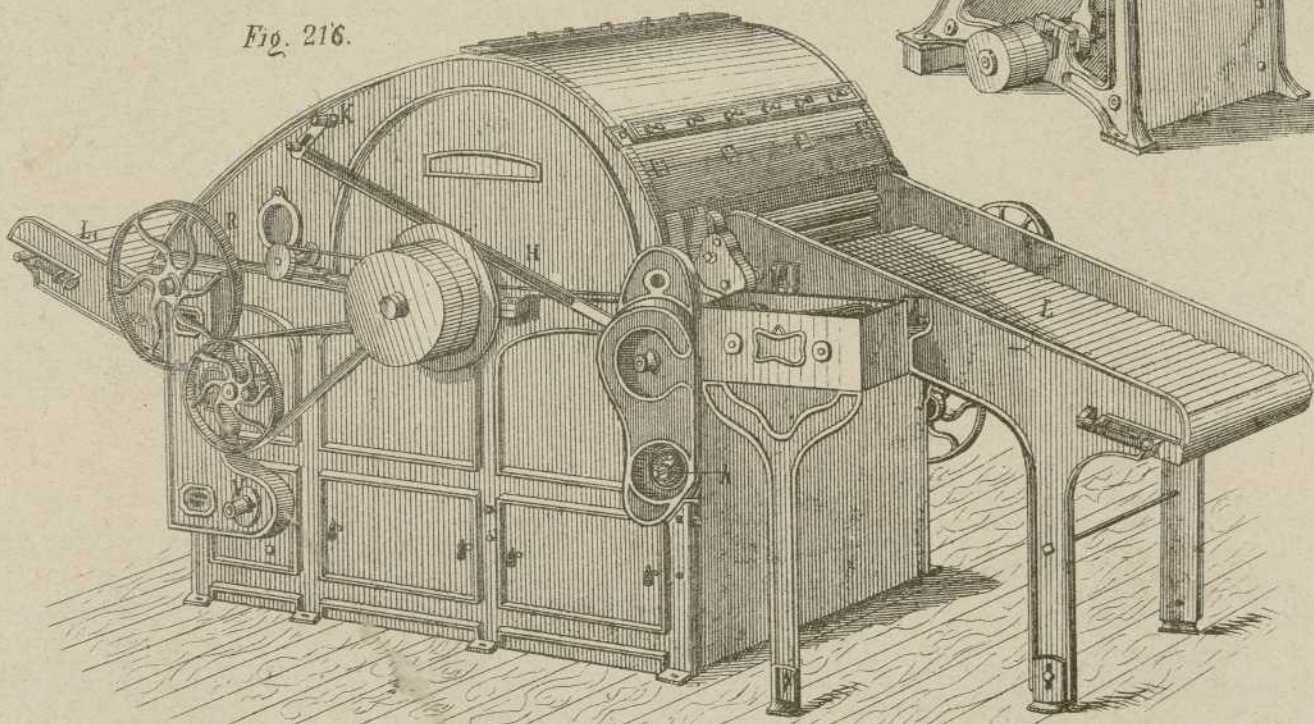


Fig. 218.

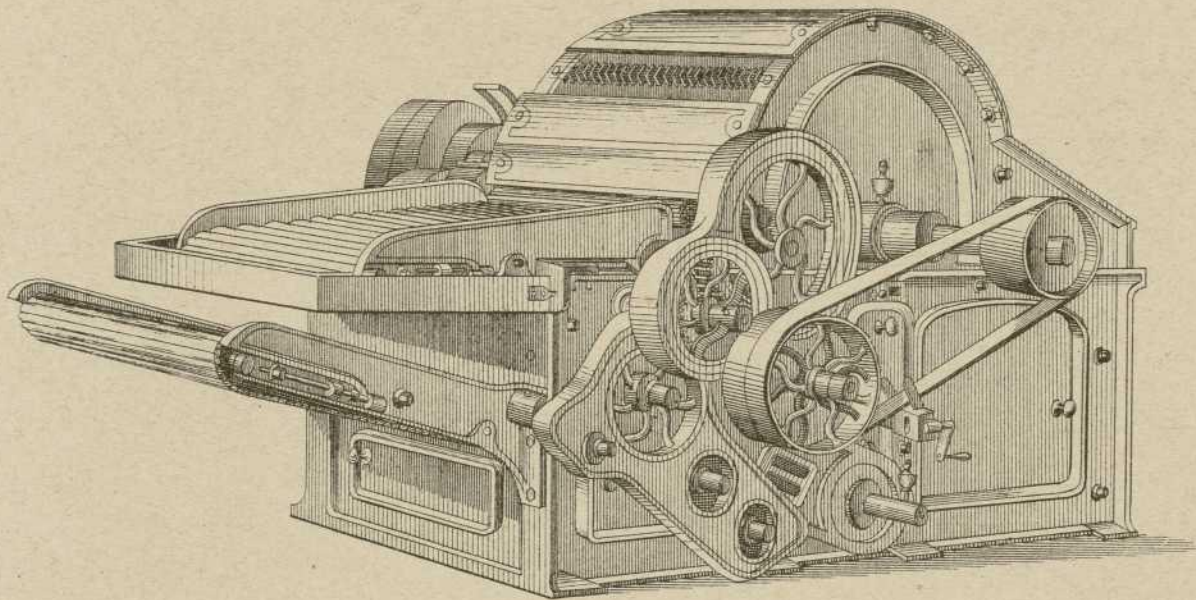


Fig. 220.

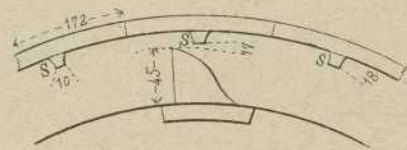


Fig. 219.

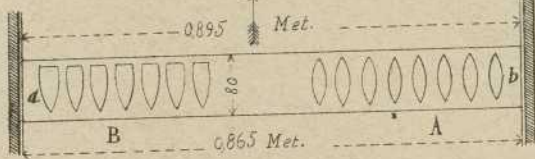


Fig. 221.

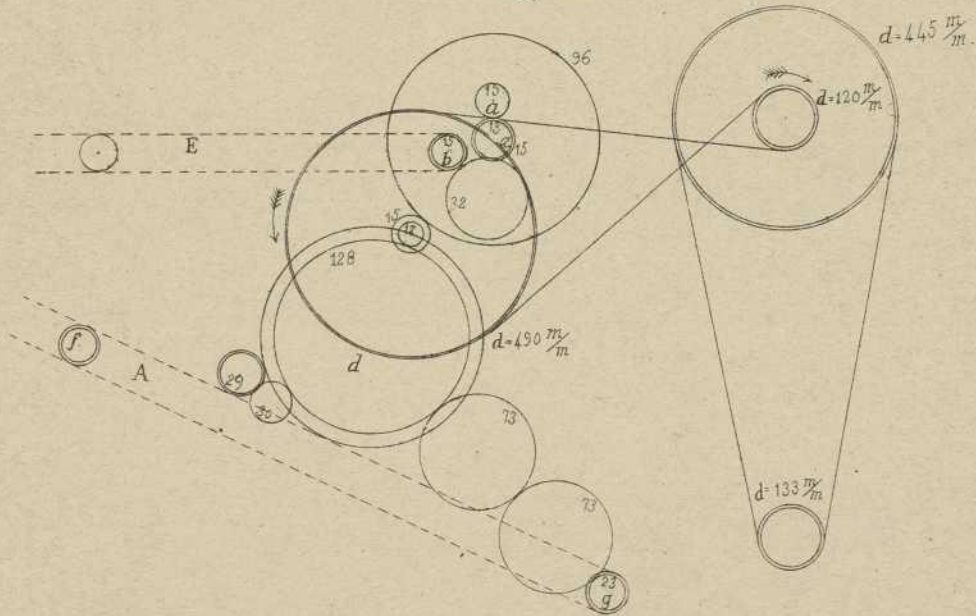


Fig. 222.

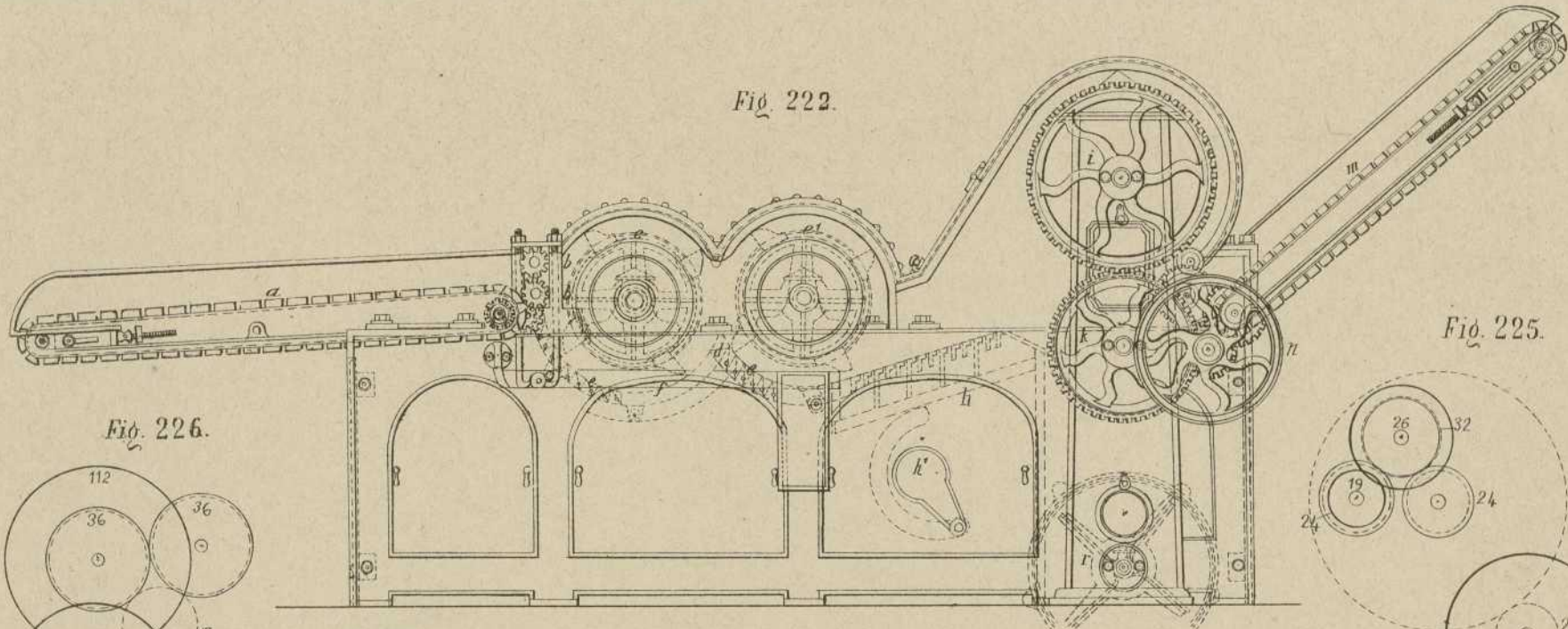


Fig. 225.

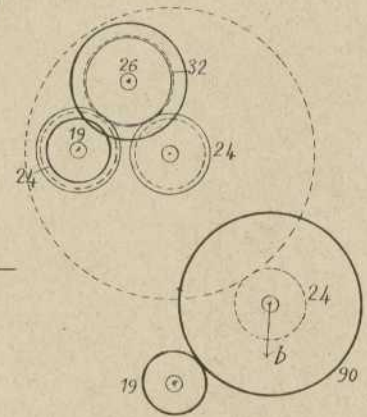


Fig. 226.

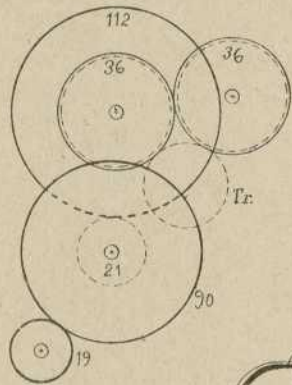


Fig. 223.

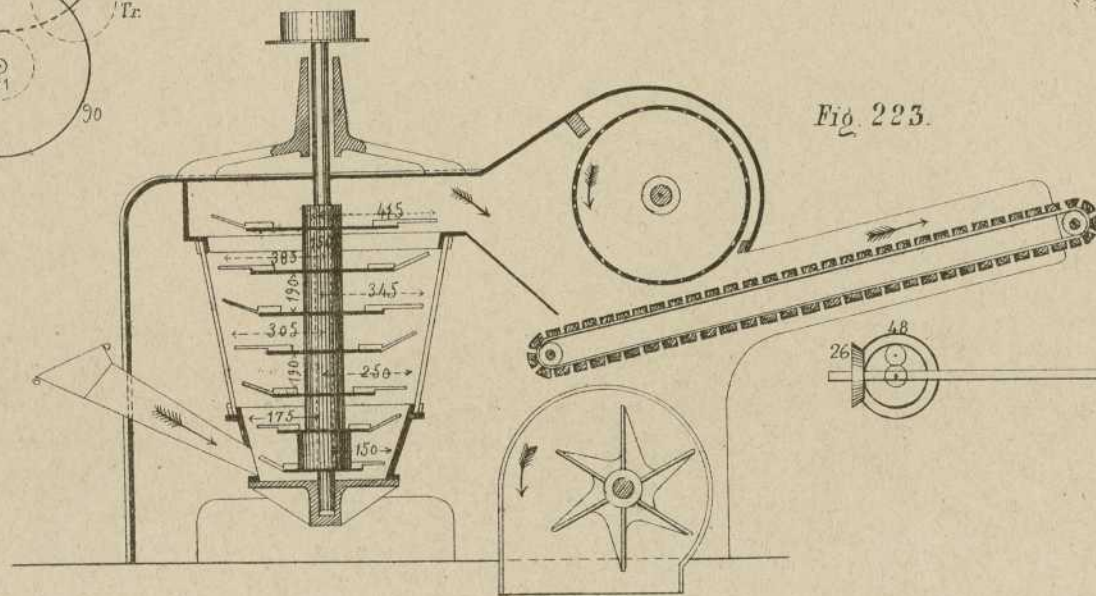
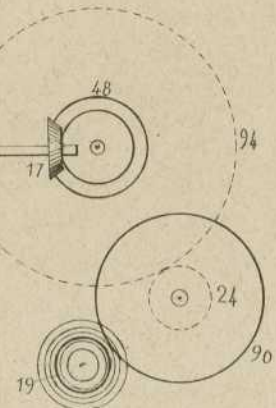
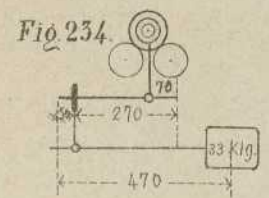
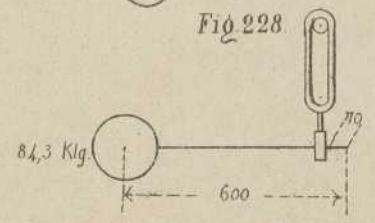
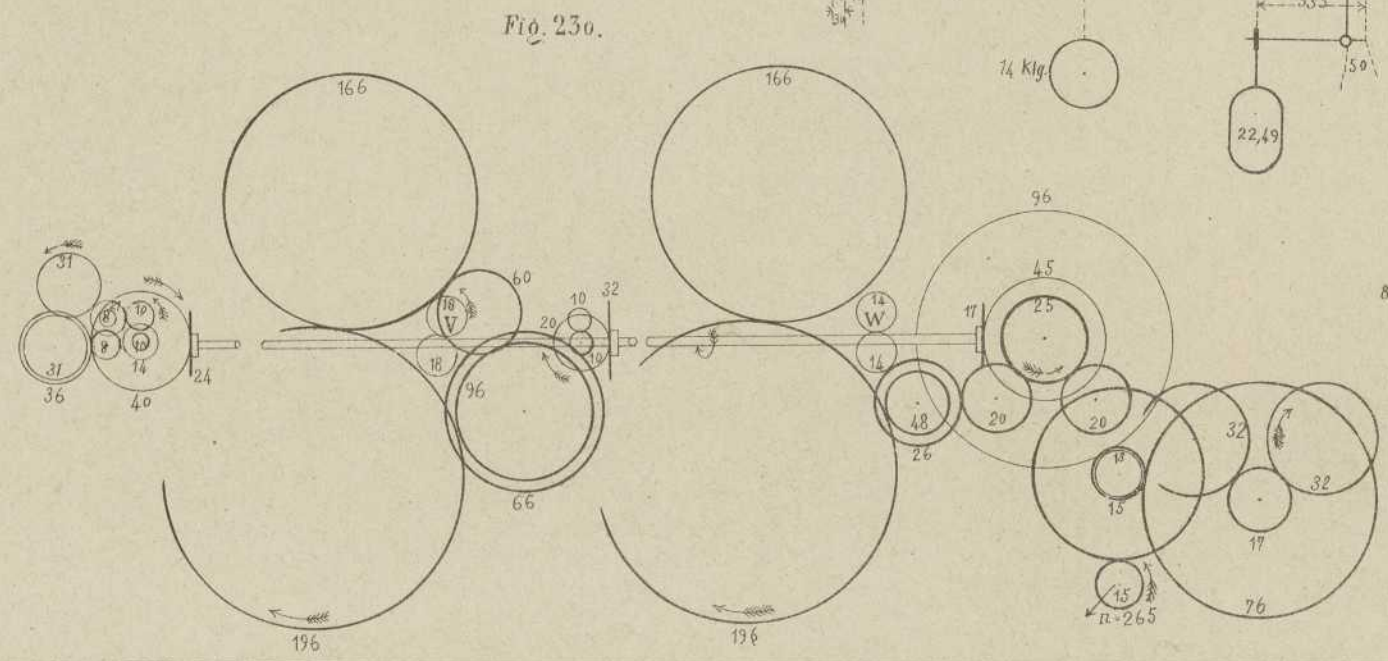
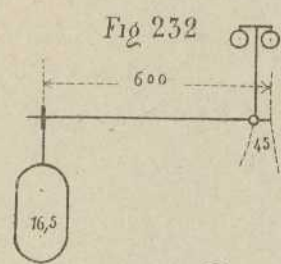
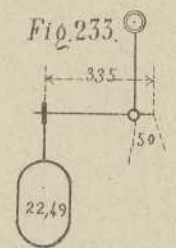
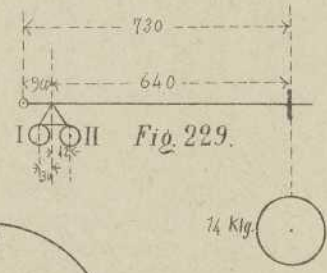
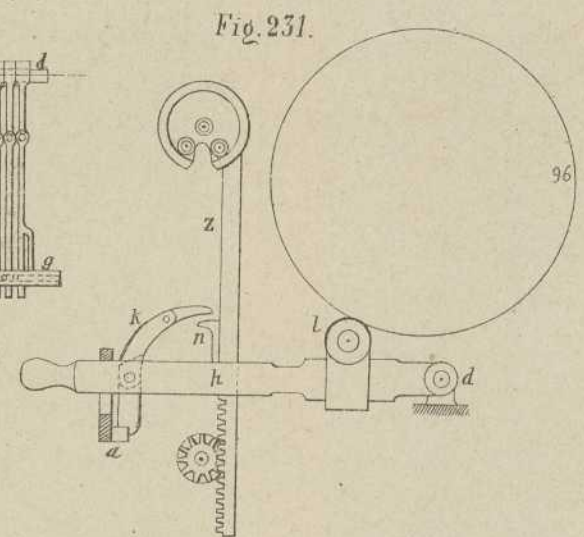
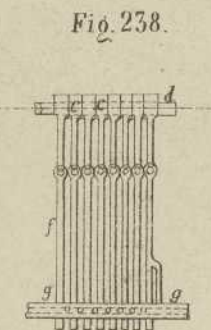
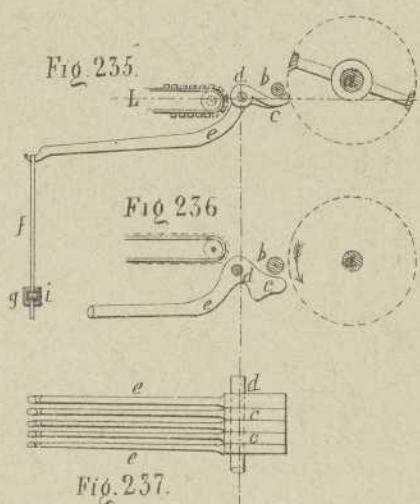
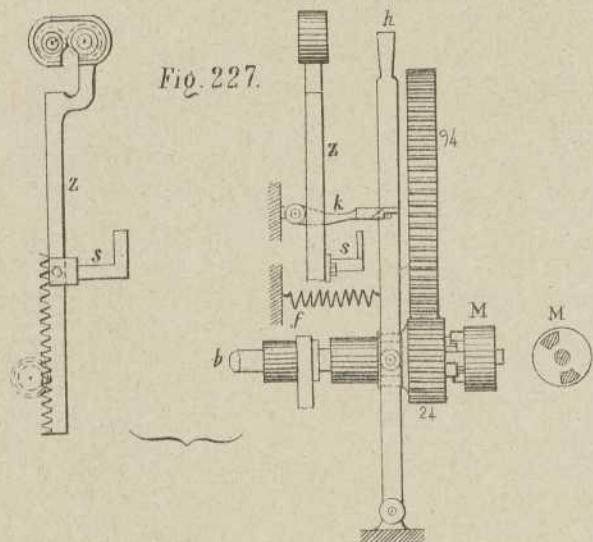


Fig. 224.





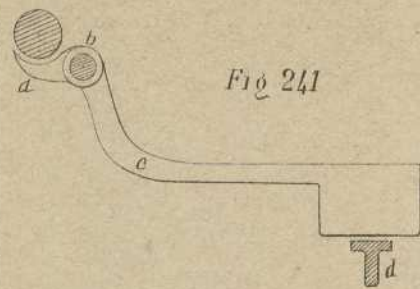


Fig. 241

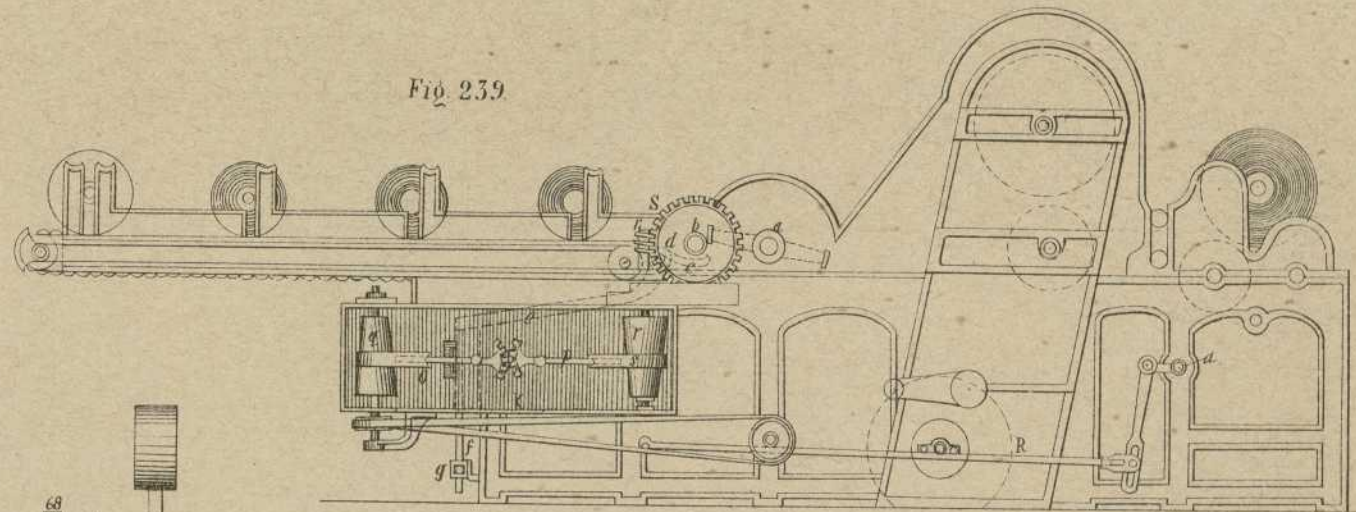


Fig. 239

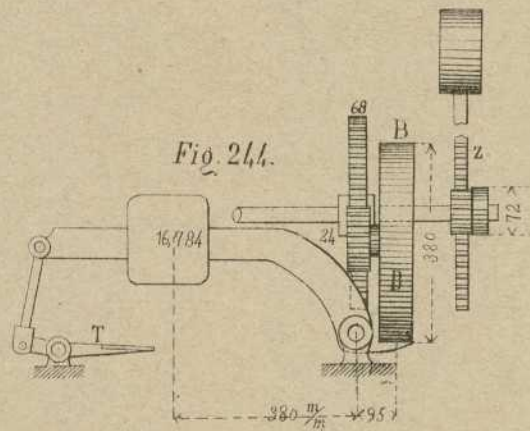


Fig. 244.

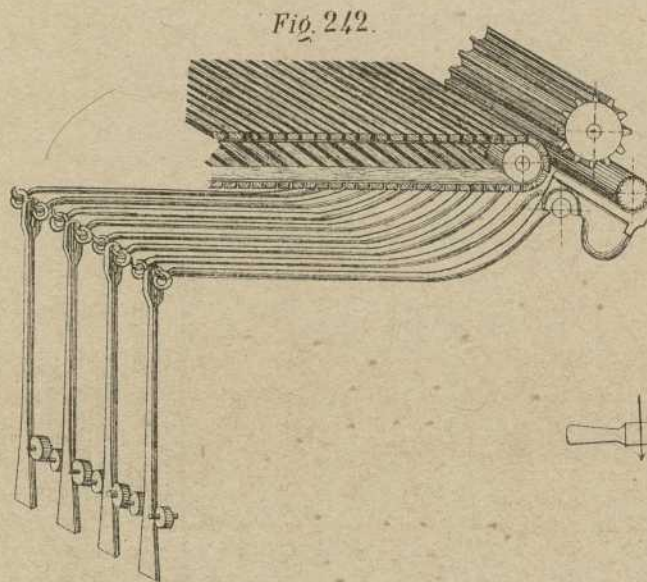


Fig. 242.

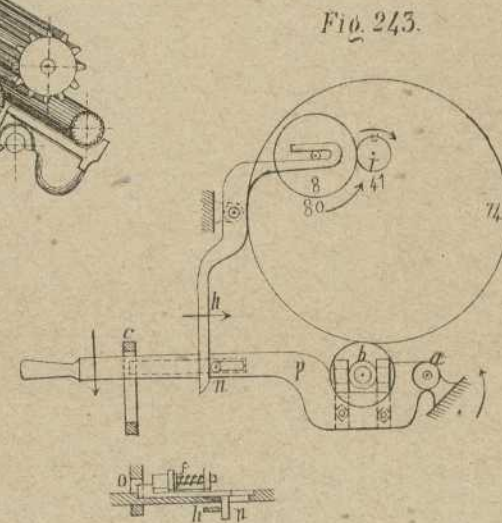


Fig. 243.

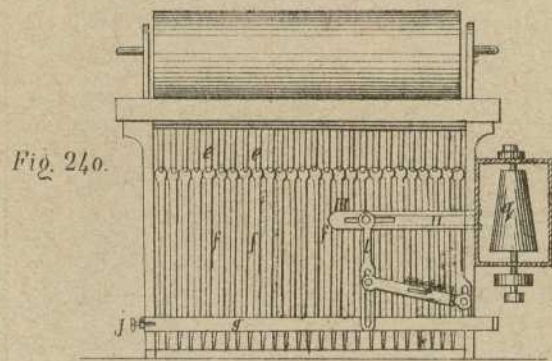


Fig. 240.

Fig. 245.

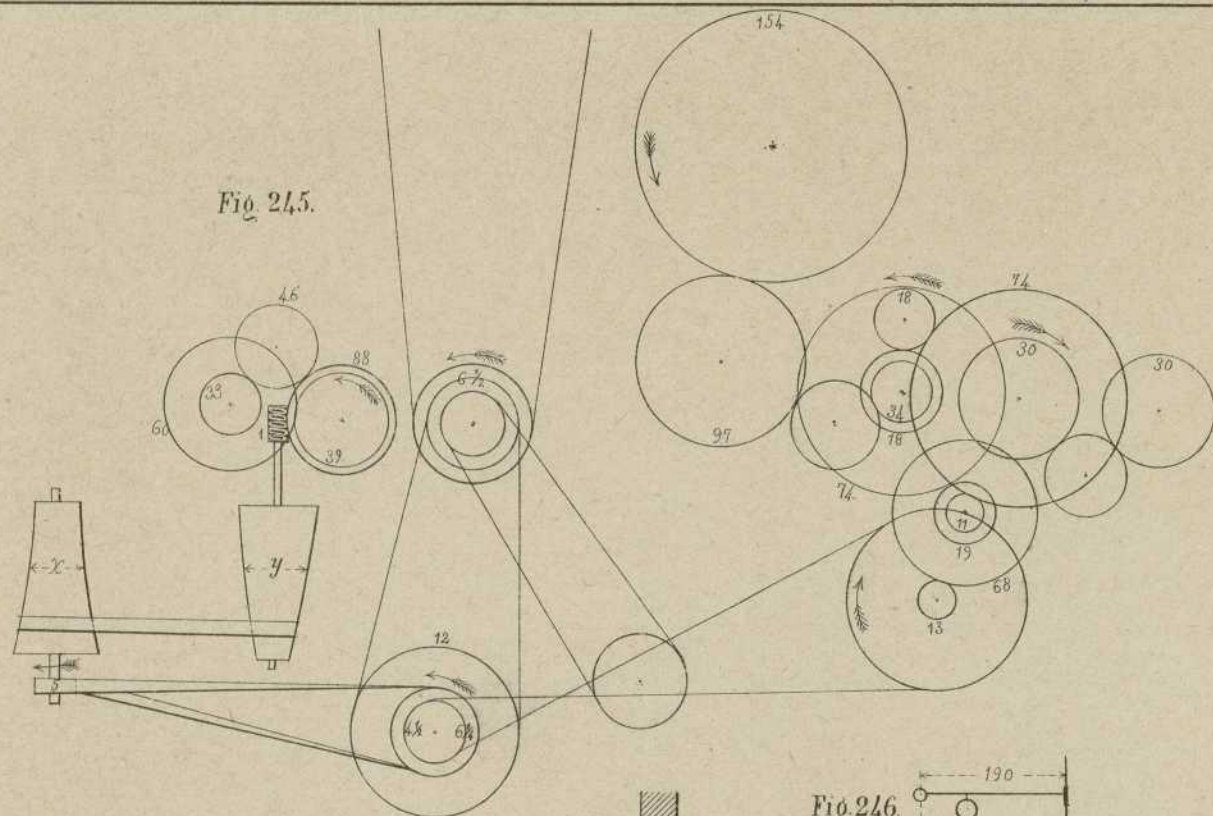


Fig. 248.

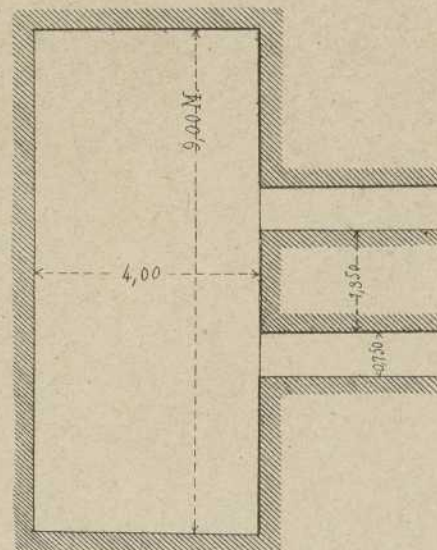


Fig. 249.

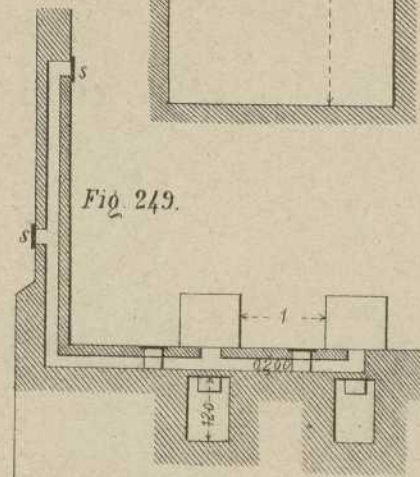


Fig. 246.

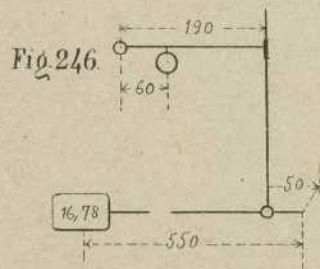
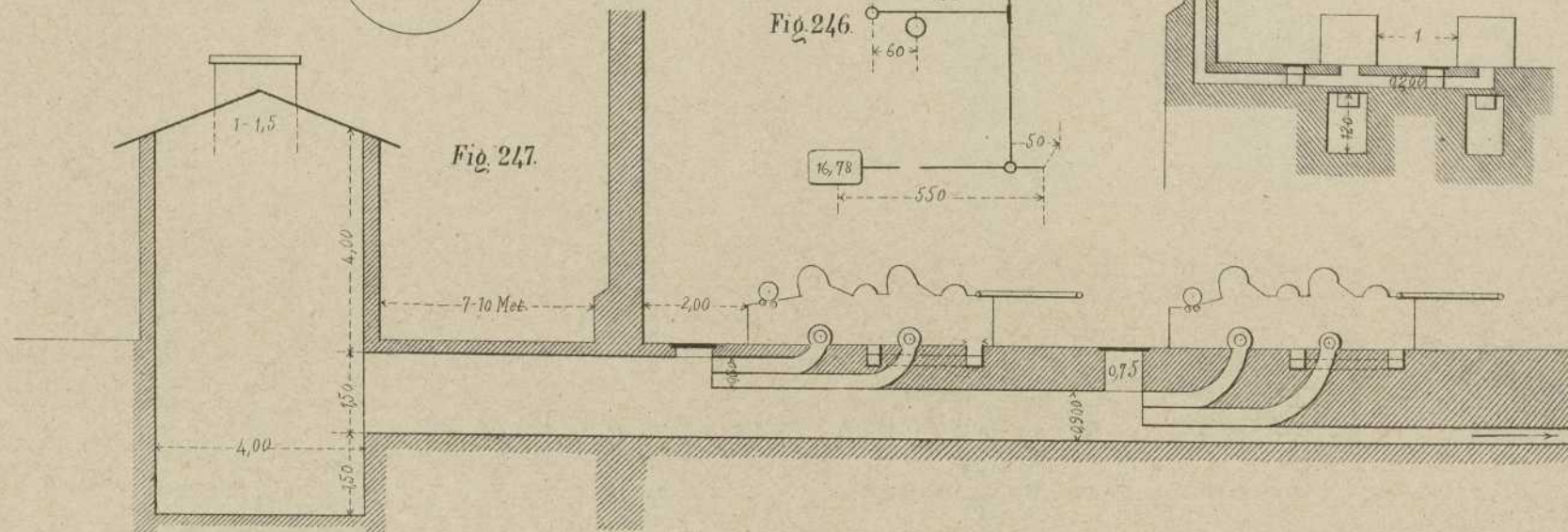


Fig. 247.



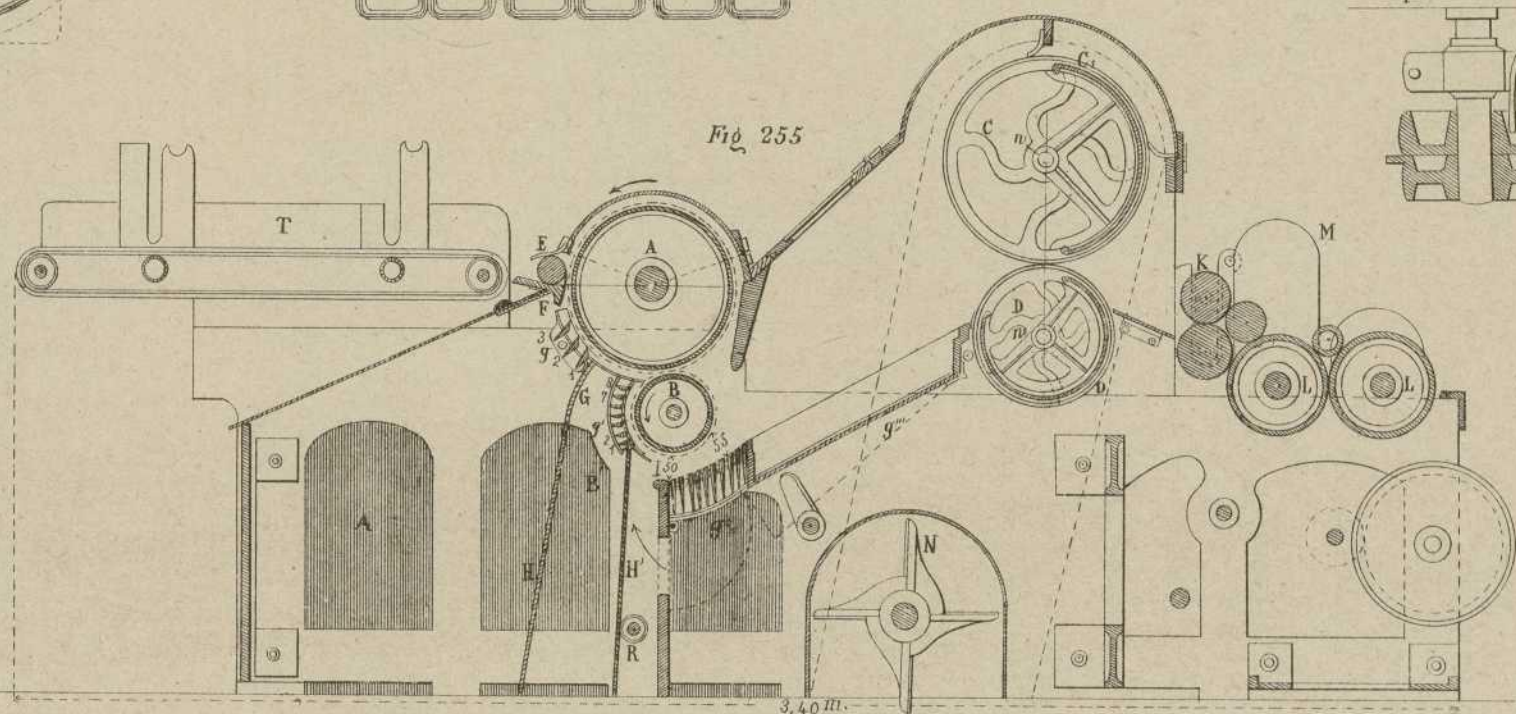
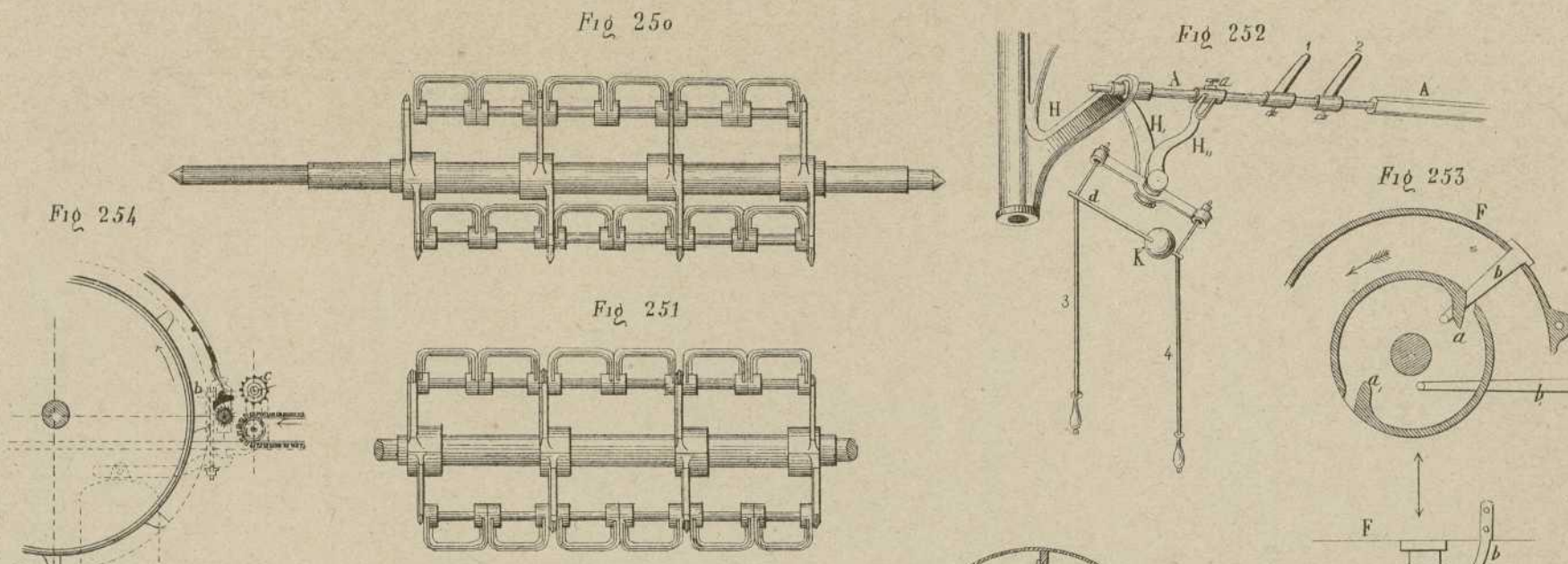


Fig. 258.

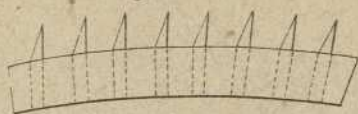


Fig. 257.

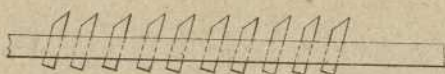


Fig. 256.

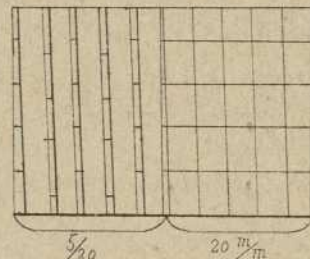
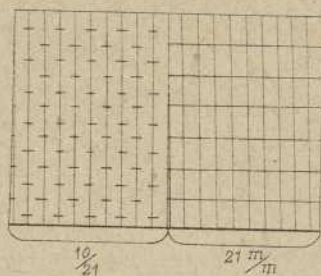
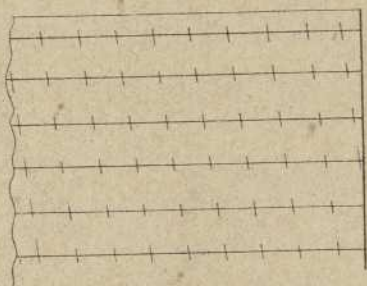
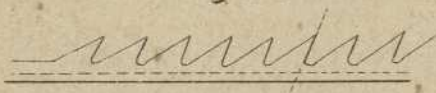


Fig. 268.

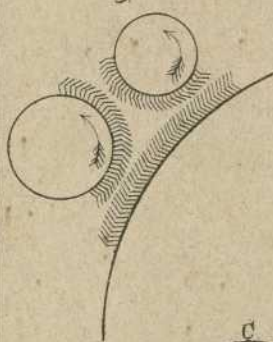


Fig. 270.

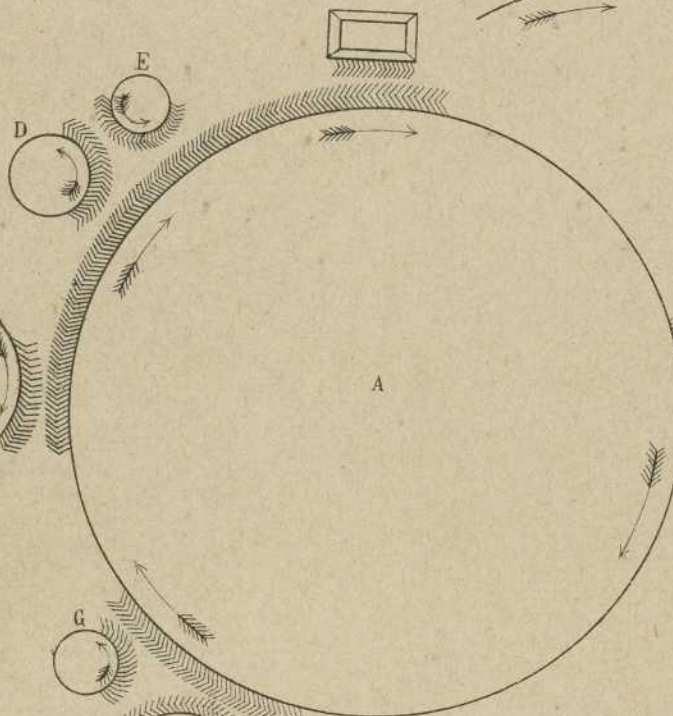


Fig. 266.

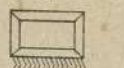


Fig. 267.

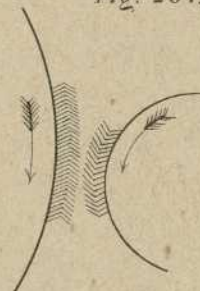


Fig. 264.

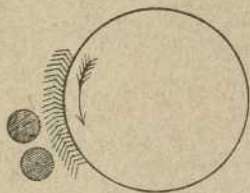


Fig. 261.



Fig. 265.

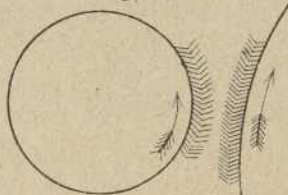


Fig. 260.

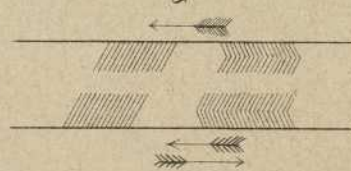


Fig. 269.

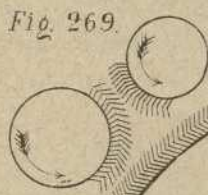


Fig. 263.

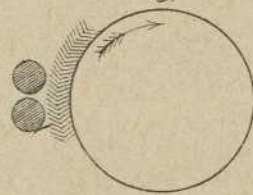


Fig. 259.

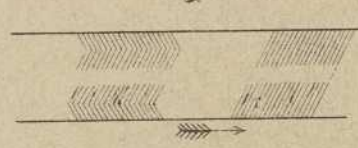


Fig. 262.

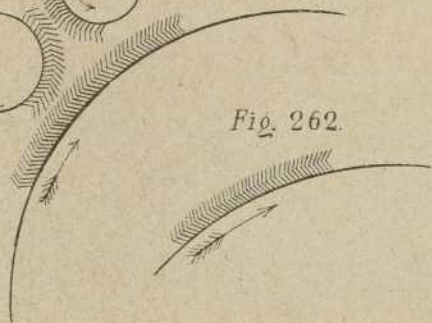


Fig. 290.

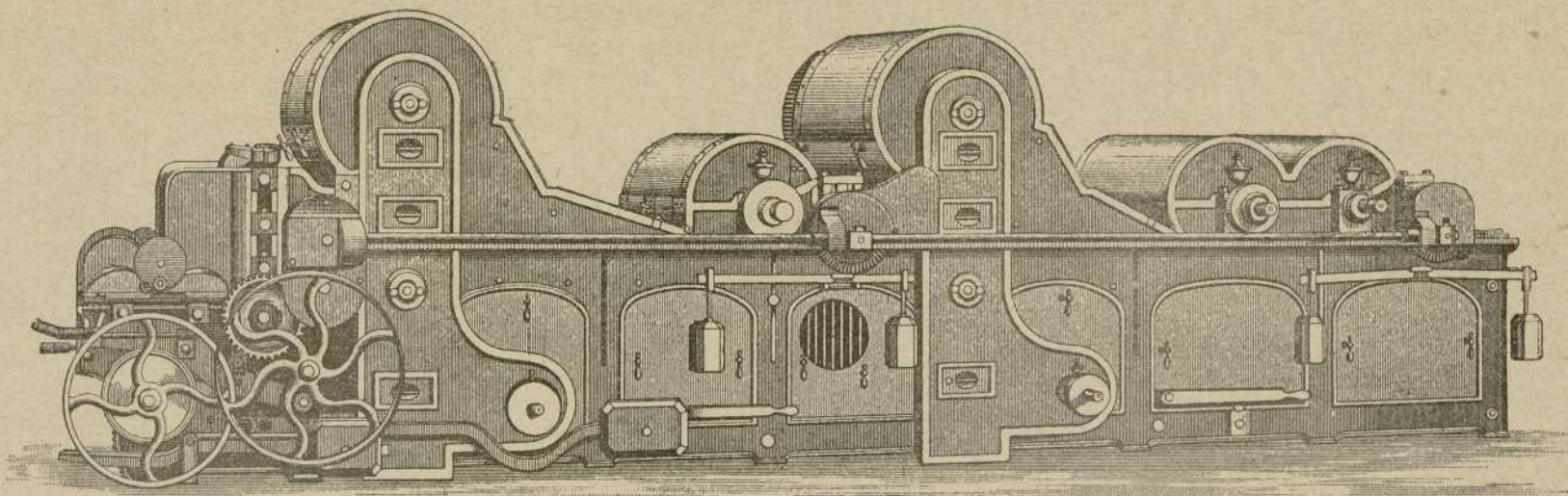
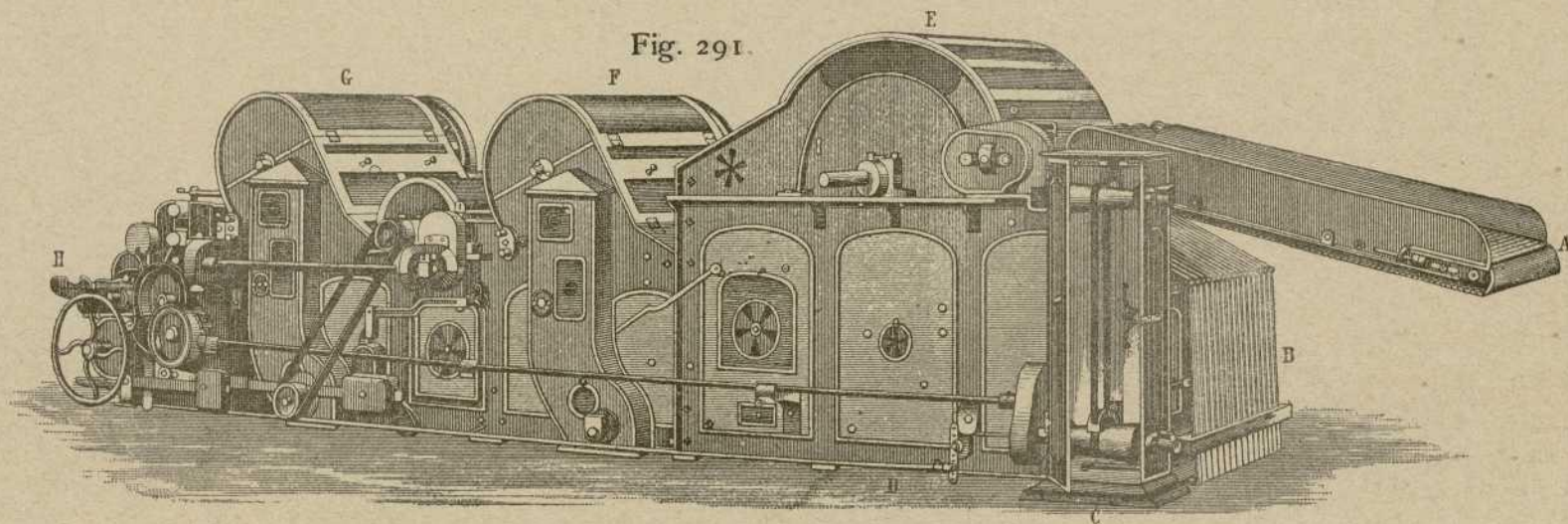


Fig. 291.



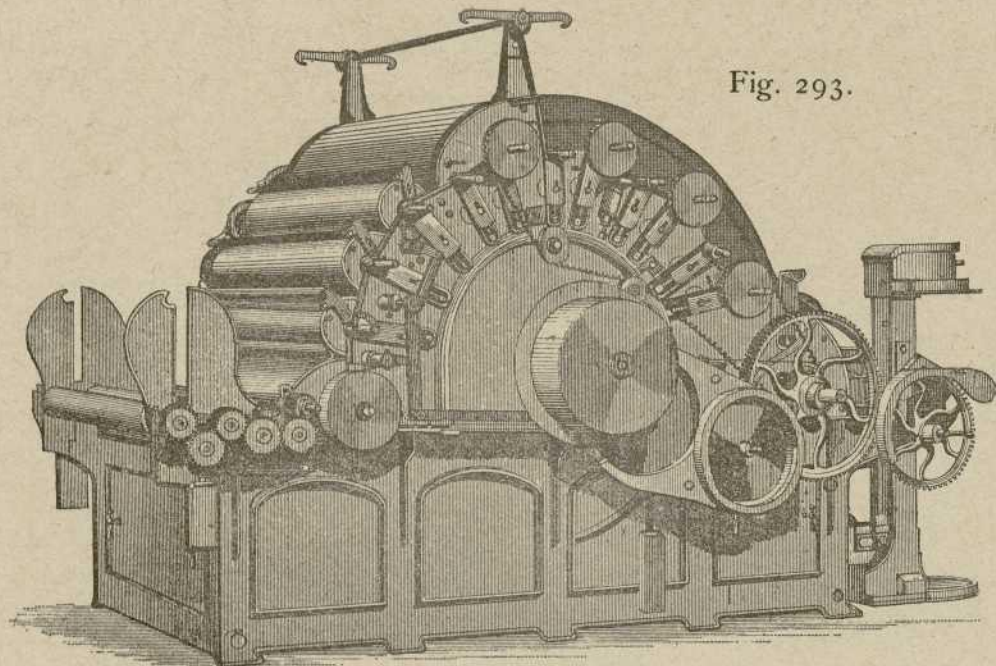


Fig. 293.

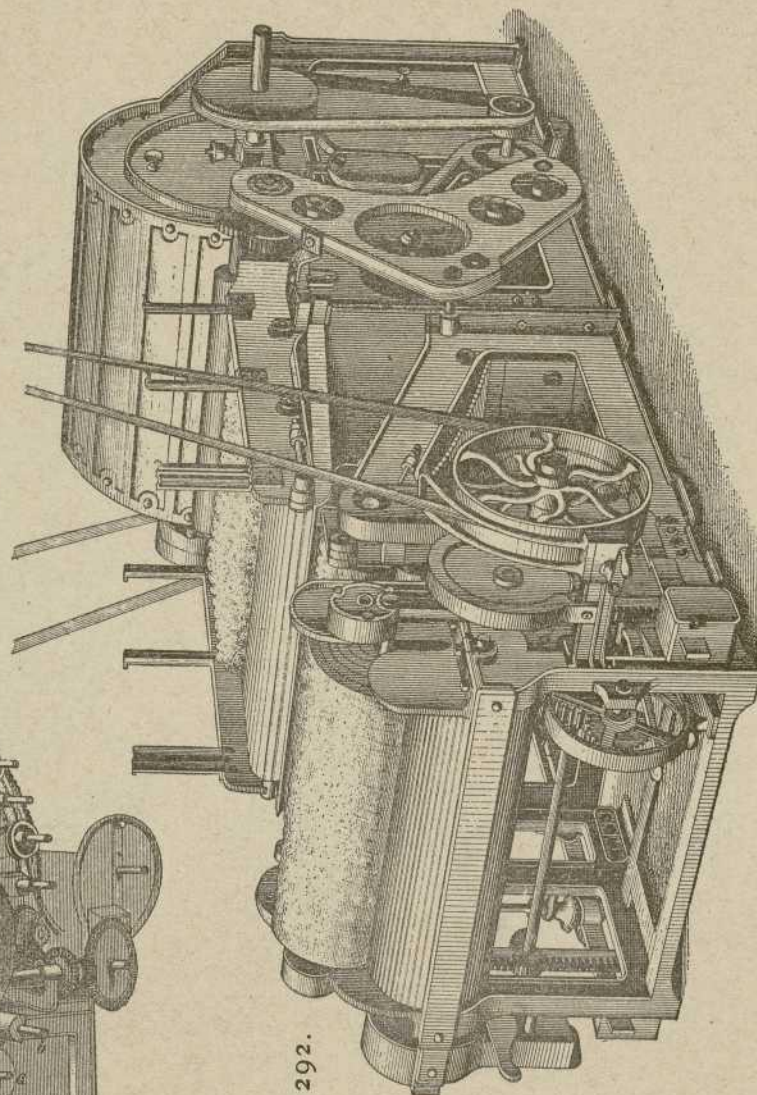


Fig. 292.

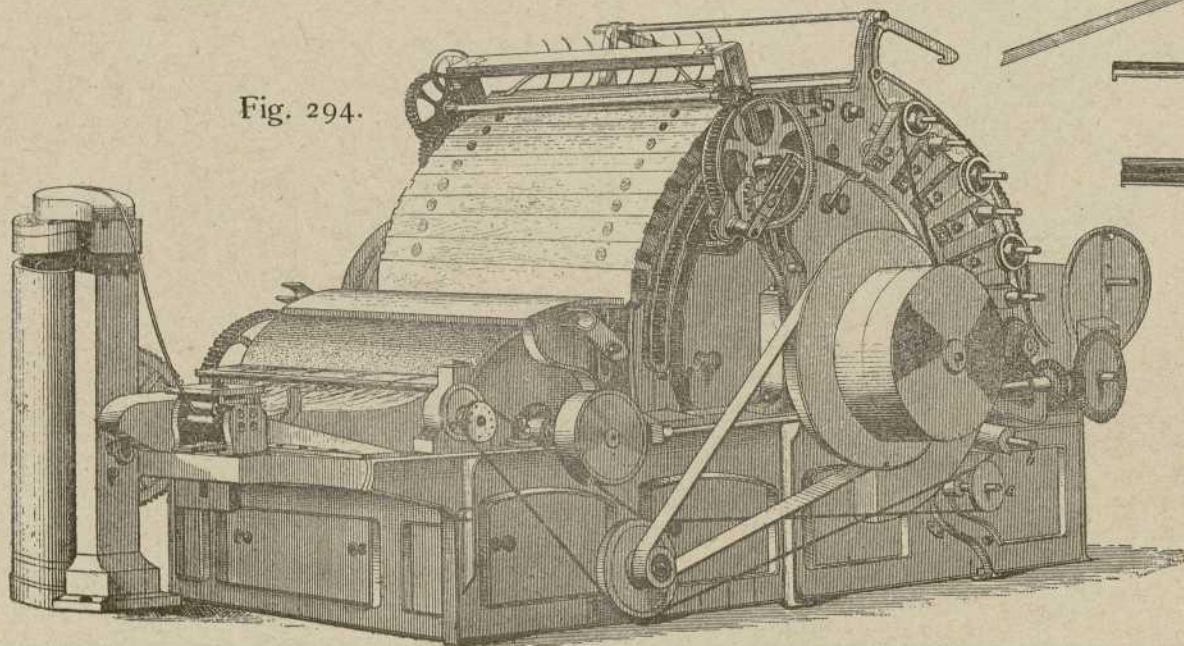


Fig. 294.

Fig. 295.

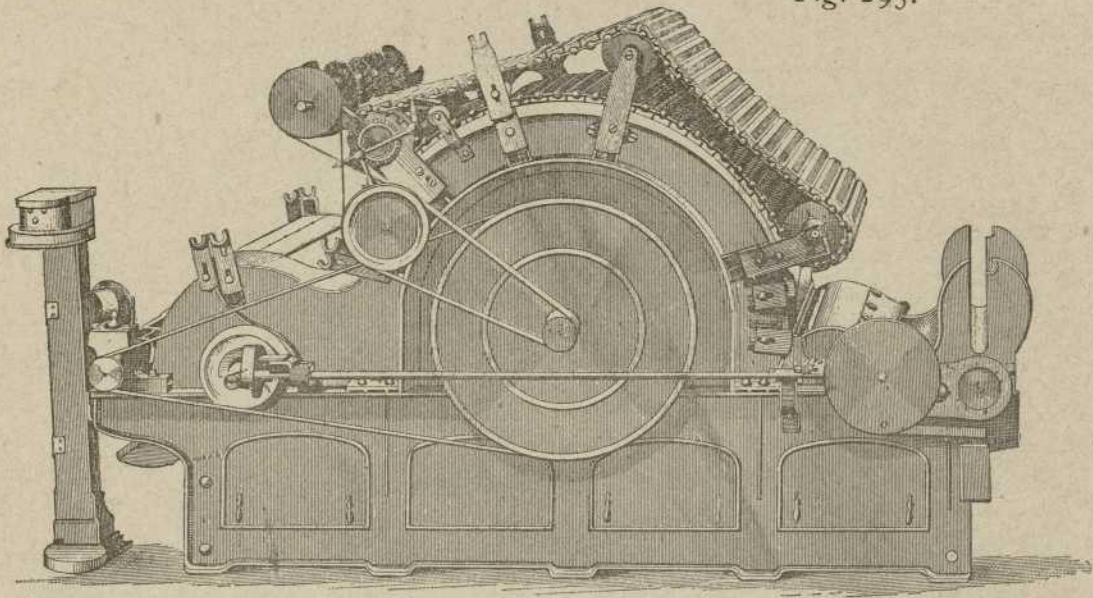


Fig. 296.

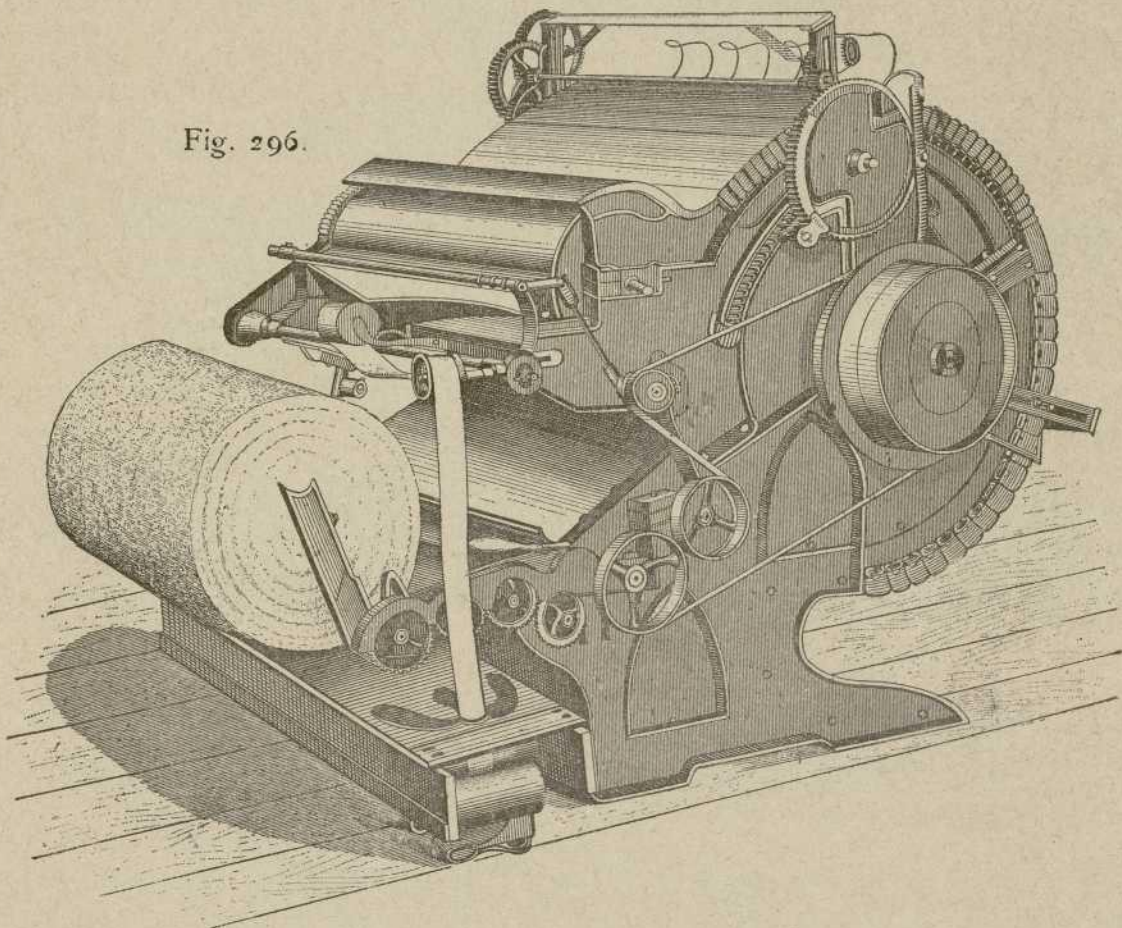


Fig. 298.

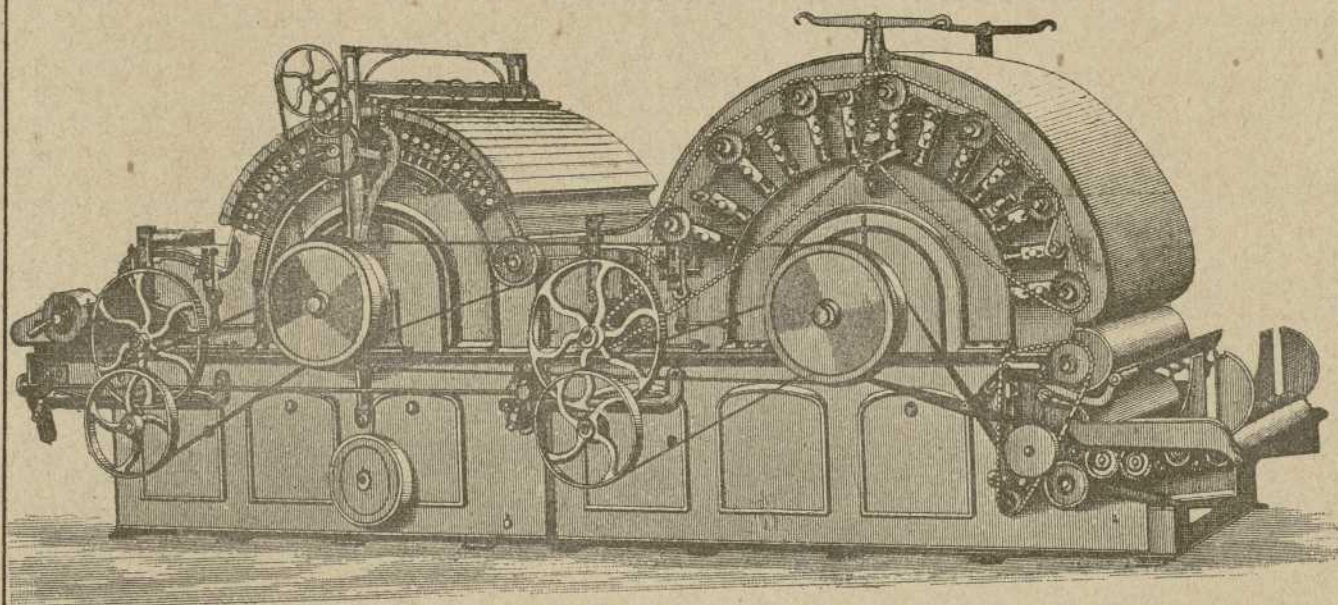


Fig. 297.

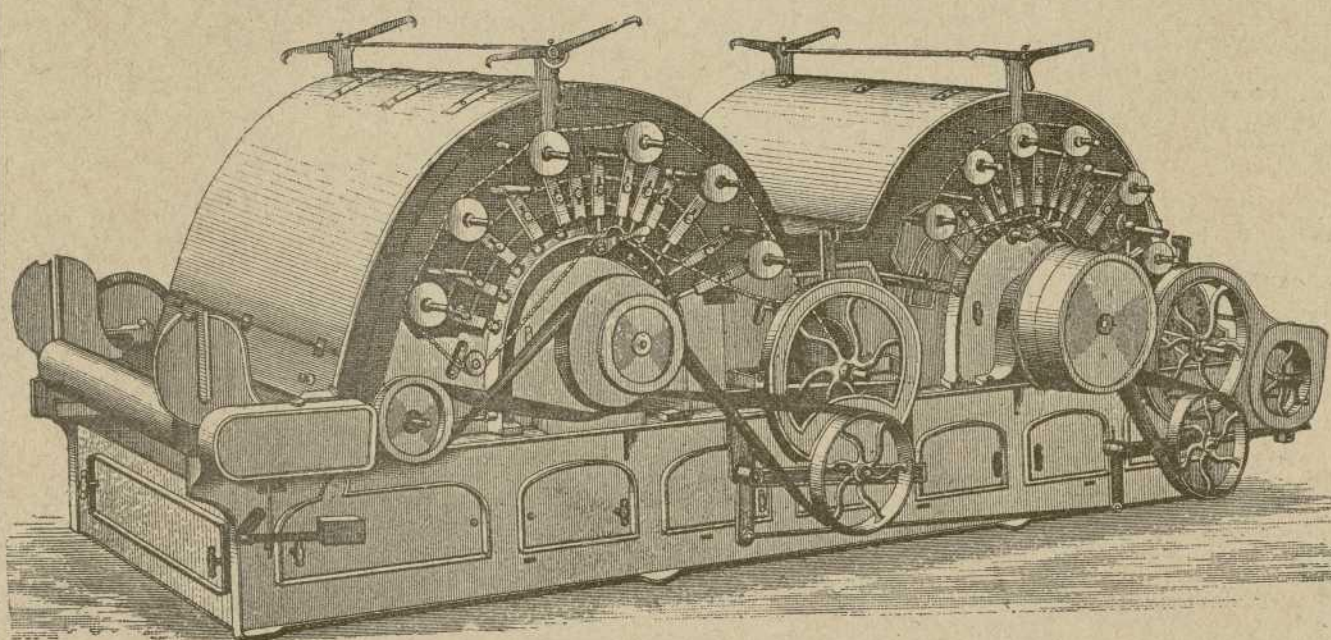


Fig. 271.



Fig. 272.



Fig. 273.



Fig. 287.

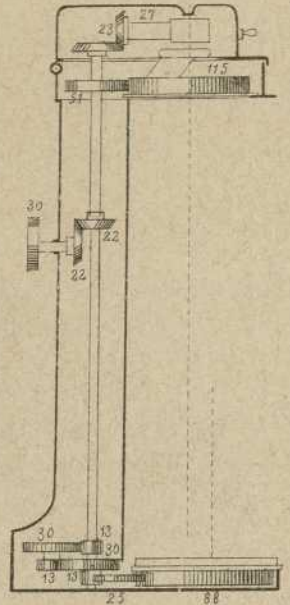


Fig. 273.



Fig. 274.



Fig. 275.



Fig. 276.



Fig. 285.

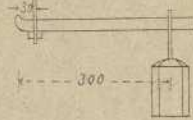


Fig. 277.

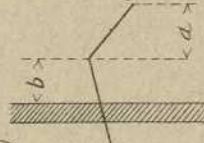


Fig. 281.

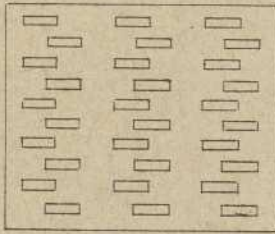


Fig. 284.

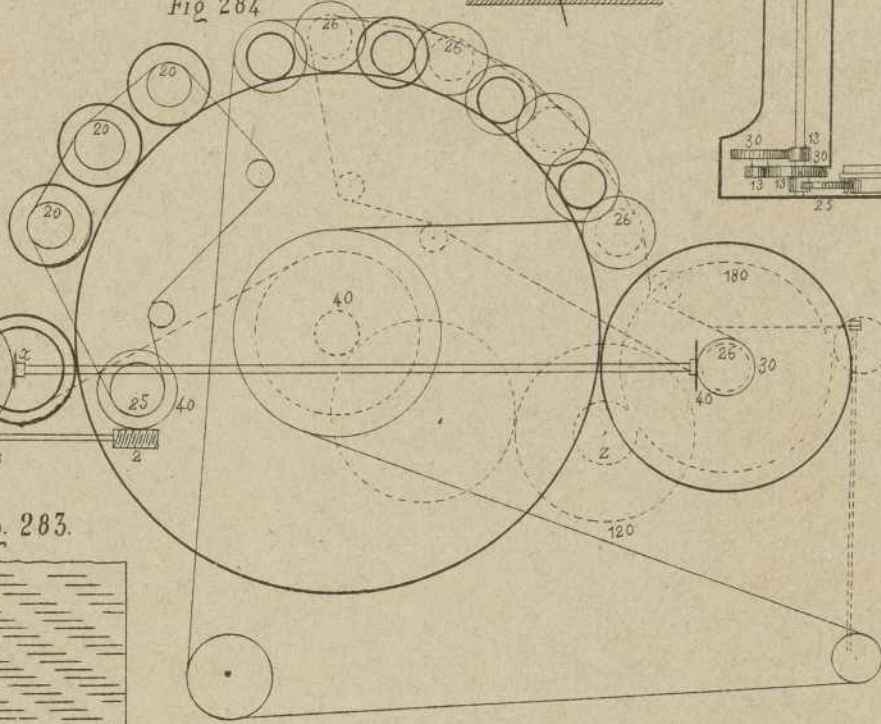


Fig. 280.



Fig. 283.



Fig. 279.



Fig. 286.

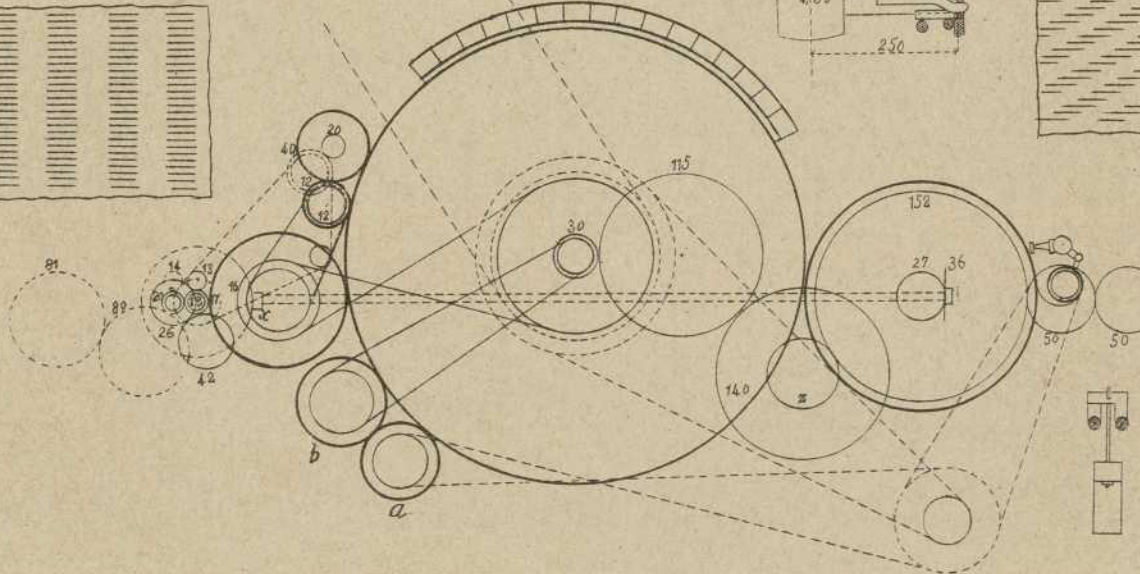


Fig. 288.

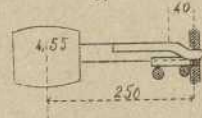


Fig. 282.



Fig. 289.

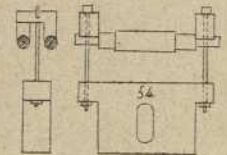


Fig. 303.

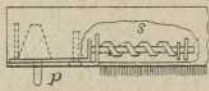


Fig. 299

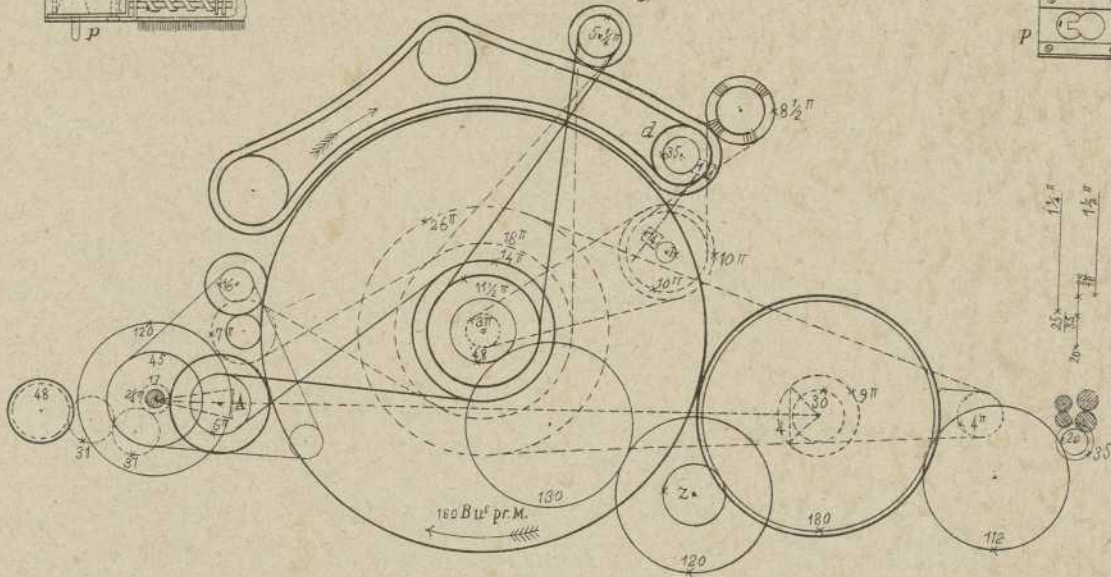


Fig. 302

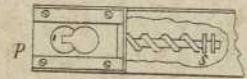
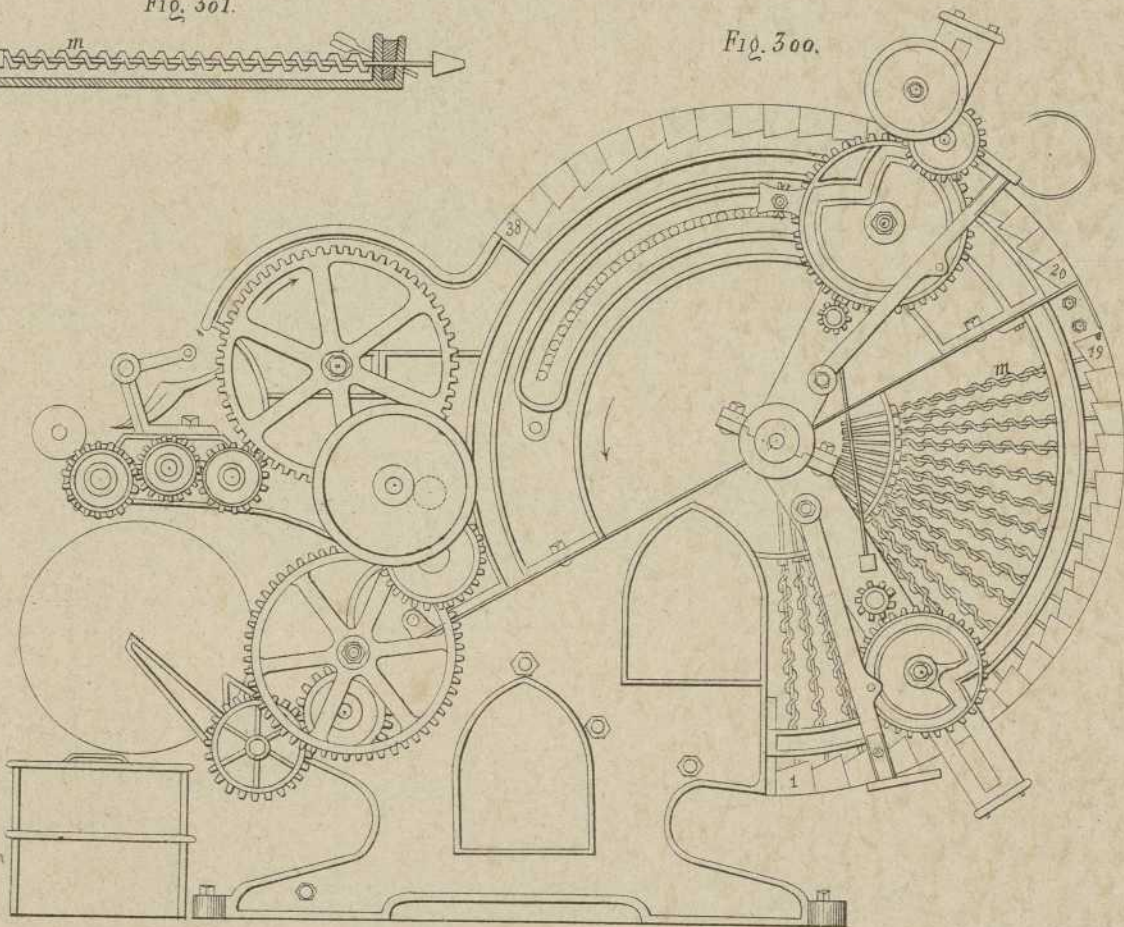


Fig. 301.



Fig. 300.



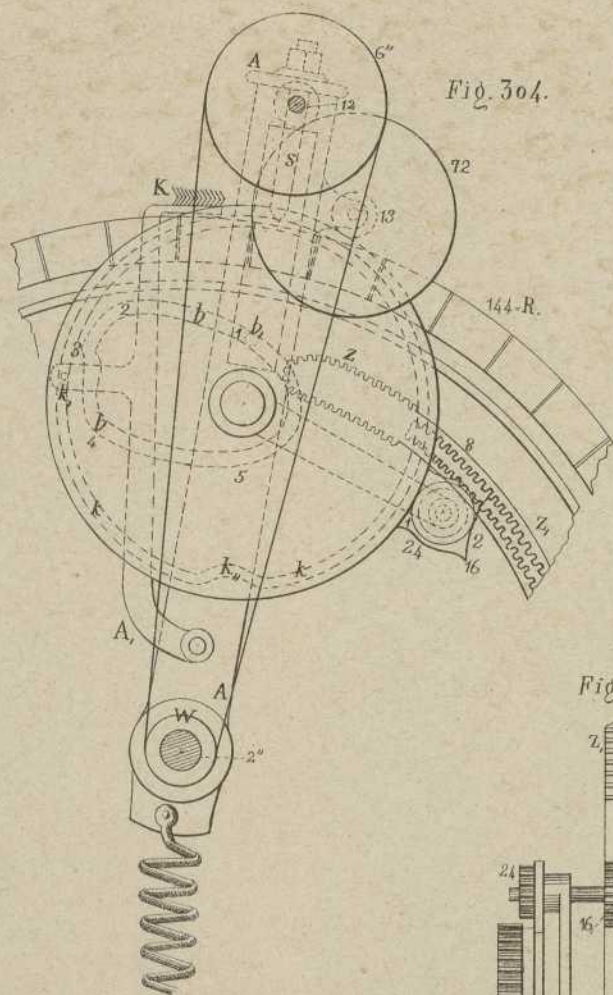


Fig. 304.

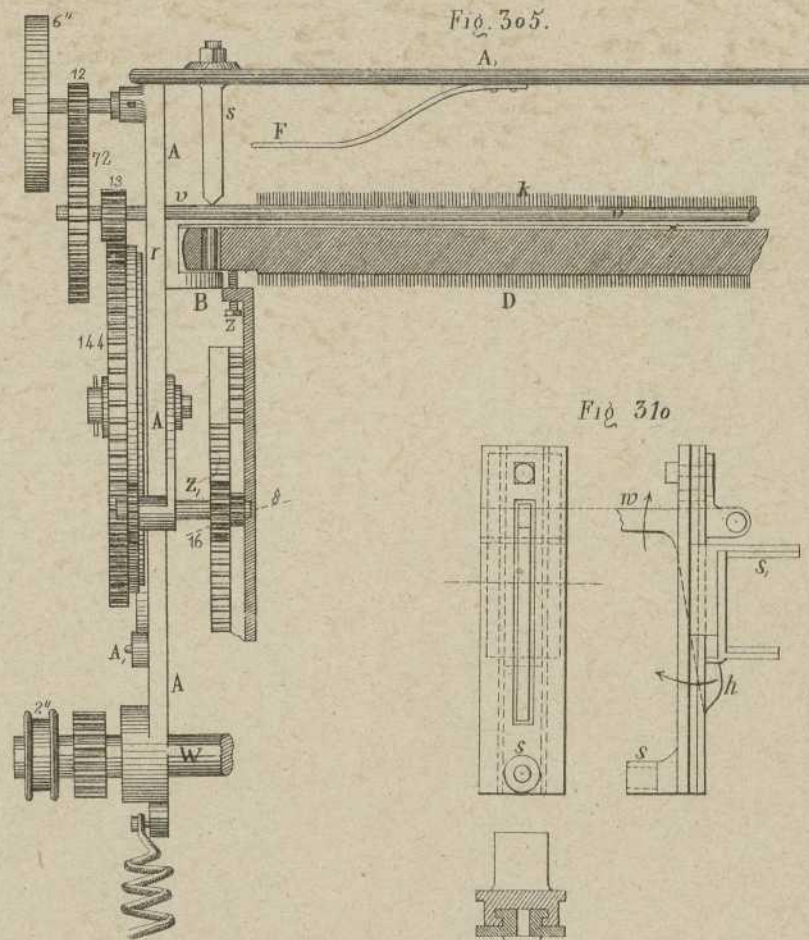


Fig. 305.

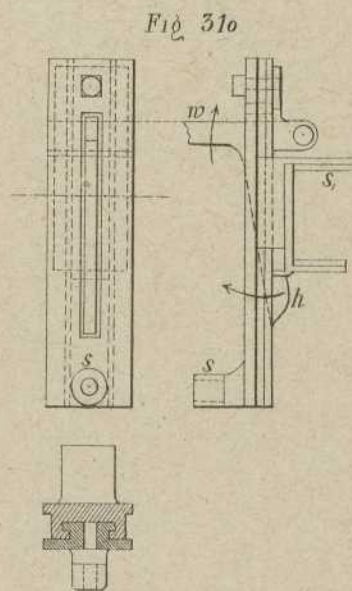


Fig. 310.

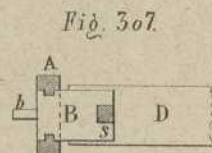


Fig. 307.

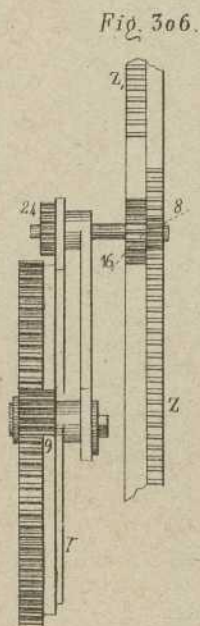


Fig. 306.

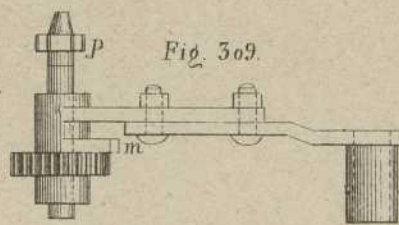


Fig. 309.

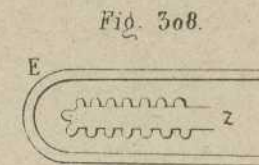


Fig. 308.

Fig. 311.

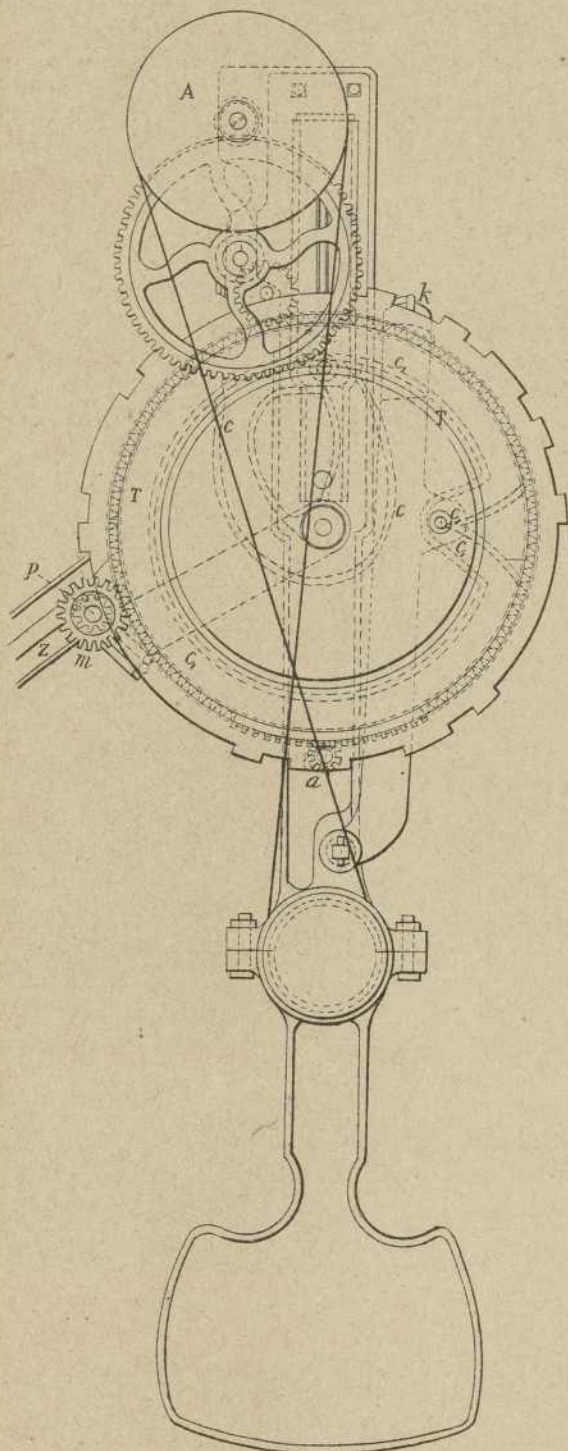
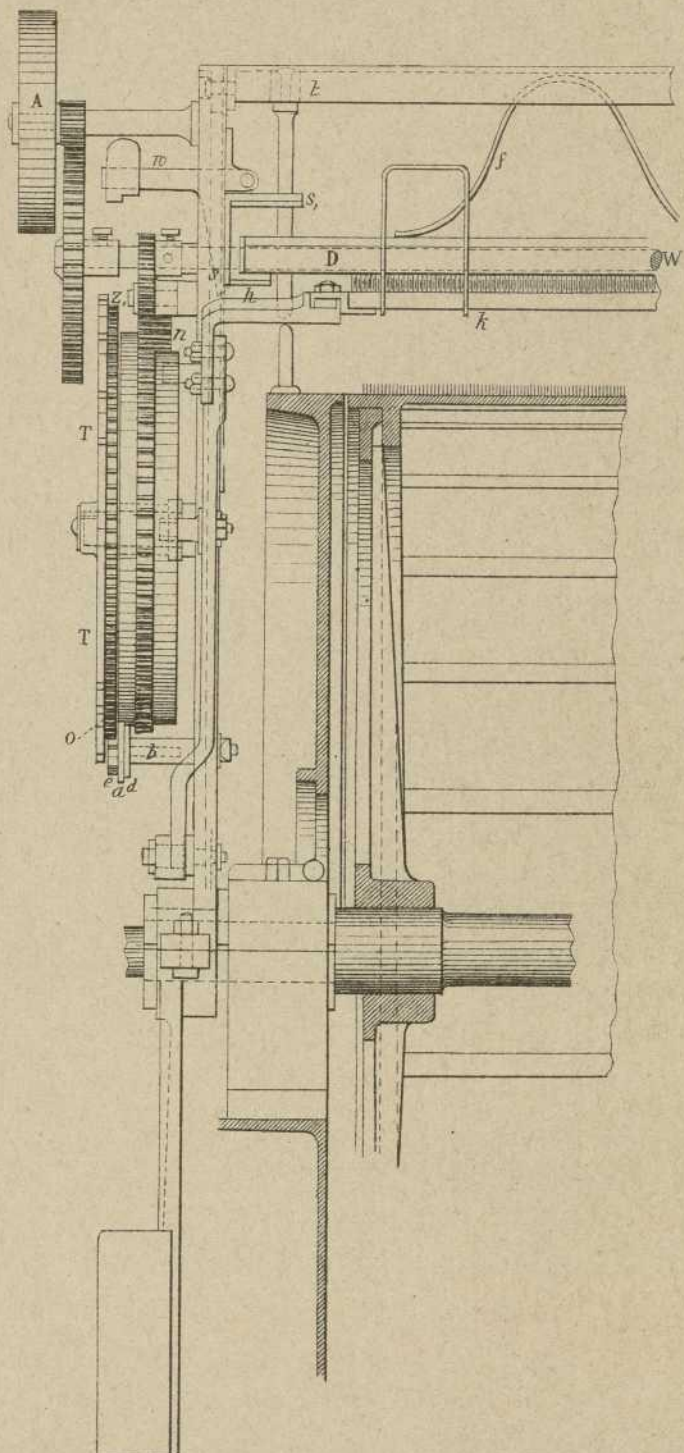


Fig. 312.



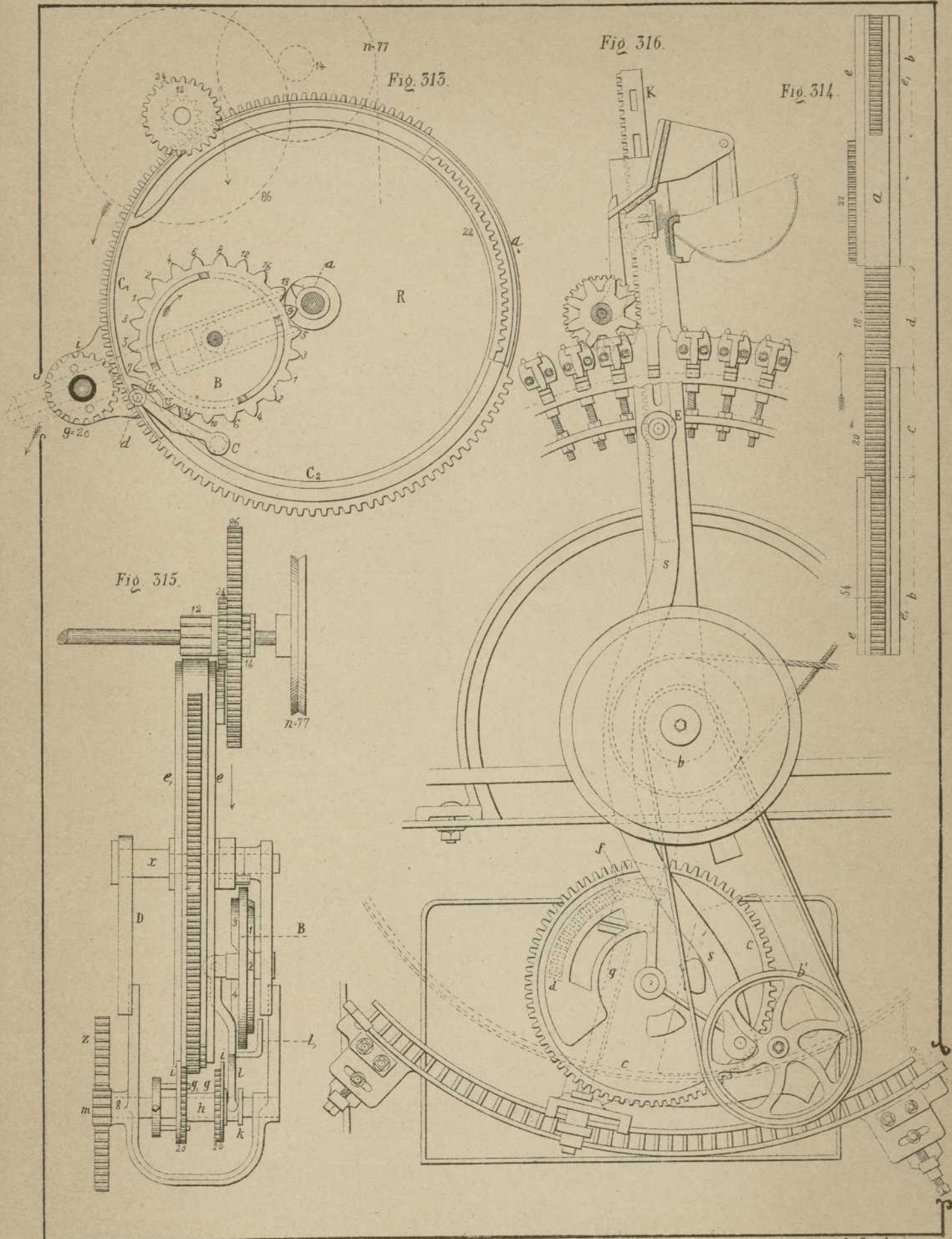


Fig. 317.

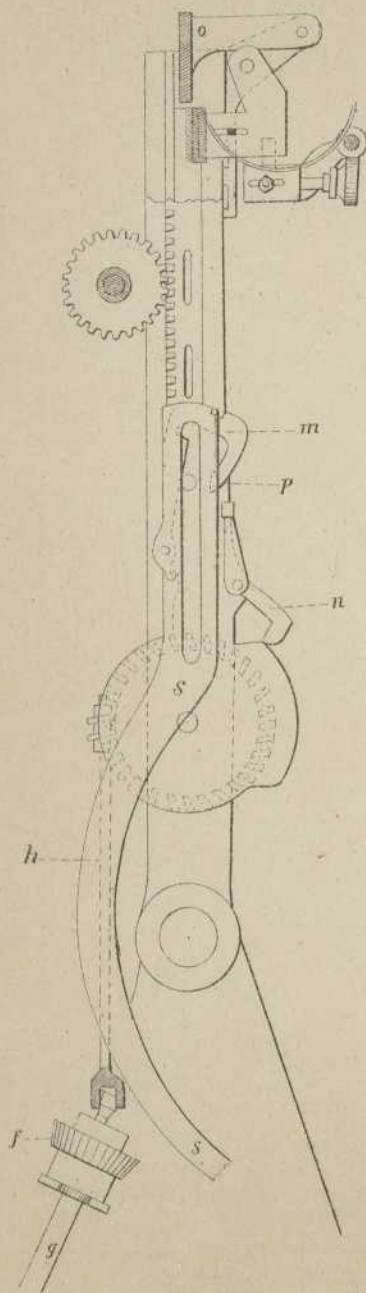


Fig. 322.

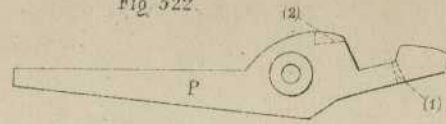


Fig. 324.

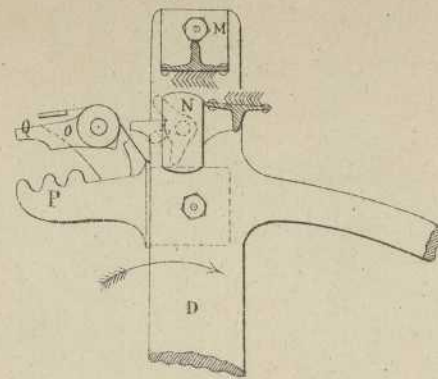


Fig. 325.

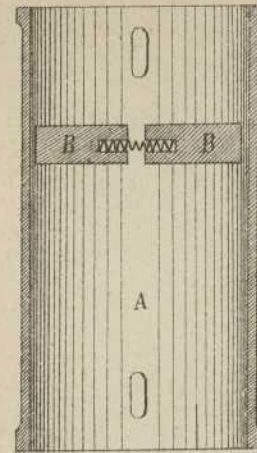


Fig. 319.

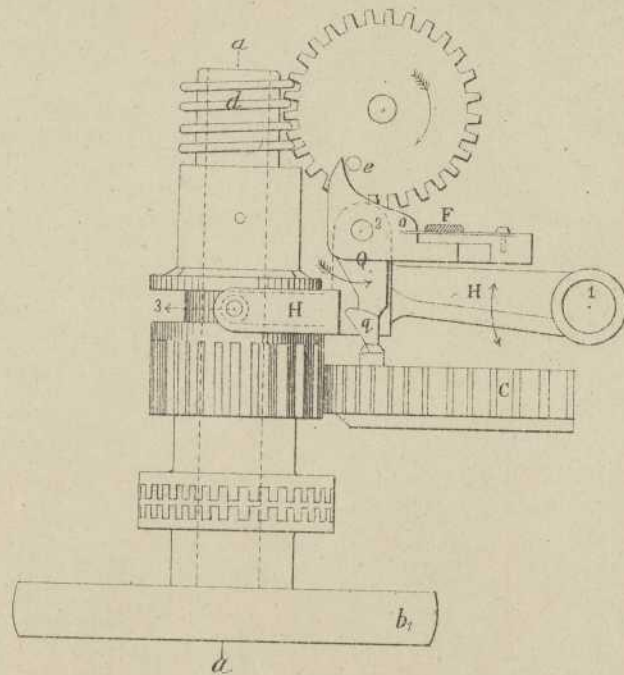


Fig. 323.

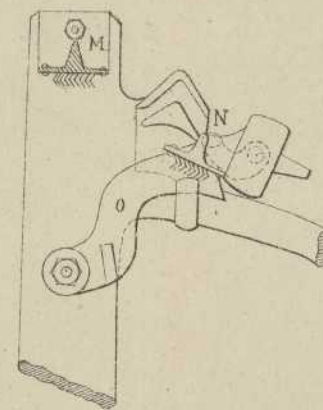


Fig. 326.

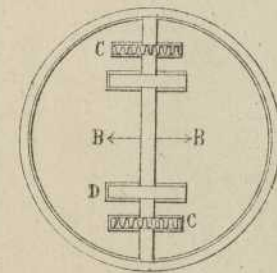


Fig. 318.

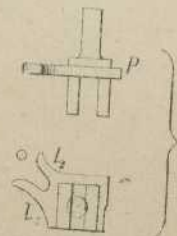


Fig. 320.

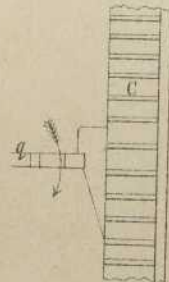
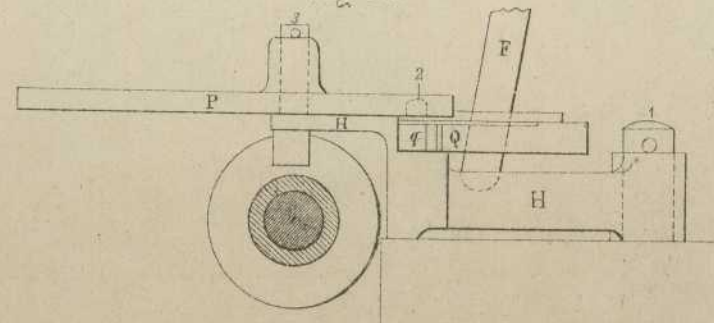


Fig. 321.



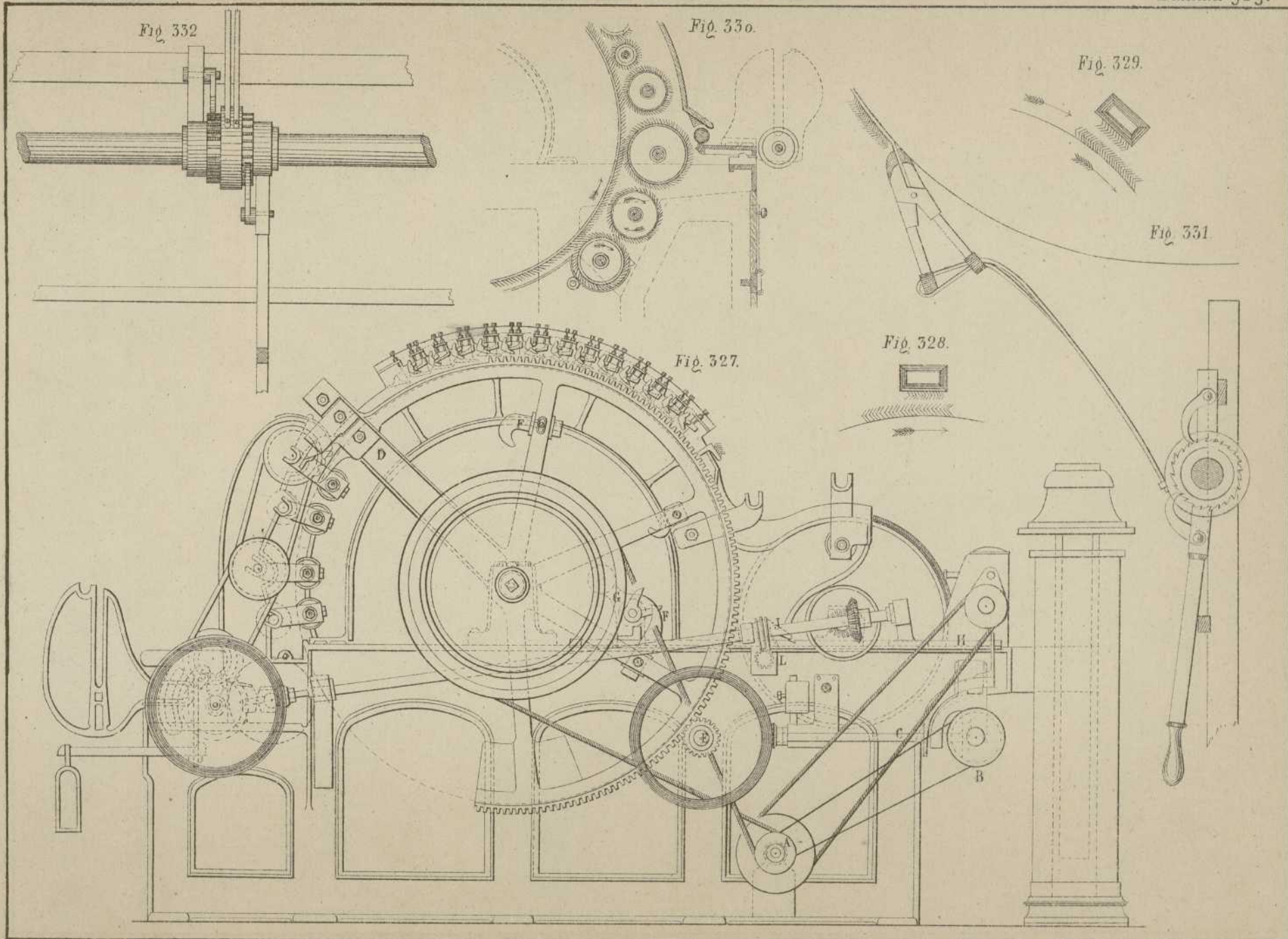


Fig. 333.

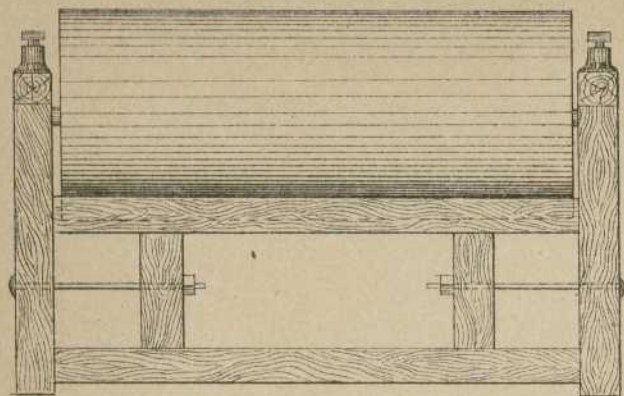


Fig. 334.

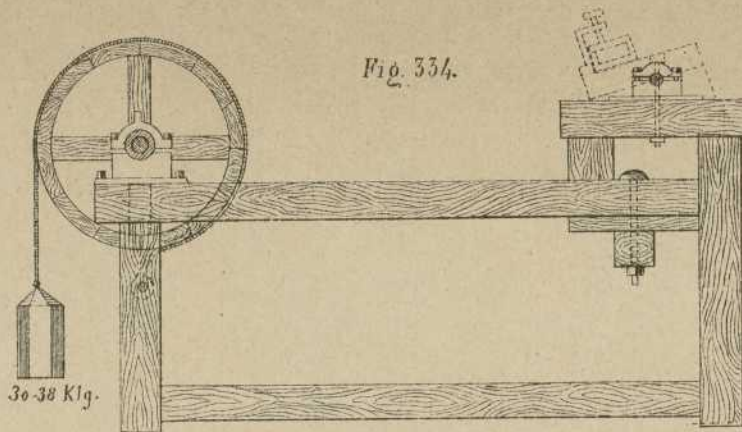


Fig. 341.

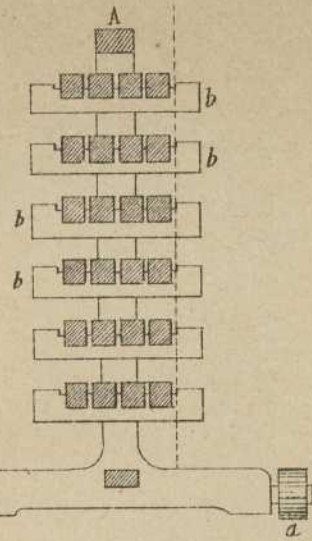


Fig. 338.

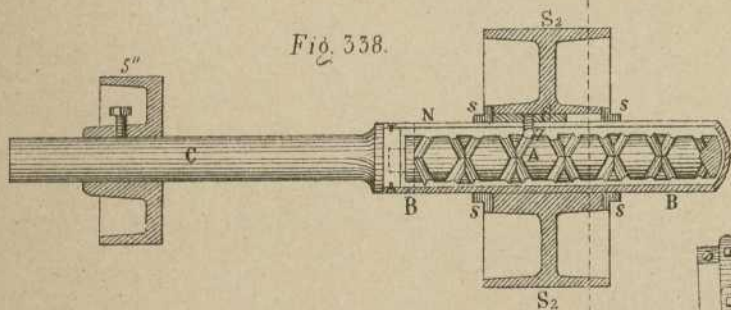


Fig. 335.

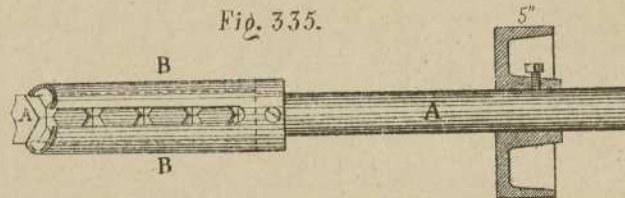


Fig. 342.

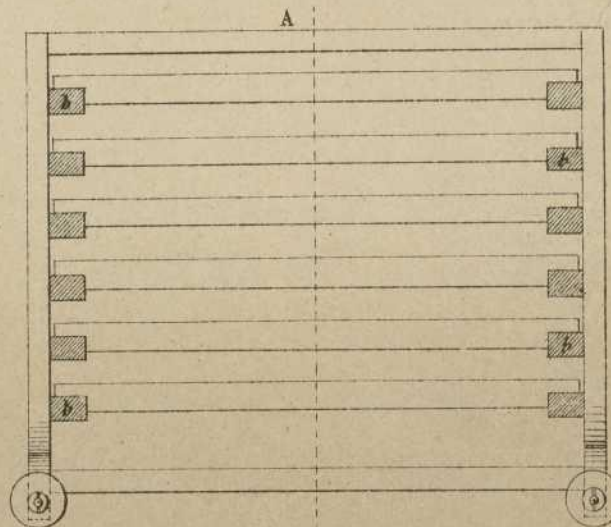


Fig. 337.

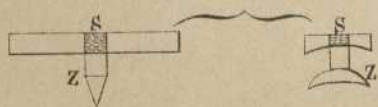


Fig. 339.

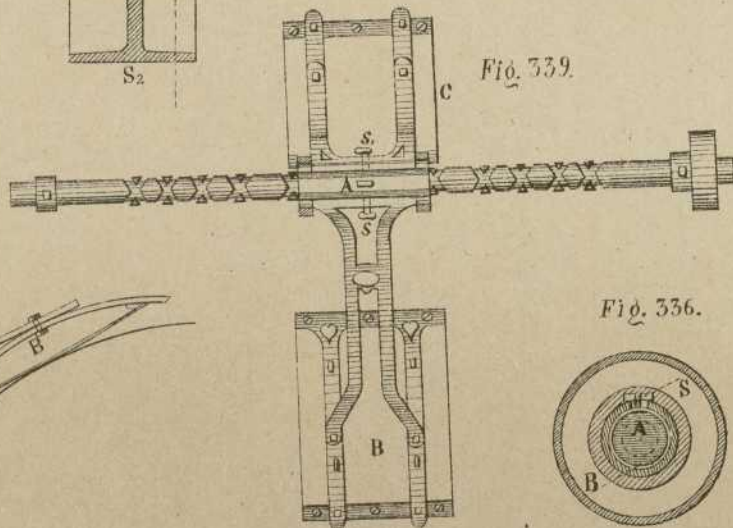


Fig. 340.

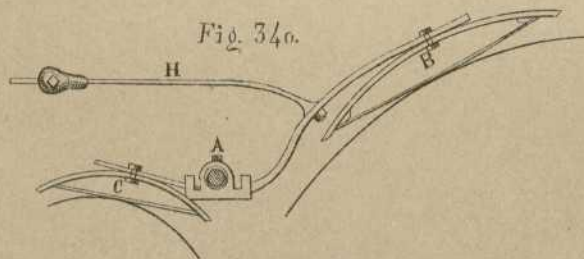


Fig. 336.



Fig. 344.

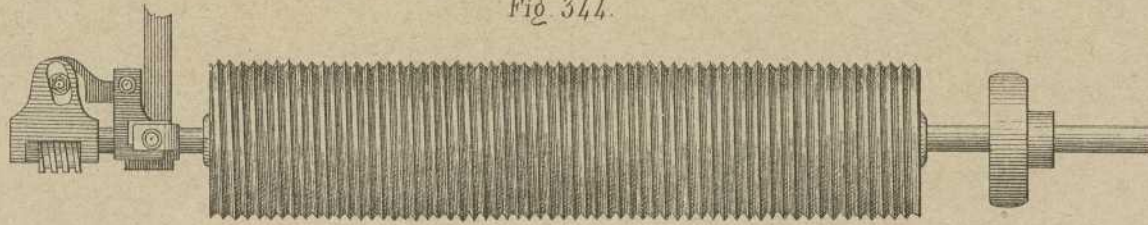


Fig. 351.

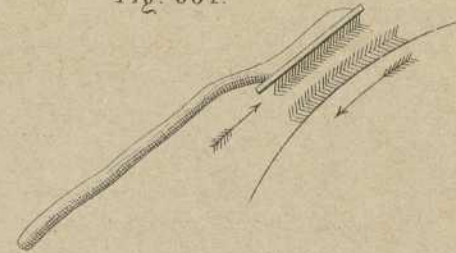


Fig. 343.

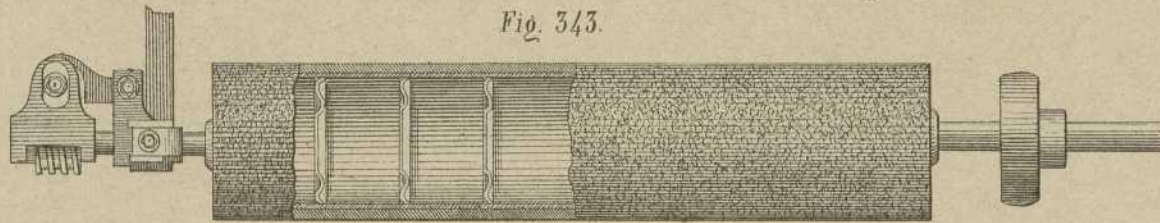


Fig. 345.



Fig. 349.

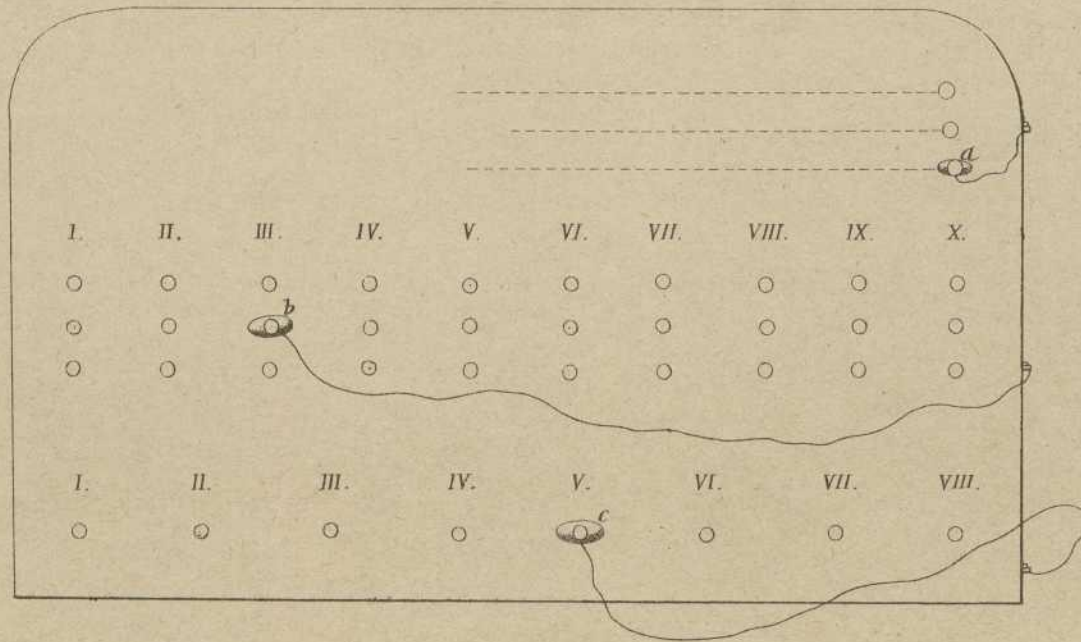


Fig. 348.

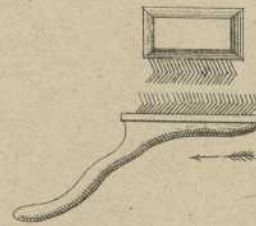


Fig. 350.

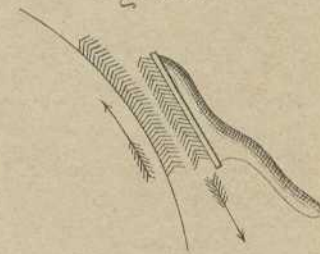


Fig. 346.

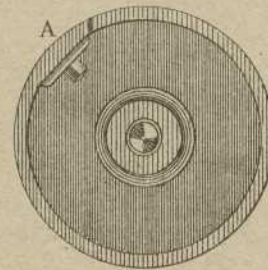


Fig. 347.

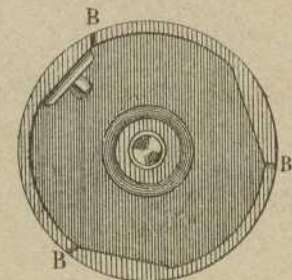


Fig. 352.

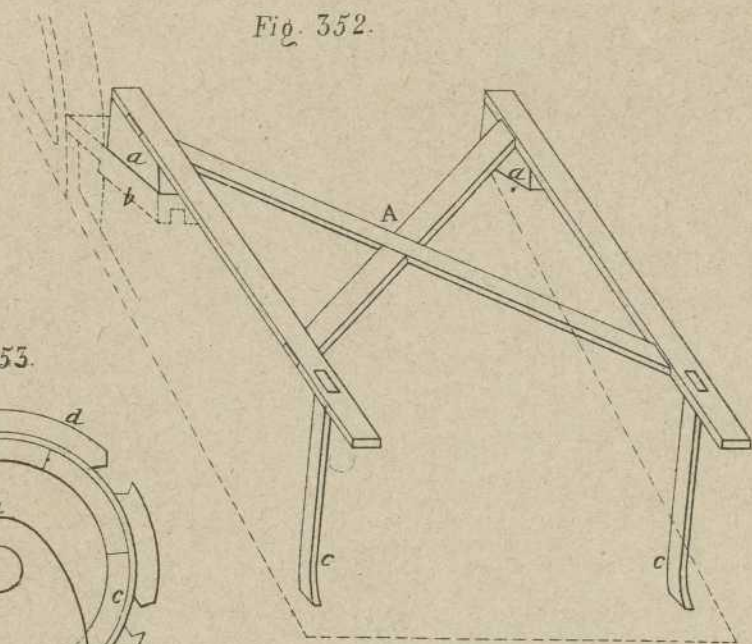


Fig. 356.

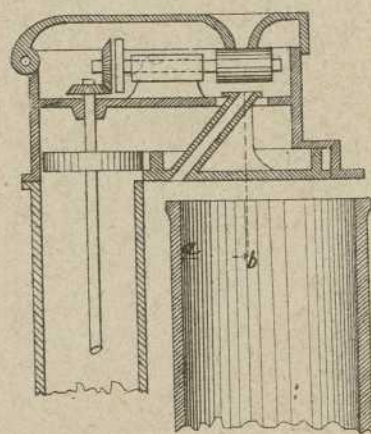


Fig. 353.

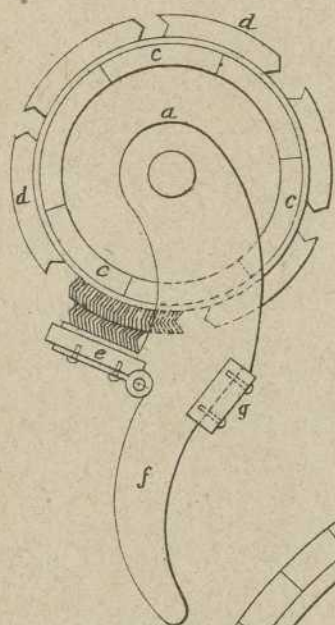


Fig. 355.

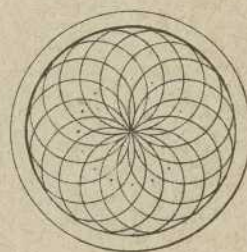
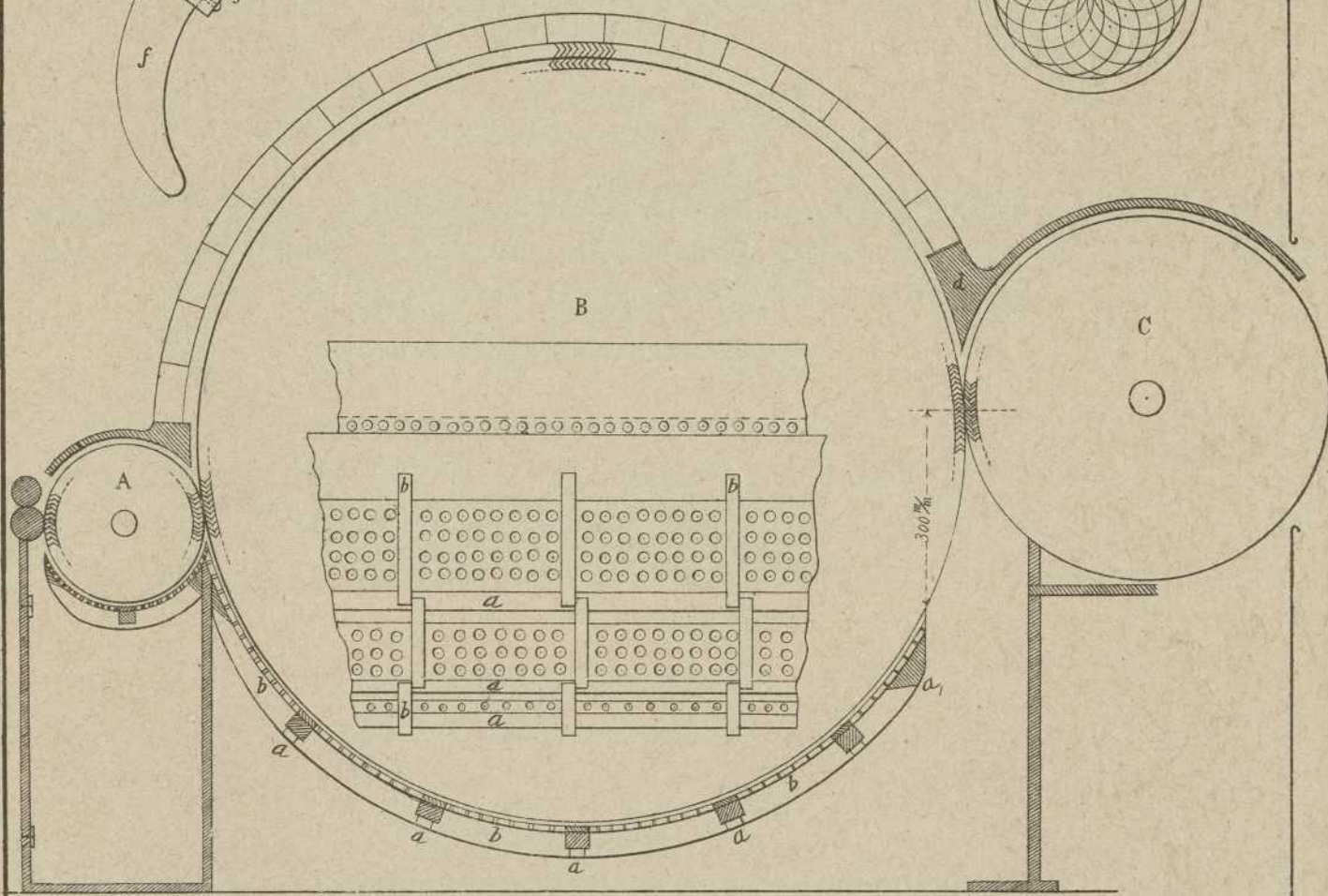


Fig. 354.



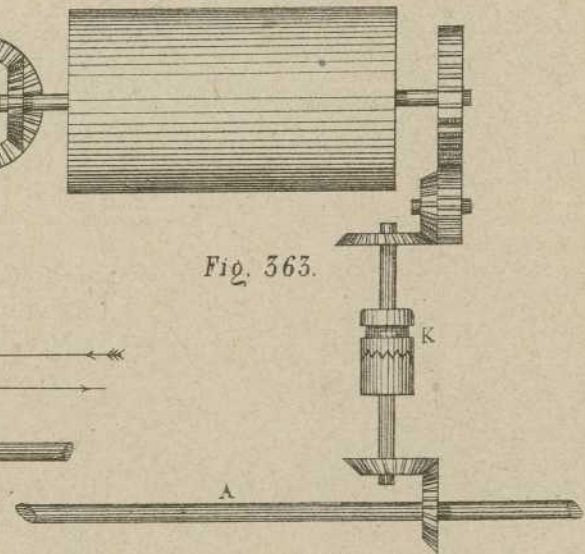
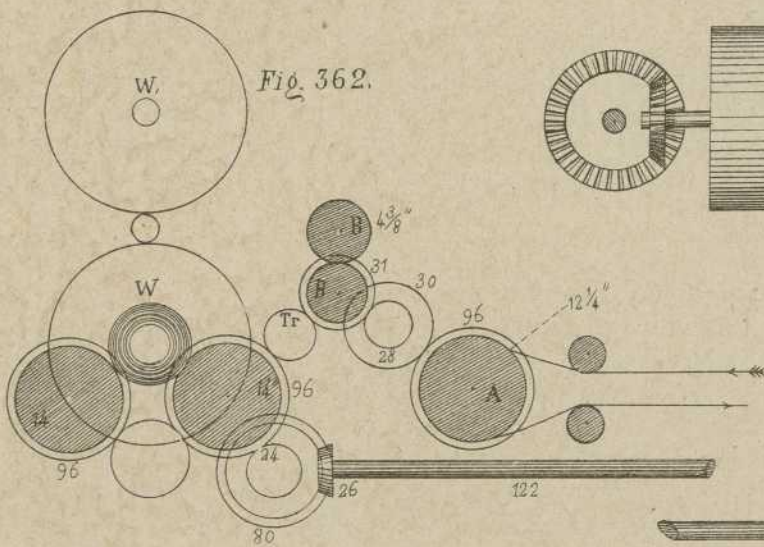
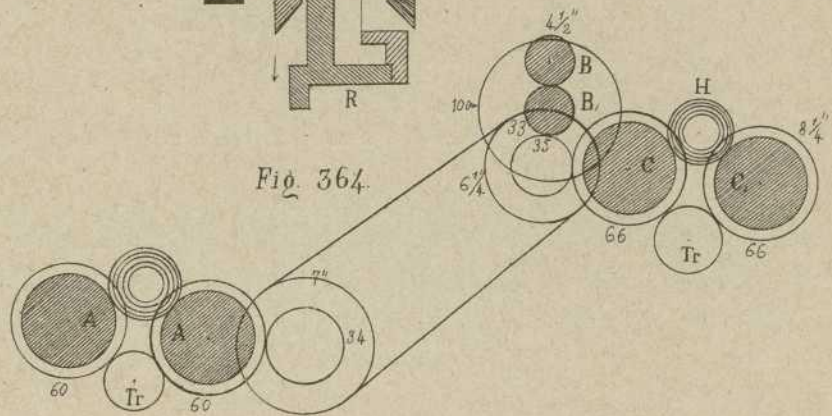
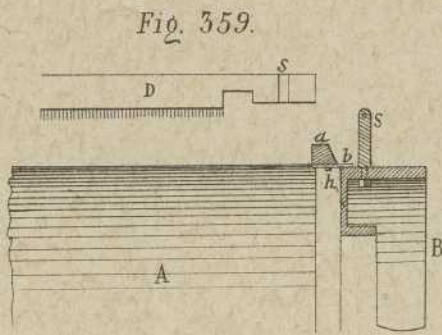
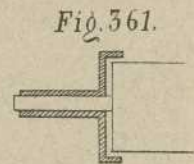
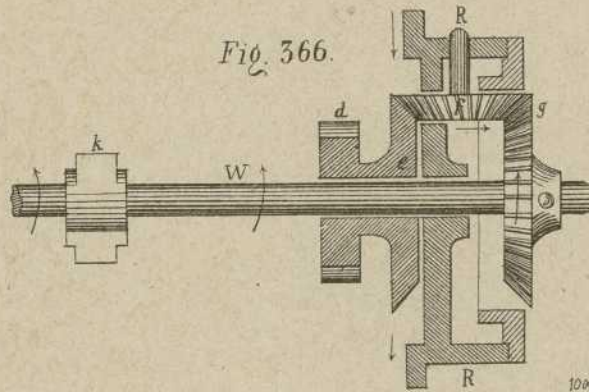
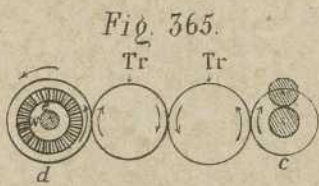
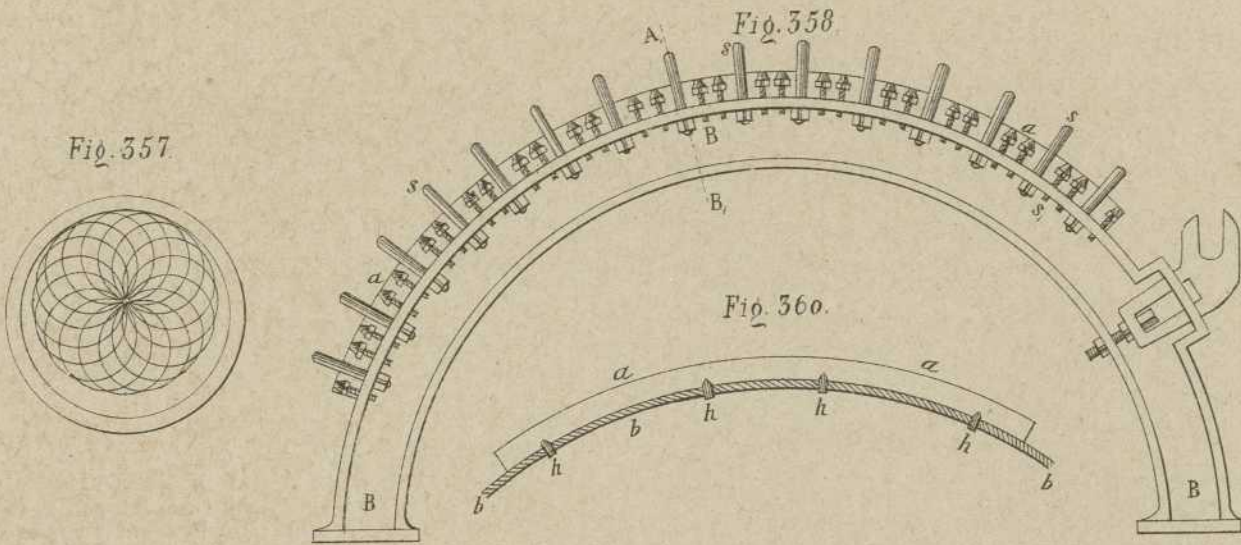


Fig. 372.

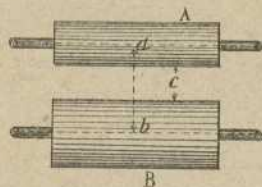


Fig. 375

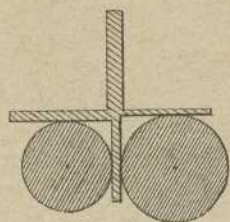


Fig. 376.

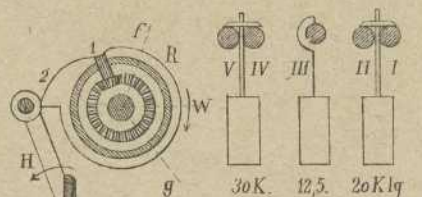


Fig. 370.

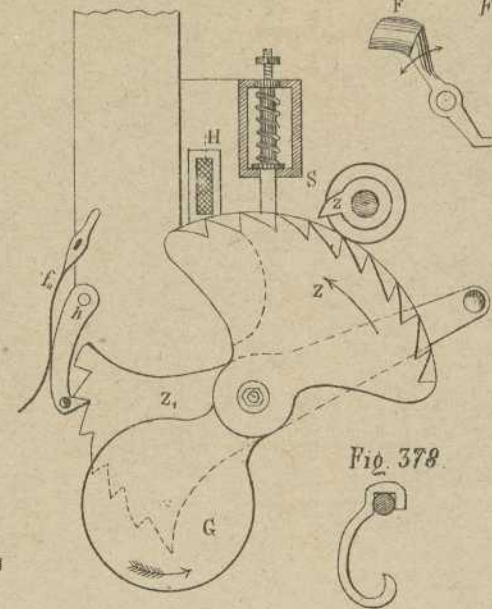


Fig. 368.

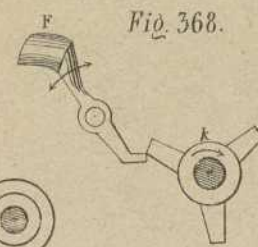


Fig. 367.

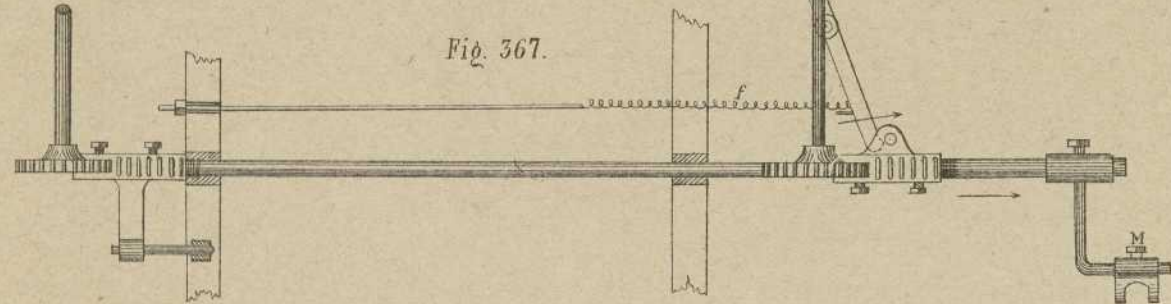


Fig. 378.

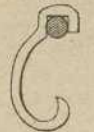


Fig. 379.



Fig. 373.

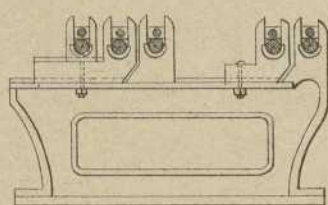


Fig. 374.

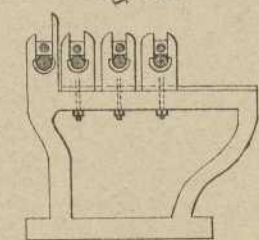


Fig. 377.

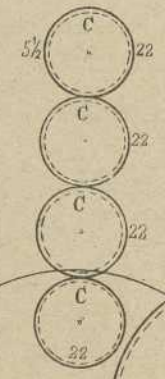
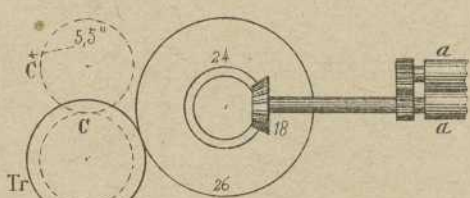
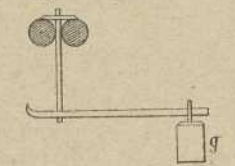


Fig. 371.

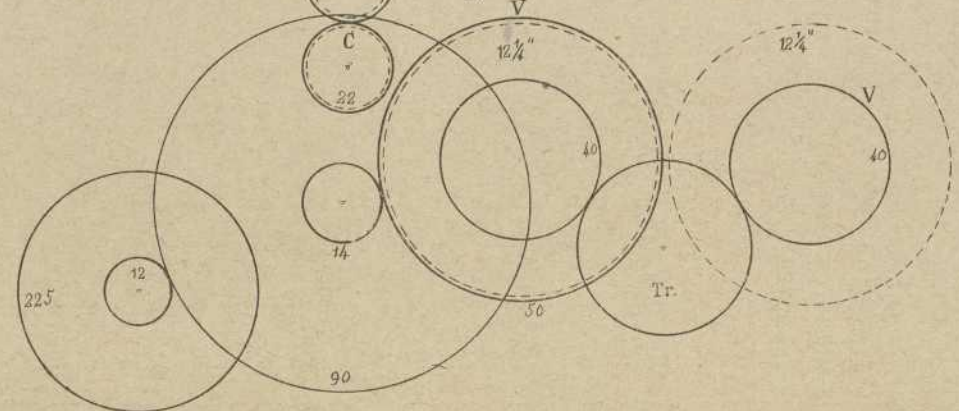


Fig. 369.

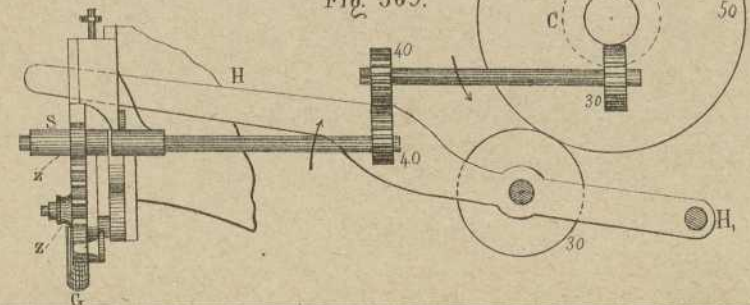


Fig. 385.

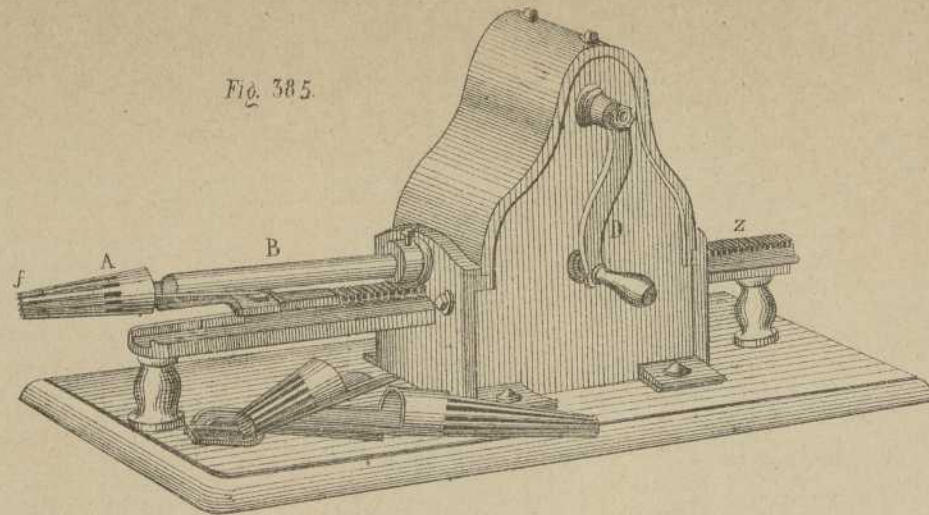


Fig. 383.

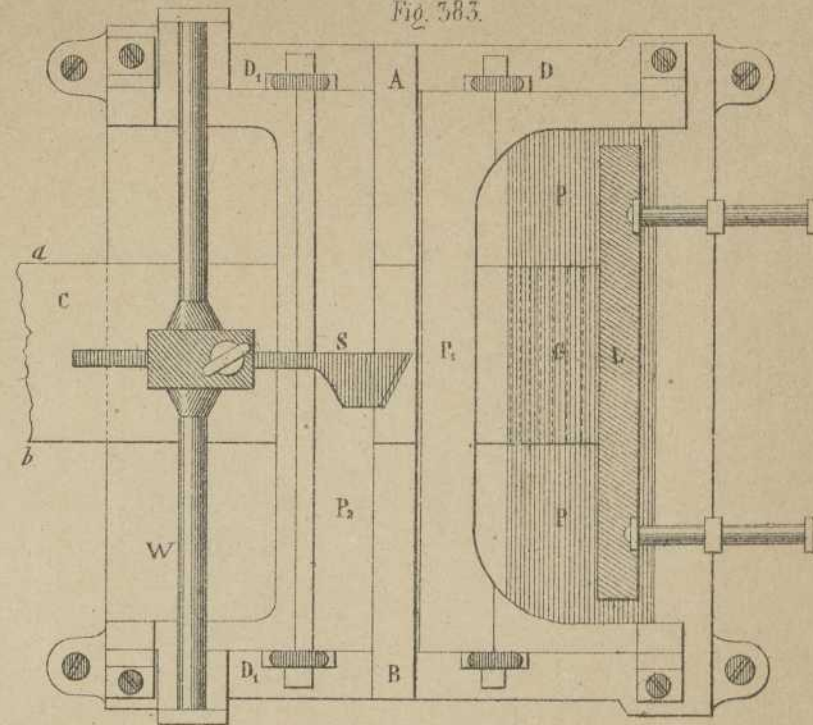


Fig. 381.

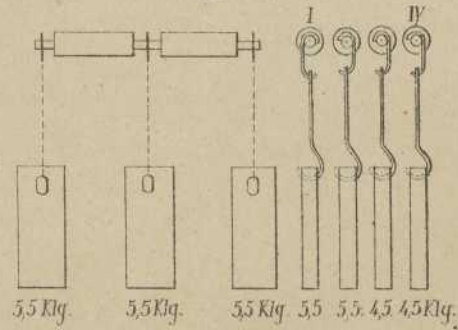


Fig. 386.

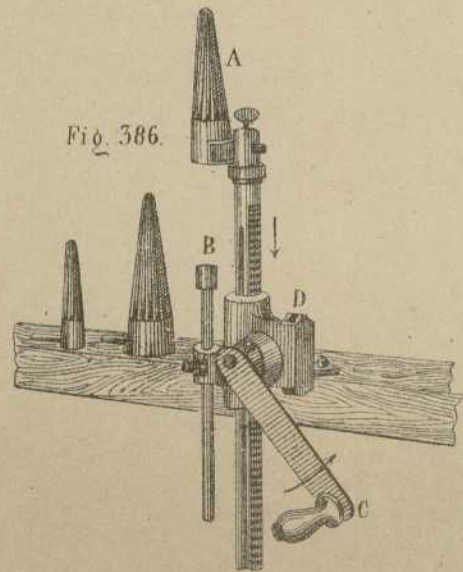


Fig. 384.

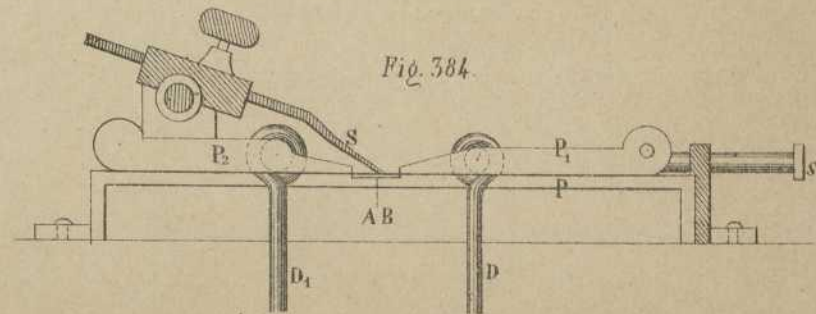


Fig. 380.



Fig. 382.

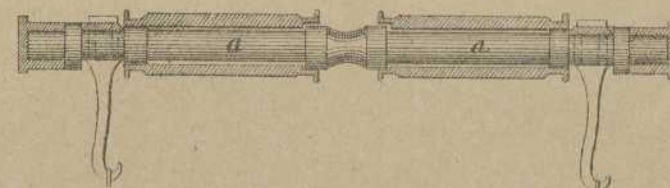


Fig. 387.

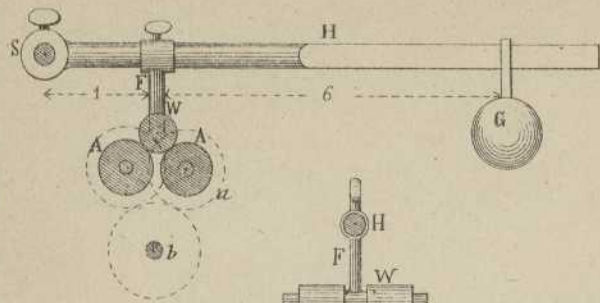


Fig. 393.

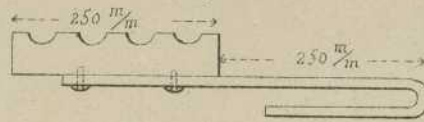


Fig. 388.

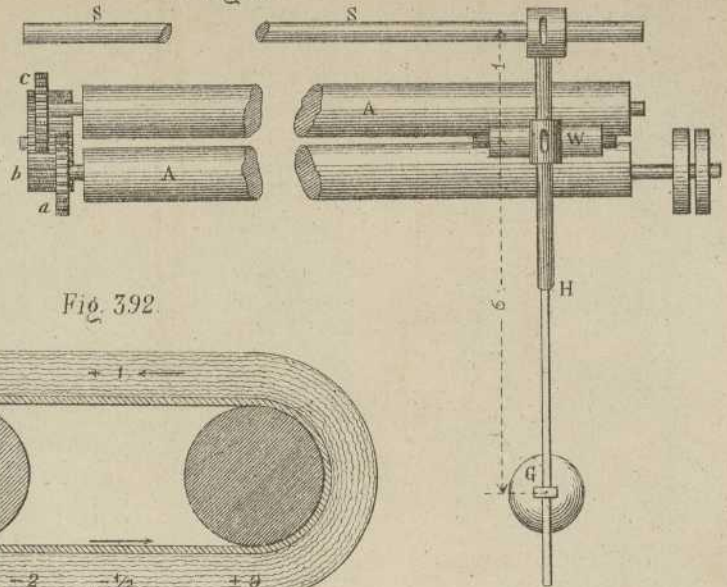


Fig. 390.

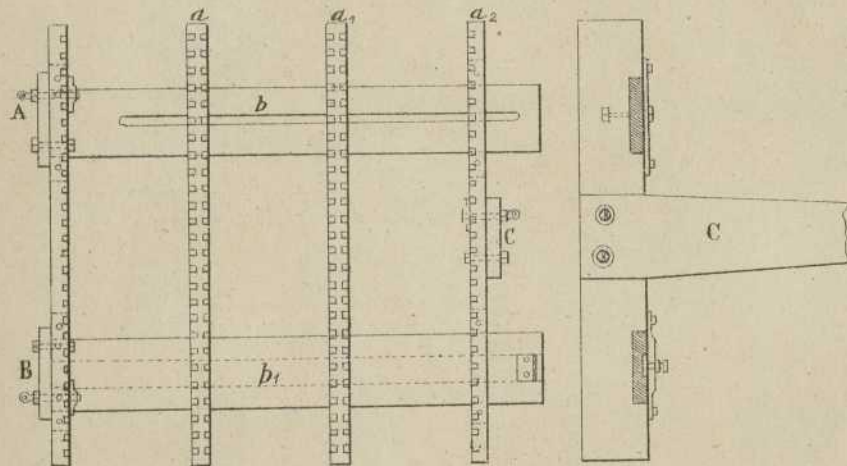


Fig. 392.

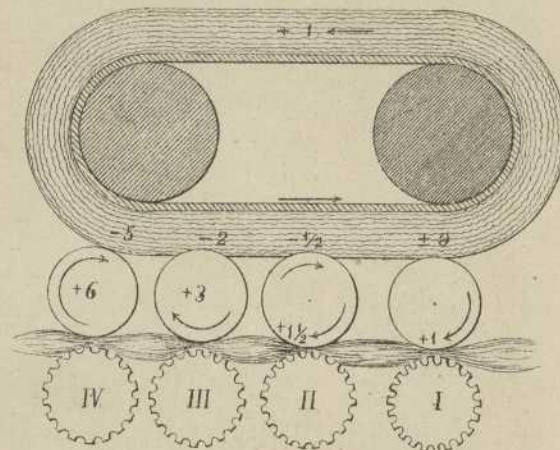


Fig. 394.

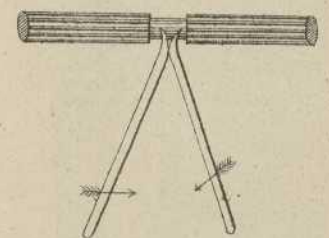


Fig. 389.

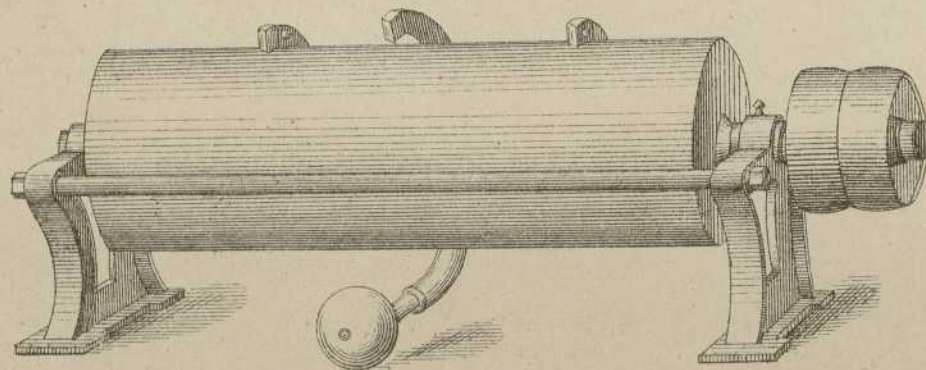


Fig. 391.



Fig. 395.

Fig. 397.

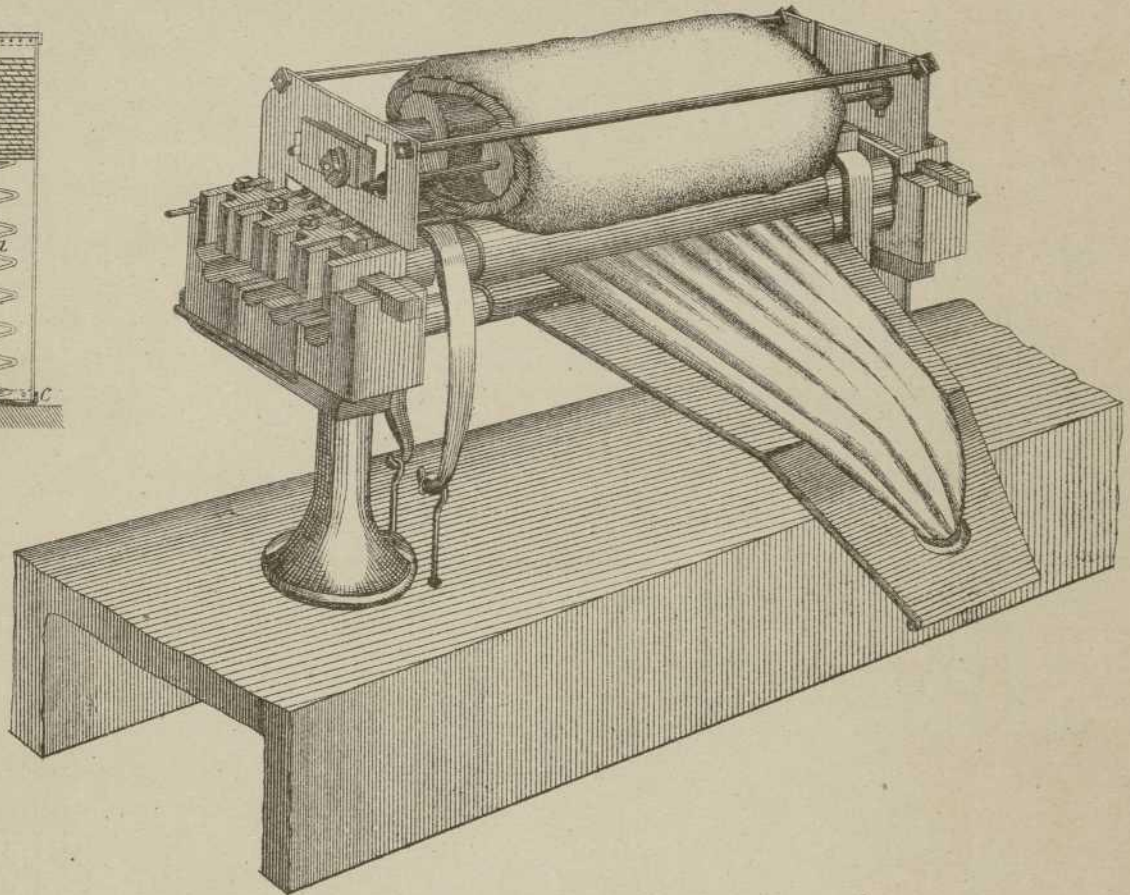
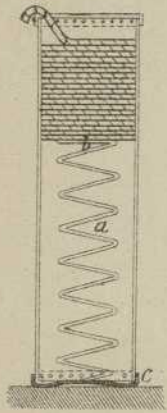


Fig. 396.

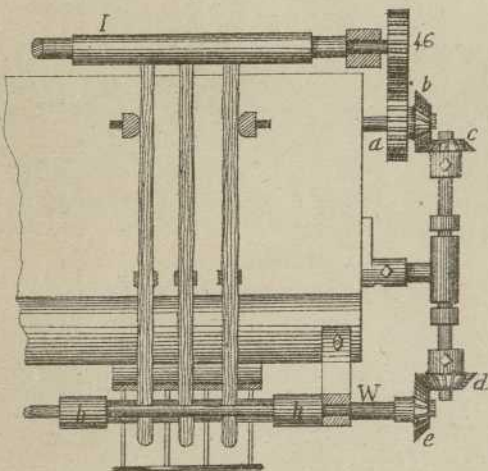


Fig. 398.

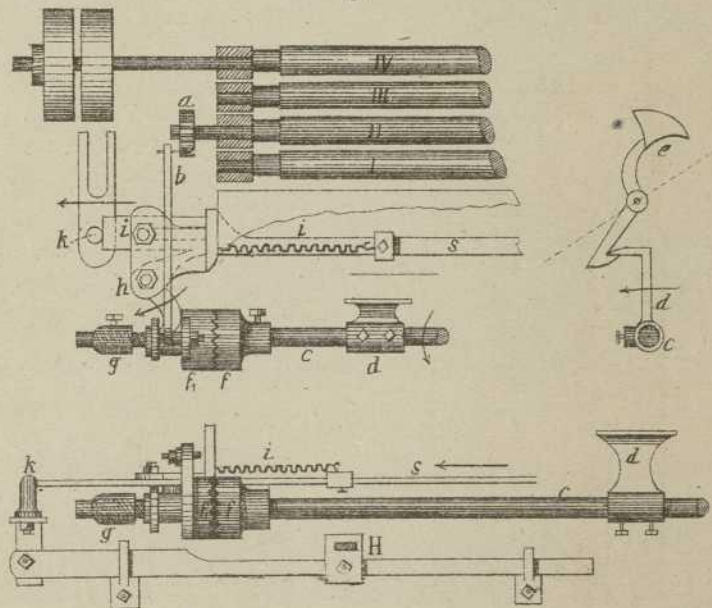


Fig. 399.

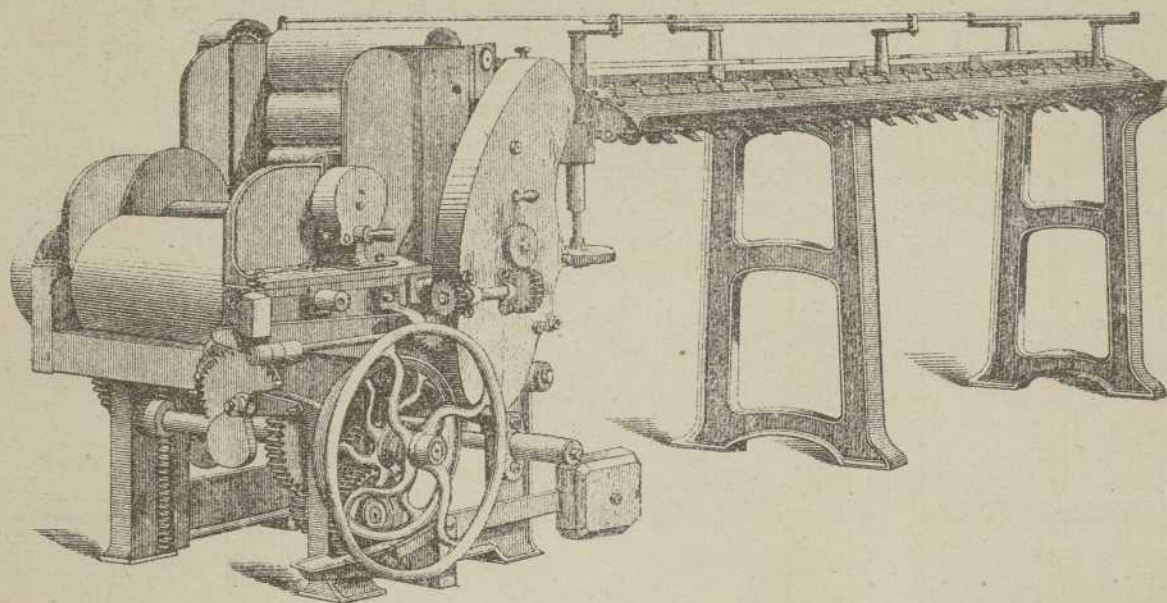


Fig. 400.

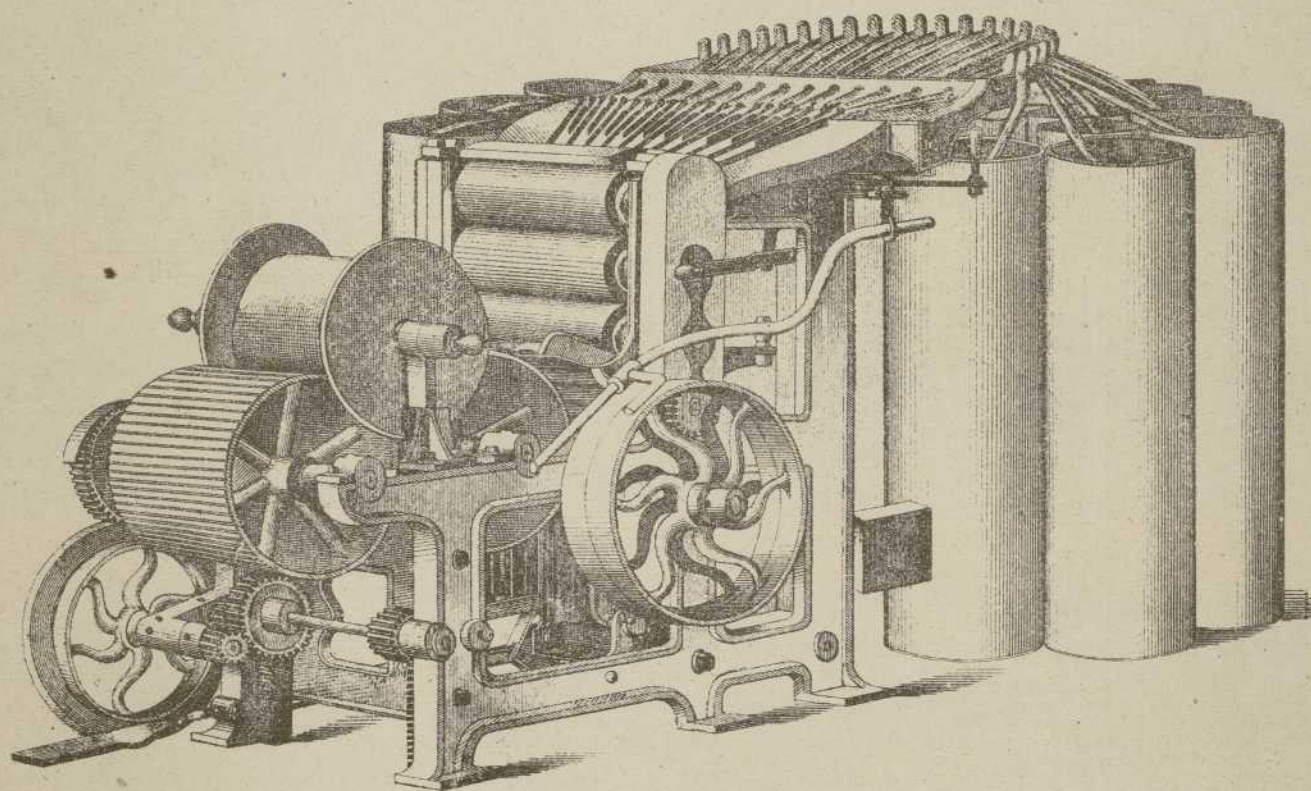


Fig. 401.

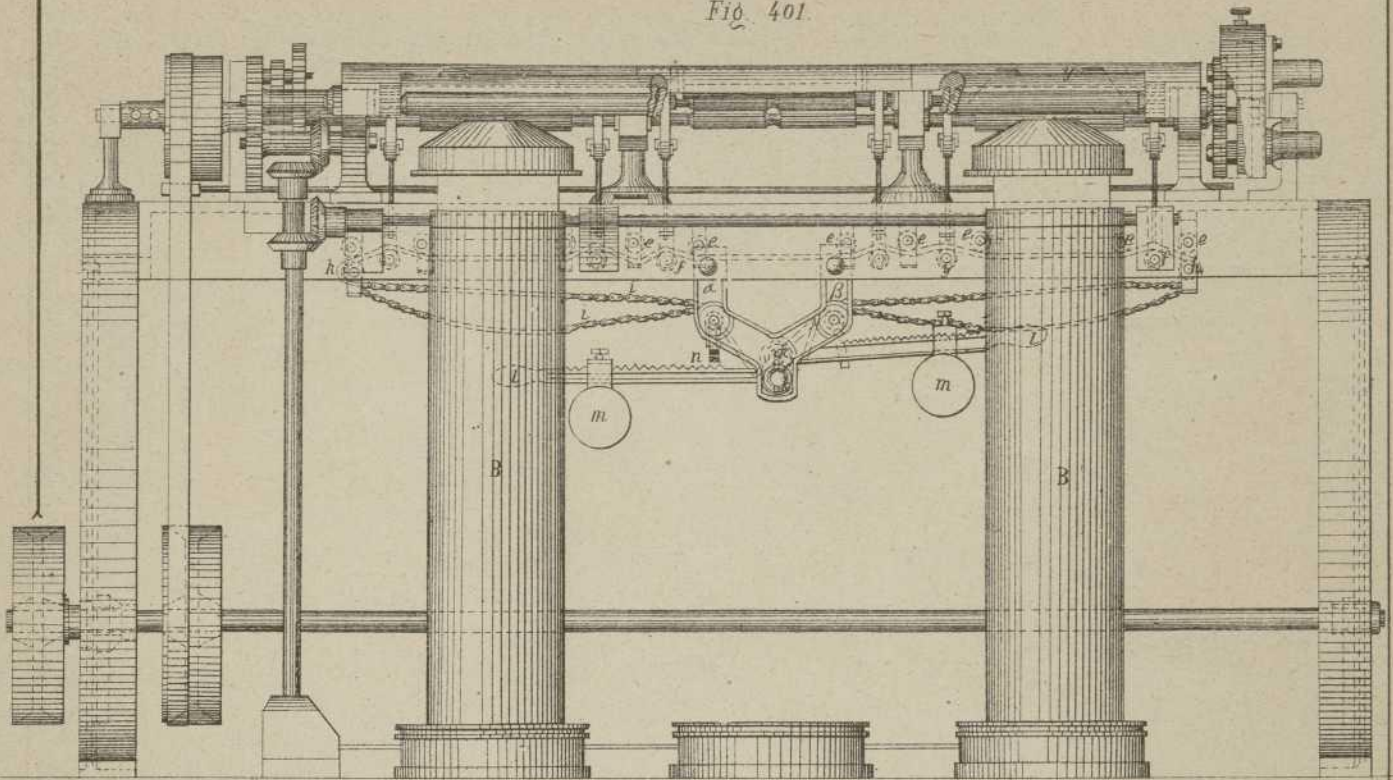


Fig. 402.

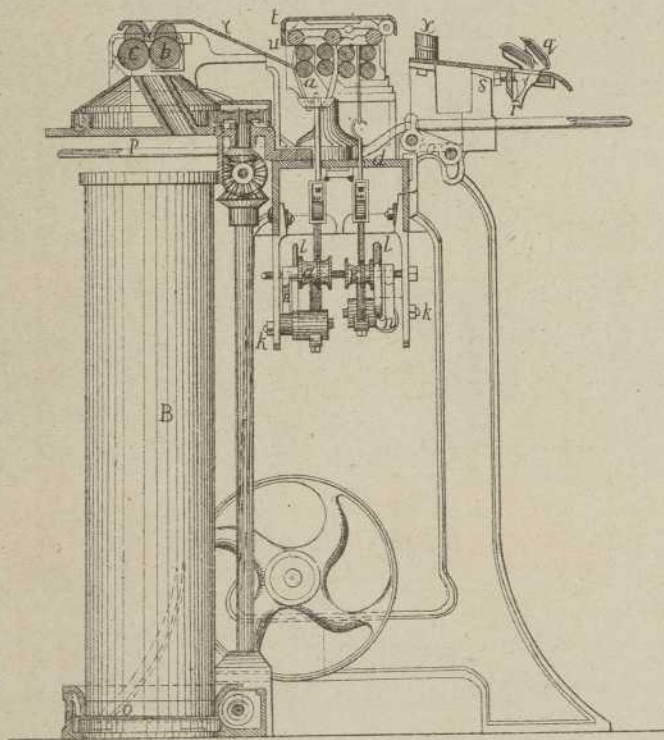


Fig. 403.

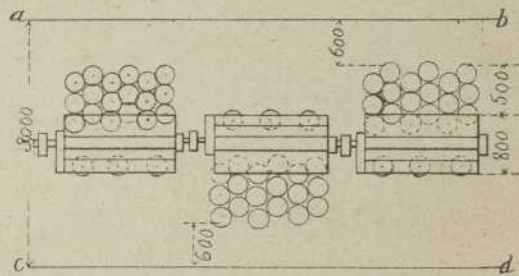
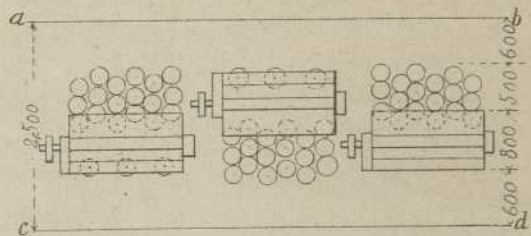


Fig. 404.



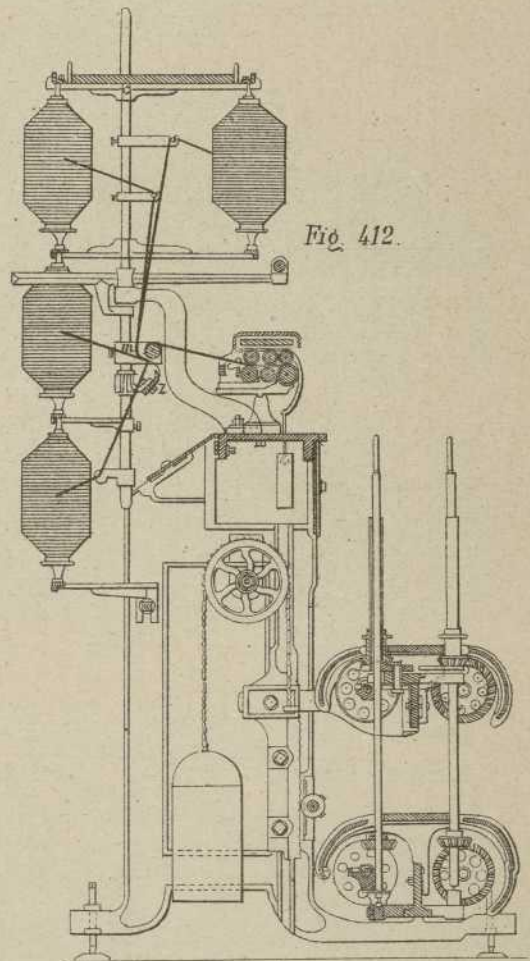
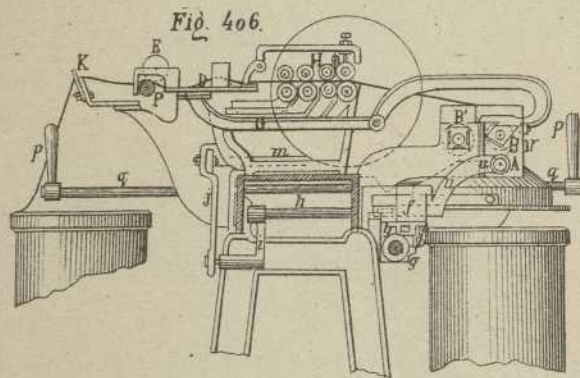
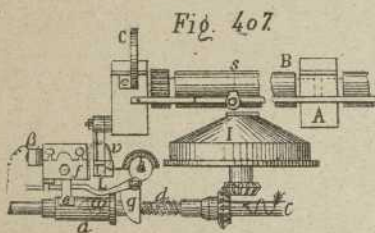
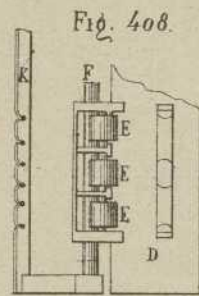
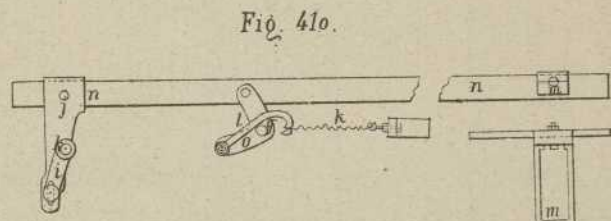
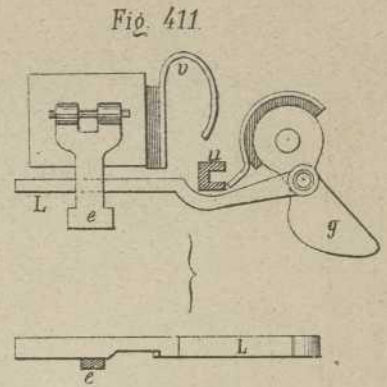
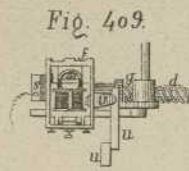
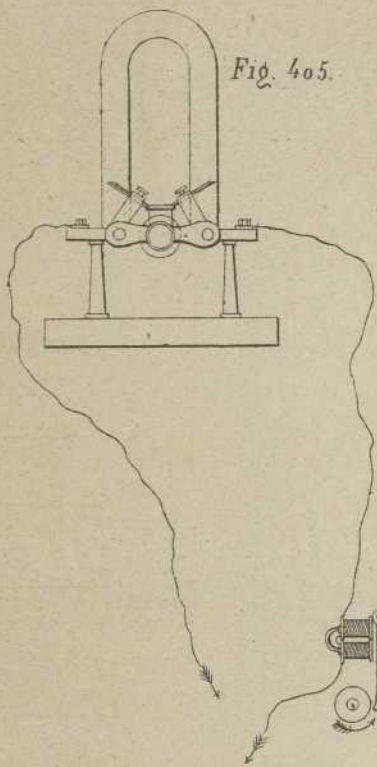


Fig. 413

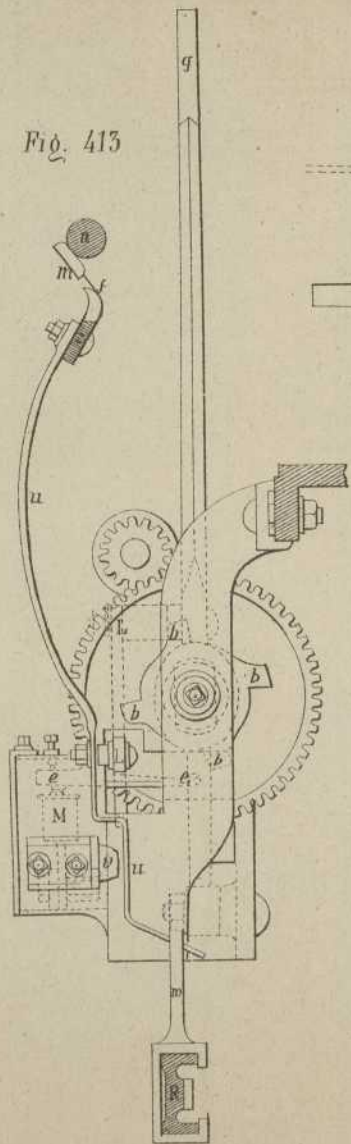


Fig. 414

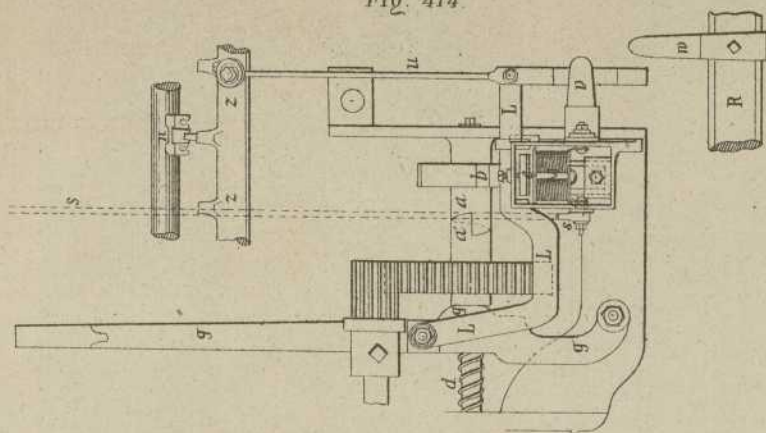


Fig. 415

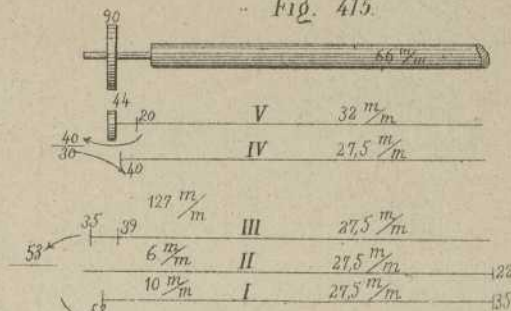


Fig. 421

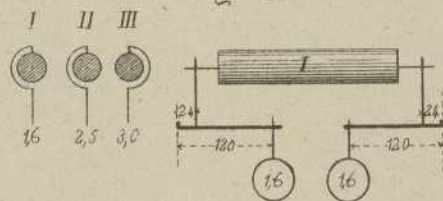


Fig. 417

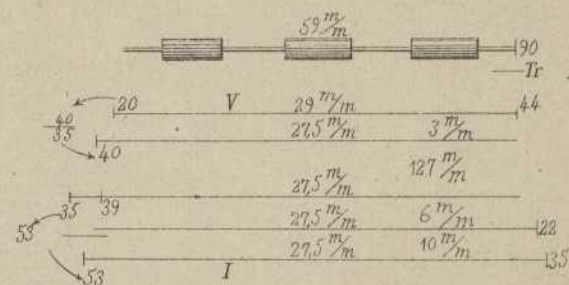


Fig. 420

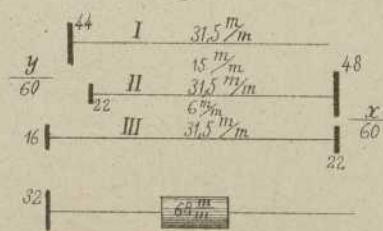


Fig. 418

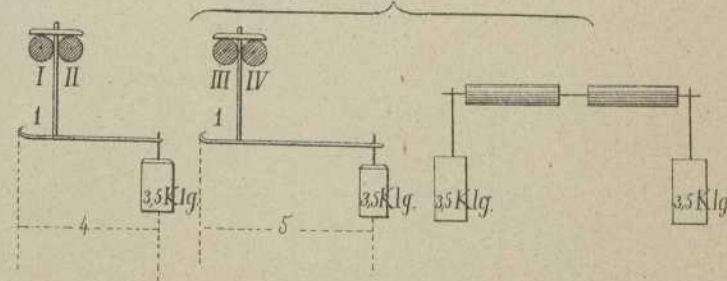


Fig. 419

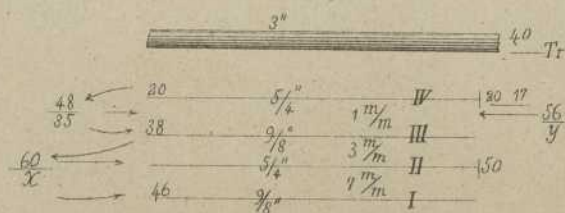
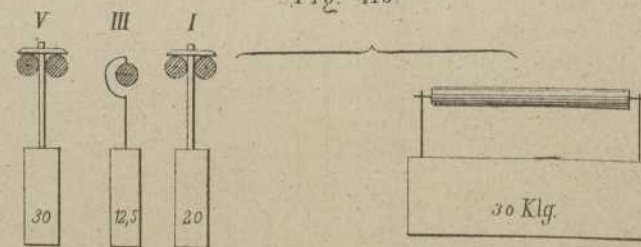


Fig. 416



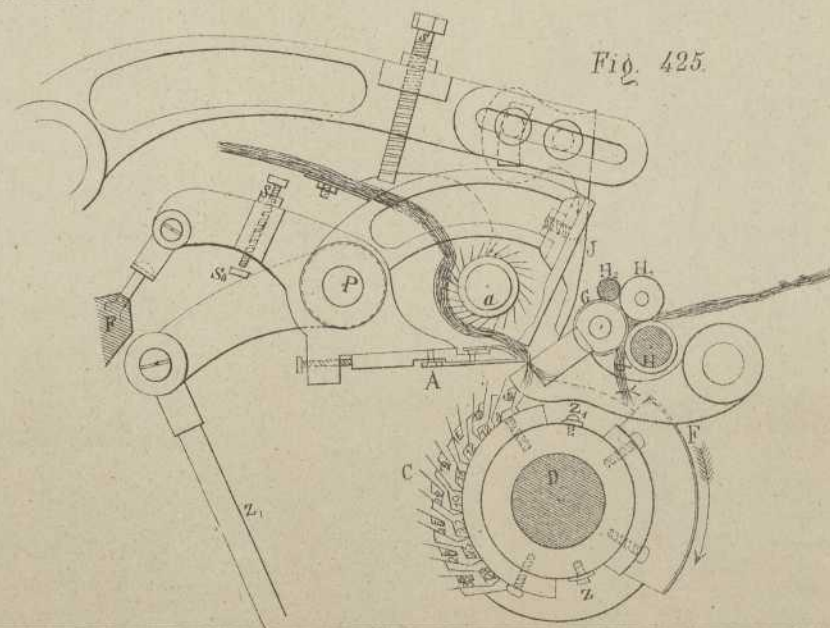
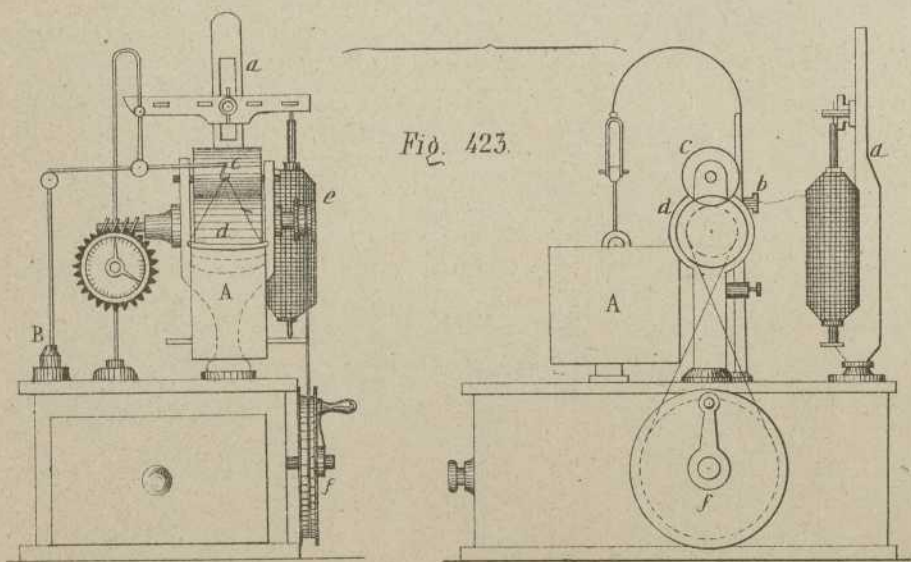
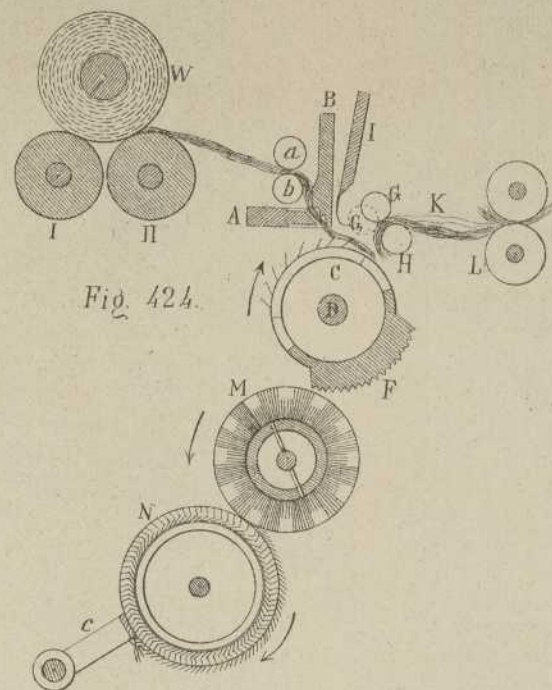
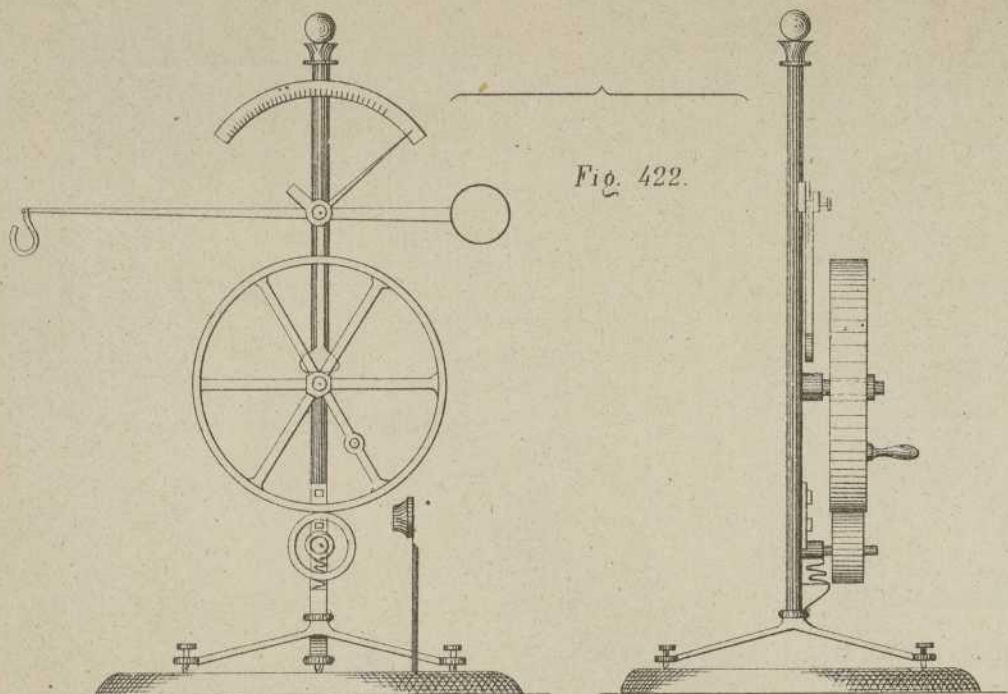
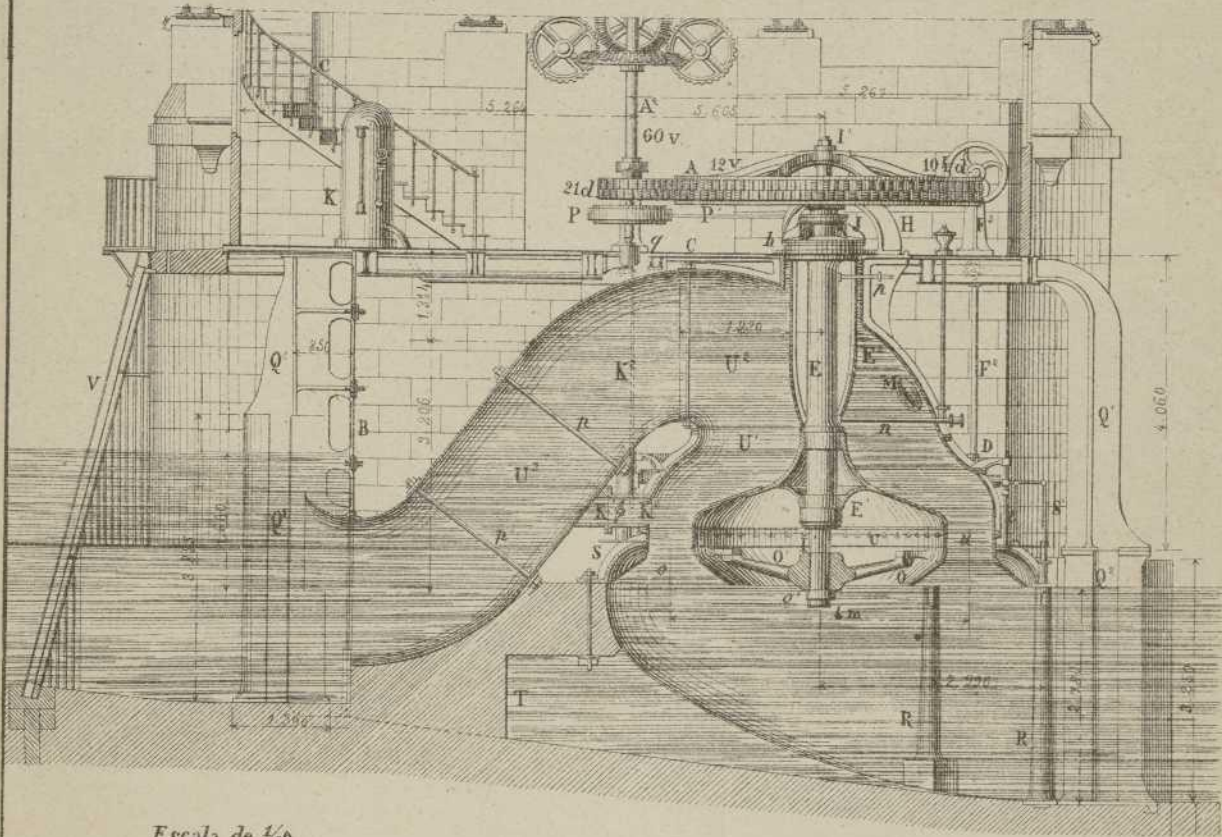
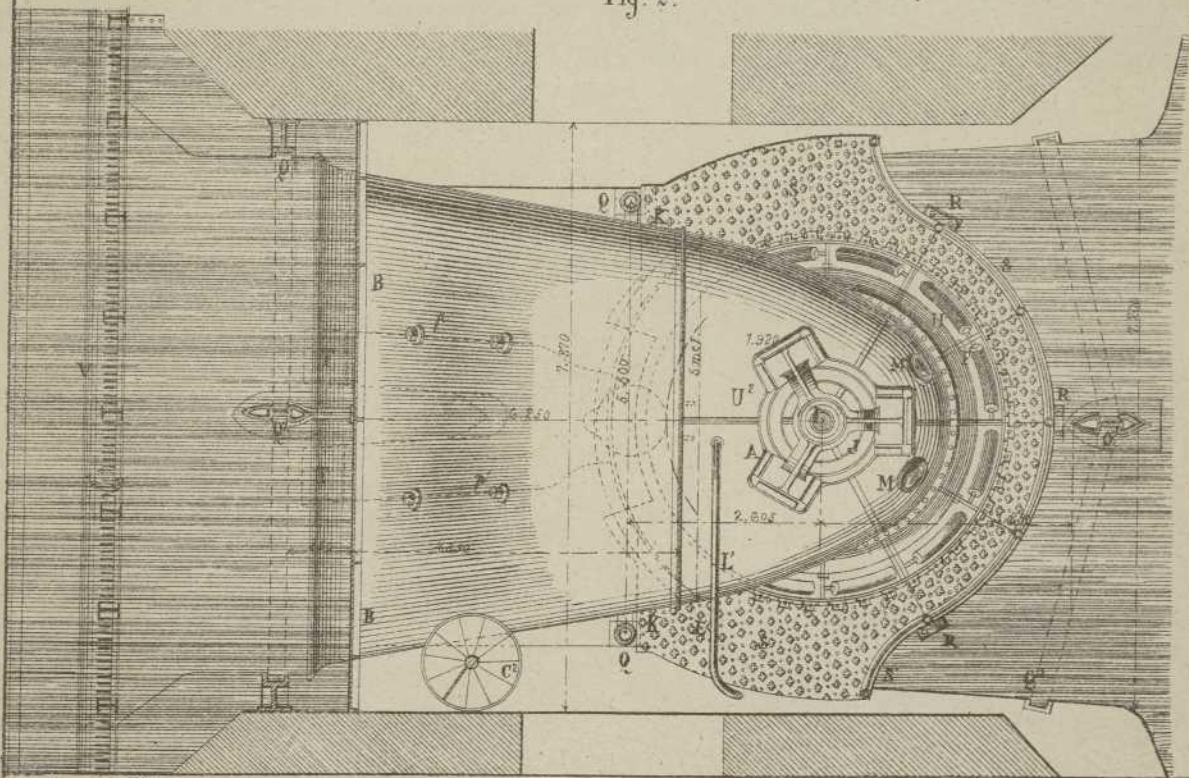


Fig. 1.



Escala de $\frac{1}{100}$.

Fig. 2.



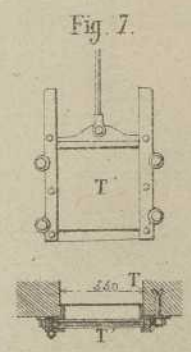
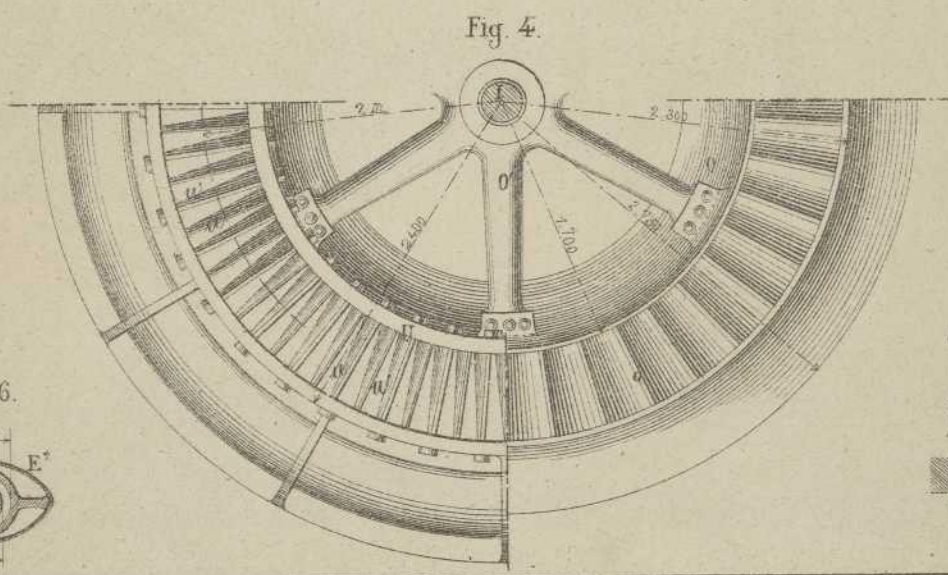
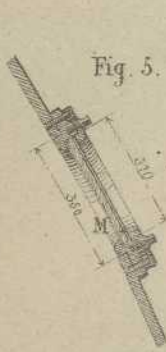
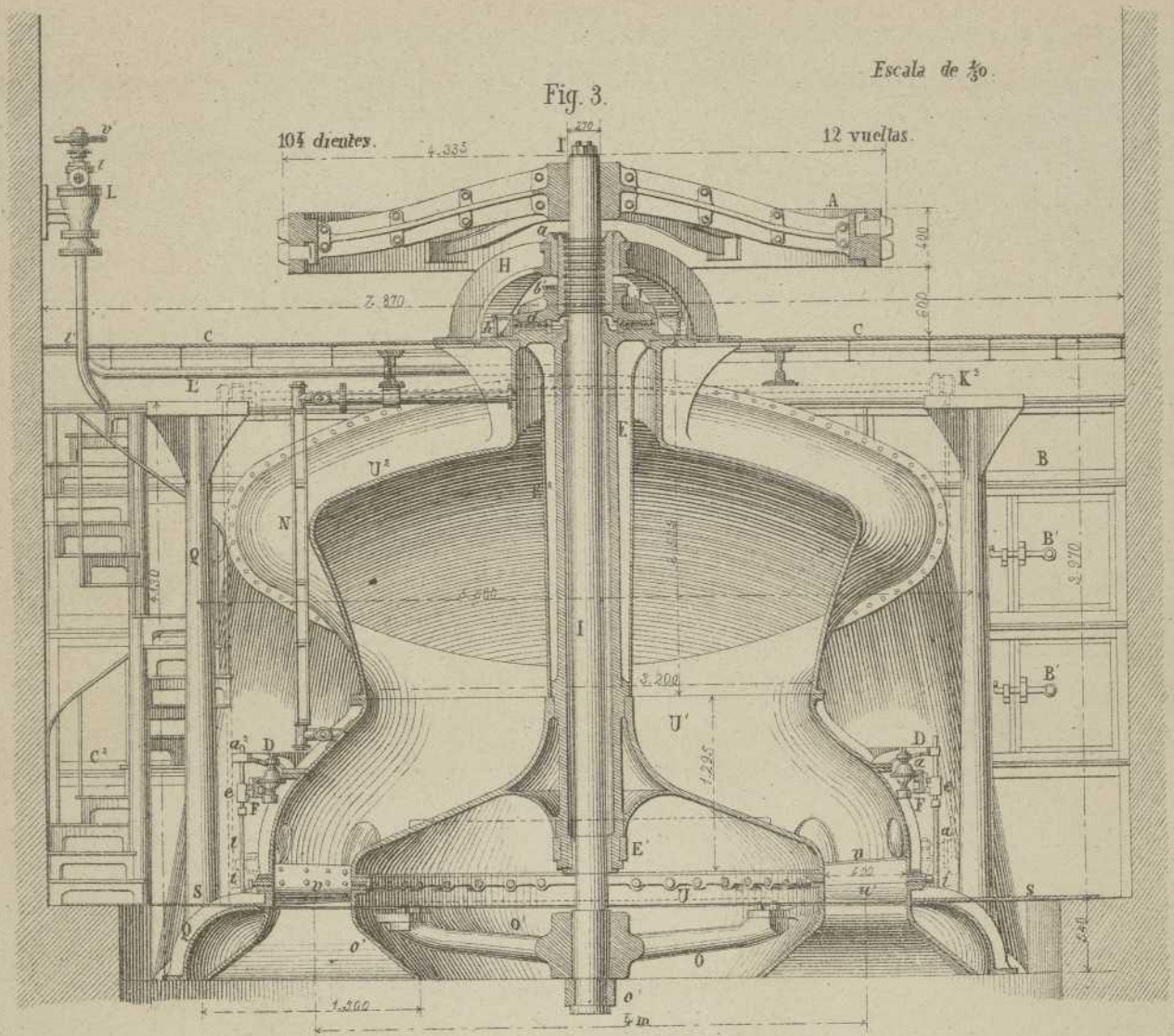


Fig. 19.

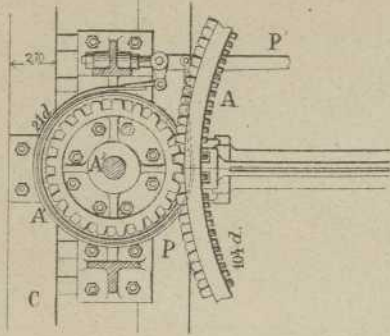


Fig. 8.

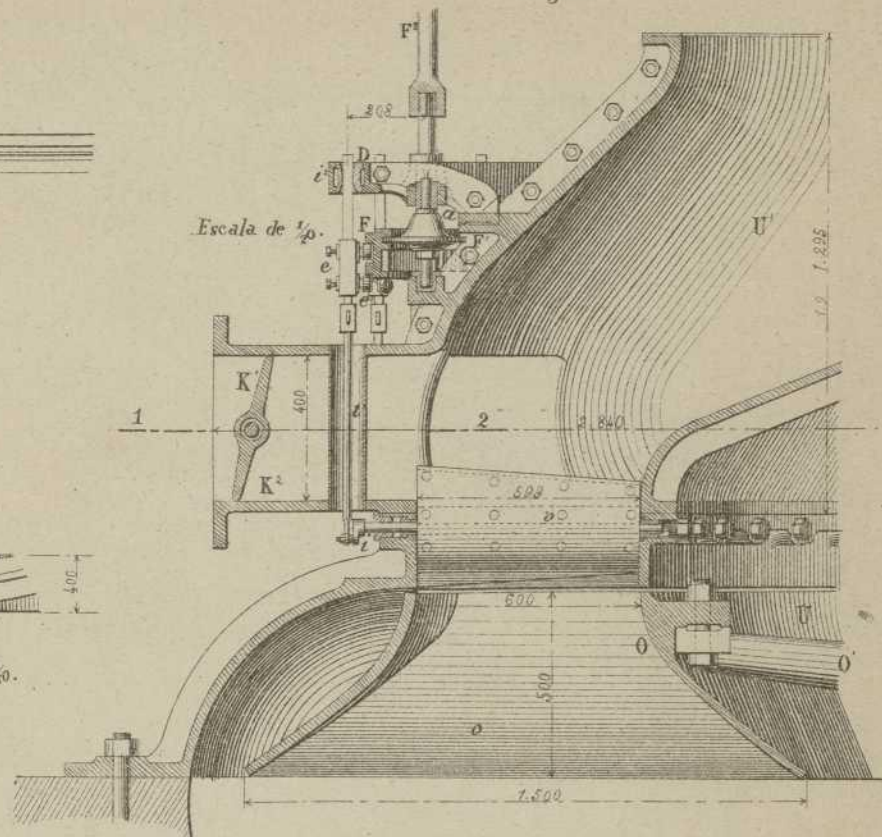


Fig. 18.

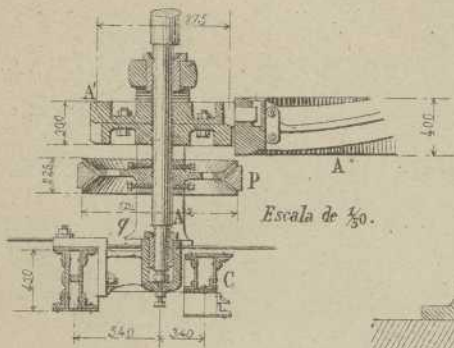


Fig. 9.

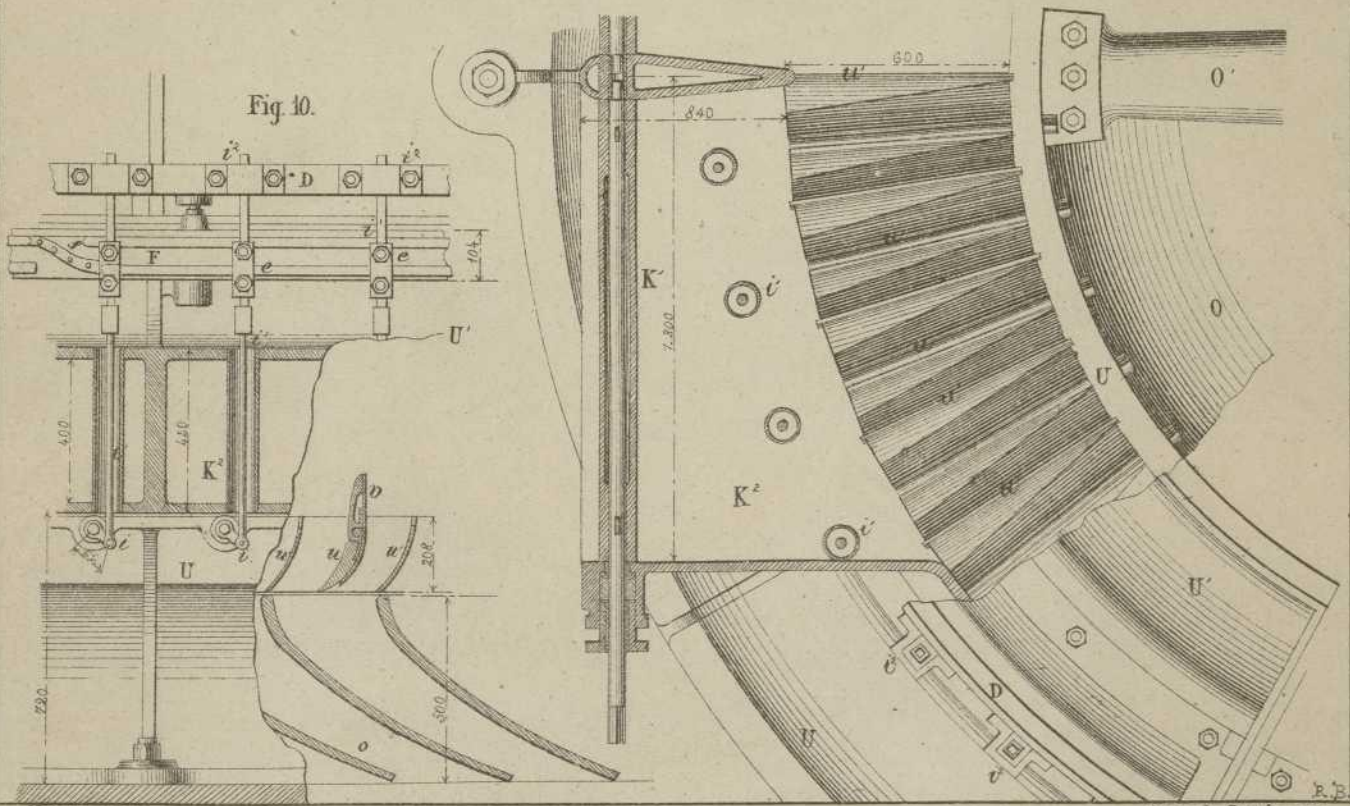
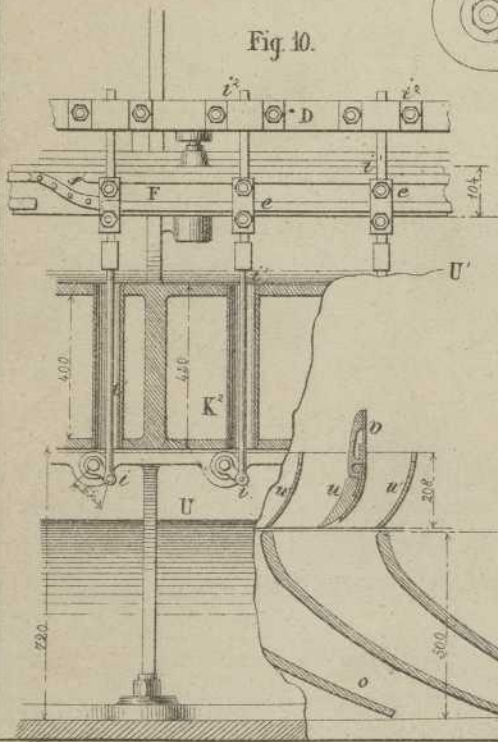
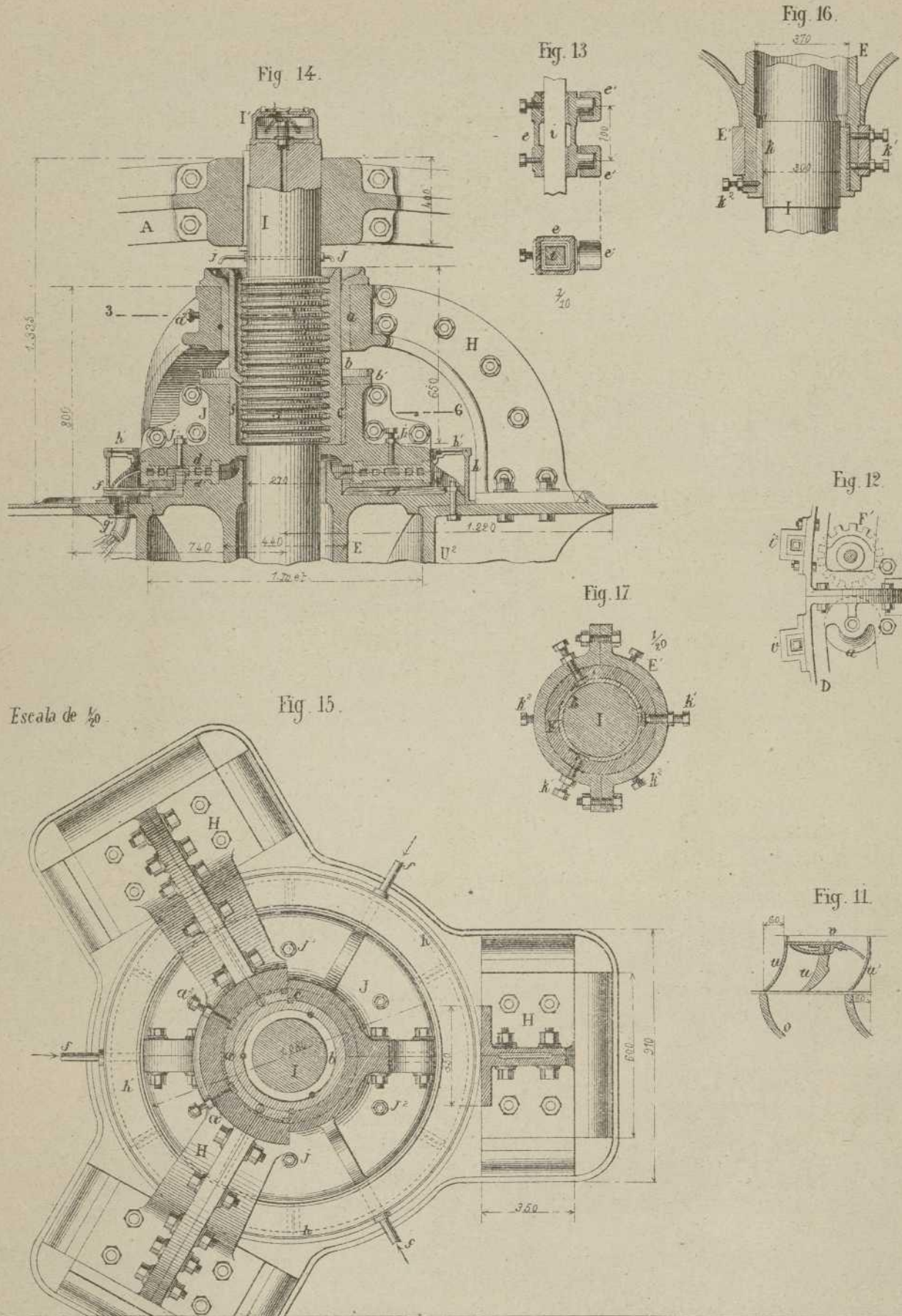


Fig. 10.





Escala de $\frac{1}{20}$.

Fig. 1.

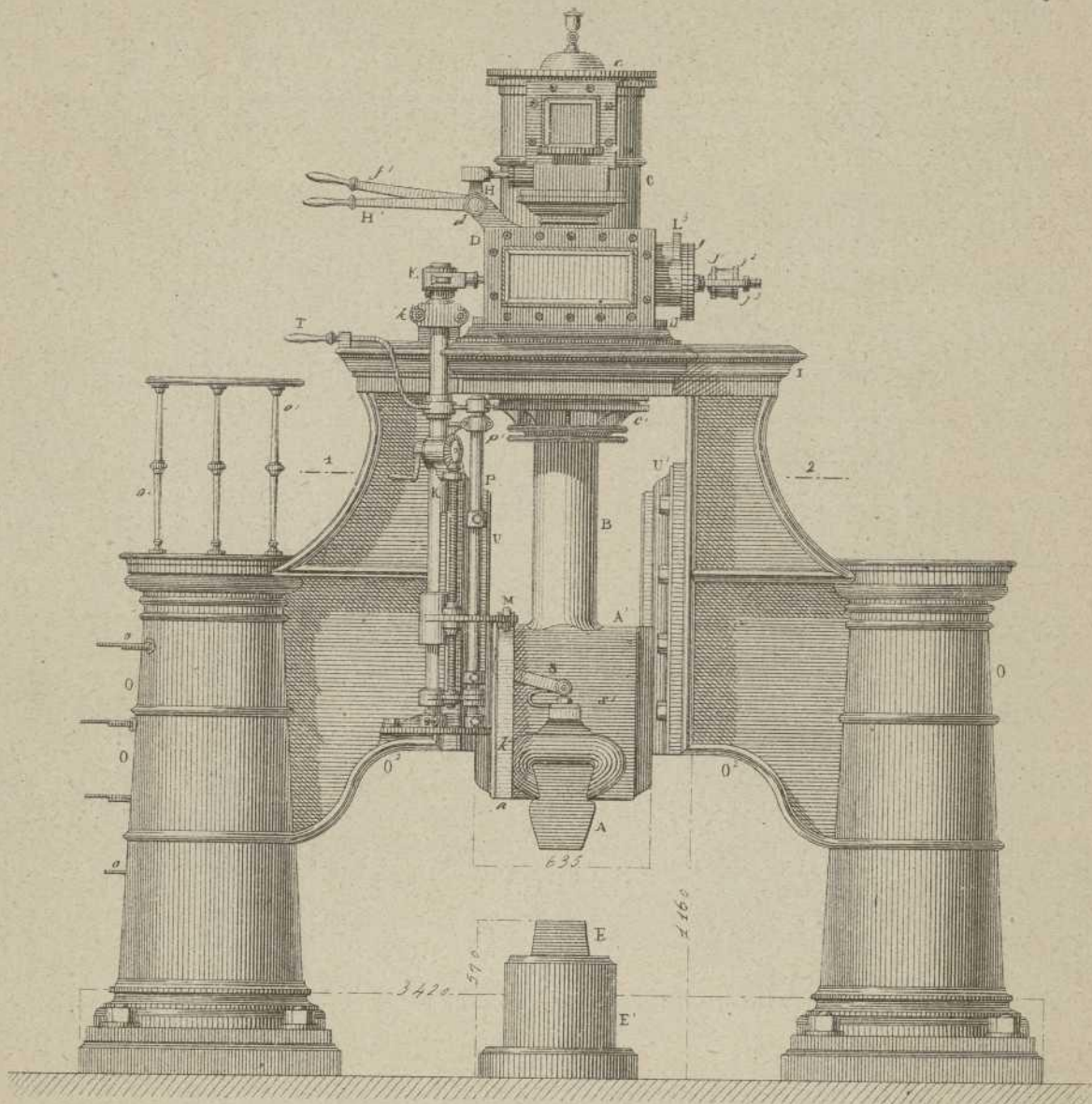
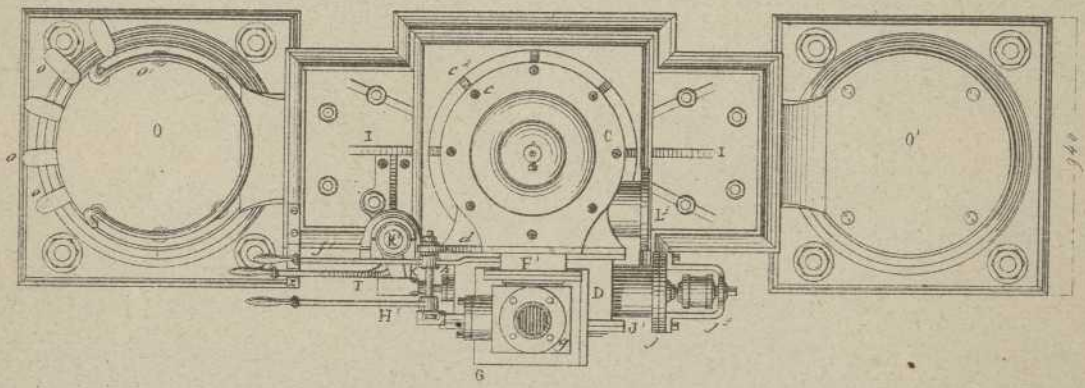


Fig. 2.



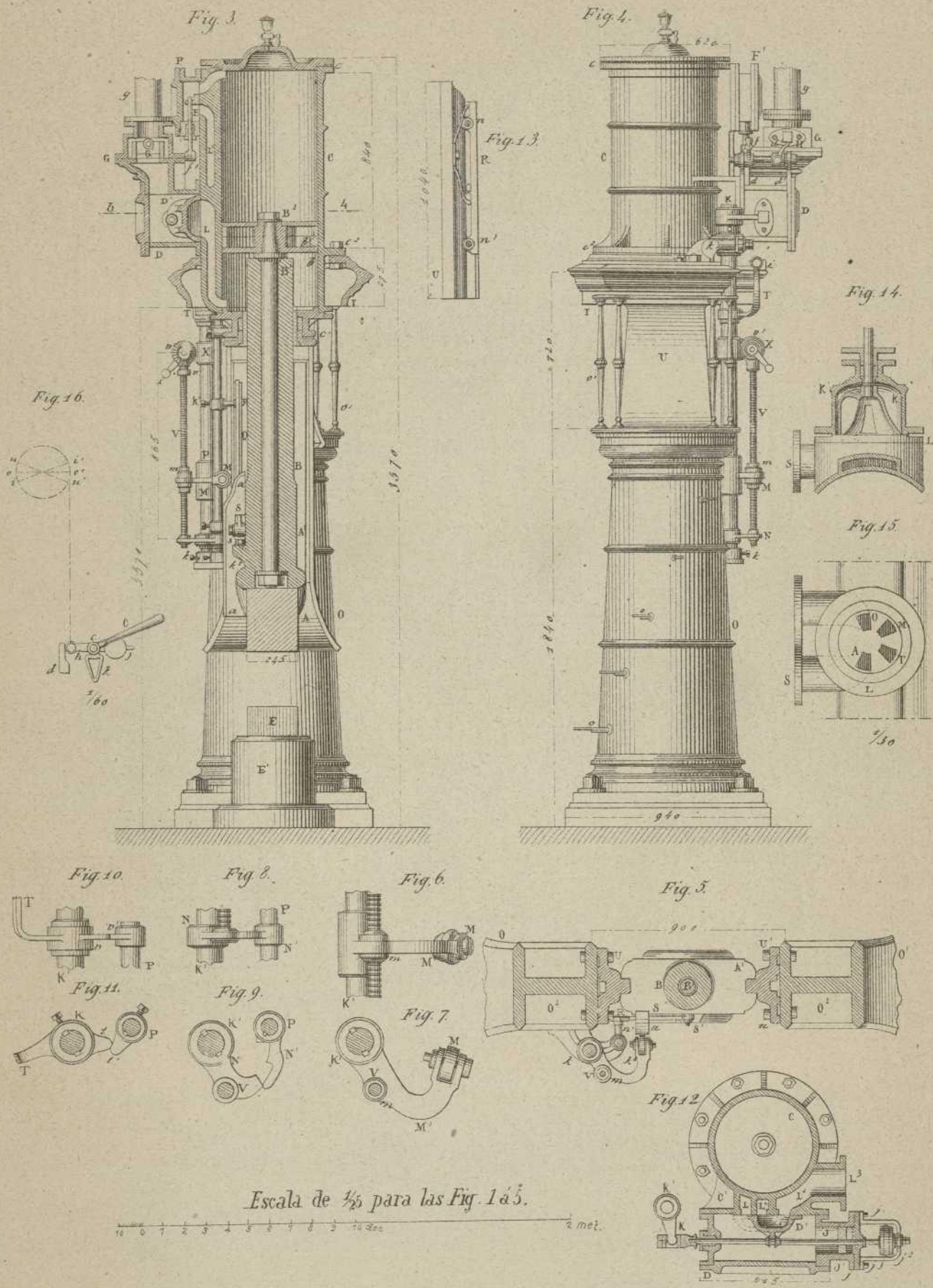


Fig. 1.

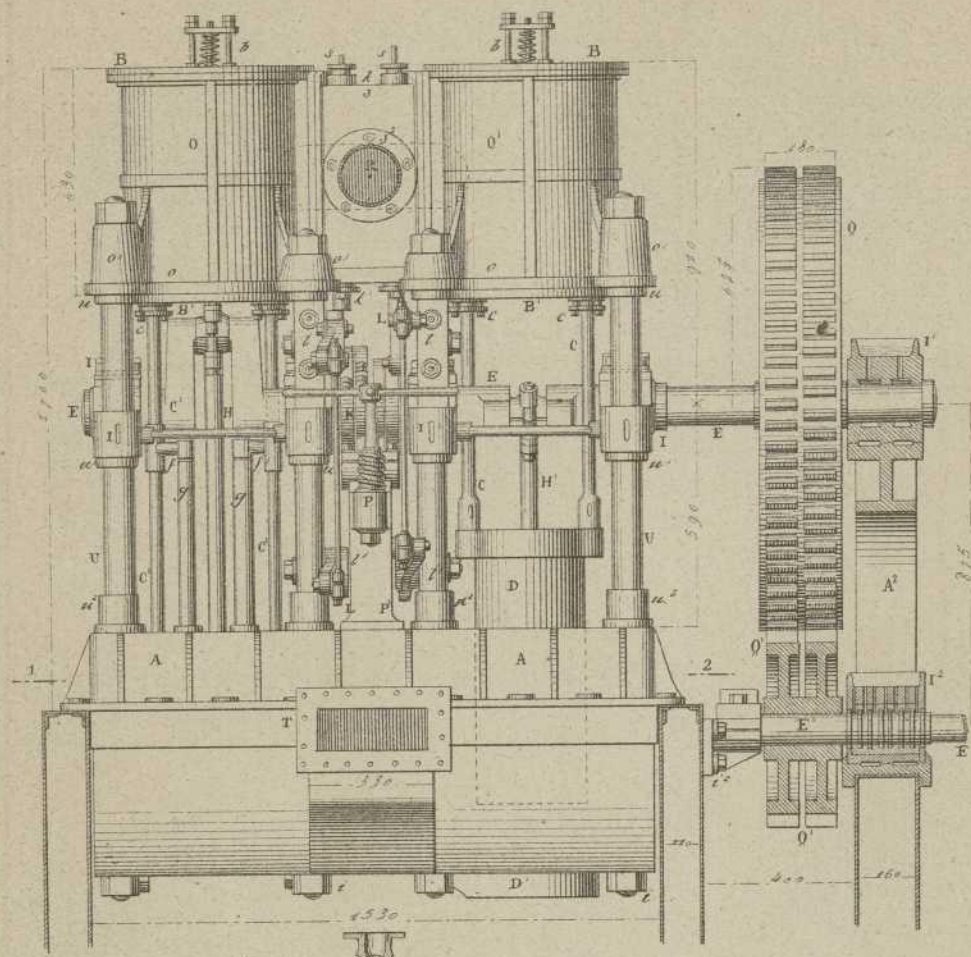


Fig. 5.

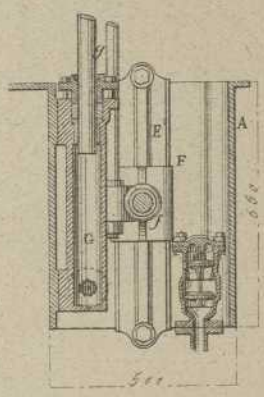


Fig. 15.



Fig. 3.

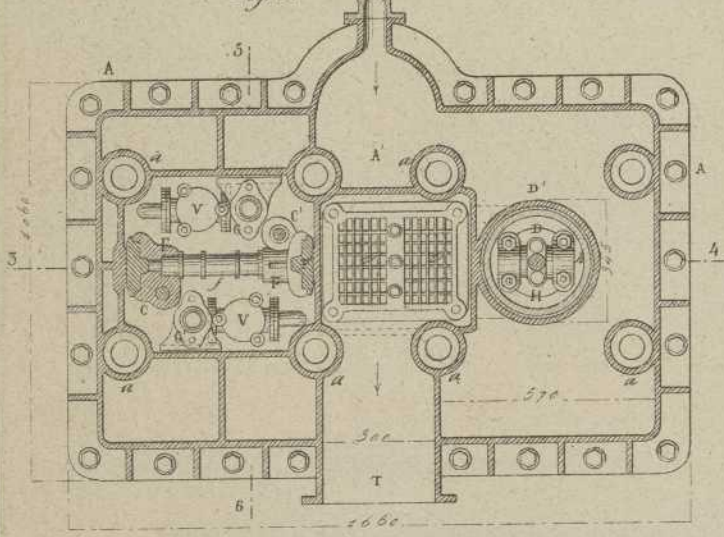
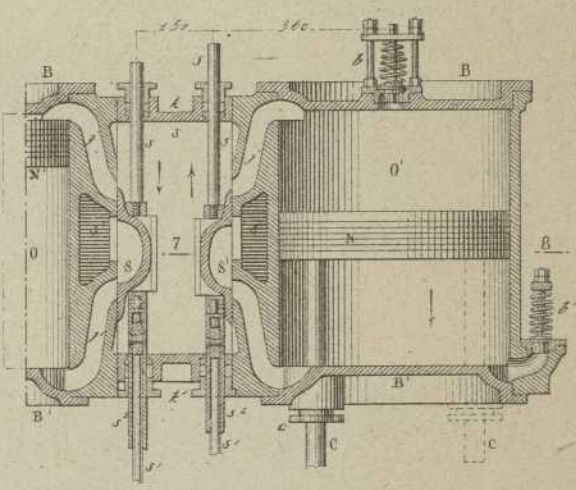


Fig. 6.



Escala de 1/45 por las Fig. 6. á 11.

Fig. 4.

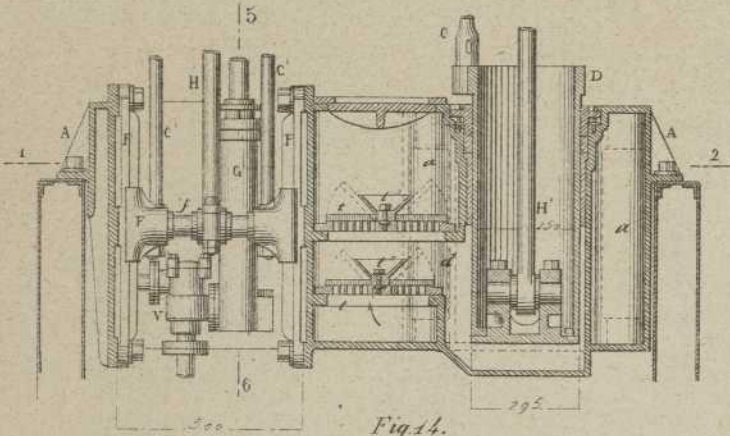


Fig. 4.

Fig. 2.

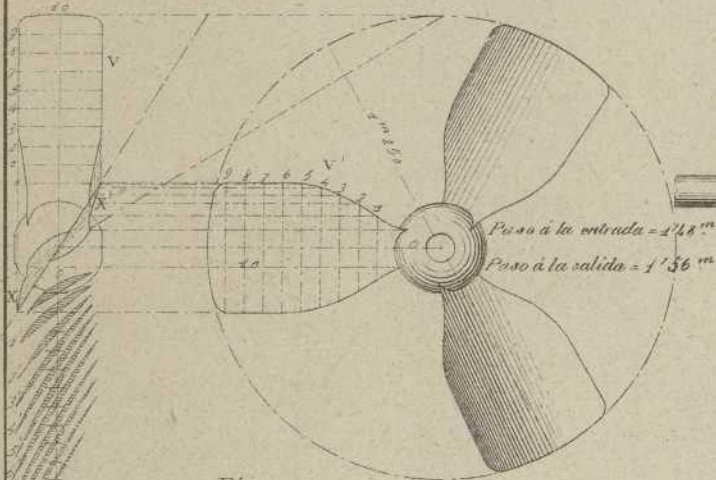
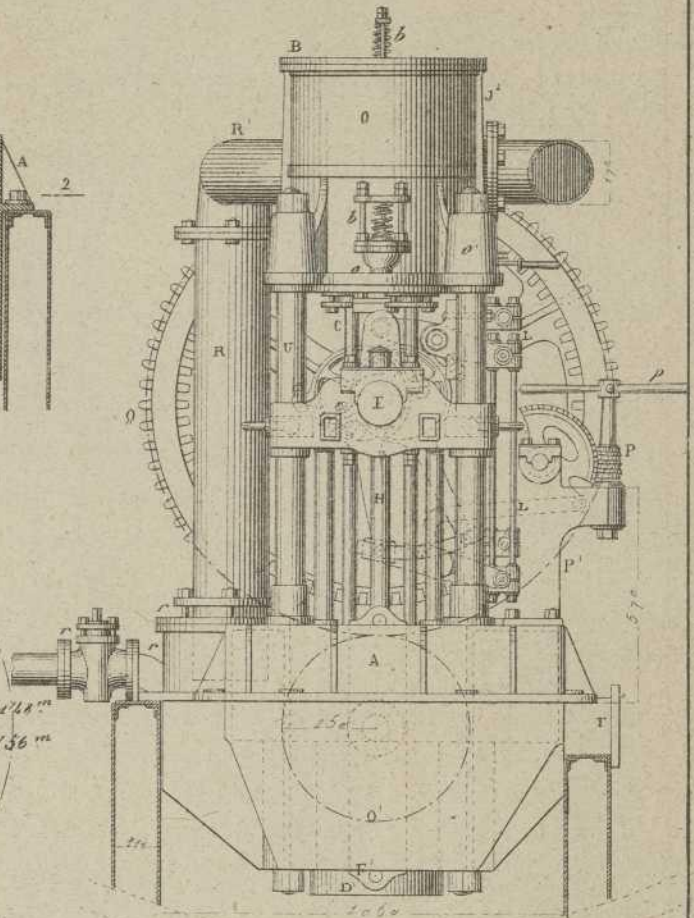


Fig. 9.

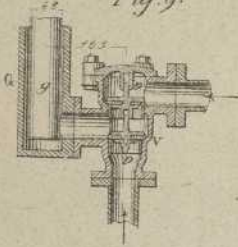


Fig. 8.

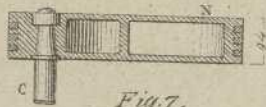


Fig. 7.

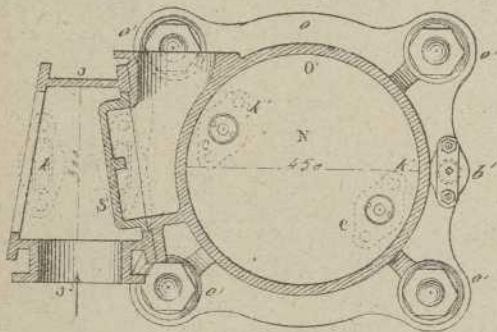


Fig. 10.

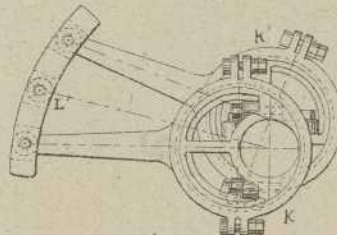


Fig. 11.



Fig. 12.

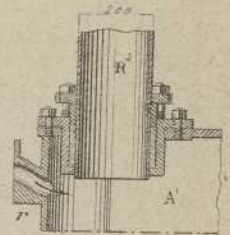
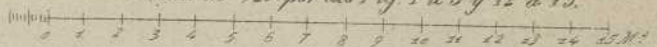
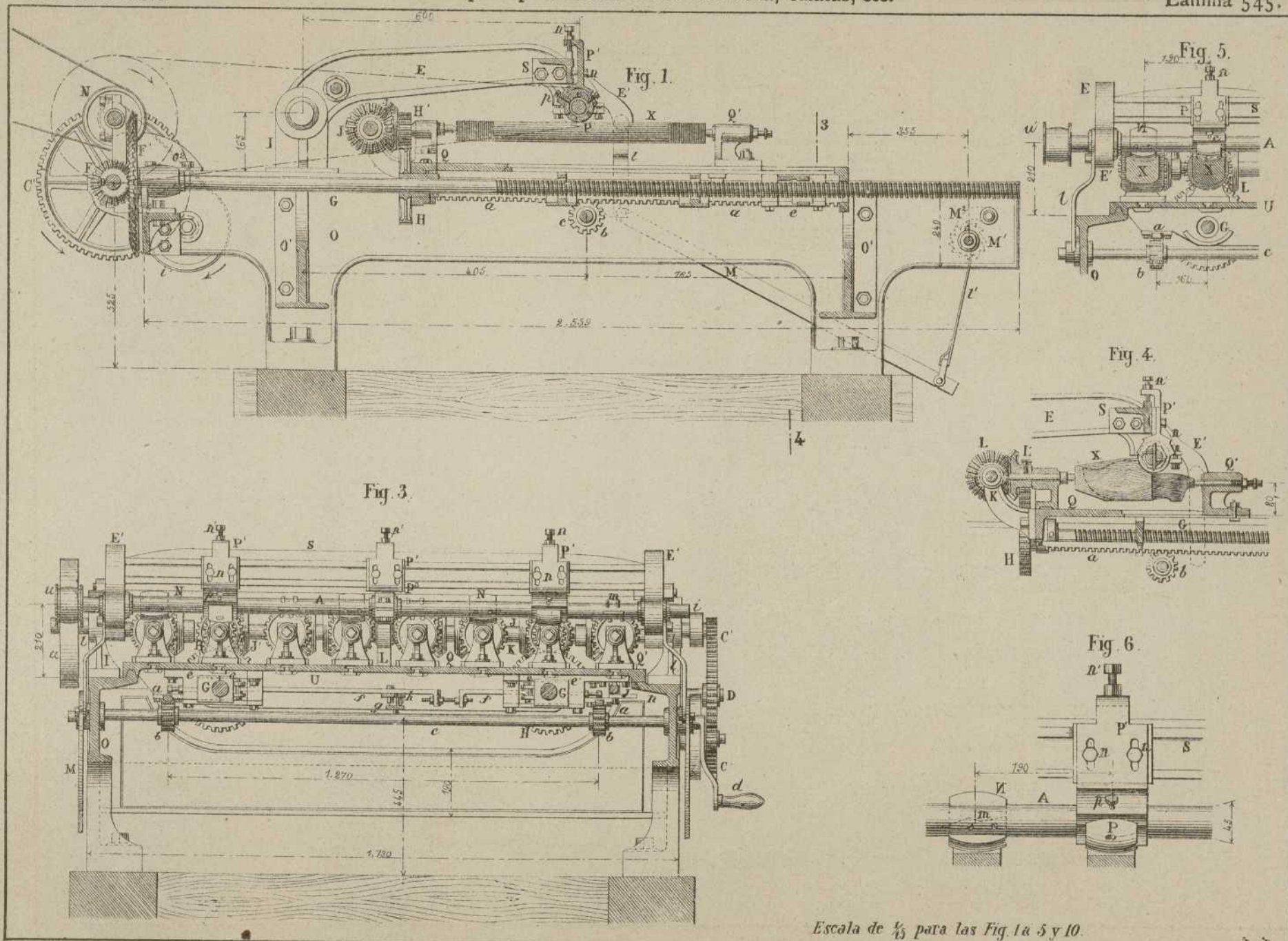


Fig. 13.



Escala de 1/20 por las Fig. 1 á 3 y 12 á 15.





Nacente, editor.

Escala de $\frac{1}{3}$ para las Fig. 1 a 5 y 10.

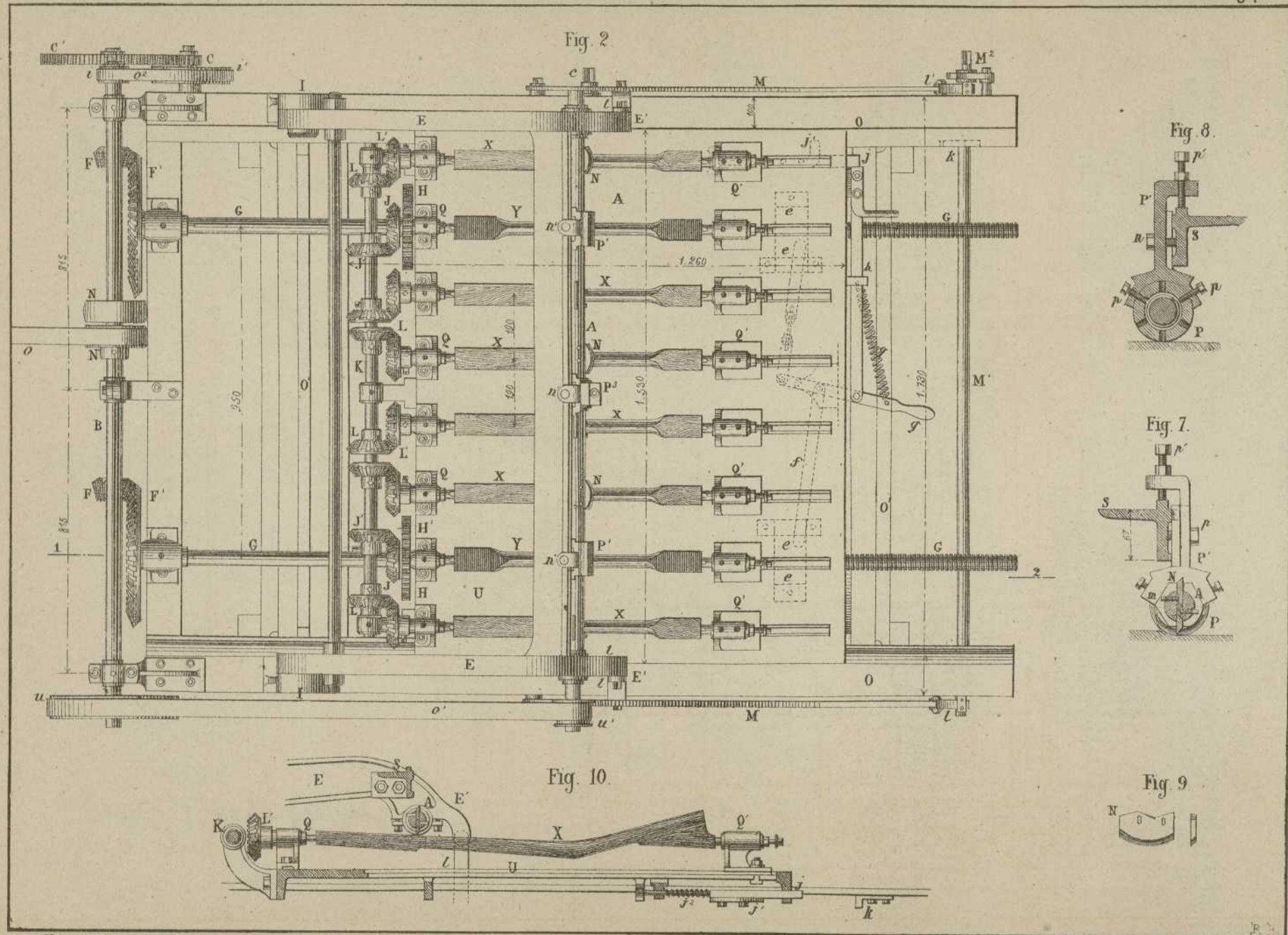
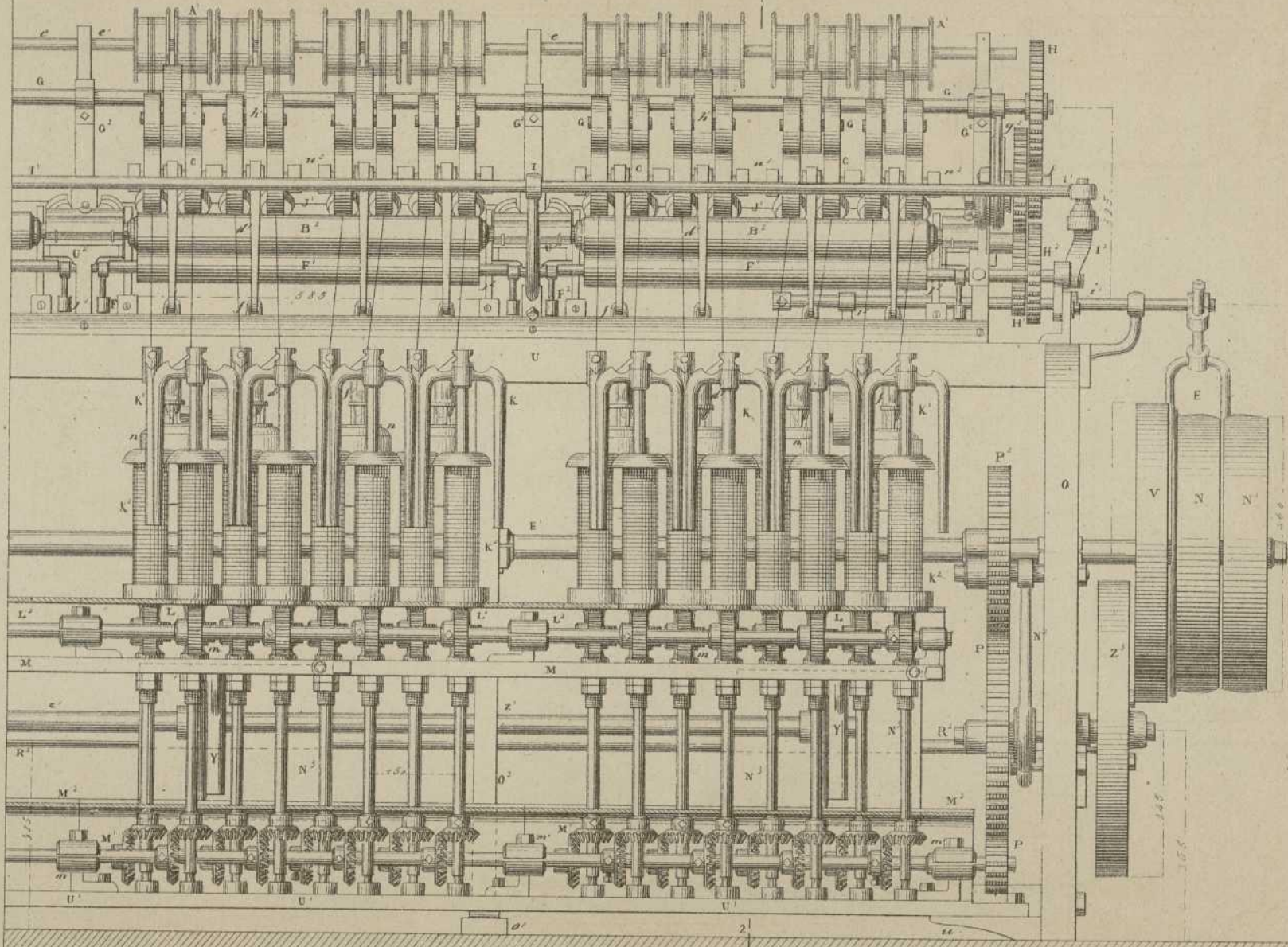


Fig. 1.



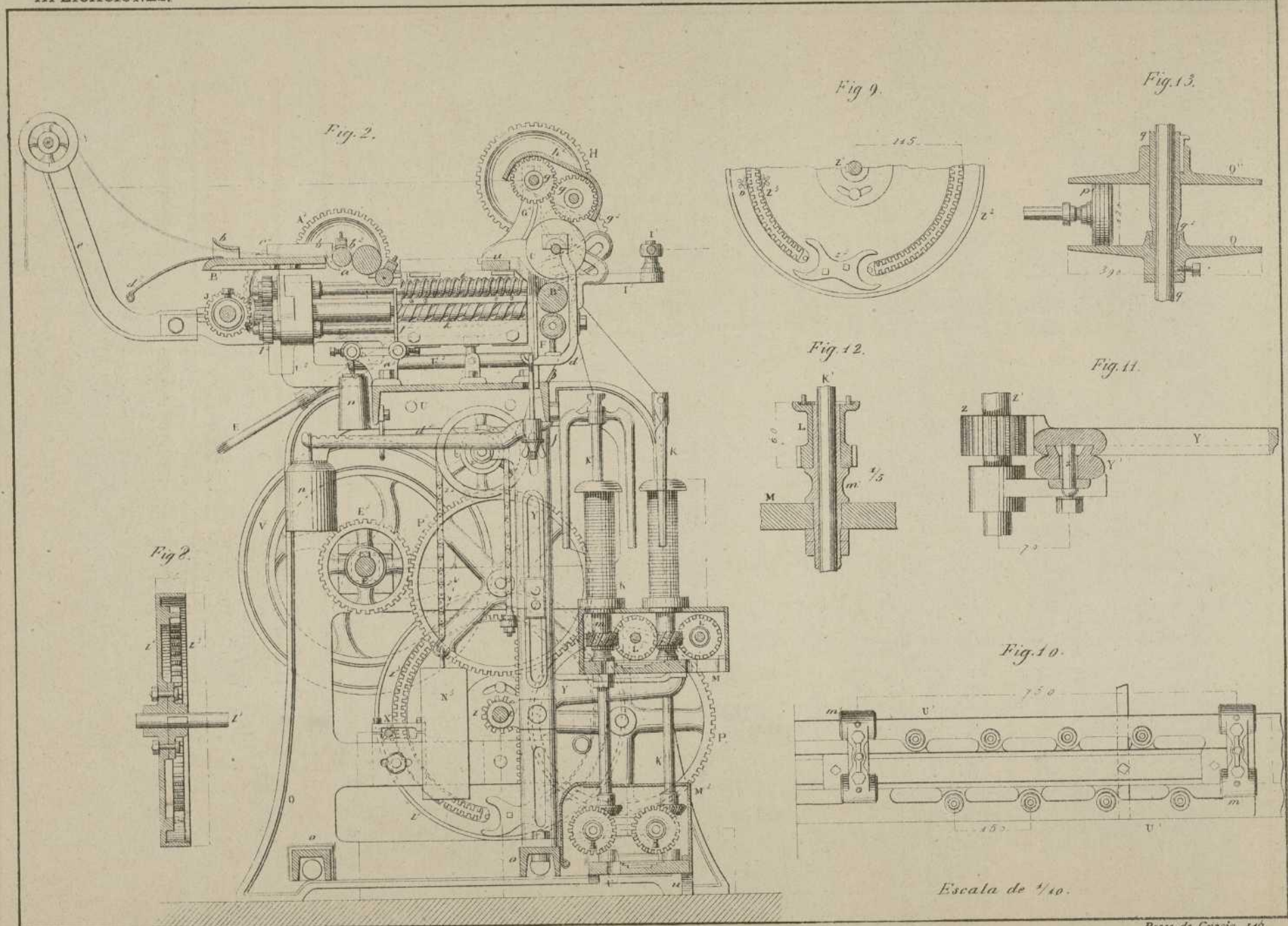


Fig. 3.

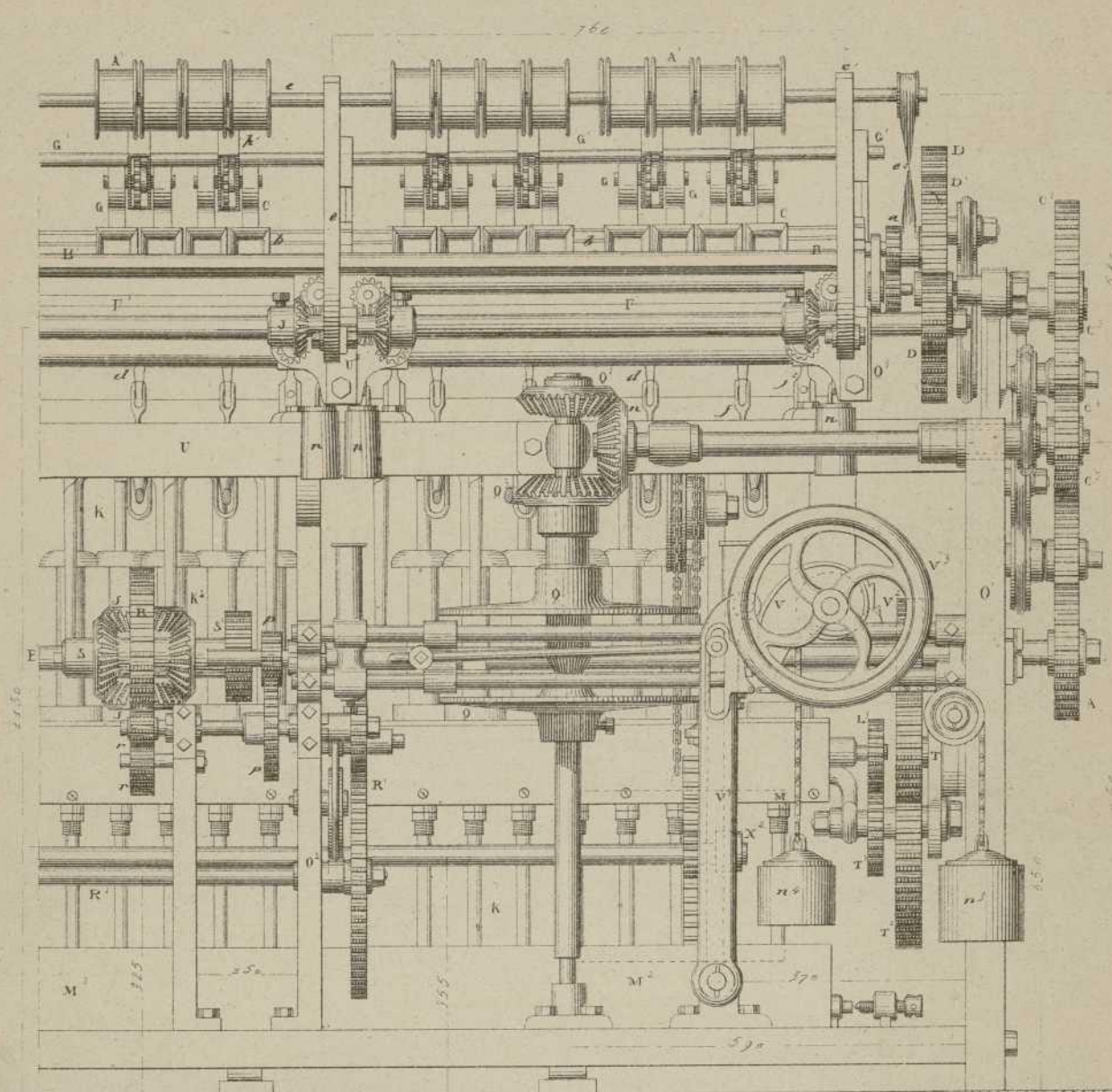


Fig. 13.

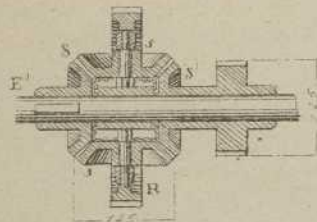
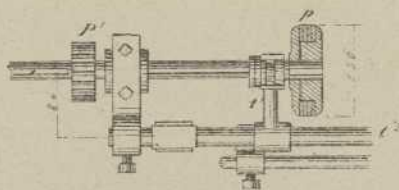


Fig. 14.



Escala de $\frac{1}{10}$

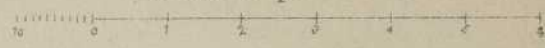


Fig. 4.

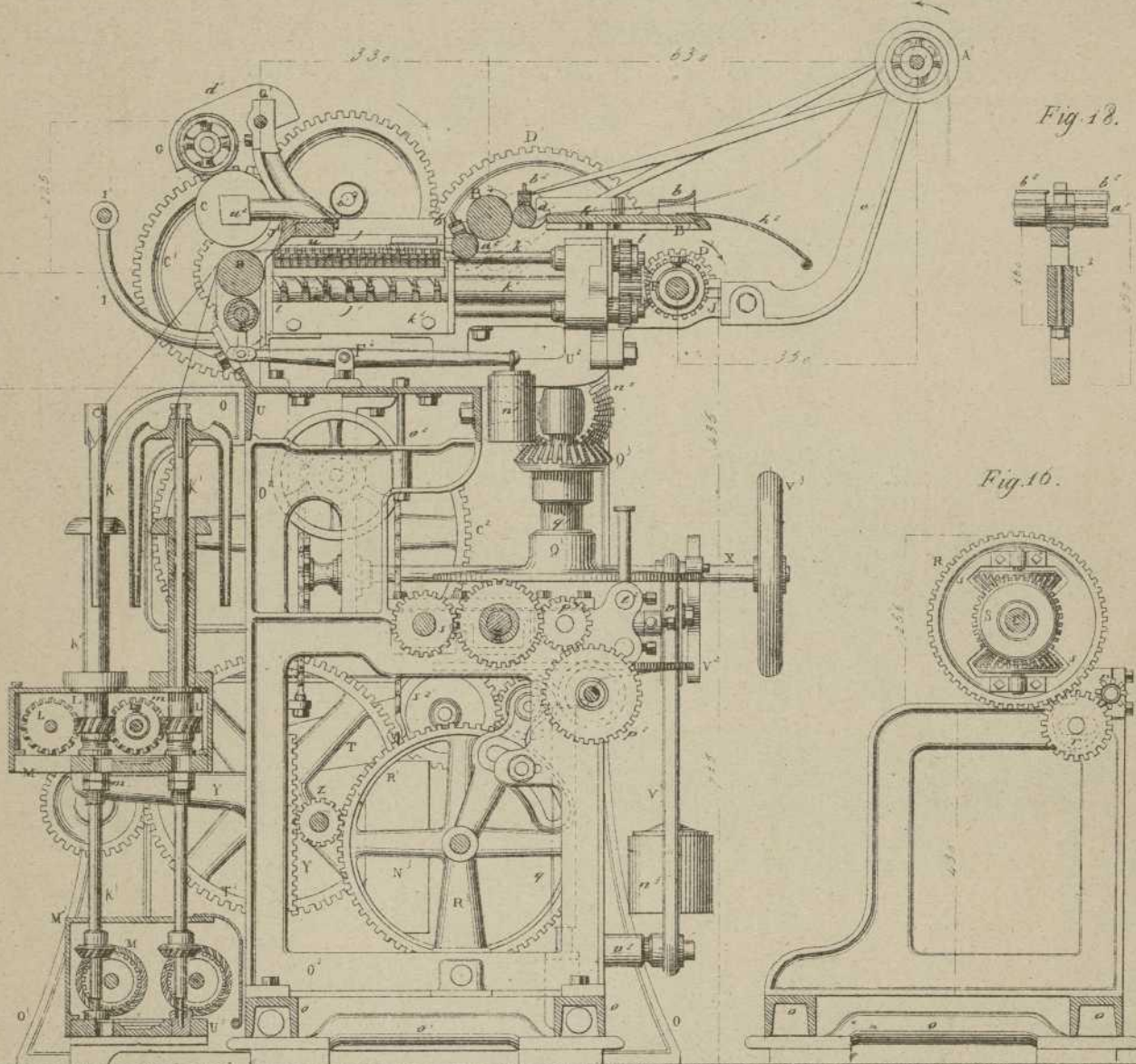
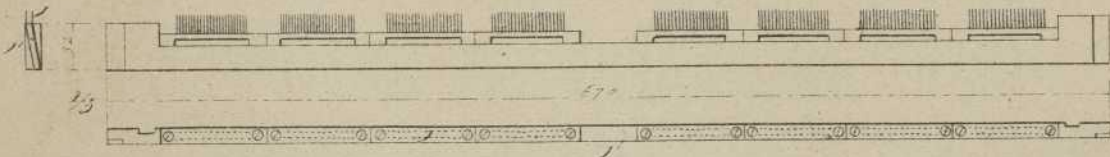
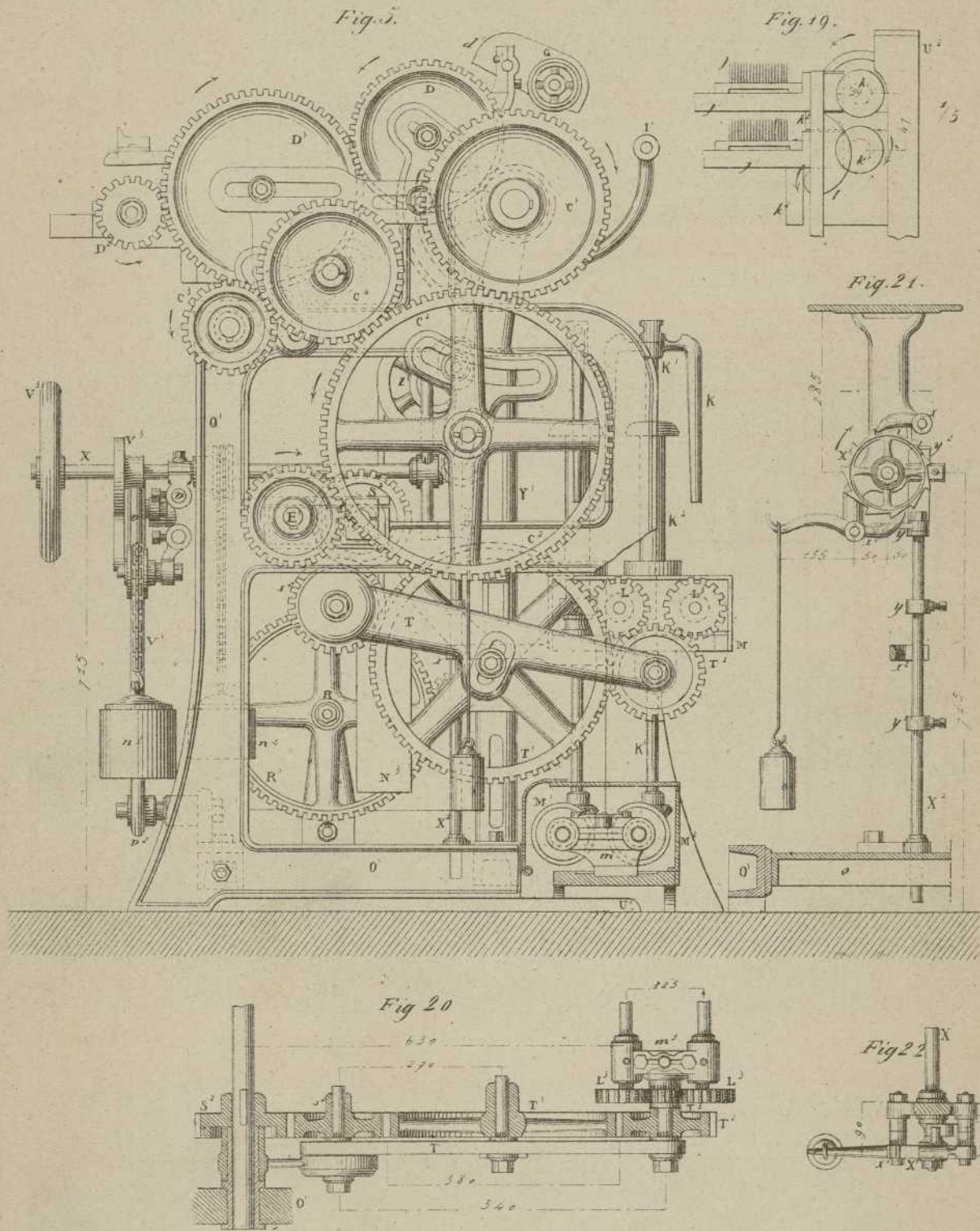


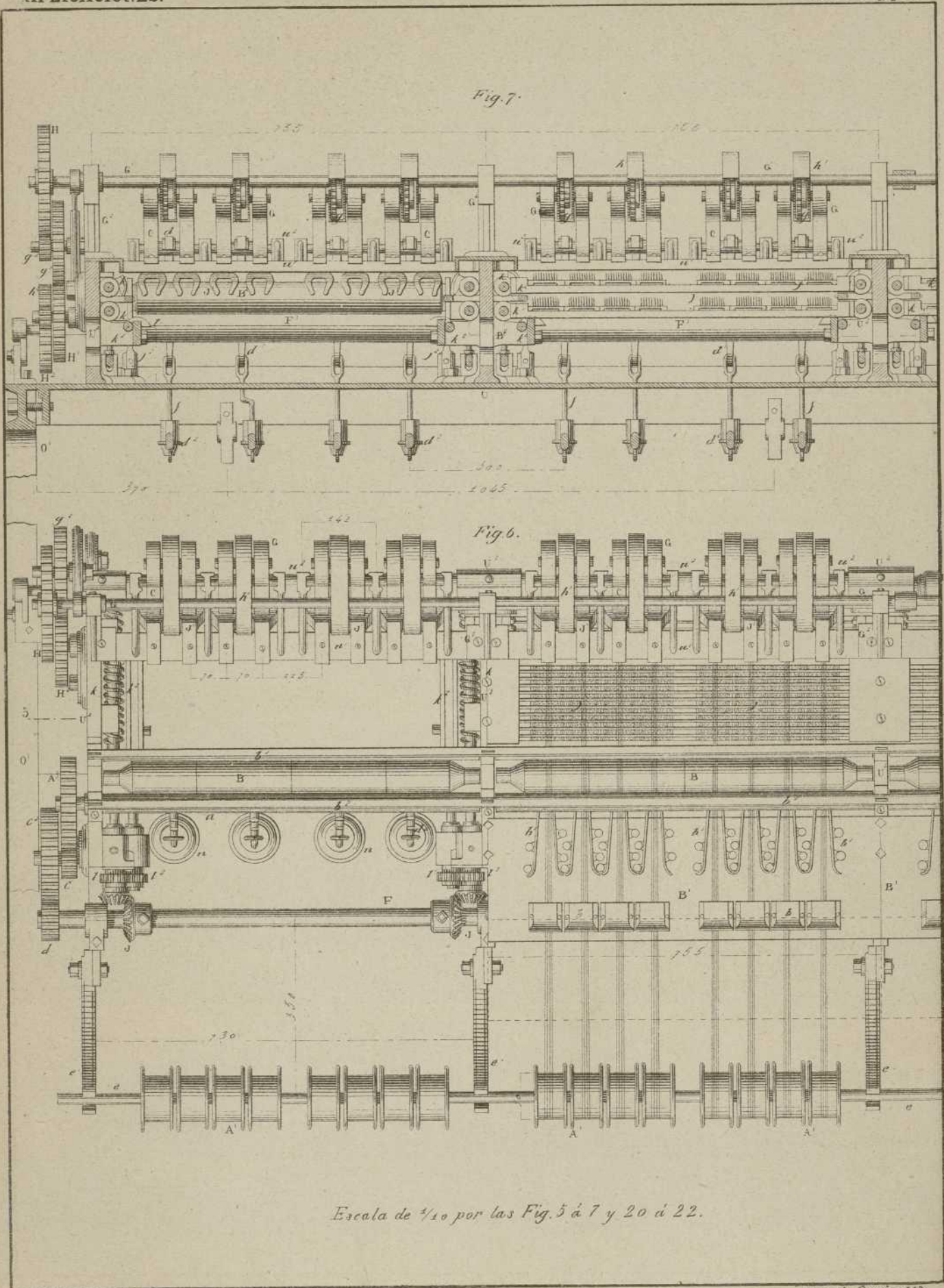
Fig. 13.

Fig. 10.

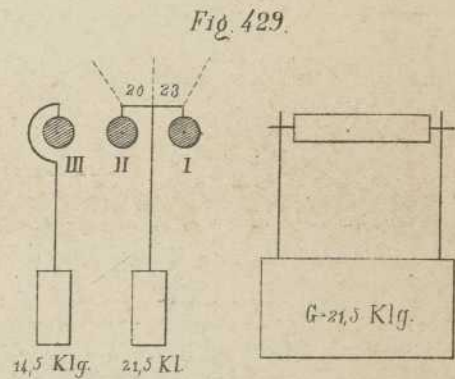
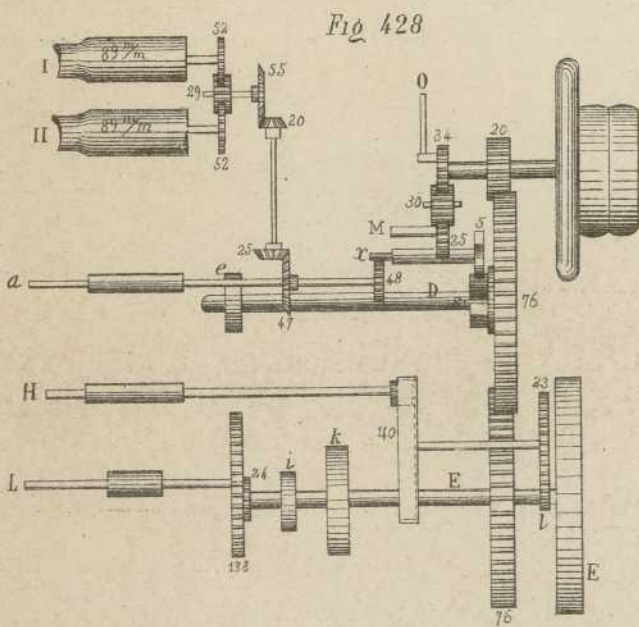
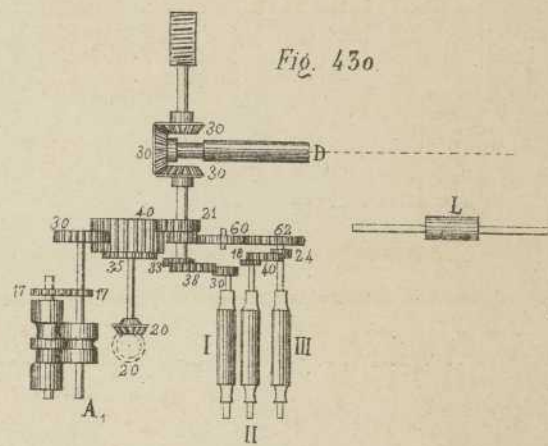
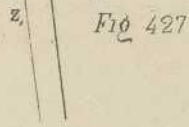
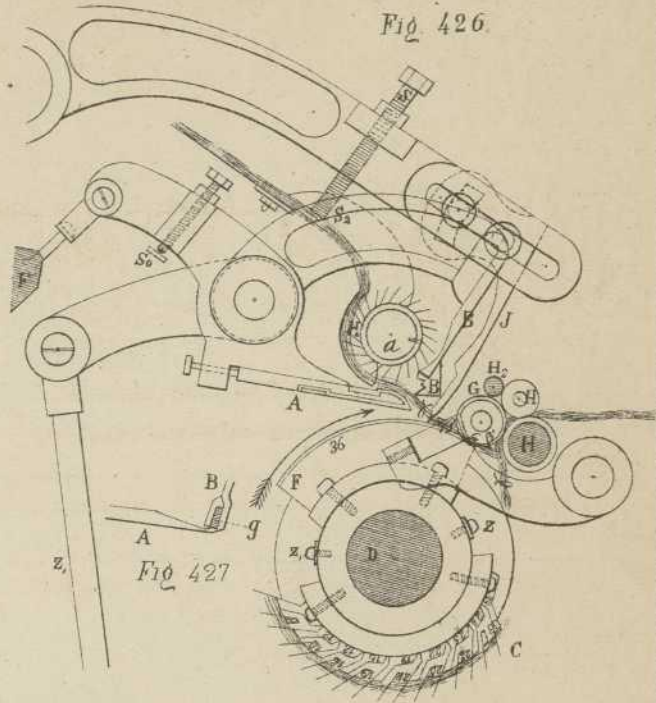
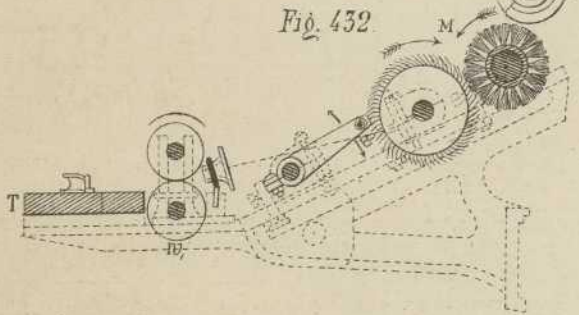
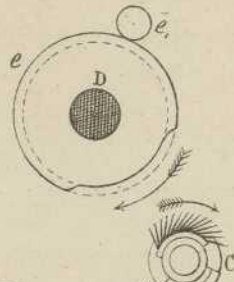
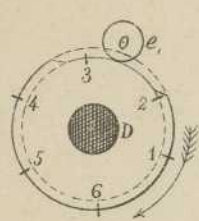
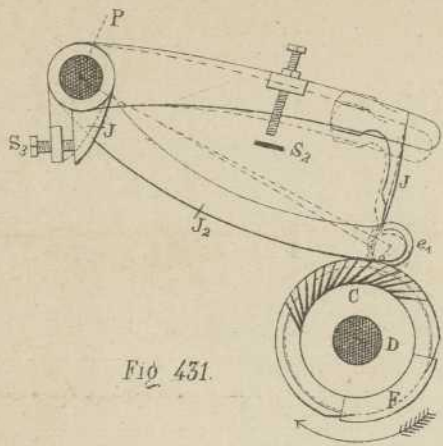
Fig. 17.







Escala de 1/10 por las Fig. 5 á 7 y 20 á 22.



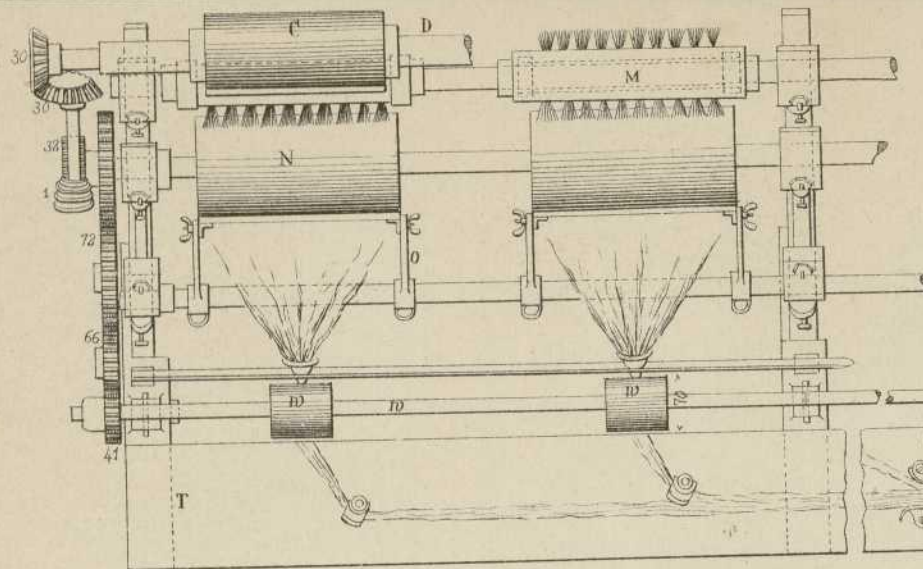


Fig. 433.

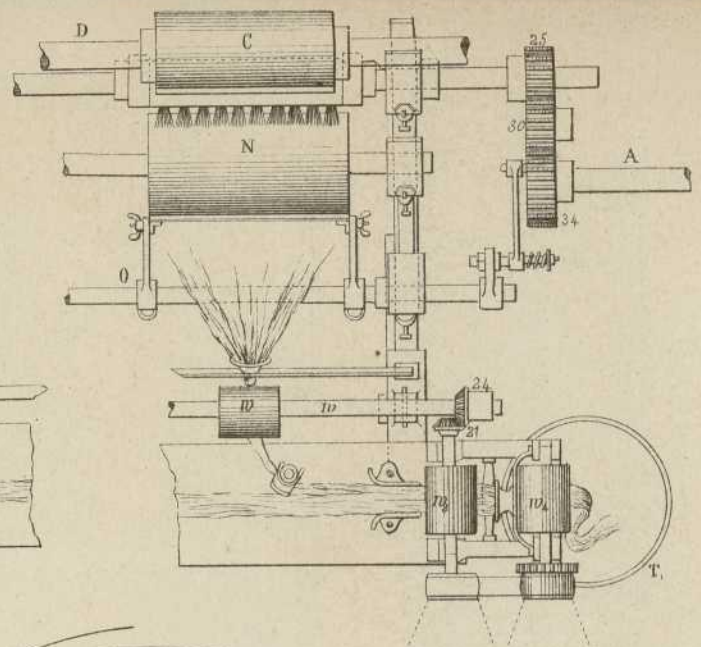


Fig. 435.

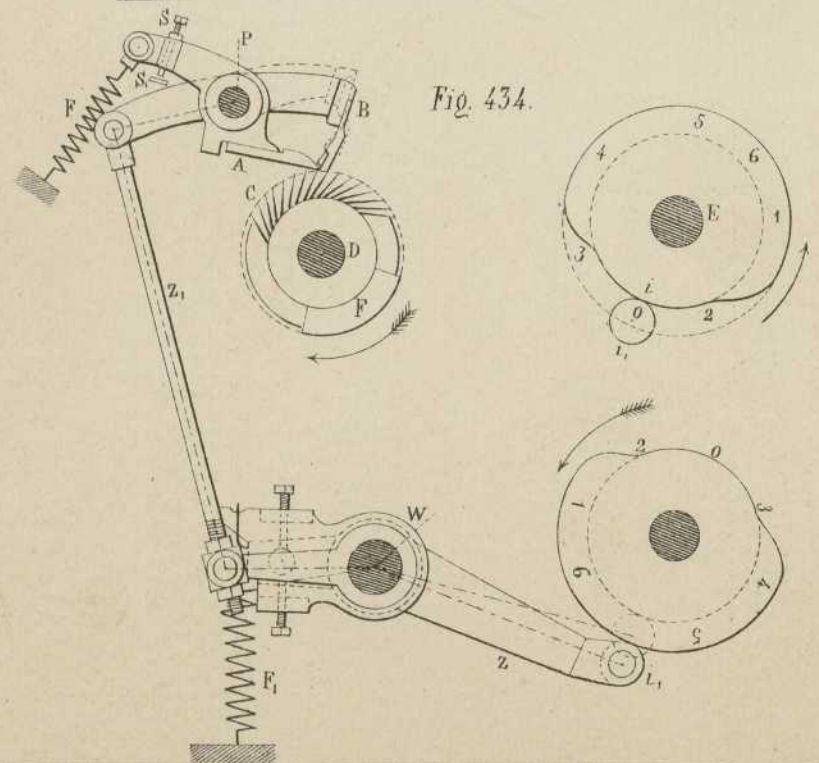


Fig. 434.

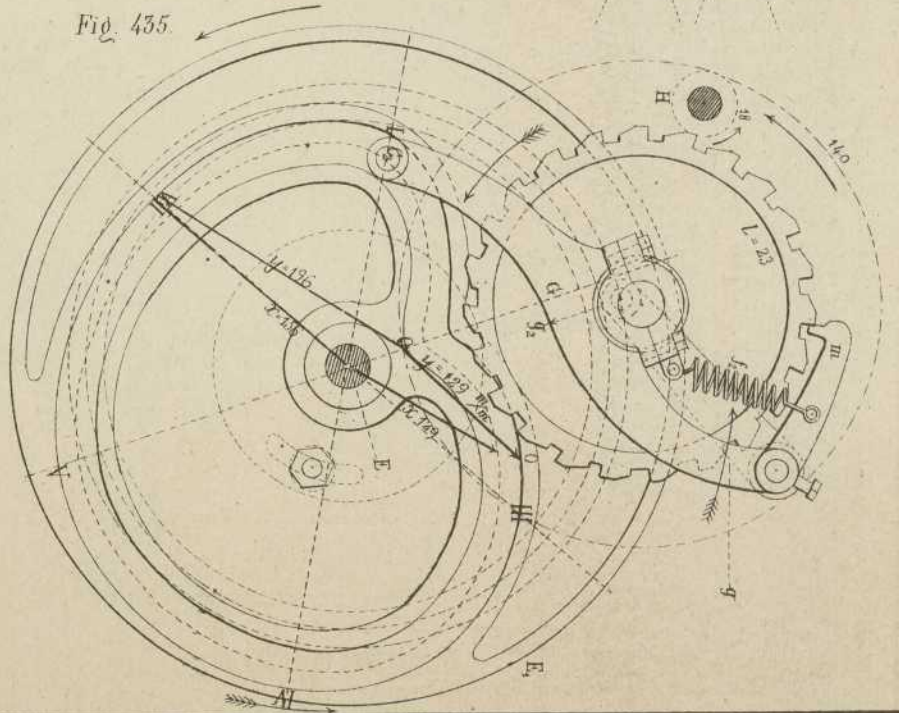
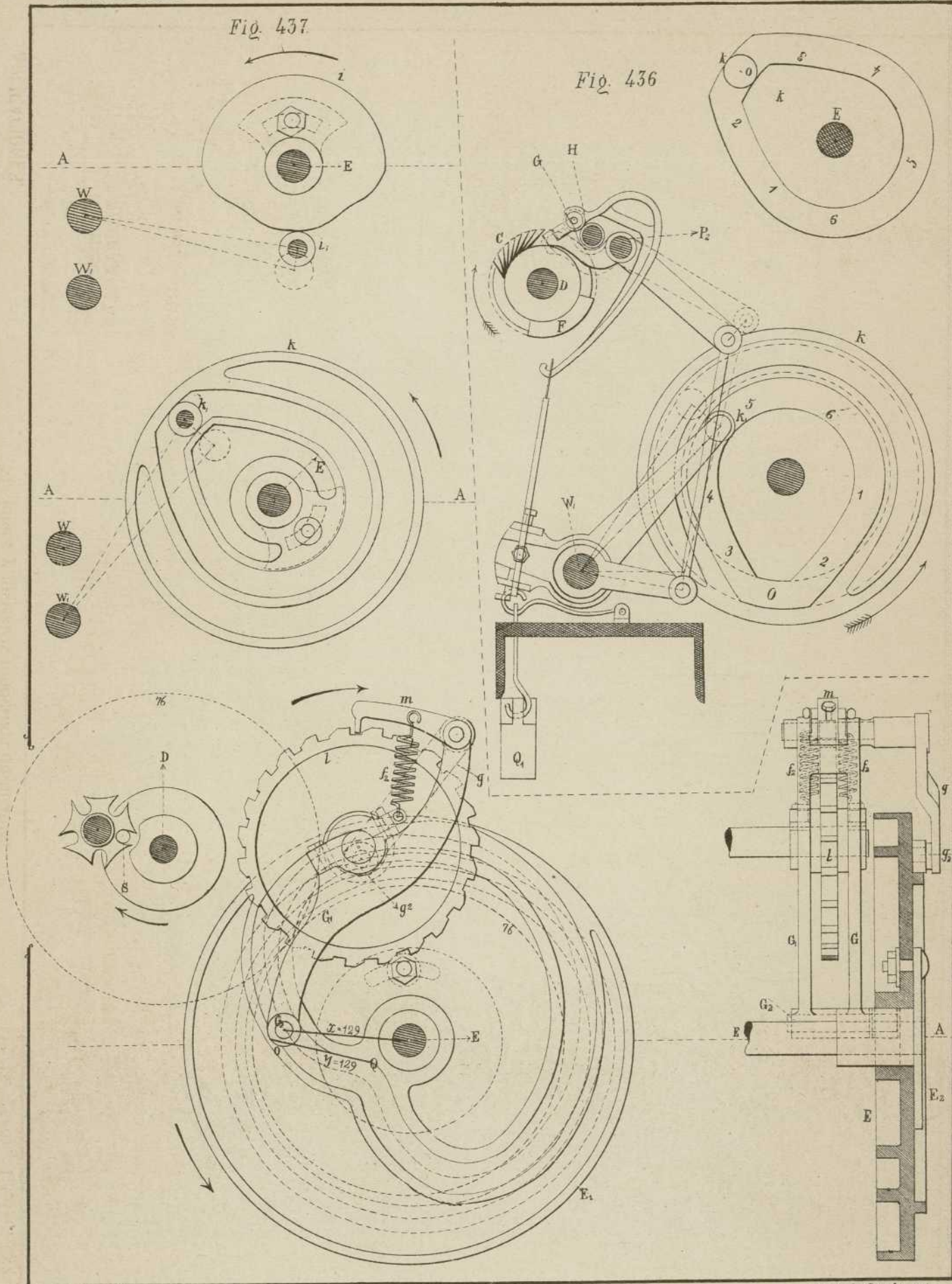


Fig. 437

Fig. 436



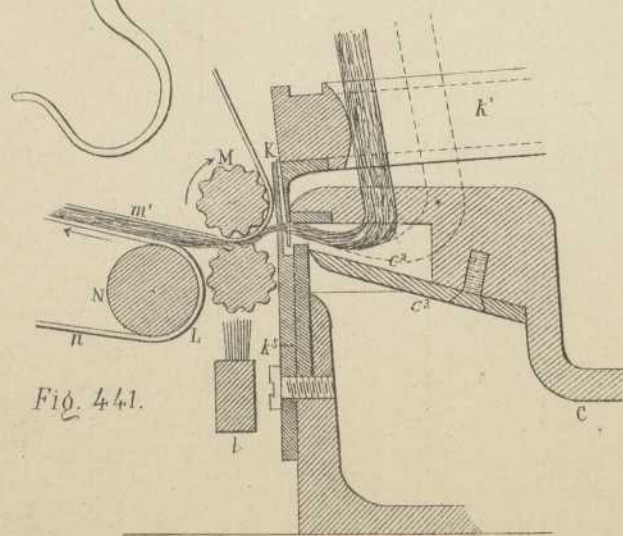
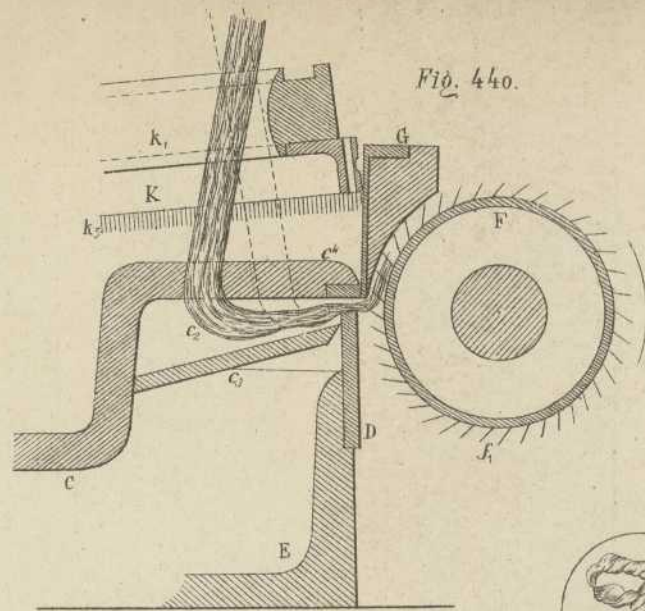
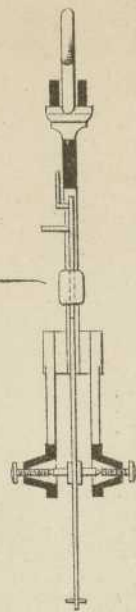
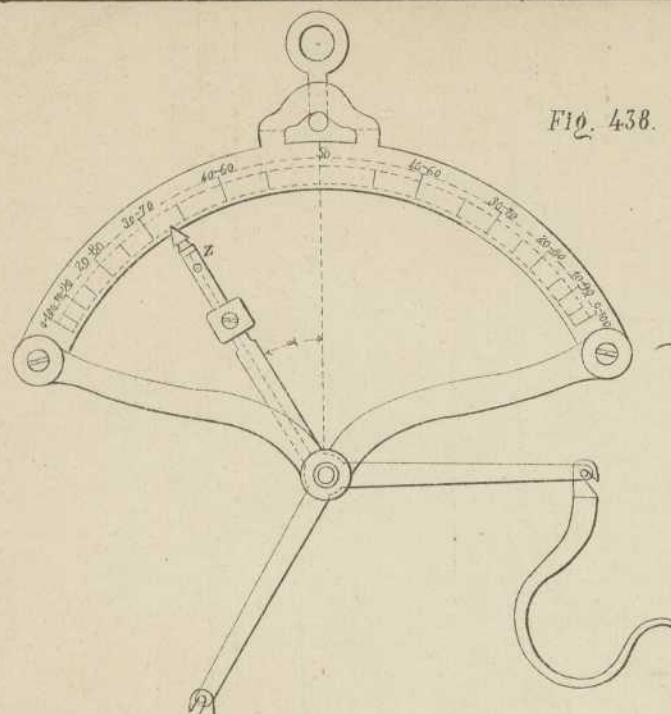


Fig. 439.

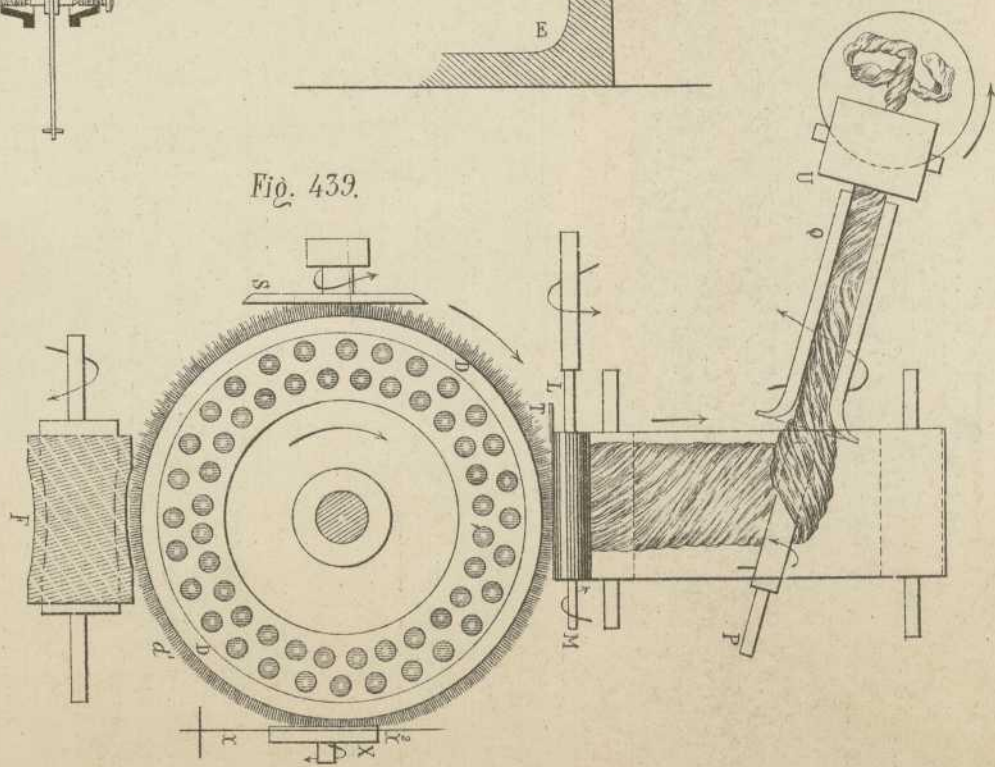
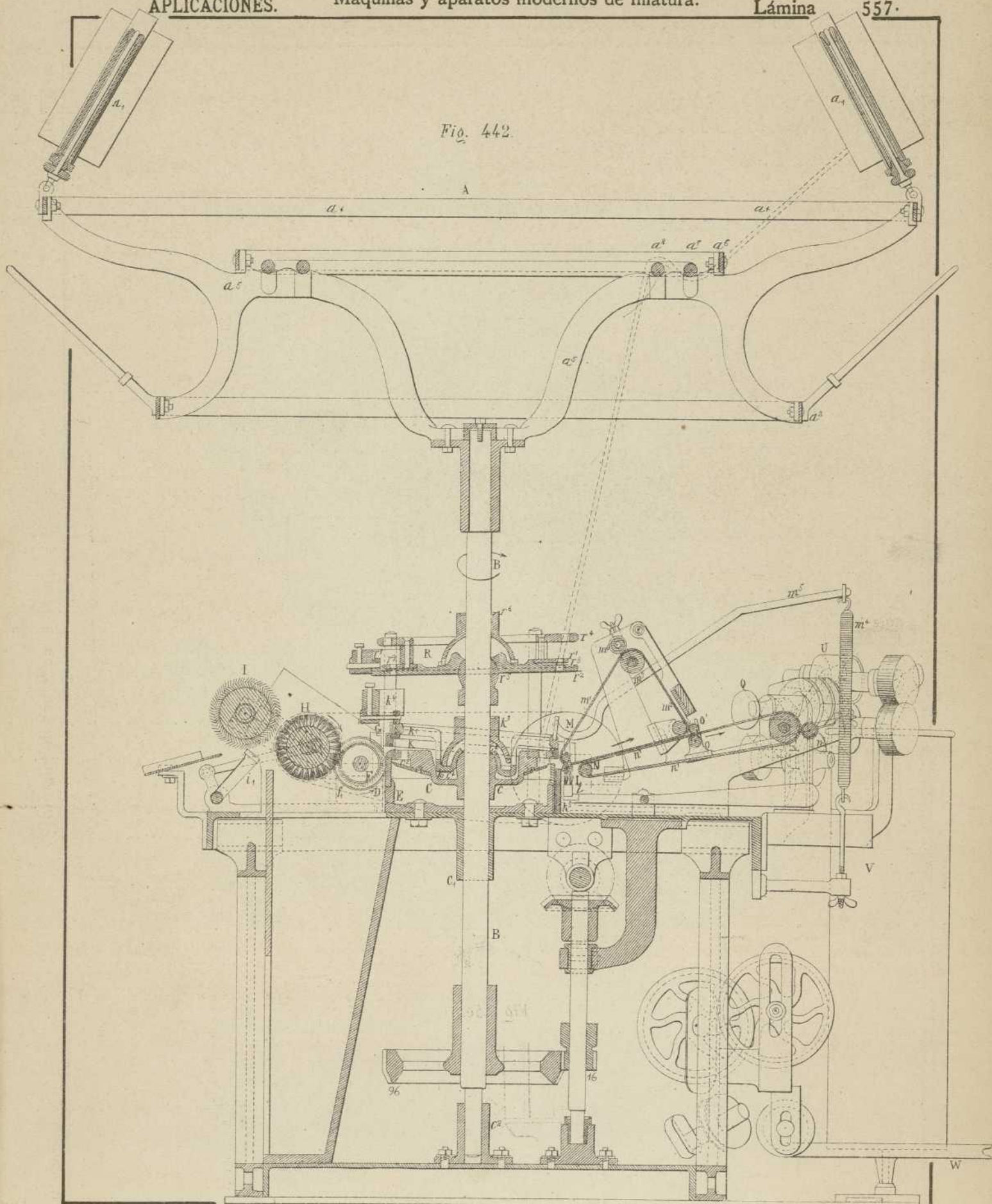


Fig. 442.



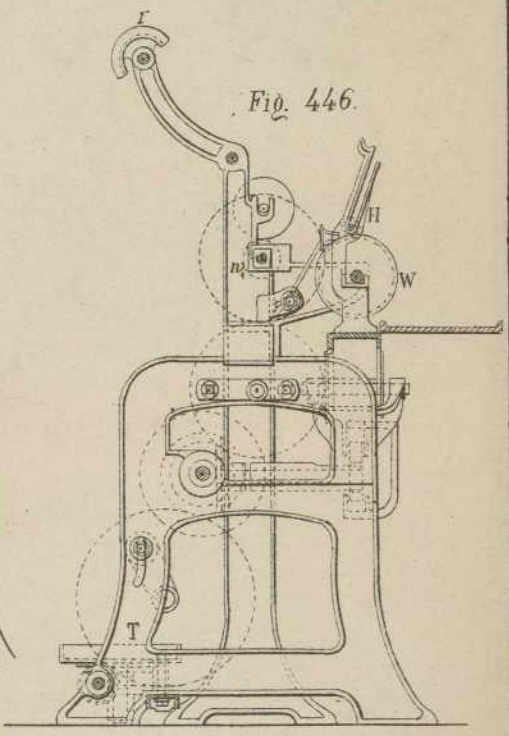
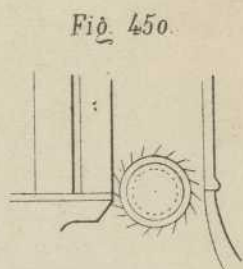
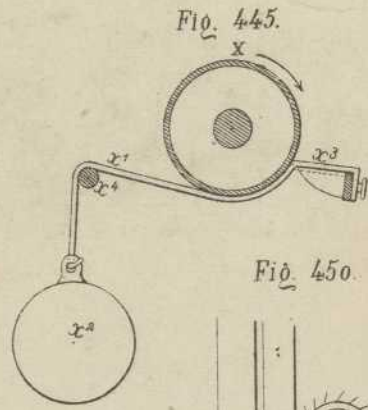
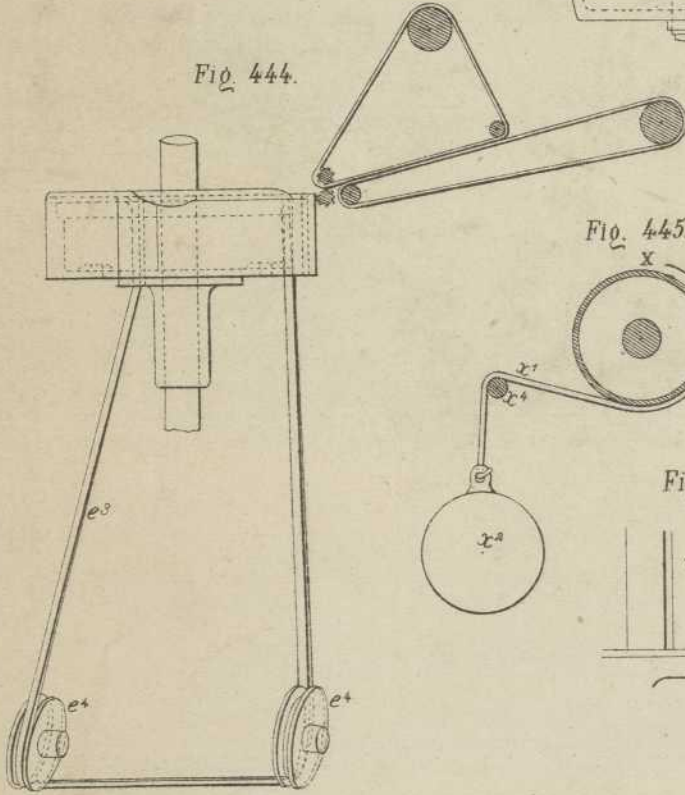
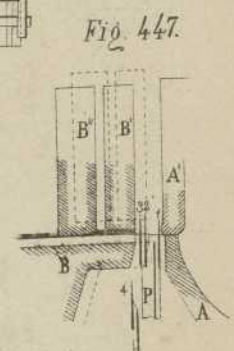
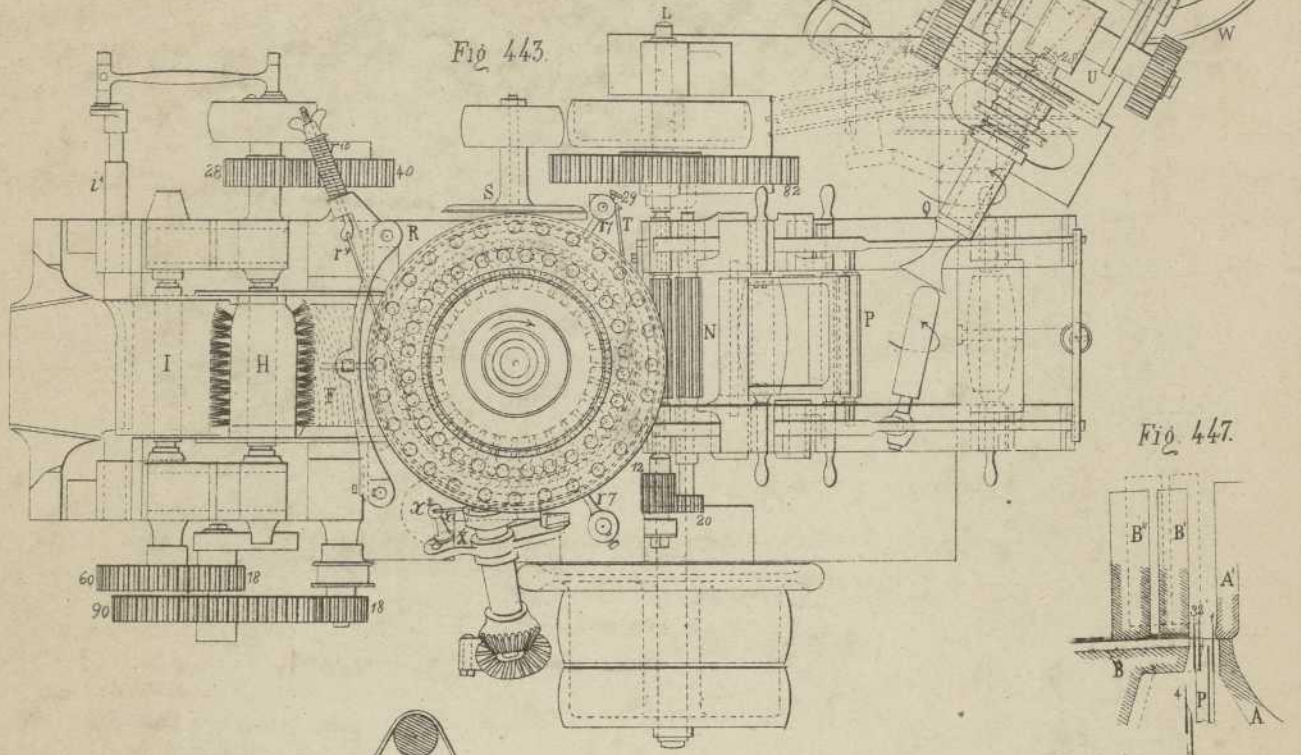
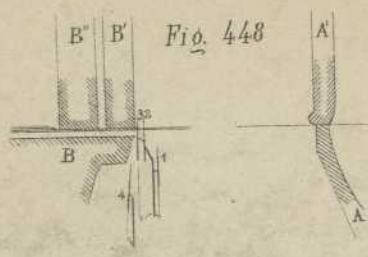
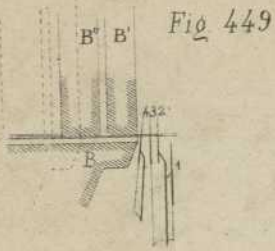


Fig. 451.

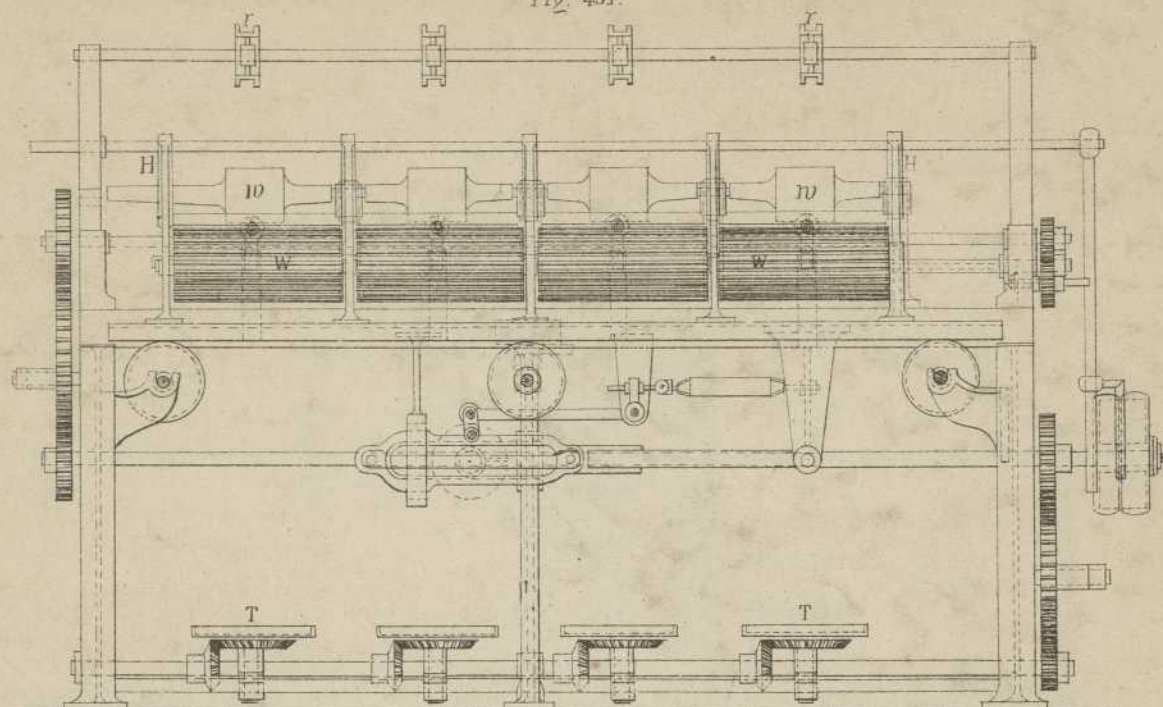


Fig. 452.

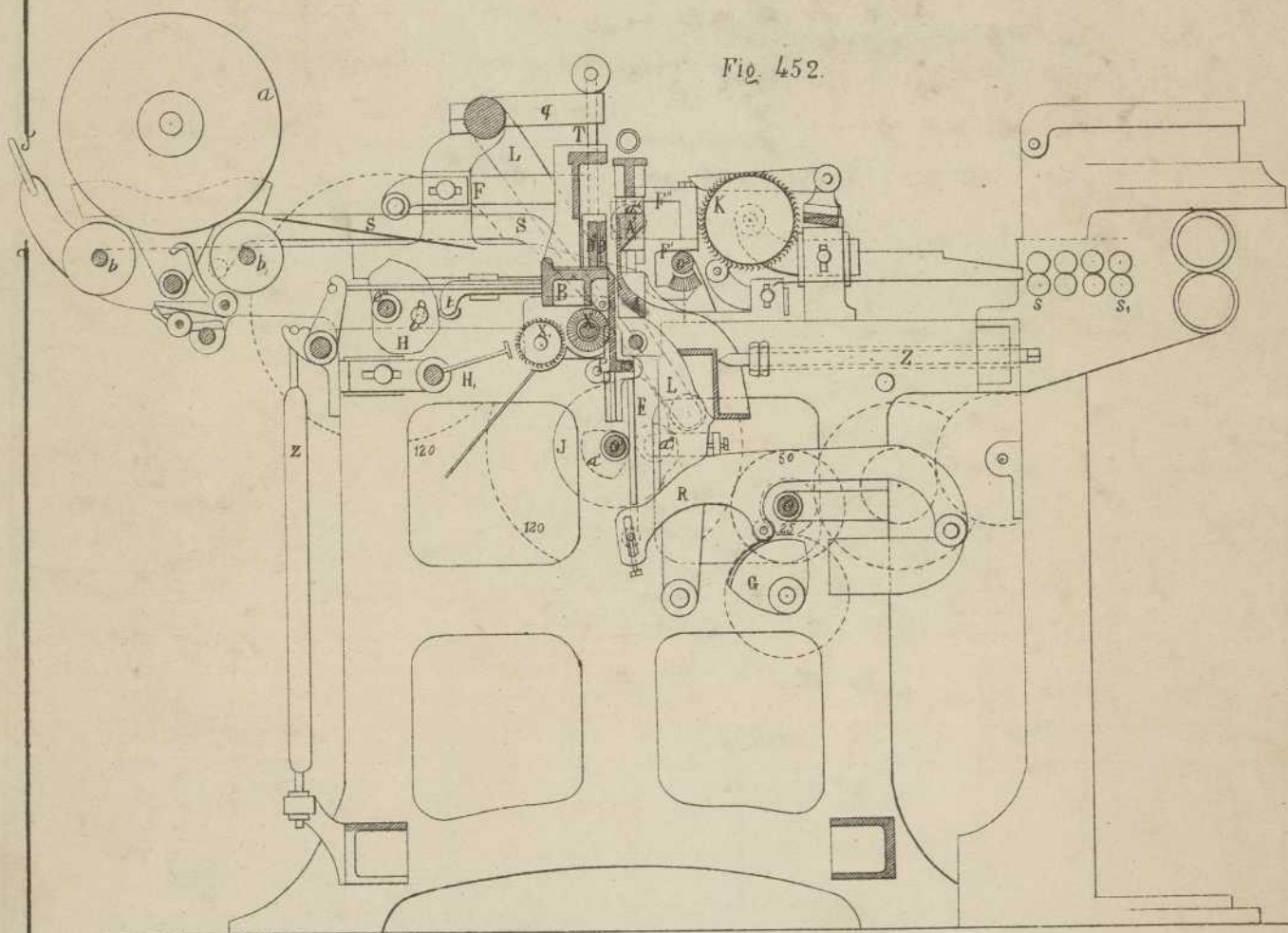


Fig. 453.

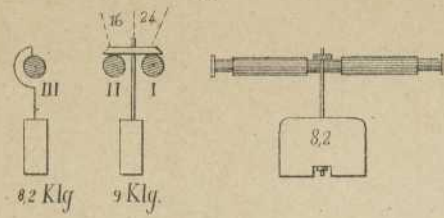


Fig. 455.

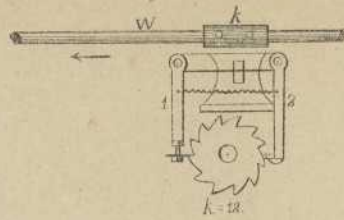


Fig. 456.

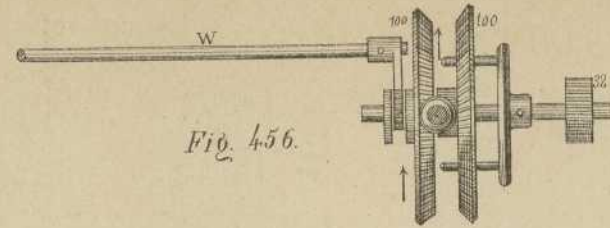
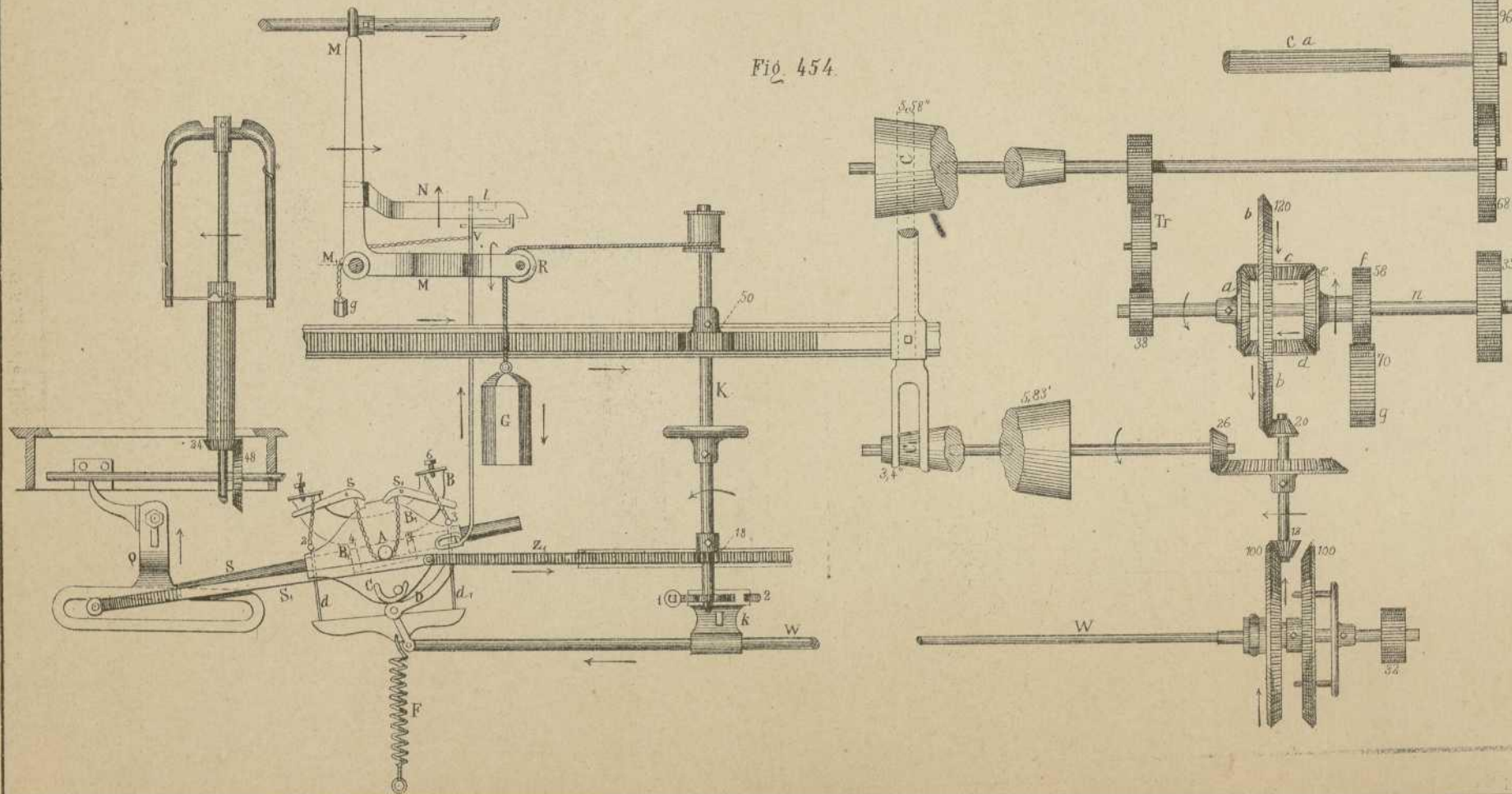


Fig. 454.

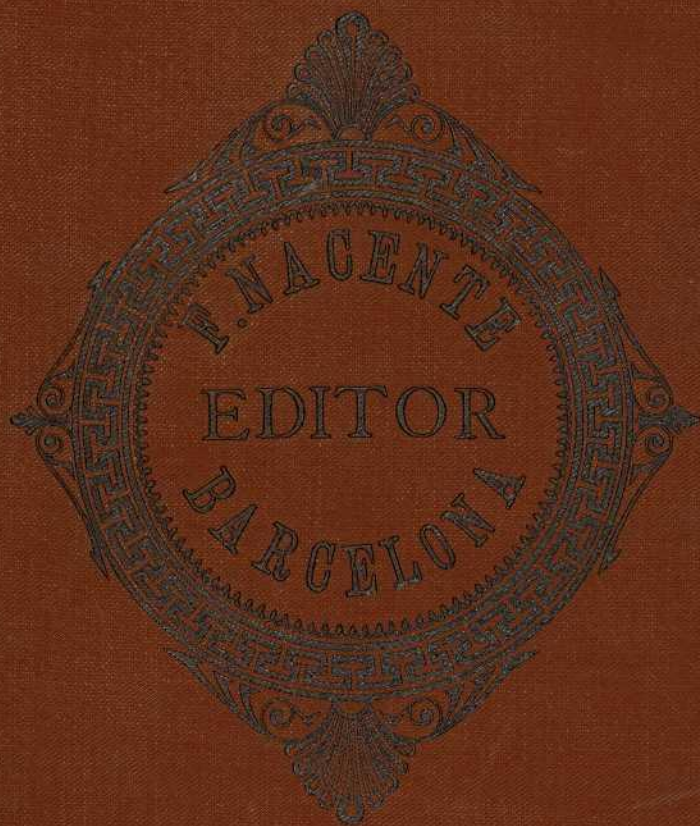


10

ESTANTE 10

Tabla 4.^a

N.º 2



F. REULEUAX

I

MECÁNICA

ATLAS

2

16.458

A. DOMINGO
BARCELONA